

## MCMB-0618 Series

### High Current Molded Power Inductors

#### FEATURES

- Powder iron core material
- Magnetically shielded, low EMI
- High current carrying capacity, Low core losses
- Frequency range up to 3MHz
- Operate temperature range ....  $-40^{\circ}\text{C} \sim +125^{\circ}\text{C}$  (Including self temp. rise)
- RoHS compliant

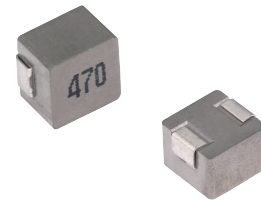

#### APPLICATIONS

- Voltage Regulator Module (VRM)
- Multi-phase regulators
- Point-of-load modules
- Smart phone POL modules
- SSD modules
- Notebook regulators
- Battery power systems
- Graphics cards
- Data networking and storage systems

#### Explanation of Part Number

MCMB -0618 -1R0 M T

1 2 3 4 5

- ◆ 1:Product Series: Metal Alloy Molding Power Inductor
- ◆ 2:Dimensions:
- ◆ 3: Initial inductance value: 1R0 = 1.0uH
- ◆ 4:Tolerance of Inductance:M:±20%
- ◆ 5:Packing:Tape Carrier Package

## Dimensions: [mm]

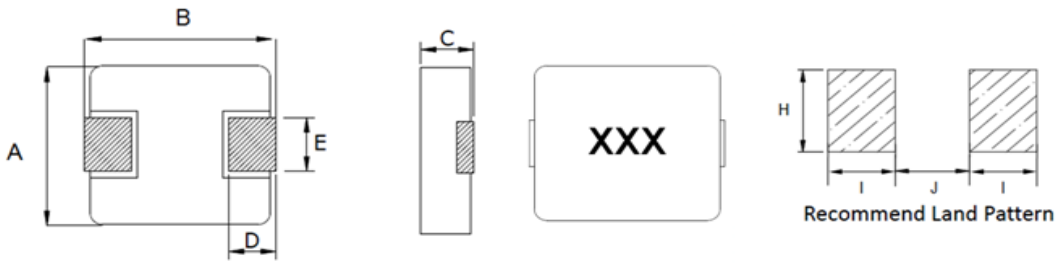

Series	A	B	C	D	E	I Typ.	J Typ.	H Typ.
MCMB-0618	6.6±0.2	7.0±0.3	1.6±0.2	1.6±0.3	3.0±0.3	2.35	3.7	3.5

## Electrical Properties:

Part Number	Inductance	DC Resistance	Saturation Current		Heat Rating Current	
	@100KHz,1V	Max.	Max.	Typ.	Max.	Typ.
Units	μH	mΩ	A		A	
Symbol	L	DCR	Isat		Irms	
MCMB-0618-R10MT	0.10±20%	2.3	30.4	38.0	23.0	25.0
MCMB-0618-R22MT	0.22±20%	3.5	19.2	24.0	20.0	22.0
MCMB-0618-R47MT	0.47±20%	8.4	14.4	18.0	10.0	11.5
MCMB-0618-R68MT	0.68±20%	12	13.2	16.5	8.40	9.50
MCMB-0618-1R0MT	1.0±20%	16	9.60	12.0	7.60	8.50
MCMB-0618-1R5MT	1.5±20%	26	7.36	9.20	7.10	8.00
MCMB-0618-2R2MT	2.2±20%	35	6.40	8.00	6.20	7.00
MCMB-0618-3R3MT	3.3±20%	50	4.80	6.00	3.80	4.50
MCMB-0618-4R7MT	4.7±20%	62	4.00	5.00	3.50	4.00
MCMB-0618-6R8MT	6.8±20%	110	3.60	4.50	2.40	3.00
MCMB-0618-8R2MT	8.2±20%	135	2.90	3.60	2.10	2.40
MCMB-0618-100MT	10±20%	155	3.20	4.00	1.95	2.30
MCMB-0618-220MT	22±20%	350	1.84	2.30	1.40	1.80

## Notes

- ※1: All test data is referenced to 20°C ambient;
- ※2: Rated current: Isat or Irms, whichever is smaller;
- ※3: Isat(Typ): DC current at which the inductance drops approximate 30% from its value without current;
- ※4: Isat(Max): DC current at which the inductance drops approximate 20% from its value without current;
- ※5: Irms(Typ): DC current that causes the temperature rise ( $\Delta T = 40^\circ\text{C}$ ) from 20°C ambient.
- ※6: Irms(Max): DC current that causes the temperature rise ( $\Delta T = 20^\circ\text{C}$ ) from 20°C ambient.
- ※7: Absolute maximum voltage 30VDC

## TYPICAL ELECTRICAL CHARACTERISTICS

**MCMB-0618-R10MT**

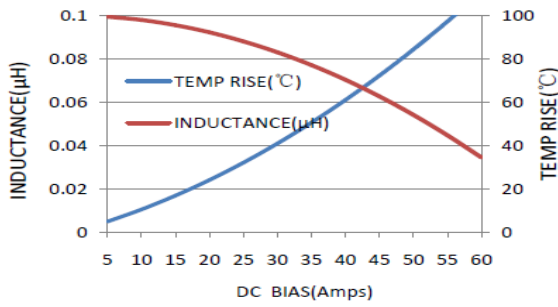

**MCMB-0618-R22MT**

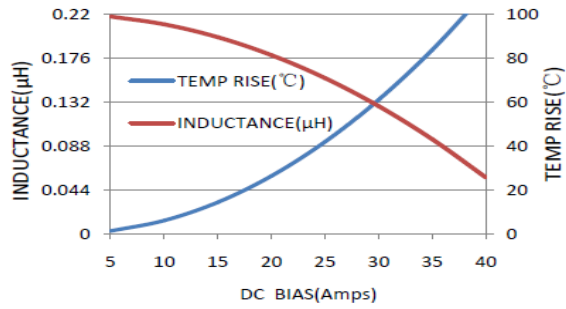

**MCMB-0618-R47MT**

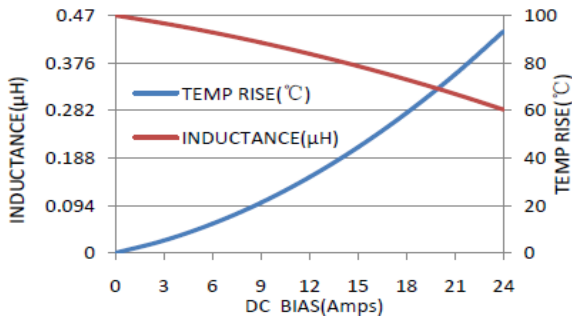

**MCMB-0618-R68MT**

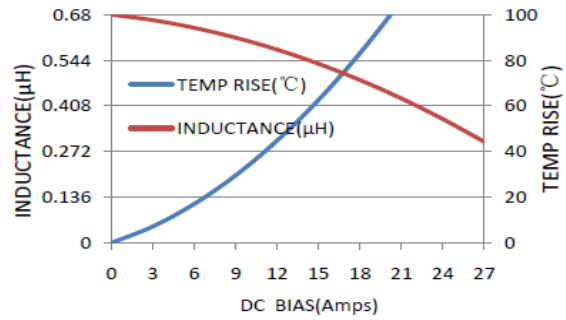

**MCMB-0618-1R0MT**

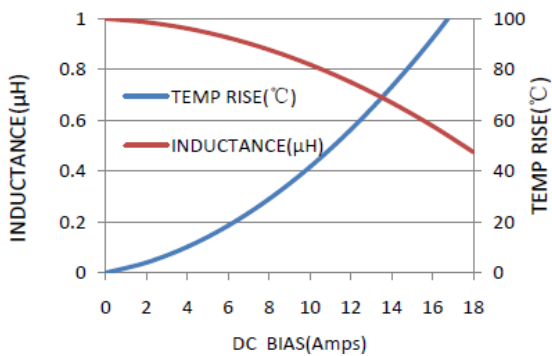

**MCMB-0618-1R5MT**

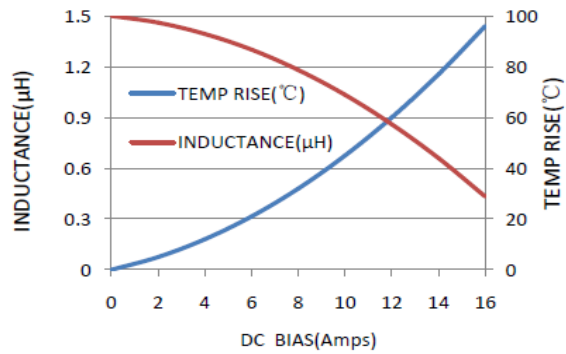

**MCMB-0618-2R2MT**

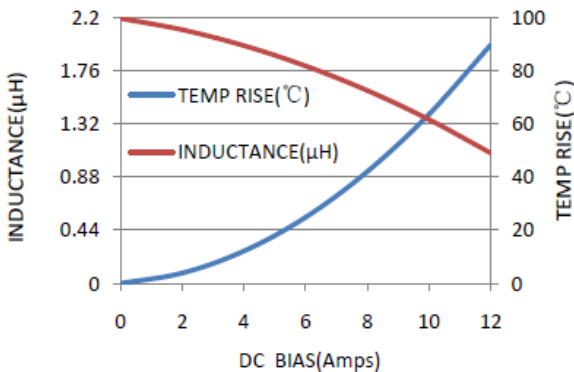

**MCMB-0618-3R3MT**

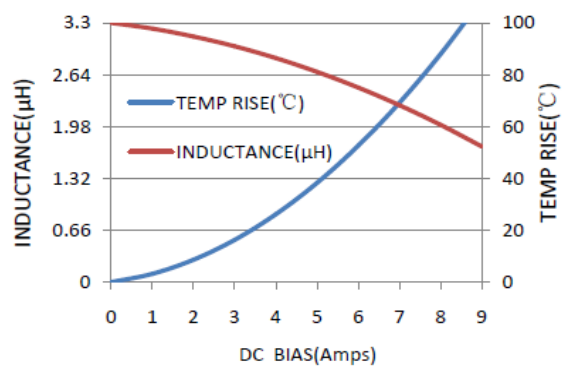

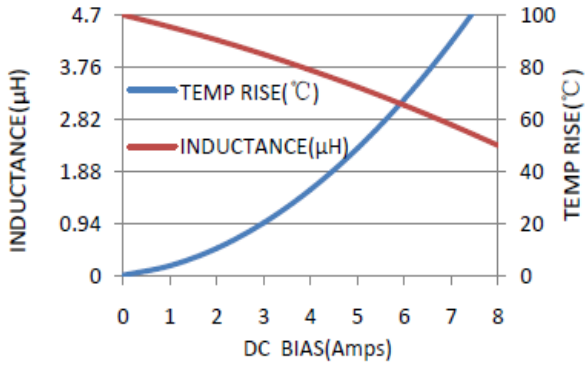
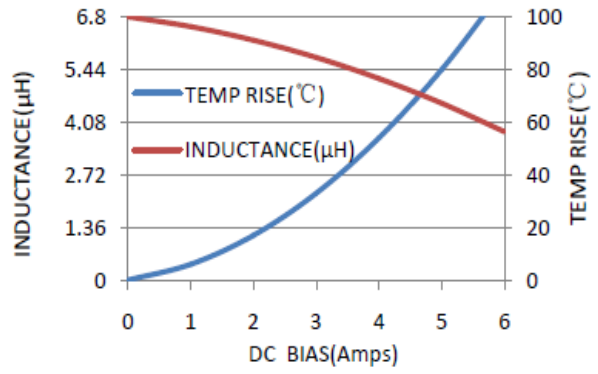
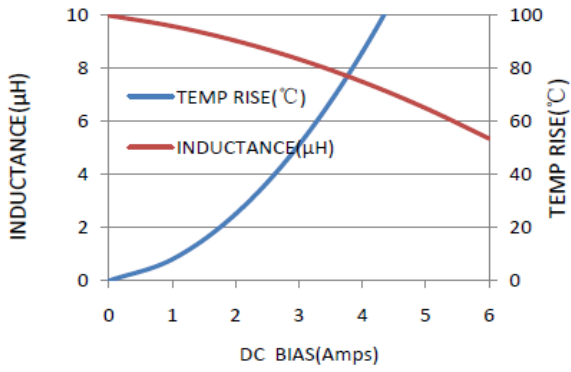
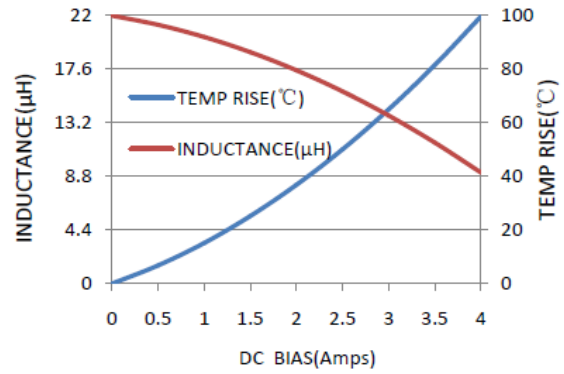
**MCMB-0618-4R7MT**

**MCMB-0618-6R8MT**

**MCMB-0618-100MT**

**MCMB-0618-220MT**

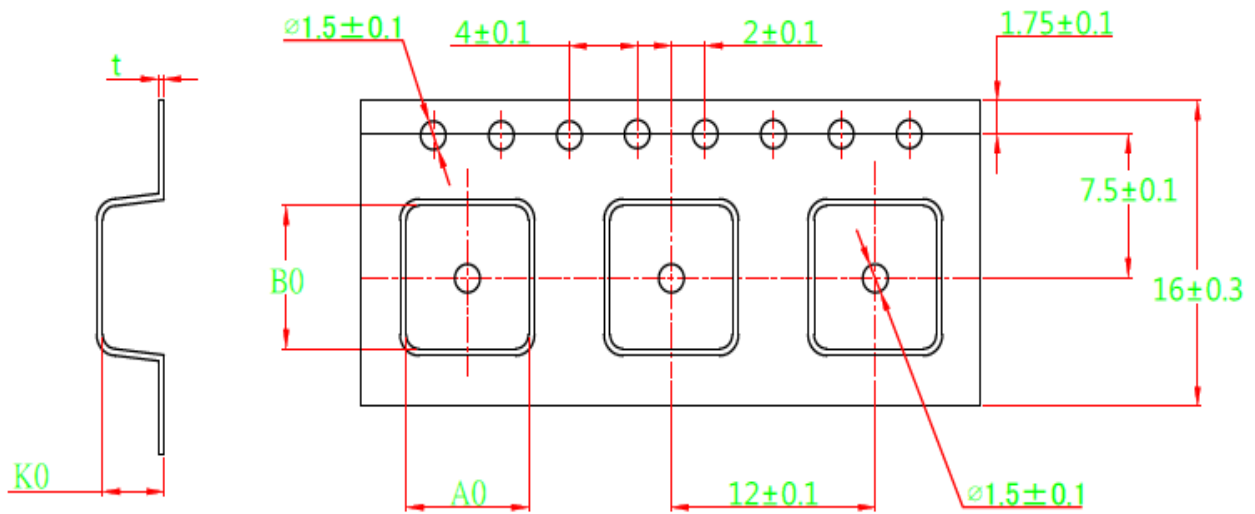
## Reliability and Test Condition

Mechanical Reliability		
Item	Specification and Requirement	Test Method
Solderability	The surface of terminal immersed shall be minimum of 95% covered with a new coating of solder	Solder heat proof: 1. Preheating: $160 \pm 10$ °C 2. Retention time: $245 \pm 5$ °C for $2 \pm 0.5$ seconds
Vibration	Inductance change: Within $\pm 10\%$ Without mechanical damage such as break	1. Vibration frequency: (10 Hz to 55 Hz to 10Hz) in 60 seconds as a period 2. Vibration time: Period cycled for 2 hours in each of 3 mutual perpendicular directions. 3. Amplitude: 1.5 mm max.
Shock	Inductance change: Within $\pm 10\%$ Without mechanical damage such as break	1. Peak value: 100 G 2. Duration of pulse: 11ms 3. 3 times in each positive and negative direction of 3 mutual perpendicular directions
Endurance Reliability		
Item	Specification and Requirement	Test Method
Thermal Shock	Inductance change: Within $\pm 10\%$ Without distinct damage in appearance	1. Repeat 100 cycles as follow: ( $-55 \pm 2$ °C; $30 \pm 3$ min) → (Room temp., 5 min) → ( $+125 \pm 2$ °C, $30 \pm 3$ min) → (Room temp., 5 min) 2. Recovery: $48 + 4 / -0$ hours of recovery under the standard condition after the test.
High Temperature Resistance	Inductance change: Within $\pm 10\%$ Without distinct damage in appearance	1. Environment condition: $85 \pm 2$ °C Applied Current: Rated current 2. Duration: $1000 + 4 / -0$ hours
Humidity Resistance	Inductance change: Within $\pm 10\%$ Without distinct damage in appearance	1. Environment condition: $60 \pm 2$ °C Humidity: 90–95% Applied Current: Rated current 2. Duration: $1000 + 4 / -0$ hours
Low Temperature Store	Inductance change: Within $\pm 10\%$ Without distinct damage in appearance	Store temperature: $-55 \pm 2$ °C, $1000 + 4 / -0$ hours
High Temperature Store	Inductance change: Within $\pm 10\%$ Without distinct damage in appearance	Store temperature: $+125 \pm 2$ °C, $1000 + 4 / -0$ hours

## Tape Packaging Dimensions



A0	B0	K0	t
7.2±0.10	7.5±0.10	2.3±0.15	0.31±0.05

## Reel Dimensions

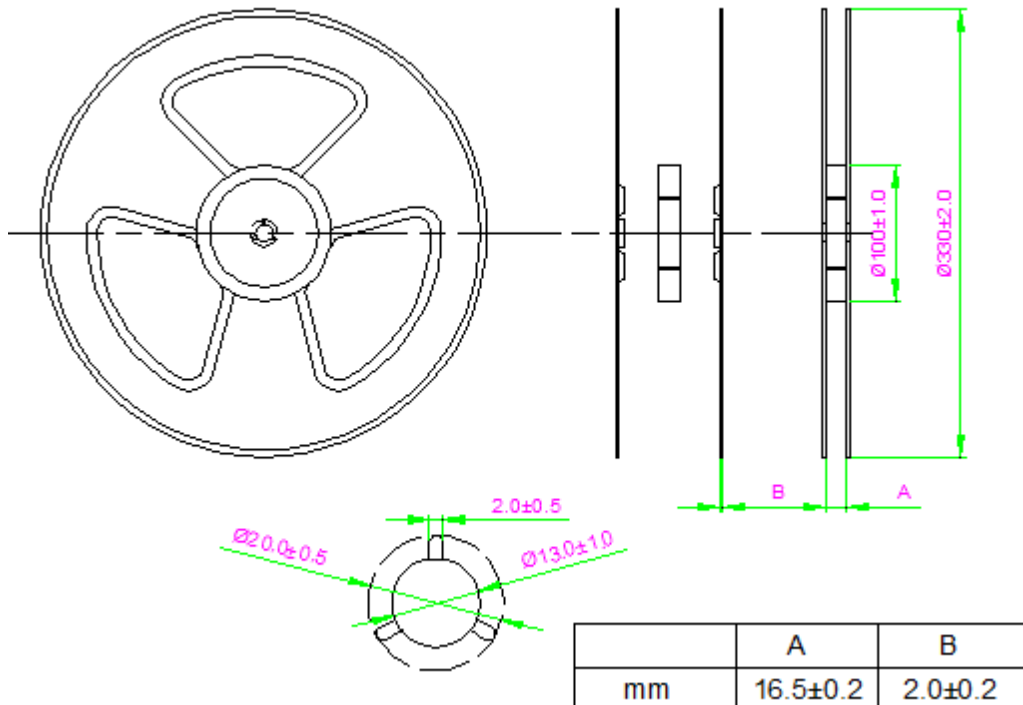

	A	B
mm	16.5±0.2	2.0±0.2

Packing Quantity: 1500pcs/Reel

## Recommended Soldering Technologies

### (1) Re-flowing Profile

Preheat condition: 150 ~200°C/60~180sec.

Allowed time above 217°C: 80~120sec.

Max temp: 260°C

Max time at max temp: 10 sec.

Solder paste: Sn/3.0Ag/0.5Cu

Allowed Reflow time: 2x max

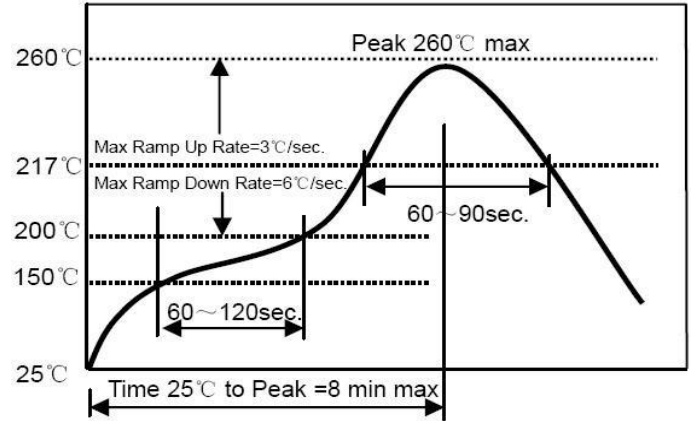

### (2) Iron Soldering Profile

Iron soldering power: Max.

30W Pre-heating: 150°C/60sec.

Soldering time: 3sec. Max.

Solder paste: Sn/3.0Ag/0.5Cu

Max.1 times for iron soldering

