

50 V, 130 kHz, 32.5  $\mu$ A per Channel, Robust, Over-The-Top, Precision Op Amps

**FEATURES**

- ▶ Ultrawide common-mode input range:  $-V_S - 0.1$  V to  $-V_S + 70$  V
- ▶ Wide power supply voltage range: +3 V to +50 V (to  $\pm 25$  V for PSRR)
- ▶ Low power supply current: 32.5  $\mu$ A (typical)
- ▶ Low input offset voltage:  $\pm 60$   $\mu$ V maximum
- ▶ Low input offset voltage drift:  $\pm 1$   $\mu$ V/ $^{\circ}$ C maximum (B grade)
- ▶ Low input voltage noise
  - ▶ 6 Hz typical 1/f noise corner
- ▶ 1000 nV p-p typical at 0.1 Hz to 10 Hz
- ▶ GBP: 130 kHz typical for  $f_{TEST} = 250$  Hz
- ▶ Slew rate: 0.1 V/ $\mu$ s typical at  $\Delta V_{OUT} = 4$  V
- ▶ Low power supply current shutdown: 20  $\mu$ A maximum
- ▶ Low input offset current:  $\pm 300$  pA maximum
- ▶ Large signal voltage gain: 120 dB minimum for  $\Delta V_{OUT} = 3.5$  V
- ▶ CMRR: 120 dB minimum at  $V_{CM} = -0.1$  V to +70 V
- ▶ PSRR: 123 dB minimum at  $V_{SY} = +3$  V to  $\pm 25$  V
- ▶ Input overdrive tolerant with no phase reversal
- ▶  $\pm 2$  kV HBM and  $\pm 1.25$  kV FICDM
- ▶ Wide temperature range:  $-55^{\circ}$ C to  $+150^{\circ}$ C (H grade)
- ▶ Shutdown feature available for single 6-lead TSOT and dual 10-lead LFCSP packages

**APPLICATIONS**

- ▶ Industrial sensor conditioning
- ▶ Supply current sensing

**TYPICAL APPLICATION CIRCUIT**

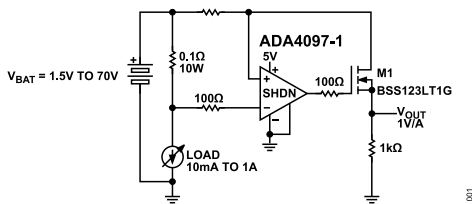

Figure 1.1 V/A Over-The-Top Current Sense Application ( $V_{BAT}$  Is the Battery Voltage.)

- ▶ Battery and power supply monitoring
- ▶ Front-end amplifiers in abusive environments
- ▶ 4 mA to 20 mA transmitters

**GENERAL DESCRIPTION**

The ADA4097-1/ADA4097-2 are single and dual robust, precision, rail-to-rail input and output operational amplifiers (op amps) with inputs that operate from  $-V_S$  to  $+V_S$  and beyond, which are referred to in this data sheet as Over-The-Top™. The devices feature offset voltages of  $< 60$   $\mu$ V, input bias currents ( $I_B$ ) of  $< 0.3$  nA, and can operate on single or split supplies that range from 3 V to 50 V. The ADA4097-1/ADA4097-2 draw 32.5  $\mu$ A of supply current per channel.

The ADA4097-1/ADA4097-2 Over-The-Top™ input stages have robust input protection features for abusive environments. The inputs can tolerate up to 80 V of differential voltage without damage or degradation to dc accuracy. The operating common-mode input range extends from rail-to-rail and beyond, up to 70 V  $> -V_S$ , independent of the  $+V_S$  supply.

The ADA4097-1/ADA4097-2 are unity-gain stable and can drive loads requiring up to 20 mA per channel. The devices can also drive capacitive loads as large as 200 pF. The amplifiers are available with low power shutdown.

The ADA4097-1 is available in a standard, 6-lead thin small outline transistor (TSOT) package. The ADA4097-2 is available in an 8-lead standard small outline (SOIC\_N) package, 8-lead mini small outline package (MSOP), and 10-lead lead-frame chip-scale package (LFCSP).

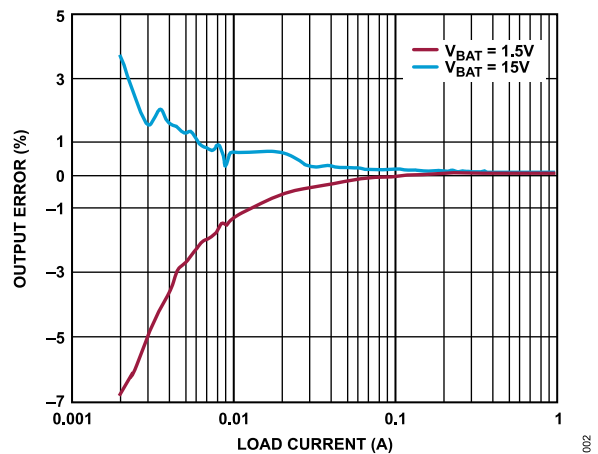

Figure 2. Output Error vs. Load Current

**TABLE OF CONTENTS**

Features.....	1	Output.....	22
Applications.....	1	Shutdown Pins (SHDN and SHDNx) .....	22
General Description.....	1	Applications Information.....	23
Typical Application Circuit.....	1	Large Resistor Gain Operation.....	23
Specifications.....	3	Recommended Values for Various Gains.....	23
5 V Supply.....	3	Noise.....	24
±15 V Supply.....	5	Distortion.....	24
Absolute Maximum Ratings.....	8	Power Dissipation and Thermal Shutdown.....	25
Maximum Power Dissipation.....	8	Circuit Layout Considerations.....	25
Thermal Resistance.....	8	Power Supply Bypassing.....	25
Electrostatic Discharge (ESD) Ratings.....	8	Grounding.....	25
ESD Caution.....	9	ESD Protection when Powered.....	26
Pin Configurations and Function Descriptions.....	10	Related Products.....	26
Typical Performance Characteristics.....	12	Typical Applications.....	27
Theory of Operation.....	20	Outline Dimensions.....	29
Input Protection.....	21	Ordering Guide.....	31
Over-The-Top Operation Considerations.....	21	Evaluation Boards.....	31

**REVISION HISTORY****4/2022—Rev. 0 to Rev. A**

Added ADA4097-2, 8-Lead SOIC_N, 8-Lead MSOP, and 10-Lead LFCSP.....	1
Changes to Data Sheet Title.....	1
Changes to Features.....	1
Changes to General Description Section.....	1
Changes to 5 V Supply Section and Table 1.....	3
Changes to ±15 V Supply Section and Table 2.....	5
Changes to Table 3.....	8
Changes to Maximum Power Dissipation Section.....	8
Changes to Thermal Resistance Section and Table 4.....	8
Changes to Table 5 and Table 5 Title.....	9
Changes to Figure 4 Caption and Table 6 Title.....	10
Added Figure 5, Table 7, Figure 6, and Table 8; Renumbered Sequentially.....	10
Changes to Figure 56.....	21
Changes to Output Section.....	22
Changes to Shutdown Pins (SHDN and SHDNx) Section.....	22
Changes to Power Dissipation and Thermal Shutdown Section.....	25
Changes to Power Supply Bypassing Section.....	25
Changes to Table 10.....	26
Added Figure 75, Figure 76, and Figure 77.....	29
Added Evaluation Boards Section.....	31

**5/2021—Revision 0: Initial Version**

## SPECIFICATIONS

## 5 V SUPPLY

Common-mode voltage ( $V_{CM}$ ) = 2.5 V, SHDN pin (ADA4097-1) and SHDNx pins (ADA4097-2 the 10-lead LFCSP only) are open, load resistance ( $R_{LOAD}$ ) = 499 k $\Omega$  to midsupply, and  $T_A$  = 25°C, unless otherwise noted.

Table 1.

Parameter	Test Conditions/Comments	B Grade			H Grade			Unit	
		Min	Typ	Max	Min	Typ	Max		
<b>DC PERFORMANCE</b>									
Input Offset Voltage ( $V_{OS}$ ) <sup>1</sup>	0.25 V < $V_{CM}$ < 3.25 V		±20	±60		±20	±60	$\mu$ V	
	Minimum temperature ( $T_{MIN}$ ) < $T_A$ < maximum temperature ( $T_{MAX}$ )			±130			±160	$\mu$ V	
	0.25 V < $V_{CM}$ < 70 V		±30	±60		±30	±60	$\mu$ V	
	$T_{MIN}$ < $T_A$ < $T_{MAX}$			±160			±185	$\mu$ V	
	-0.1 V < $V_{CM}$ < +70 V		±30	±60		±30	±60	$\mu$ V	
	$T_{MIN}$ < $T_A$ < $T_{MAX}$			±550			±600	$\mu$ V	
Input Offset Voltage Drift <sup>2</sup>	$T_{MIN}$ < $T_A$ < $T_{MAX}$		±0.1	±1		±0.1	±1.5	$\mu$ V/°C	
Input Bias Current ( $I_B$ )			±0.1	±0.3		±0.1	±0.3	nA	
	$T_{MIN}$ < $T_A$ < $T_{MAX}$			±10			±25	nA	
	$V_{CM}$ = 70 V, Over-The-Top	0.25	0.8	1.5	0.25	0.8	1.5	$\mu$ A	
	$T_{MIN}$ < $T_A$ < $T_{MAX}$	0.175		2.25	0.125		2.5	$\mu$ A	
	0 V < $V_{CM}$ < 70 V, $V_{SY}$ = 0 V		0.001	1		0.001	1	$\mu$ A	
	$T_{MIN}$ < $T_A$ < $T_{MAX}$			10			10	$\mu$ A	
Input Offset Current ( $I_{OS}$ )			±100	±300		±100	±300	pA	
	$T_{MIN}$ < $T_A$ < $T_{MAX}$			±5			±10	nA	
	$V_{CM}$ = 70 V, Over-The-Top <sup>3</sup>		±0.025	±0.065		±0.025	±0.065	$\mu$ A	
	$T_{MIN}$ < $T_A$ < $T_{MAX}$			±0.095			±0.2	$\mu$ A	
	Common-Mode Rejection Ratio (CMRR)	$V_{CM}$ = -0.1 V to +70 V	120	145		120	145		dB
		$T_{MIN}$ < $T_A$ < $T_{MAX}$	101			100			dB
$V_{CM}$ = 0.25 V to 3.25 V		115	134		115	134		dB	
$T_{MIN}$ < $T_A$ < $T_{MAX}$		110			107			dB	
Common-Mode Input Range	Guaranteed by CMRR tests	-0.1		+70	-0.1		+70	V	
Large Signal Voltage Gain ( $A_{OL}$ )	Delta output voltage ( $\Delta V_{OUT}$ ) = 3.5 V	120	140		120	140		dB	
	$T_{MIN}$ < $T_A$ < $T_{MAX}$	114			112			dB	
	$\Delta V_{OUT}$ = 3.5 V, $R_{LOAD}$ = 10 k $\Omega$	96	108		96	108		dB	
	$T_{MIN}$ < $T_A$ < $T_{MAX}$	90			86			dB	
<b>NOISE PERFORMANCE</b>									
Input Voltage Noise	Frequency (f) = 0.1 Hz to 10 Hz		1000			1000		nV p-p	
	1/f noise corner		6			6		Hz	
	f = 100 Hz		53			53		nV/ $\sqrt$ Hz	
	Over-The-Top	f = 100 Hz, $V_{CM}$ > 5 V		65			65	nV/ $\sqrt$ Hz	
Input Current Noise	f = 100 Hz		0.05			0.05		pA/ $\sqrt$ Hz	
	Over-The-Top	f = 100 Hz, $V_{CM}$ > 5 V		0.5		0.5		pA/ $\sqrt$ Hz	
<b>DYNAMIC PERFORMANCE</b>									
Slew Rate	$\Delta V_{OUT}$ = 4 V	0.025	0.1		0.025	0.1		V/ $\mu$ s	
	$T_{MIN}$ < $T_A$ < $T_{MAX}$	0.018			0.015			V/ $\mu$ s	
Gain Bandwidth Product (GBP)	Test frequency ( $f_{TEST}$ ) = 250 Hz	120	130		120	130		kHz	
	$T_{MIN}$ < $T_A$ < $T_{MAX}$	100			100			kHz	
Phase Margin			58			58		Degrees	

## SPECIFICATIONS

Table 1.

Parameter	Test Conditions/Comments	B Grade			H Grade			Unit
		Min	Typ	Max	Min	Typ	Max	
1% Settling Time	$\Delta V_{OUT} = \pm 2 \text{ V}$		70			70		$\mu\text{s}$
0.1% Settling Time	$\Delta V_{OUT} = \pm 2 \text{ V}$		100			100		$\mu\text{s}$
Total Harmonic Distortion Plus Noise (THD + N)	$f = 1 \text{ kHz}$ , $V_{OUT} = 2 \text{ V p-p}$ , $R_{LOAD} = 10 \text{ k}\Omega$ , bandwidth = 80 kHz		0.05			0.05		%
Channel Separation	$f = 1 \text{ kHz}$ , $R_{LOAD} = 2 \text{ k}\Omega$		115			115		dB
INPUT CHARACTERISTICS								
Input Resistance	Differential mode		10			10		M $\Omega$
	Common mode		>1			>1		G $\Omega$
Over-The-Top	Differential mode, $V_{CM} > 5 \text{ V}$		60			60		k $\Omega$
	Common mode, $V_{CM} > 5 \text{ V}$		>1			>1		G $\Omega$
Input Capacitance	Differential mode		1			1		pF
	Common mode		3			3		pF
SHDN AND SHDNx PINS								
Input Logic Low	Amplifier active, SHDN and SHDNx pin voltage ( $V_{SHDN}$ ) < $-V_S + 0.5 \text{ V}$ , $T_{MIN} < T_A < T_{MAX}$			$-V_S + 0.5$			$-V_S + 0.5$	V
Input Logic High	Amplifier shutdown, $V_{SHDN} > -V_S + 1.5 \text{ V}$ , $T_{MIN} < T_A < T_{MAX}$	$-V_S + 1.5$			$-V_S + 1.5$			V
Response Time	Amplifier active to shutdown		2.5			2.5		$\mu\text{s}$
	Amplifier shutdown to active		100			100		$\mu\text{s}$
Pull-Down Current	$V_{SHDN} = -V_S + 0.5 \text{ V}$ , $T_{MIN} < T_A < T_{MAX}$		0.6	3		0.6	3	$\mu\text{A}$
	$V_{SHDN} = -V_S + 1.5 \text{ V}$ , $T_{MIN} < T_A < T_{MAX}$		0.3	2.5		0.3	2.5	$\mu\text{A}$
OUTPUT CHARACTERISTICS								
Output Voltage Swing Low	Overdrive voltage ( $V_{OD}^4$ ) = 30 mV, no load		15	40		15	40	mV
	$T_{MIN} < T_A < T_{MAX}$			45			50	mV
	$V_{OD} = 30 \text{ mV}$ , sink current ( $I_{SINK}$ ) = 5 mA		240	325		240	325	mV
Output Voltage Swing High	$T_{MIN} < T_A < T_{MAX}$			380			400	mV
	$V_{OD} = 30 \text{ mV}$ , no load		2.5	5		2.5	5	mV
	$T_{MIN} < T_A < T_{MAX}$			10			15	mV
Short-Circuit Current	$V_{OD} = 30 \text{ mV}$ , source current ( $I_{SOURCE}$ ) = 5 mA		570	700		570	700	mV
	$T_{MIN} < T_A < T_{MAX}$			1000			1100	mV
	$I_{SOURCE}$	20	30		20	30		mA
Output Pin Leakage During Shutdown	$T_{MIN} < T_A < T_{MAX}$	10			6			mA
	$I_{SINK}$	35	40		35	40		mA
	$T_{MIN} < T_A < T_{MAX}$	10			6			mA
Output Pin Leakage During Shutdown	$V_{SHDN} = -V_S + 1.5 \text{ V}$		$\pm 5$	$\pm 100$		$\pm 5$	$\pm 100$	nA
	$T_{MIN} < T_A < T_{MAX}$			$\pm 10$			$\pm 10$	$\mu\text{A}$
POWER SUPPLY								
Maximum Operating Voltage <sup>5</sup>				50			50	V
$V_{SY}$ Range	Guaranteed by power supply rejection ratio (PSRR)	3		50	3		50	V
Supply Current per Channel	Amplifier active		32.5	36		32.5	36	$\mu\text{A}$
	$T_{MIN} < T_A < T_{MAX}$			55			60	$\mu\text{A}$

## SPECIFICATIONS

Table 1.

Parameter	Test Conditions/Comments	B Grade			H Grade			Unit
		Min	Typ	Max	Min	Typ	Max	
PSRR	Amplifier shutdown, $V_{SHDN} = -V_S + 1.5\text{ V}$		12	20		12	20	$\mu\text{A}$
	$T_{MIN} < T_A < T_{MAX}$			22.5			22.5	$\mu\text{A}$
	$V_{SY} = +3\text{ V to } \pm 25\text{ V}$	123	145		123	145		dB
	$T_{MIN} < T_A < T_{MAX}$	120			120			dB
THERMAL SHUTDOWN <sup>6</sup>								
Temperature	$T_J$		175			175		$^{\circ}\text{C}$
Hysteresis			20			20		$^{\circ}\text{C}$
Operating Temperature	$T_A$	-40		+125	-55		+150	$^{\circ}\text{C}$

<sup>1</sup> Thermoelectric voltages present in the high speed production test limit the measurement accuracy of this parameter. The limits shown in Table 1 are determined by test capability and are not necessarily indicative of actual device performance.

<sup>2</sup> Offset voltage drift is guaranteed through lab characterization and is not production tested.

<sup>3</sup> Test accuracy is limited by high speed production test equipment repeatability. Bench measurements indicate that the input offset current in Over-The-Top configuration is typically controlled to under 50 nA at +25 $^{\circ}\text{C}$  and 100 nA over the -55 $^{\circ}\text{C} < T_A < +150^{\circ}\text{C}$  temperature range.

<sup>4</sup>  $V_{OD}$  is +30 mV for  $V_{OUT}$  high and -30 mV for  $V_{OUT}$  low.

<sup>5</sup> Maximum operating voltage is limited by the time-dependent dielectric breakdown (TDDb) of the on-chip capacitor oxides. The amplifier tolerates temporary transient overshoot up to the specified absolute maximum rating, but the dc supply voltage must be limited to the maximum operating voltage.

<sup>6</sup> Thermal shutdown is lab characterized only and is not tested in production.

 **$\pm 15\text{ V SUPPLY}$** 

$V_{CM} = 0\text{ V}$ , SHDN pin (ADA4097-1) and SHDNx pins (ADA4097-2 for the 10-lead LFCSP only) are open,  $R_{LOAD} = 499\text{ k}\Omega$  to ground, and  $T_A = 25^{\circ}\text{C}$ , unless otherwise noted.

Table 2.

Parameter	Test Conditions/Comments	B Grade			H Grade			Unit
		Min	Typ	Max	Min	Typ	Max	
DC PERFORMANCE								
$V_{OS}^1$			$\pm 20$	$\pm 60$		$\pm 20$	$\pm 60$	$\mu\text{V}$
	$T_{MIN} < T_A < T_{MAX}$			$\pm 150$			$\pm 175$	$\mu\text{V}$
	$V_{SY} = \pm 25\text{ V}$		$\pm 20$	$\pm 60$		$\pm 20$	$\pm 60$	$\mu\text{V}$
Input Offset Voltage Drift <sup>2</sup>	$T_{MIN} < T_A < T_{MAX}$			$\pm 150$			$\pm 175$	$\mu\text{V}$
	$T_{MIN} < T_A < T_{MAX}$		$\pm 0.1$	$\pm 1$		$\pm 0.1$	$\pm 1.5$	$\mu\text{V}/^{\circ}\text{C}$
Input Bias Current ( $I_B$ )			$\pm 0.1$	$\pm 0.3$		$\pm 0.1$	$\pm 0.3$	nA
	$T_{MIN} < T_A < T_{MAX}$			$\pm 10$			$\pm 25$	nA
	$V_{SY} = \pm 25\text{ V}$		$\pm 0.1$	$\pm 0.3$		$\pm 0.1$	$\pm 0.3$	nA
$I_{OS}$	$T_{MIN} < T_A < T_{MAX}$			$\pm 10$			$\pm 25$	nA
			$\pm 0.1$	$\pm 0.3$		$\pm 0.1$	$\pm 0.3$	nA
	$T_{MIN} < T_A < T_{MAX}$			$\pm 5$			$\pm 10$	nA
CMRR	$V_{CM} = -14.75\text{ V to } +13.25\text{ V}$	117	135		117	135		dB
	$T_{MIN} < T_A < T_{MAX}$	109			109			dB
	$V_{CM} = -15.1\text{ V to } +13.25\text{ V}$	117	135		117	135		dB
	$T_{MIN} < T_A < T_{MAX}$	93			92			dB
	$V_{CM} = -15.1\text{ V to } +55\text{ V}$	117	140		117	140		dB
	$T_{MIN} < T_A < T_{MAX}$	101			100			dB

## SPECIFICATIONS

Table 2.

Parameter	Test Conditions/Comments	B Grade			H Grade			Unit
		Min	Typ	Max	Min	Typ	Max	
Common-Mode Input Range $A_{OL}$	Guaranteed by CMRR tests	-15.1		+55	-15.1		+55	V
	$\Delta V_{OUT} = 25$ V	120	150		120	150		dB
	$T_{MIN} < T_A < T_{MAX}$	114			112			dB
	$\Delta V_{OUT} = 25$ V, $R_{LOAD} = 10$ k $\Omega$	100	108		100	108		dB
	$T_{MIN} < T_A < T_{MAX}$	94			90			dB
NOISE PERFORMANCE								
Input Voltage Noise	$f = 0.1$ Hz to 10 Hz		1000			1000		nV p-p
	1/f noise corner		6			6		Hz
	$f = 100$ Hz		53			53		nV/ $\sqrt{\text{Hz}}$
	Over-The-Top	$f = 100$ Hz, $V_{CM} > +V_S$		65			65	
Input Current Noise	$f = 100$ Hz		0.05			0.05		pA/ $\sqrt{\text{Hz}}$
	Over-The-Top	$f = 100$ Hz, $V_{CM} > +V_S$		0.5		0.5		pA/ $\sqrt{\text{Hz}}$
DYNAMIC PERFORMANCE								
Slew Rate	$\Delta V_{OUT} = 25$ V	0.03	0.1		0.03	0.1		V/ $\mu\text{s}$
	$T_{MIN} < T_A < T_{MAX}$	0.02			0.015			V/ $\mu\text{s}$
GBP	$f_{TEST} = 250$ Hz	125	130		125	130		kHz
	$T_{MIN} < T_A < T_{MAX}$	100			100			kHz
Phase Margin			59			59		Degrees
1% Settling Time	$\Delta V_{OUT} = \pm 2$ V		70			70		$\mu\text{s}$
0.1% Settling Time	$\Delta V_{OUT} = \pm 2$ V		100			100		$\mu\text{s}$
THD + N	$f = 1$ kHz, $V_{OUT} = 5.6$ V p-p, $R_{LOAD} = 10$ k $\Omega$ , bandwidth = 80 kHz		0.1			0.1		%
Channel Separation	$f = 1$ kHz, $R_{LOAD} = 2$ k $\Omega$		115			115		dB
INPUT CHARACTERISTICS								
Input Resistance	Differential mode		10			10		M $\Omega$
	Common mode		>1			>1		G $\Omega$
Input Capacitance	Differential mode		1			1		pF
	Common mode		3			3		pF
SHDN AND SHDNx PINS								
Input Logic Low	Amplifier active, $V_{SHDN} < -V_S + 0.5$ V			$-V_S + 0.5$			$-V_S + 0.5$	V
Input Logic High	Amplifier shutdown, $V_{SHDN} > -V_S + 1.5$ V	$-V_S + 1.5$			$-V_S + 1.5$			V
Response Time	Amplifier active to shutdown		2.5			2.5		$\mu\text{s}$
	Amplifier shutdown to active		100			100		$\mu\text{s}$
Pull-Down Current	$V_{SHDN} = -V_S + 0.5$ V, $T_{MIN} < T_A < T_{MAX}$		0.3	3		0.3	3	$\mu\text{A}$
	$V_{SHDN} = -V_S + 1.5$ V, $T_{MIN} < T_A < T_{MAX}$		0.6	2.5		0.6	2.5	$\mu\text{A}$
OUTPUT CHARACTERISTICS								
Output Voltage Swing Low	$V_{OD}^3 = 30$ mV, no load		15	40		15	40	mV
	$T_{MIN} < T_A < T_{MAX}$			45			50	mV
	$V_{OD} = 30$ mV, $I_{SINK} = 5$ mA		240	325		240	325	mV
	$T_{MIN} < T_A < T_{MAX}$			380			400	mV
Output Voltage Swing High	$V_{OD} = 30$ mV, no load		2.5	10		2.5	10	mV
	$T_{MIN} < T_A < T_{MAX}$			15			20	mV
	$V_{OD} = 30$ mV, $I_{SOURCE} = 5$ mA		570	700		570	700	mV
	$T_{MIN} < T_A < T_{MAX}$			1000			1100	mV

## SPECIFICATIONS

Table 2.

Parameter	Test Conditions/Comments	B Grade			H Grade			Unit
		Min	Typ	Max	Min	Typ	Max	
Short-Circuit Current	$I_{SOURCE}$	20	30		20	30		mA
	$T_{MIN} < T_A < T_{MAX}$	10			6			mA
	$I_{SINK}$	35	45		35	45		mA
	$T_{MIN} < T_A < T_{MAX}$	10			6			mA
POWER SUPPLY								
Maximum Operating Voltage <sup>4</sup>				50			50	V
$V_{SY}$ Range	Guaranteed by PSRR	3		50	3		50	V
Supply Current per Channel	Amplifier active		40	44		40	44	$\mu$ A
	$T_{MIN} < T_A < T_{MAX}$			65			70	$\mu$ A
	$V_{SY} = \pm 25$ V		42	48		42	48	$\mu$ A
	$T_{MIN} < T_A < T_{MAX}$			70			75	$\mu$ A
	Amplifier shutdown, $V_{SHDN} = -V_S + 1.5$ V		15	22.5		15	22.5	$\mu$ A
	$T_{MIN} < T_A < T_{MAX}$			25			25	$\mu$ A
PSRR	$V_{SY} = 3$ V to 50 V	123	145		123	145		dB
	$T_{MIN} < T_A < T_{MAX}$	120			120			dB
THERMAL SHUTDOWN <sup>5</sup>								
Temperature	$T_J$		175			175		$^{\circ}$ C
Hysteresis			20			20		$^{\circ}$ C
Operating Temperature	$T_A$	-40		+125	-55		+150	$^{\circ}$ C

<sup>1</sup> Thermoelectric voltages present in the high speed production test limit the measurement accuracy of this parameter. The limits shown in Table 2 are determined by test capability and are not necessarily indicative of actual device performance.

<sup>2</sup> Offset voltage drift is guaranteed through lab characterization and is not production tested.

<sup>3</sup>  $V_{OD}$  is +30 mV for  $V_{OUT}$  high and -30 mV for  $V_{OUT}$  low.

<sup>4</sup> Maximum operating voltage is limited by the TDDB of the on-chip capacitor oxides. The amplifier tolerates temporary transient overshoot up to the specified absolute maximum rating and the dc supply voltage must be limited to the maximum operating voltage.

<sup>5</sup> Thermal shutdown is lab characterized only and is not tested in production.

## ABSOLUTE MAXIMUM RATINGS

**Table 3.**

Parameter	Rating
Supply Voltage <sup>1</sup>	
Transient	60 V
Continuous	50 V
Power Dissipation ( $P_D$ )	See Figure 3
Differential Input Voltage	$\pm 80$ V
$\pm$ IN and $\pm$ INx Pin Voltage <sup>2</sup>	
Continuous	-10 V to +80 V
Survival	-15 V to +80 V
$\pm$ IN and $\pm$ INx Pin Current <sup>2</sup>	10 mA
SHDN and SHDNx Pin Voltage <sup>3</sup>	-0.3 V to +60 V
Storage Temperature Range	-65°C to +150°C
Operating Temperature Range	-55°C to +150°C
Lead Temperature (Soldering, 10 sec)	300°C
$T_J$	175°C

<sup>1</sup> Maximum supply voltage is limited by the TDDB of the on-chip capacitor oxides. The amplifiers tolerate temporary transient overshoot up to the specified transient maximum rating. The continuous operating supply voltage must be limited to no more than 50 V.

<sup>2</sup>  $\pm$ IN refers to the +IN and -IN pins on the ADA4097-1, and  $\pm$ INx refers to the +IN1, -IN1, +IN2, and -IN2 pins on the ADA4097-2.

<sup>3</sup> SHDN is Pin 5 on the ADA4097-1, and SHDNx refers to the SHDN1 and SHDN2 pins (Pin 5 and Pin 6, respectively) on the ADA4097-2 (10-lead LFCSP).

Stresses at or above those listed under Absolute Maximum Ratings may cause permanent damage to the device. This is a stress rating only; functional operation of the product at these or any other conditions above those indicated in the operational section of this specification is not implied. Operation beyond the maximum operating conditions for extended periods may affect product reliability.

$T_J$  exceeding 125°C promotes accelerated aging. The ADA4097-1/ADA4097-2 demonstrate  $\pm 25$  V supply operation beyond 1000 hours at  $T_A = 150^\circ\text{C}$ .

### MAXIMUM POWER DISSIPATION

The maximum safe PD on the devices is limited by the associated rise in either  $T_C$  or  $T_J$  on the die. At approximately  $T_C = 150^\circ\text{C}$ , which is the glass transition temperature, the properties of the plastic changes. Exceeding this temperature limit, even temporarily, may change the stresses that the package exerts on the die, which permanently shifts the parametric performance of the ADA4097-1/ADA4097-2. Exceeding  $T_J = 175^\circ\text{C}$  for an extended period may result in changes in the silicon devices and may potentially cause failure of the devices.

The  $P_D$  on the package is the sum of the quiescent power dissipation and the power dissipated in the package due to the output load drive. The quiescent power is expressed as  $V_{SY} \times I_{SY}$ , where  $I_{SY}$  is the quiescent current.

The  $P_D$  due to the load drive depends on the application. The  $P_D$  due to load drive is calculated by multiplying the load current by the associated voltage drop across the devices. RMS voltages and currents must be used in these calculations.

Airflow increases heat dissipation, effectively reducing  $\theta_{JA}$ . Additional metal that is directly in contact with the package leads from metal traces through vias, ground, and power planes reduces  $\theta_{JA}$ .

Figure 3 shows the maximum  $P_D$  vs.  $T_A$  for the single 6-lead TSOT package on a JEDEC standard, 4-layer board, with  $-V_S$  connected to a pad that is thermally connected to a printed circuit board (PCB) plane.  $\theta_{JA}$  values are approximations.

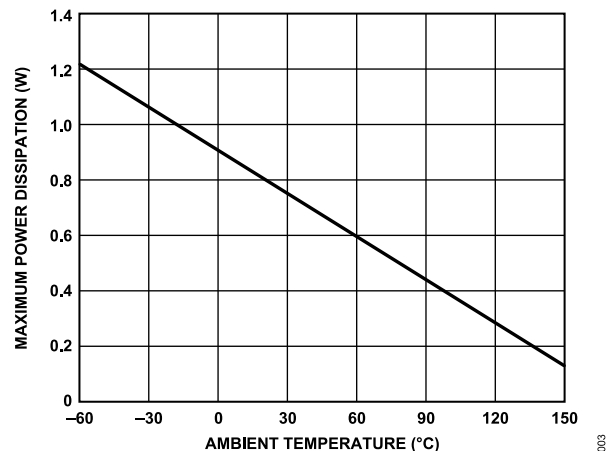

**Figure 3. Maximum Power Dissipation vs. Ambient Temperature**

### THERMAL RESISTANCE

Thermal performance is directly linked to PCB design and operating environment. Careful attention to PCB thermal design is required.

$\theta_{JA}$  is the junction to ambient thermal resistance, and  $\theta_{JC}$  is the junction-to-case thermal resistance.

**Table 4. Thermal Resistance**

Package Type	$\theta_{JA}$	$\theta_{JC}$	Unit
UJ-6	192	51	°C/W
R-8	120	38	°C/W
RM-8	163	40	°C/W
05-08-1699	43	5.5	°C/W

### ELECTROSTATIC DISCHARGE (ESD) RATINGS

The following ESD information is provided for handling of ESD-sensitive devices in an ESD protected area only.

Human body model (HBM) per ANSI/ESDA/JEDEC JS-001.

Field induced charged device model (FICDM) per ANSI/ESDA/JEDEC JS-002.



**ABSOLUTE MAXIMUM RATINGS****ESD Ratings for ADA4097-1/ADA4097-2***Table 5. ADA4097-1 6-Lead TSOT, ADA4097-2 8-Lead SOIC\_N, ADA4097-2 8-Lead MSOP, and ADA4097-2 10-Lead LFCSP*

ESD Model	Withstand Threshold (kV)	Class
HBM	±2	3A
FICDM	±1.25	3

**ESD CAUTION**

**ESD (electrostatic discharge) sensitive device.** Charged devices and circuit boards can discharge without detection. Although this product features patented or proprietary protection circuitry, damage may occur on devices subjected to high energy ESD. Therefore, proper ESD precautions should be taken to avoid performance degradation or loss of functionality.

PIN CONFIGURATIONS AND FUNCTION DESCRIPTIONS

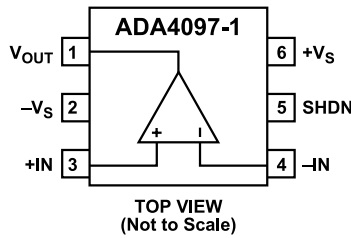

Figure 4. Pin Configuration for the ADA4097-1 6-Lead TSOT

Table 6. Pin Function Descriptions for ADA4097-1 6-Lead TSOT

Pin No.	Mnemonic	Description
1	V <sub>OUT</sub>	Amplifier Output.
2	-V <sub>S</sub>	Negative Power Supply. In single-supply applications, the -V <sub>S</sub> pin is normally soldered to a low impedance ground plane. In split-supply applications, bypass the -V <sub>S</sub> pin with a capacitance of at least 0.1 μF to a low impedance ground plane, as close to the -V <sub>S</sub> pin as possible.
3	+IN	Noninverting Input of the Amplifier.
4	-IN	Inverting Input of the Amplifier.
5	SHDN	Op Amp Shutdown. The threshold for shutdown is approximately 1 V above the negative supply. If the SHDN pin is hard tied to -V <sub>S</sub> or floating, the amplifier is active. If the SHDN pin is asserted high (V <sub>SHDN</sub> > -V <sub>S</sub> + 1.5 V), the amplifier is placed in a shutdown state, and the output of the amplifier goes to a high impedance state. If the SHDN pin is left floating, it is recommended to connect a small capacitor of 1 nF between the SHDN pin and the -V <sub>S</sub> pin to prevent signals from the -IN pin from capacitively coupling to the SHDN pin.
6	+V <sub>S</sub>	Positive Power Supply. Bypass the +V <sub>S</sub> pin with a capacitance of at least 0.1 μF to a low impedance ground plane, as close to the +V <sub>S</sub> pin as possible.

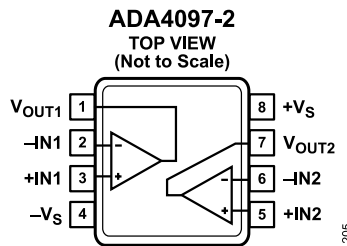
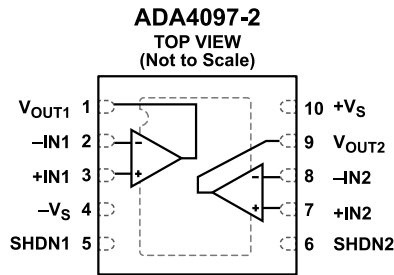

Figure 5. Pin Configuration for ADA4097-2 8-Lead SOIC\_N and 8-Lead MSOP

Table 7. Pin Function Descriptions for ADA4097-2 8-Lead SOIC\_N and 8-Lead MSOP

Pin No.	Mnemonic	Description
1	V <sub>OUT1</sub>	Amplifier Output, Channel 1.
2	-IN1	Inverting Input of the Amplifier, Channel 1.
3	+IN1	Noninverting Input of the Amplifier, Channel 1.
4	-V <sub>S</sub>	Negative Power Supply. In single-supply applications, the -V <sub>S</sub> pin is normally soldered to a low impedance ground plane. In split-supply applications, bypass the -V <sub>S</sub> pin with a capacitance of at least 0.1 μF to a low impedance ground plane, as close to the -V <sub>S</sub> pin as possible.
5	+IN2	Noninverting Input of the Amplifier, Channel 2.
6	-IN2	Inverting Input of the Amplifier, Channel 2.
7	V <sub>OUT2</sub>	Amplifier Output, Channel 2.
8	+V <sub>S</sub>	Positive Power Supply. Bypass the +V <sub>S</sub> pin with a capacitance of at least 0.1 μF to a low impedance ground plane, as close to the +V <sub>S</sub> pin as possible.

## PIN CONFIGURATIONS AND FUNCTION DESCRIPTIONS



## NOTES

1. EXPOSED PAD. CONNECT THE EXPOSED PAD TO  $-V_S$ . 206

Figure 6. Pin Configuration for ADA4097-2 10-Lead LFCSP

Table 8. Pin Function Descriptions for ADA4097-2 10-Lead LFCSP

Pin No.	Mnemonic	Description
1	$V_{OUT1}$	Amplifier Output, Channel 1.
2	$-IN1$	Inverting Input of the Amplifier, Channel 1.
3	$+IN1$	Noninverting Input of the Amplifier, Channel 1.
4	$-V_S$	Negative Power Supply. In single-supply applications, the $-V_S$ pin is normally soldered to a low impedance ground plane. In split-supply applications, bypass the $-V_S$ pin with a capacitance of at least 0.1 $\mu\text{F}$ to a low impedance ground plane, as close to the $-V_S$ pin as possible.
5	SHDN1	Op Amp Shutdown, Channel 1. The threshold for shutdown is approximately 1 V above the negative supply. If the SHDN1 pin is hard tied to the $-V_S$ pin or floating, the amplifier is active. If the SHDN1 pin is asserted high ( $V_{SHDN} > -V_S + 1.5 \text{ V}$ ), the amplifier is placed in a shutdown state, and the output of the amplifier goes to a high impedance state. If the SHDN1 pin is left floating, it is recommended to connect a small capacitor of 1 nF between the SHDN1 pin and the $-V_S$ pin to prevent signals from the $-IN_x$ pins from capacitively coupling to the SHDN1 pin.
6	SHDN2	Op Amp Shutdown, Channel 2. The threshold for shutdown is approximately 1 V above the negative supply. If the SHDN2 pin is hard tied to the $-V_S$ pin or floating, the amplifier is active. If the SHDN2 pin is asserted high ( $V_{SHDN} > -V_S + 1.5 \text{ V}$ ), the amplifier is placed in a shutdown state, and the output of the amplifier goes to a high impedance state. If the SHDN2 pin is left floating, it is recommended to connect a small capacitor of 1 nF between the SHDN2 pin and the $-V_S$ pin to prevent signals from the $-IN_x$ pins from capacitively coupling to the SHDN2 pin.
7	$+IN2$	Noninverting Input of the Amplifier, Channel 2.
8	$-IN2$	Inverting Input of the Amplifier, Channel 2.
9	$V_{OUT2}$	Amplifier Output, Channel 2.
10	$+V_S$	Positive Power Supply. Bypass the $+V_S$ pin with a capacitance of at least 0.1 $\mu\text{F}$ to a low impedance ground plane, as close to the $+V_S$ pin as possible.
	EPAD	Exposed Pad. Connect the exposed pad to $-V_S$ .

TYPICAL PERFORMANCE CHARACTERISTICS

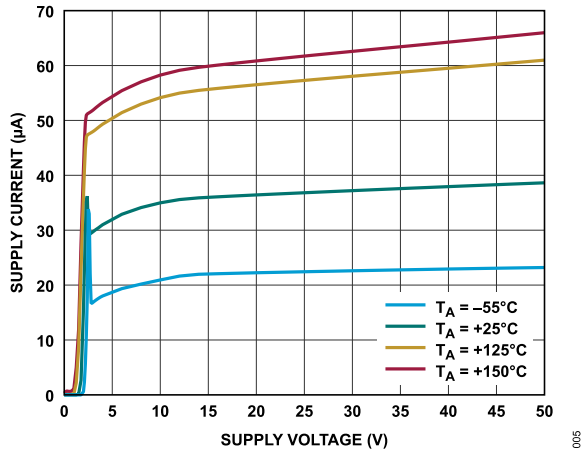

Figure 7. Supply Current vs. Supply Voltage

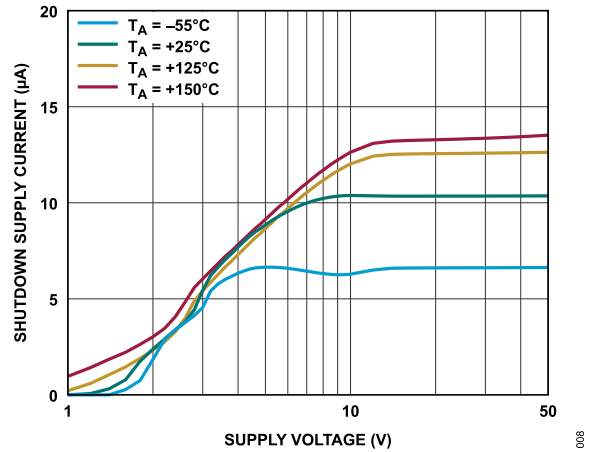

Figure 10. Shutdown Supply Current vs. Supply Voltage

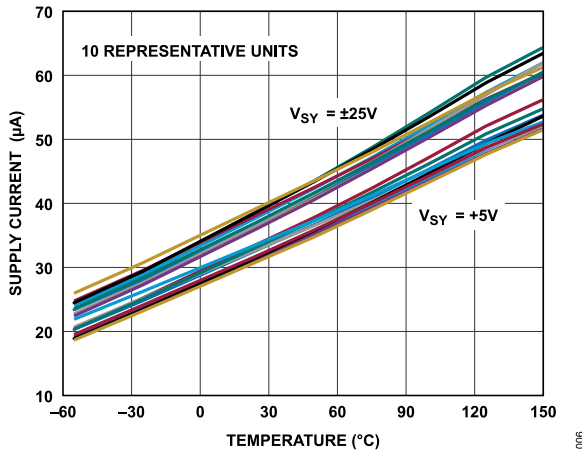

Figure 8. Supply Current vs. Temperature Across Various Supply Voltages

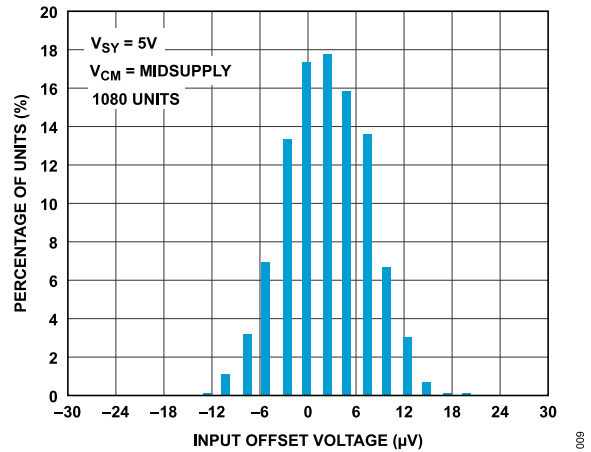

Figure 11. Typical Distribution of Input Offset Voltage,  $V_{SY} = 5\text{ V}$

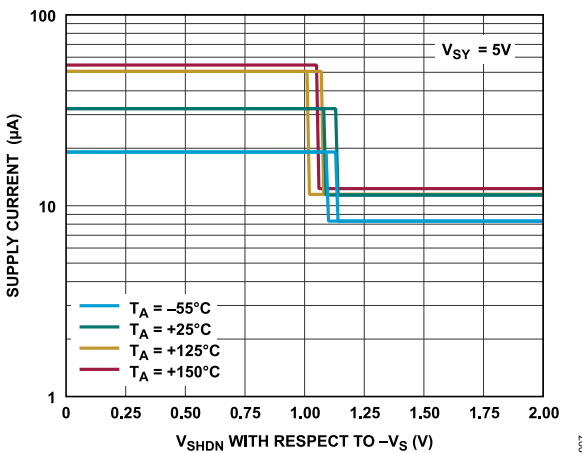

Figure 9. Supply Current vs.  $V_{SHDN}$  with Respect to  $-V_S$

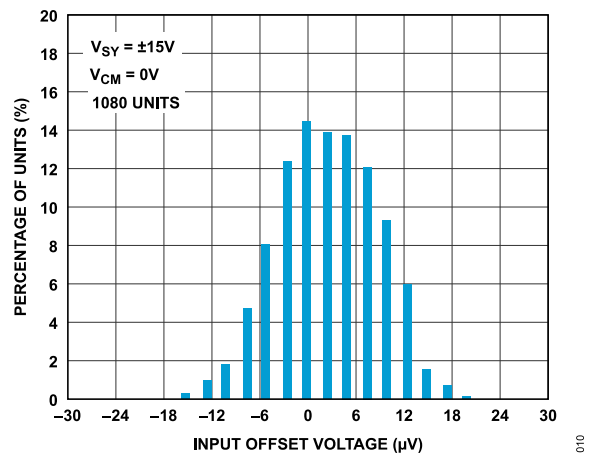

Figure 12. Typical Distribution of Input Offset Voltage with  $V_{SY} = \pm 15\text{ V}$

TYPICAL PERFORMANCE CHARACTERISTICS

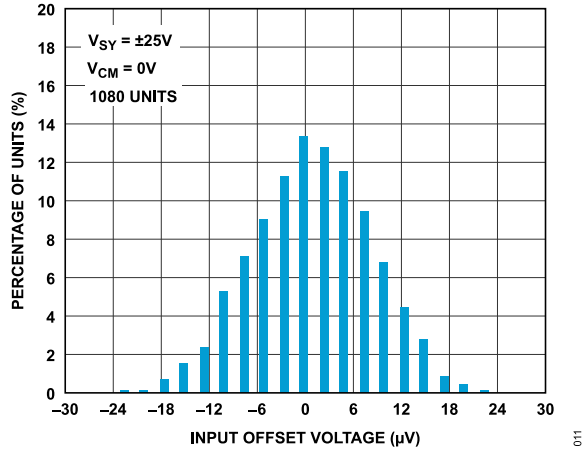

Figure 13. Typical Distribution of Input Offset Voltage with  $V_{SY} = \pm 25 V$

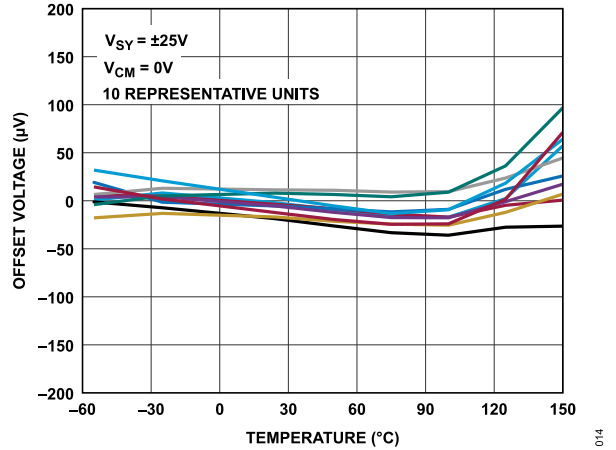

Figure 16. Offset Voltage vs. Temperature with  $V_{SY} = \pm 25 V$

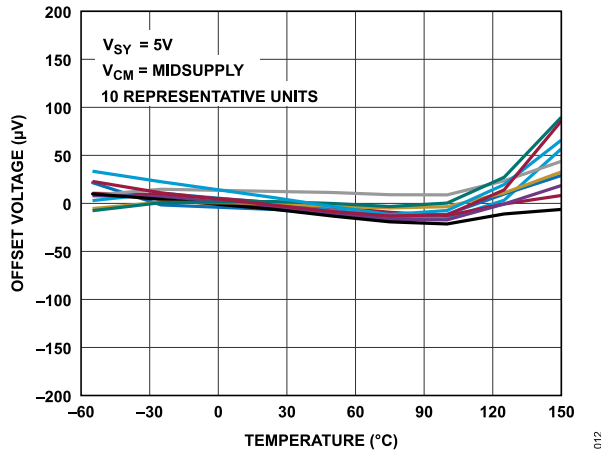

Figure 14. Midsupply Offset Voltage vs. Temperature with  $V_{SY} = 5 V$

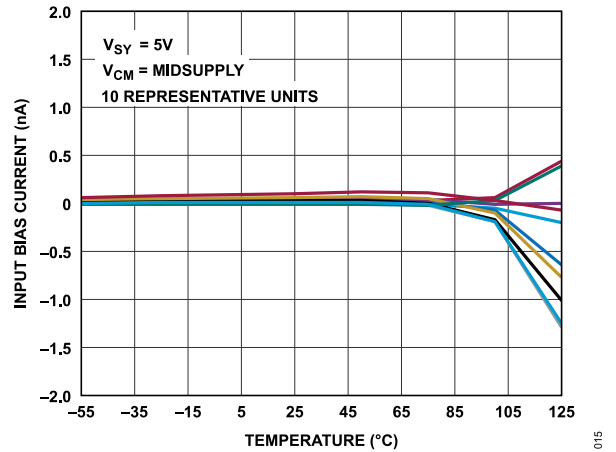

Figure 17. Midsupply Input Bias Current vs. Temperature with  $V_{SY} = 5 V$

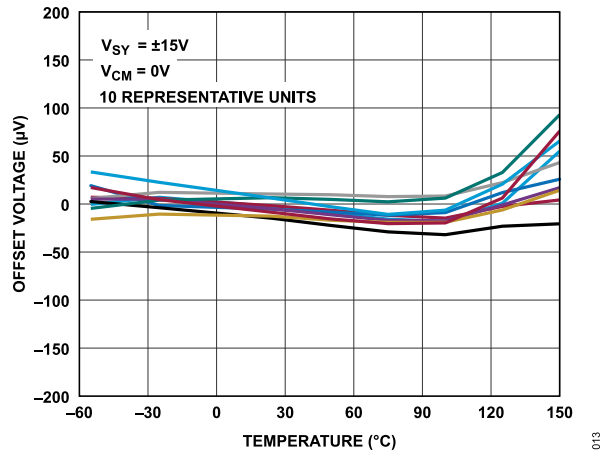

Figure 15. Offset Voltage vs. Temperature with  $V_{SY} = \pm 15 V$

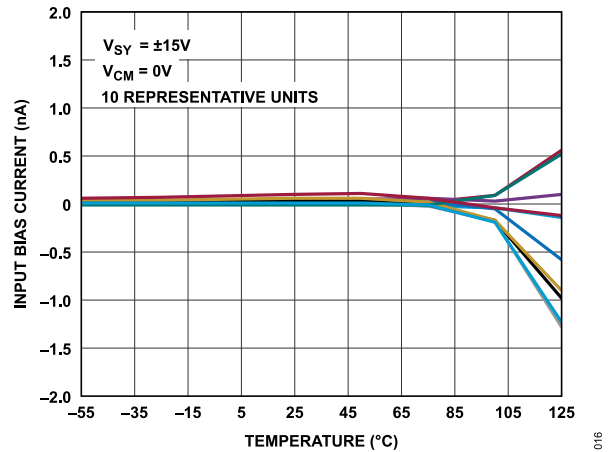

Figure 18. Input Bias Current vs. Temperature with  $V_{SY} = \pm 15 V$

TYPICAL PERFORMANCE CHARACTERISTICS

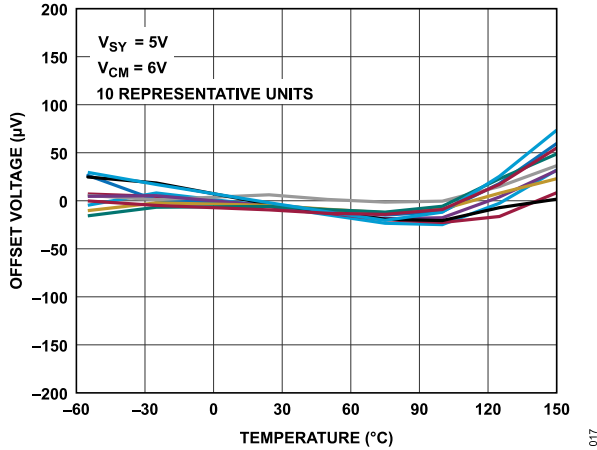

Figure 19. Offset Voltage vs. Temperature with  $V_{CM} = 6\text{ V}$ , Over-The-Top

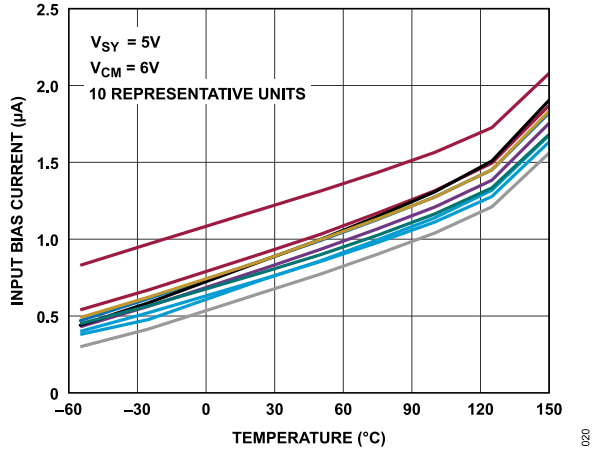

Figure 22. Input Bias Current vs. Temperature with  $V_{CM} = 6\text{ V}$ , Over-The-Top

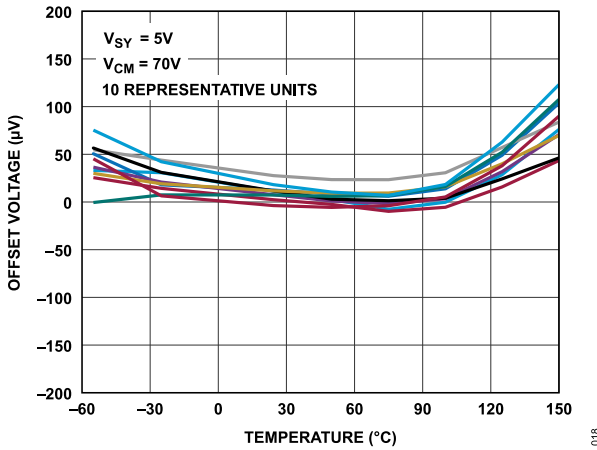

Figure 20. Offset Voltage vs. Temperature with  $V_{CM} = 70\text{ V}$

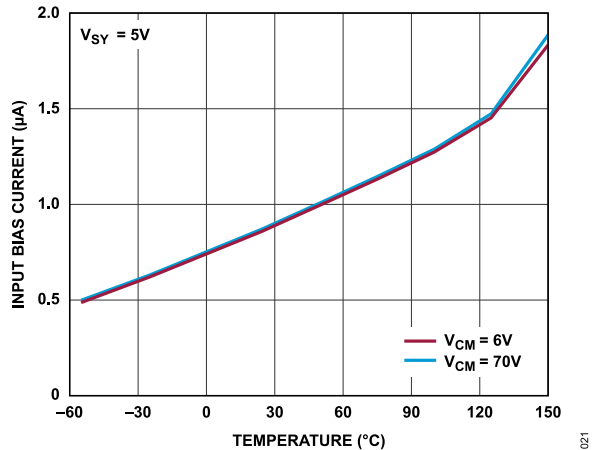

Figure 23. Input Bias Current vs. Temperature Across Various  $V_{CM}$

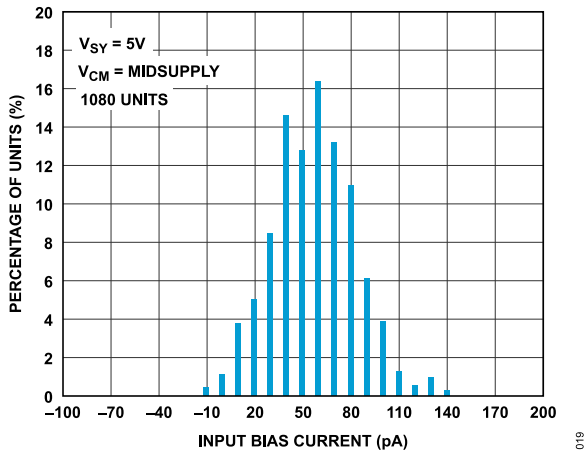

Figure 21. Typical Distribution of Input Bias Current,  $V_{SY} = 5\text{ V}$

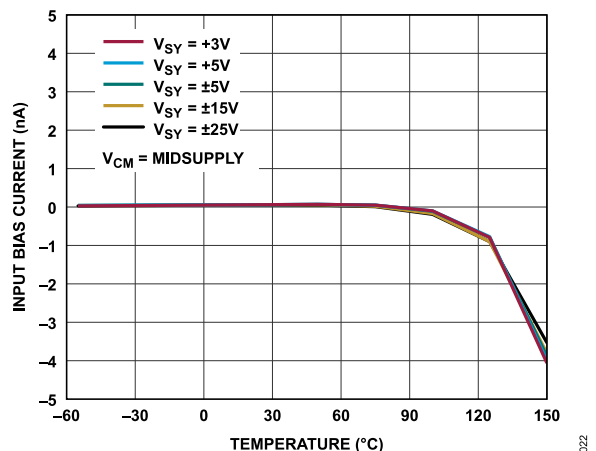

Figure 24. Input Bias Current vs. Temperature Across Various Supply Voltages

TYPICAL PERFORMANCE CHARACTERISTICS

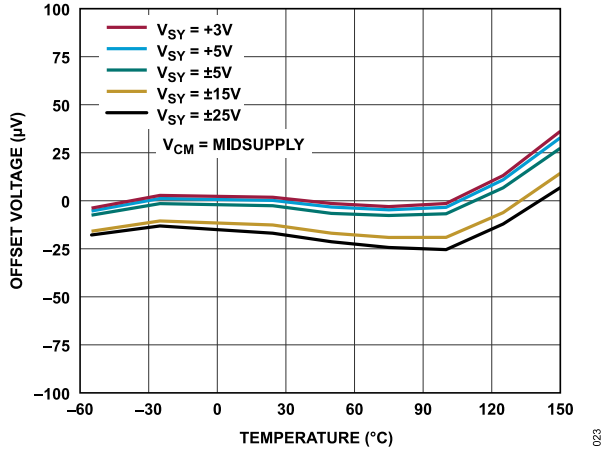

Figure 25. Offset Voltage vs. Temperature Across Various Supply Voltages

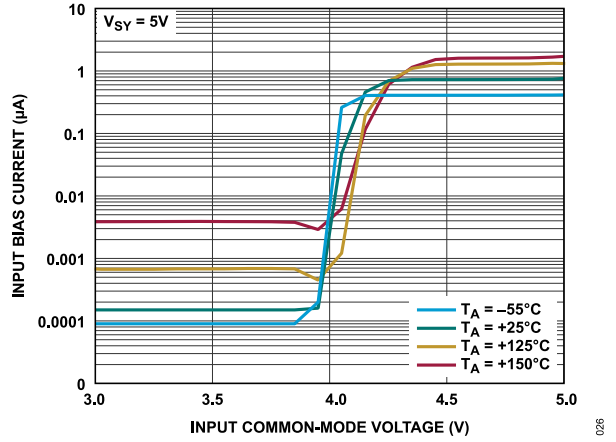

Figure 28. Input Bias Current vs. Input Common-Mode Voltage from Normal Operation to Over-The-Top Operation

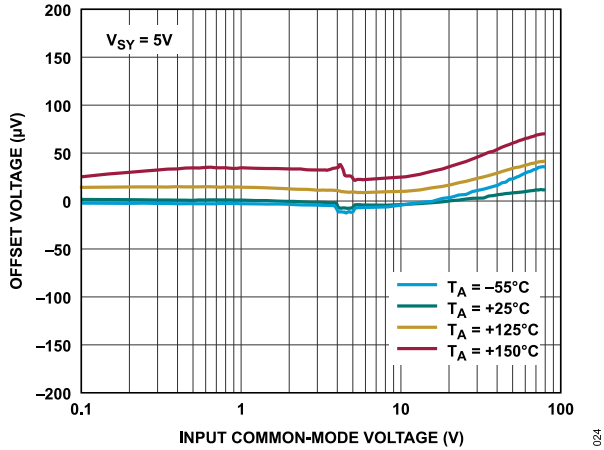

Figure 26. Offset Voltage vs. Input Common-Mode Voltage from Normal Operation to Over-The-Top Operation

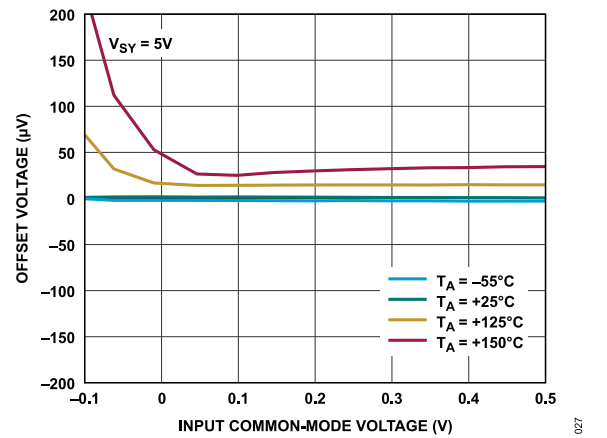

Figure 29. Offset Voltage vs. Input Common-Mode Voltage for Ground Sensing Applications

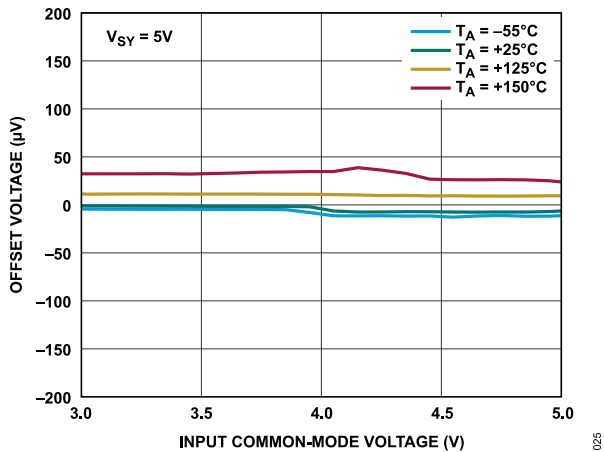

Figure 27. Offset Voltage vs. Input Common-Mode Voltage over the Input Common-Mode Range

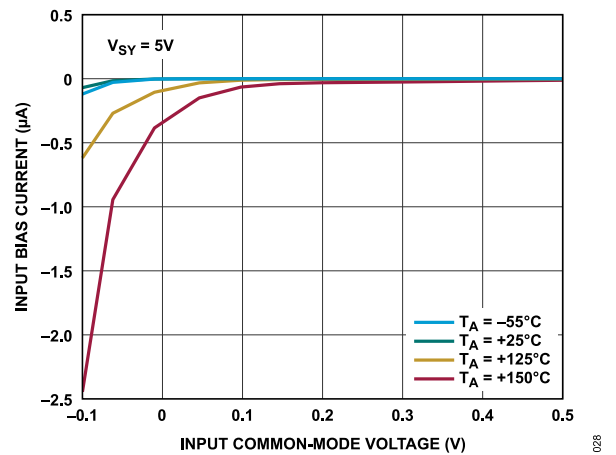

Figure 30. Input Bias Current vs. Input Common-Mode Voltage for Ground Sensing Applications

TYPICAL PERFORMANCE CHARACTERISTICS

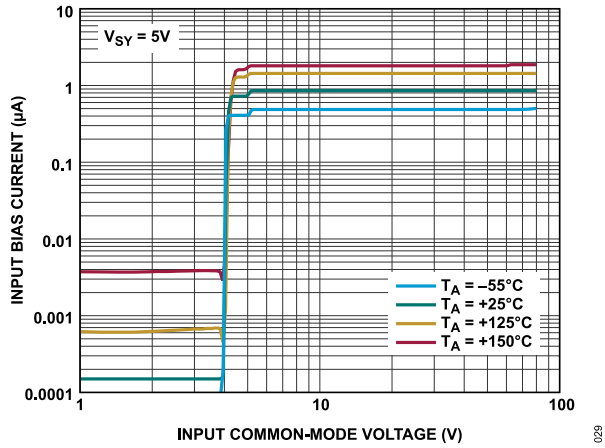

Figure 31. Input Bias Current vs. Input Common-Mode Voltage

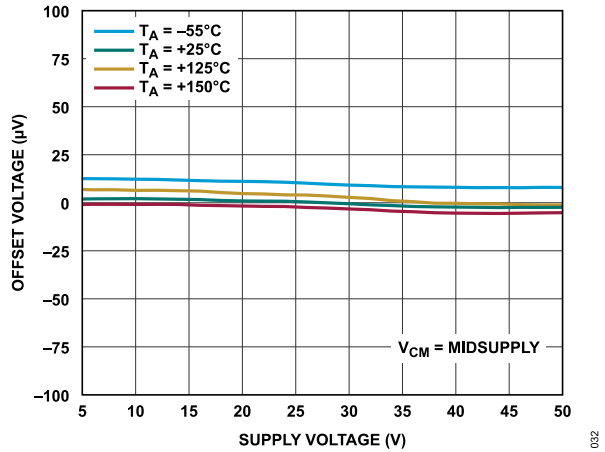

Figure 34. Offset Voltage vs. Supply Voltage

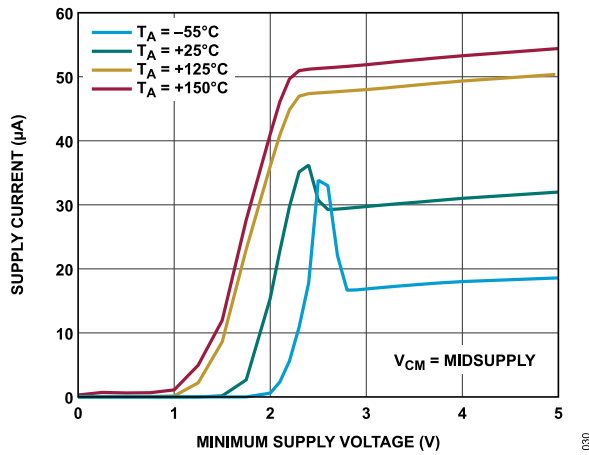

Figure 32. Supply Current vs. Minimum Supply Voltage

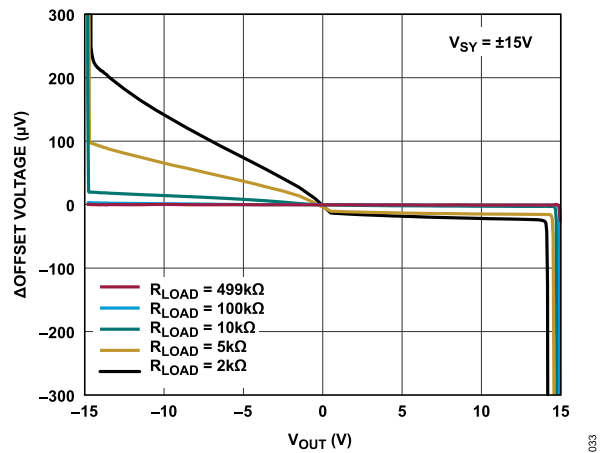

Figure 35.  $\Delta$ Offset Voltage vs.  $V_{OUT}$  Across Various  $R_{LOAD}$

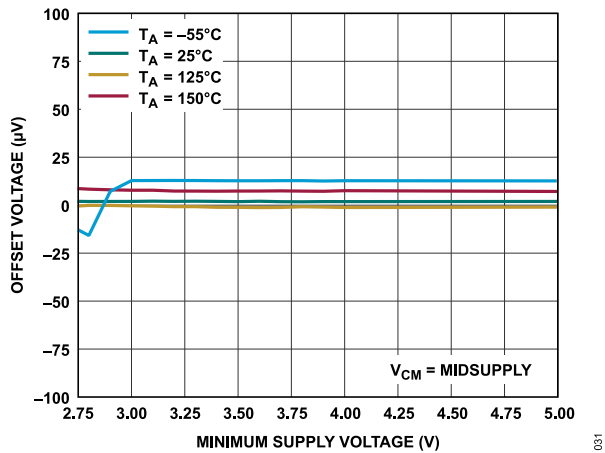

Figure 33. Offset Voltage vs. Minimum Supply Voltage

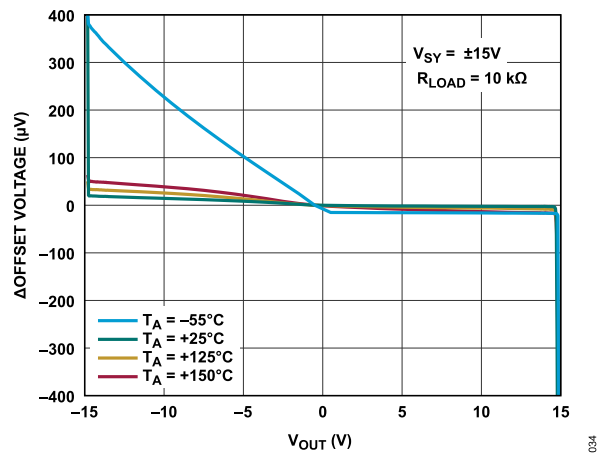

Figure 36.  $\Delta$ Offset Voltage vs.  $V_{OUT}$  Across Various Temperatures



TYPICAL PERFORMANCE CHARACTERISTICS

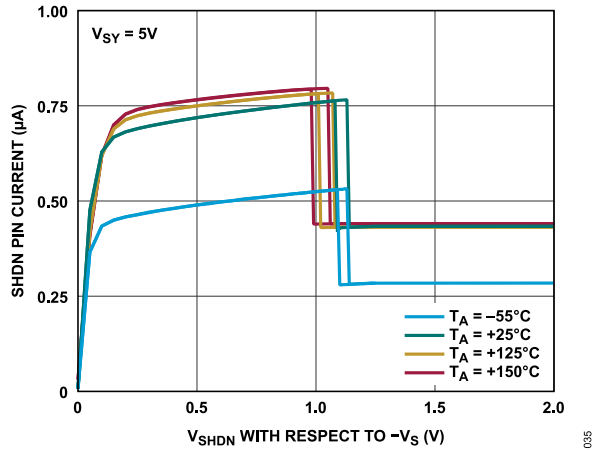

Figure 37. SHDN/SHDNx Pin Current ( $I_{SHDN}$ ) vs.  $V_{SHDN}$  with Respect to  $-V_S$  over Various Temperatures

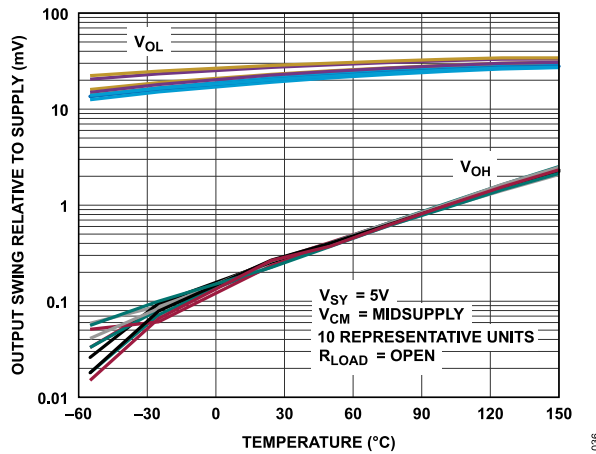

Figure 38. Output Swing Relative to Supply vs. Temperature

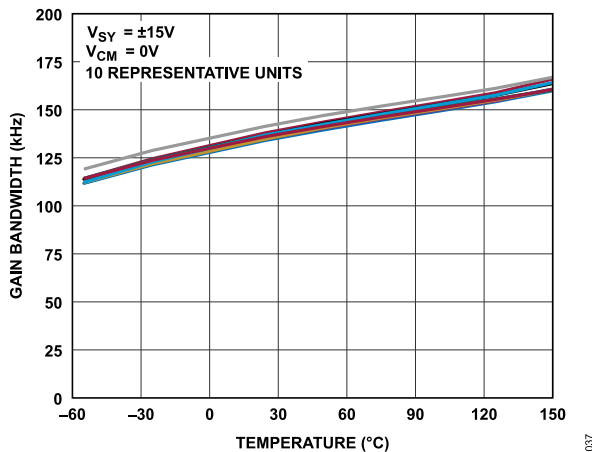

Figure 39. Gain Bandwidth vs. Temperature

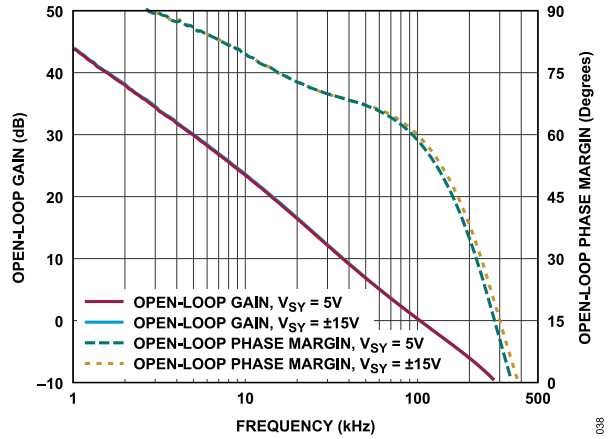

Figure 40. Open-Loop Gain and Open-Loop Phase Margin vs. Frequency

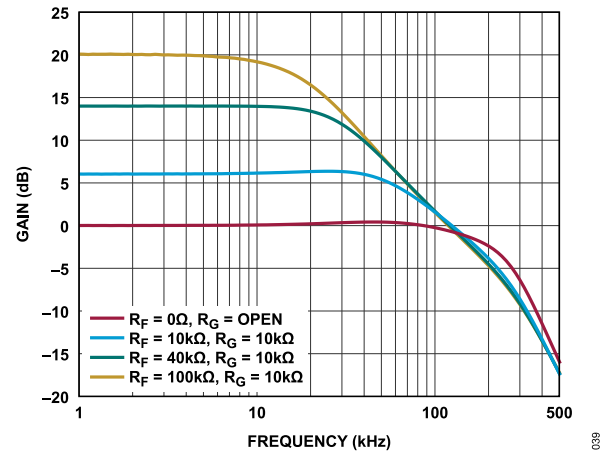

Figure 41. Noninverting Small Signal Frequency Response

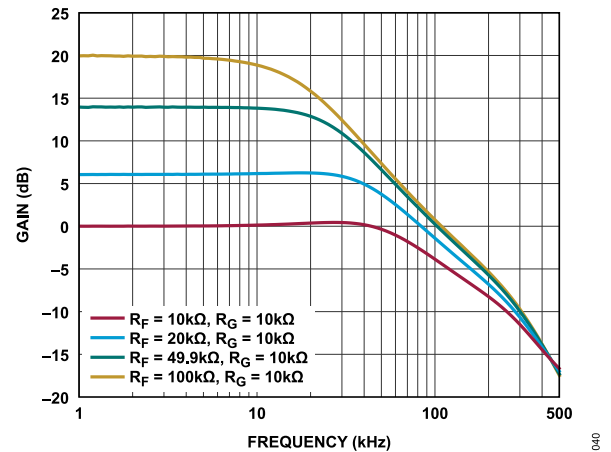

Figure 42. Inverting Small Signal Frequency Response

TYPICAL PERFORMANCE CHARACTERISTICS

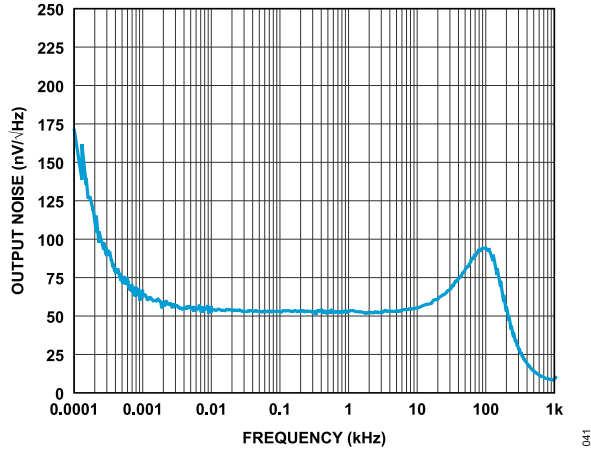

Figure 43. Output Noise vs. Frequency

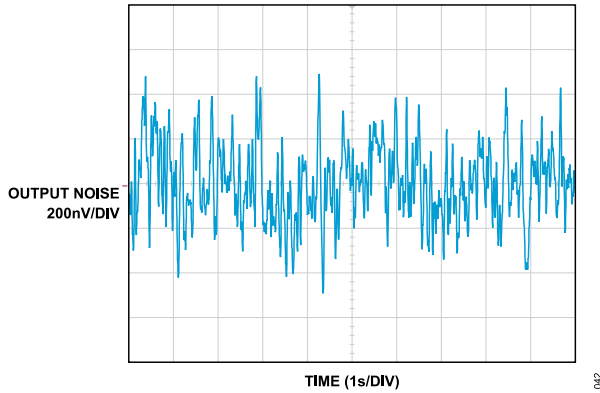

Figure 44. 0.1 Hz to 10 Hz Noise

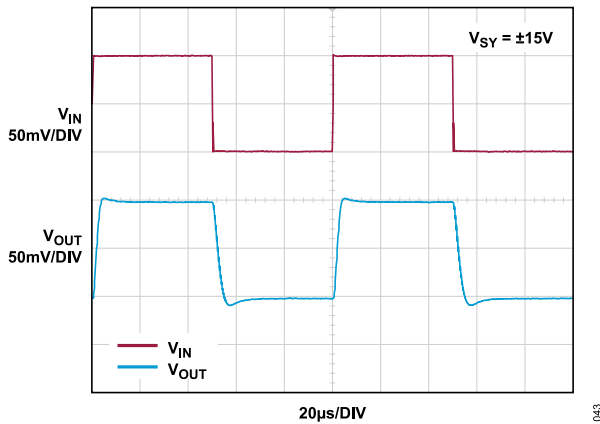

Figure 45. Unity-Gain Small Signal Step Response

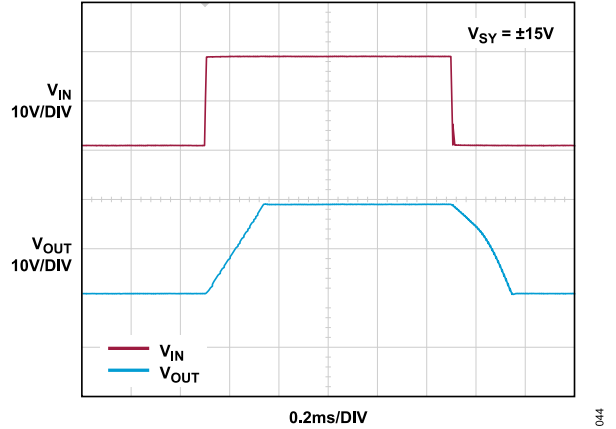

Figure 46. Unity-Gain Large Signal Step Response

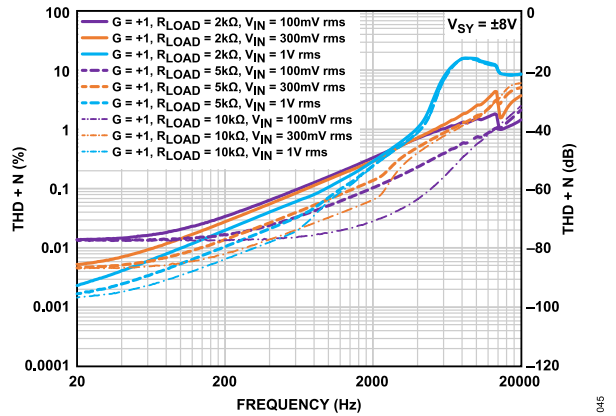

Figure 47. THD + N vs. Frequency over Load

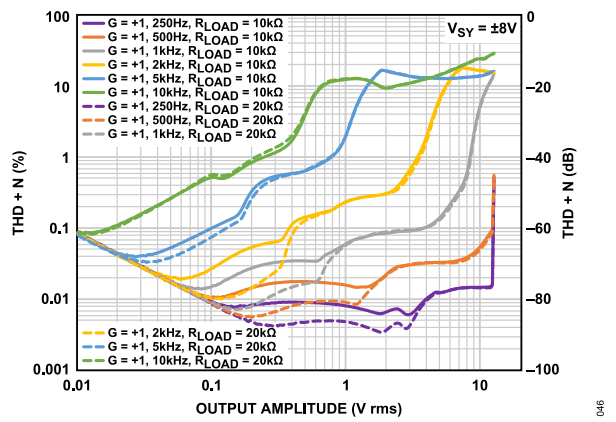

Figure 48. THD + N vs. Output Amplitude

TYPICAL PERFORMANCE CHARACTERISTICS

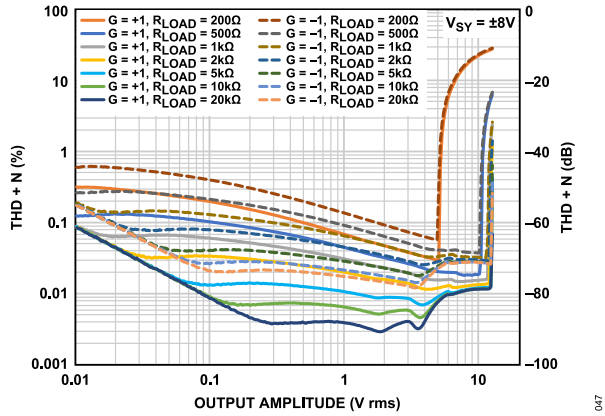

Figure 49. THD + N vs. Output Amplitude and Load

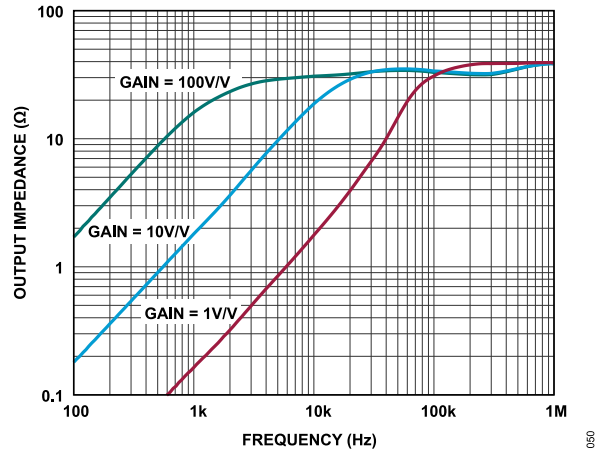

Figure 52. Output Impedance vs. Frequency

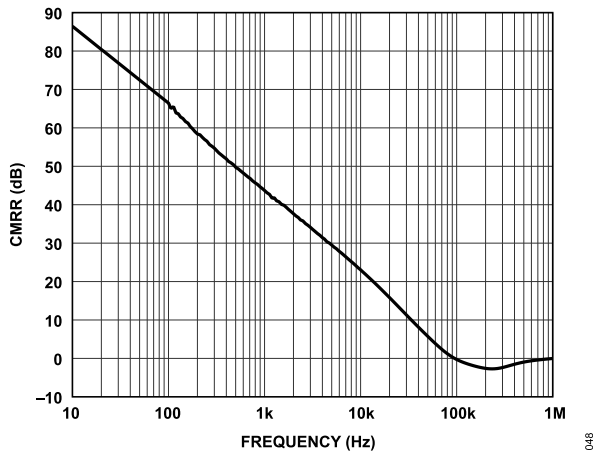

Figure 50. CMRR vs. Frequency

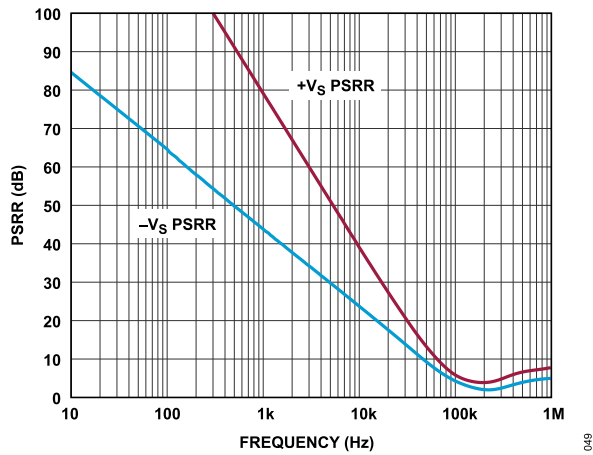

Figure 51. PSRR vs. Frequency

**THEORY OF OPERATION**

The ADA4097-1/ADA4097-2 are robust, voltage feedback amplifiers that combine unity-gain stability with low offset, low offset drift, and 53 nV/√Hz of input voltage noise. Figure 55 shows a simplified schematic of the devices. The ADA4097-1/ADA4097-2 have two input stages: a common emitter differential input stage consisting of the Q1 and Q2 PNP transistors that operate with the inputs biased between  $-V_S$  and 1 V below  $+V_S$ , and a common base input stage that consists of the Q3 to Q6 PNP transistors that operate when the common-mode input is biased  $>+V_S - 1$  V. These input stages result in two distinct operating regions, as shown in Figure 53.

the common emitter PNP input stage is active and the input bias current is typically  $<0.3$  nA. When the common-mode input is above  $+V_S - 1$  V, the Q9 transistor turns on, which diverts bias current away from the common emitter differential input pair to the mirror that consists of M3 and M4. The current from M4 biases the common base differential input pair (Q3 to Q6). The Over-The-Top input pair operates in a common base configuration and the input bias current increases to  $\sim 0.8$   $\mu$ A. The offset voltages of both input stages are tightly trimmed and are specified in Table 1 and Table 2.

As the input common-mode transitions to the Over-The-Top region, the input CMRR degrades slightly when compared to the rest of the input common-mode range, as shown in Figure 54.

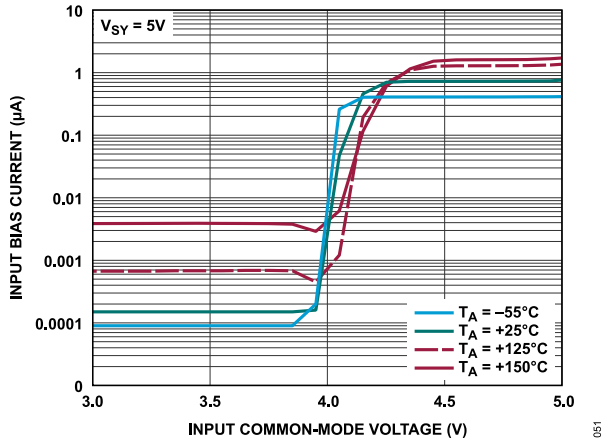

Figure 53. Input Bias Current vs. Input Common-Mode Voltage over Temperature,  $V_{SY} = 5$  V

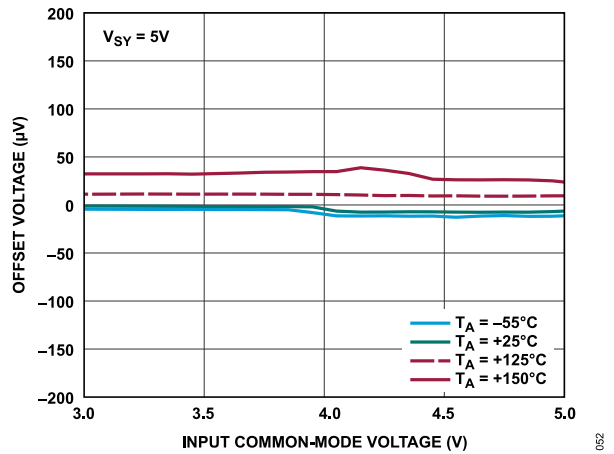

Figure 54. Offset Voltage vs. Input Common-Mode Voltage over Temperature,  $V_{SY} = 5$  V

For common-mode input voltages that are approximately 1 V below the  $+V_S$  supply, where Q1 and Q2 are active (see Figure 53),

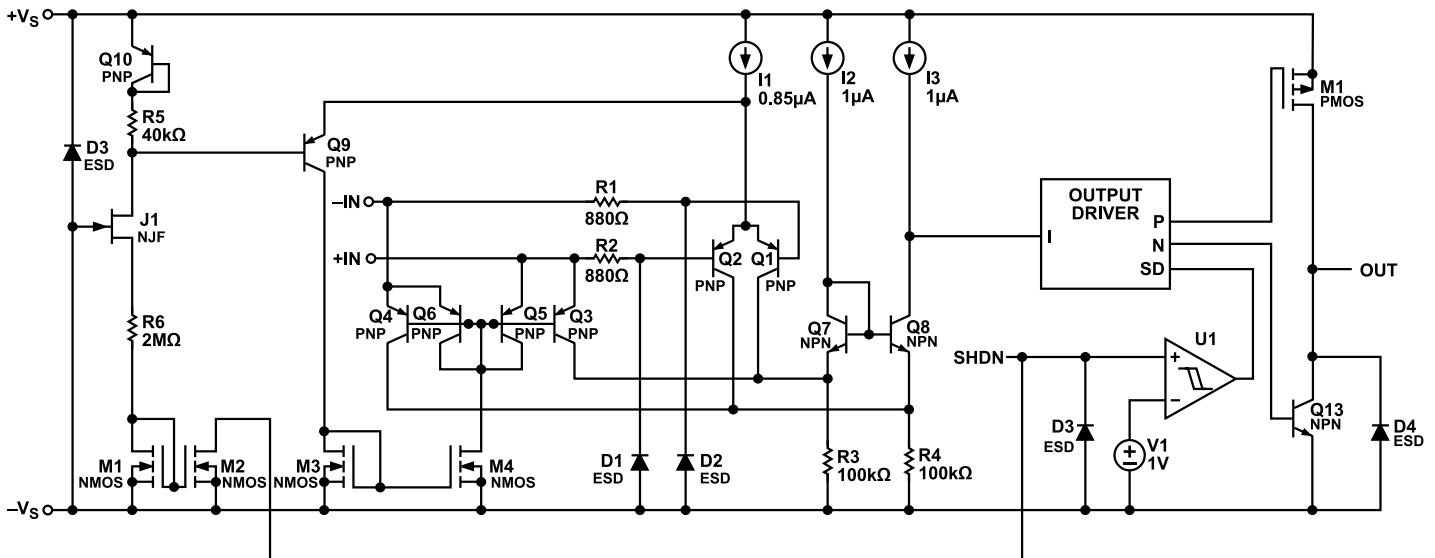

Figure 55. Simplified ADA4097-1/ADA4097-2 Schematic

**THEORY OF OPERATION**

**INPUT PROTECTION**

The inputs are protected against temporary voltage excursions to 15 V below  $-V_S$  (see Figure 56) by internal 880  $\Omega$  resistors (see Figure 55). These resistors limit the current in the series D1 diode and D2 diode that are tied to the bases of the Q1 and Q2 transistors, respectively. Adding additional external series resistance extends the protection to >15 V below  $-V_S$ , at the cost of stability and added thermal noise. The input stage of the ADA4097-1/ADA4097-2 incorporates phase reversal protection to prevent the output from phase reversing for inputs below  $-V_S$ . The ADA4097-1/ADA4097-2 op amp does not have clamping diodes between the inputs and can be differentially over-driven up to 80 V without damage, inducing parametric shifts, or drawing appreciable input current. Figure 57 summarizes the input fault types that can be applied to the ADA4097-1/ADA4097-2 without compromising input integrity.

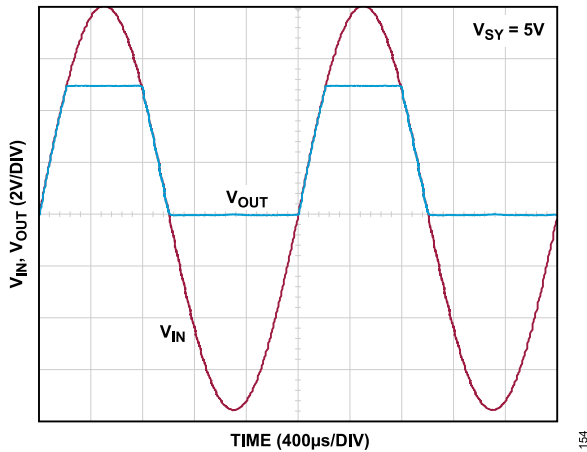

Figure 56. ADA4097-1/ADA4097-2 as Unity-Gain Buffer with Noninverting Input Driven Beyond the Supply ( $V_{SY} = 5\text{ V}$ )

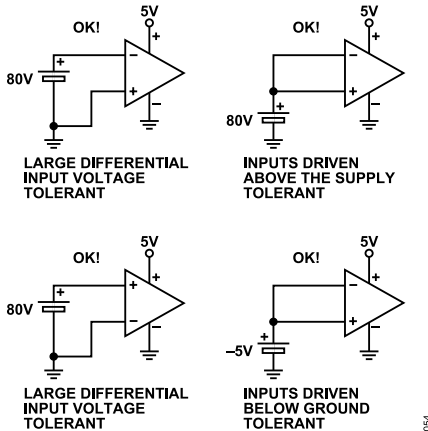

Figure 57. ADA4097-1/ADA4097-2 Fault Tolerant Conditions

**OVER-THE-TOP OPERATION CONSIDERATIONS**

When the ADA4097-1/ADA4097-2 input common-modes are biased near or  $>+V_S$  supply, the amplifiers operate in the Over-The-Top configuration. The differential input pair that controls amplifier operation is the common base pair, Q3 to Q6 (see Figure 55).

Input bias currents change from  $\pm 0.3\text{ nA}$  in normal operation to approximately  $0.8\text{ }\mu\text{A}$  in Over-The-Top operation when the input stage transitions from common emitter to common base. The Over-The-Top input bias currents are well matched, and the associated offset is typically  $<50\text{ nA}$ . Ensure that the impedance connected to the inverting and noninverting inputs is well matched to avoid any input bias current induced voltage offsets.

Differential input impedance,  $R_{IN}$  (see Figure 58), decreases from  $>10\text{ M}\Omega$  in normal operation to  $\sim 60\text{ k}\Omega$  in Over-The-Top operation (see Table 1 and Table 2).

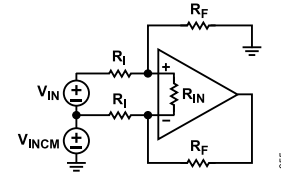

Figure 58. Difference Amplifier Configured for Normal Operation and Over-The-Top Operation ( $R_1$  Is a Gain Setting Resistor)

This  $R_{IN}$  resistance appears across the summing nodes in Over-The-Top operation due to the configuration of the common base input stage.

The  $R_{IN}$  value is derived from the specified  $I_B$  that flows to the op amp inputs, as expressed in the following equation:

$$R_{IN} = 2kT/(qI_B)$$

where:

$k$  is Boltzmann constant.

$T$  is the operating temperature.

$q$  is the charge of an electron.

$I_B$  is the operating input bias current in Over-The-Top operation.

The inputs are biased proportional to absolute temperature. Therefore,  $R_{IN}$  is relatively constant with temperature. This resistance appears across the summing nodes of the amplifier, which is forced to 0 V differentially by the feedback action of the amplifier and can seem relatively harmless. However, depending on the configuration, this input resistance can boost the noise gain, lower overall amplifier loop gain and closed-loop bandwidth, and raise output noise. The singular benefit of this configuration is an increase in closed-loop amplifier stability.

In normal mode ( $-V_S < V_{CM} < +V_S - 1\text{ V}$ ),  $R_{IN}$  is typically large compared to the value of the gain setting resistors ( $R_F$  and  $R_1$ ), and  $R_{IN}$  can be ignored.

In this case, the noise gain is defined by the following equation:

## THEORY OF OPERATION

$$\text{Noise Gain} = 1 + R_F/R_I$$

When the amplifiers transition to Over-The-Top operation with the input common-mode biased near or above the  $+V_S$  supply, consider the value of  $R_{IN}$ .

The noise gain of the amplifiers increases as shown in the following equation:

$$\text{Noise Gain}_{OTT} = \left( \left( 1 + \frac{R_F}{R_I \parallel R_{IN} + R_I \parallel R_F} \right) \times \left( 1 + \frac{R_I \parallel R_F}{R_{IN}} \right) \right)$$

where  $\text{Noise Gain}_{OTT}$  is the Over-The-Top noise gain.

The dc closed-loop gain remains mostly unaffected ( $R_F/R_I$ ). However, the loop gain of the amplifier decreases, as expressed in the following equation:

$$\frac{A_{OL}}{1 + \frac{R_F}{R_I}} \text{ to } \frac{A_{OL}}{\text{Noise Gain}_{OTT}}$$

Likewise, the closed-loop bandwidth ( $BW_{CLOSED\_LOOP}$ ) of the amplifier changes going from normal operation to Over-The-Top operation.

In normal operation,

$$BW_{CLOSED\_LOOP} \approx \frac{GBP}{1 + \frac{R_F}{R_I}}$$

In Over-The-Top operation,

$$BW_{CLOSED\_LOOP} \approx \frac{GBP}{\text{Noise Gain}_{OTT}}$$

Output voltage noise density ( $e_{no}$ ) is impacted when the device transitions from normal operation to Over-The-Top operation. Resistor noise is neglected in both modes of operation in the following equations.

In normal operation, neglecting resistor noise,

$$e_{no} \cong e_n \left( 1 + \frac{R_F}{R_I} \right)$$

where  $e_n$  is input referred voltage noise density.

In Over-The-Top operation, neglecting resistor noise,

$$e_{no} \cong e_n \times \text{Noise Gain}_{OTT}$$

## OUTPUT

The output of the ADA4097-1/ADA4097-2 can swing rail-to-rail to within 15 mV of either supply with no load. The output can source 30 mA and sink 40 mA. The amplifiers are internally compensated to drive at least 200 pF of load capacitance ( $C_{LOAD}$ ). Adding a series resistance of 50  $\Omega$  between the output and larger capacitive loads extends the capacitive drive capability of the amplifier.

If the ADA4097-1/ADA4097-2 enter shutdown, the  $V_{OUT}$  (ADA4097-1) pin or the  $V_{OUTx}$  pins (ADA4097-2) appears as high impedance with two steering diodes connected to either supply. In this state, the output typically leaks <5 nA.

## SHUTDOWN PINS (SHDN AND SHDNx)

The ADA4097-1/ADA4097-2 have dedicated shutdown pins (SHDN for the ADA4097-1, and SHDN1 and SHDN2 for the 10-lead LFCSP ADA4097-2 only) to place the amplifiers in a low power shutdown state when asserted high. A logic high is defined by a voltage  $\geq 1.5$  V applied to the SHDN pin and SHDNx pins with respect to the  $-V_S$  pin. In shutdown, the amplifiers draw <20  $\mu$ A of supply current (see Figure 9) and the  $V_{OUT}$  pin (ADA4097-1) or  $V_{OUTx}$  pins (ADA4097-2) are placed in a high impedance state.

The SHDN pin and SHDNx pins can be driven beyond the  $+V_S$  supply up to the absolute maximum voltage (60 V with respect to  $-V_S$ ) and draw little current (<2.5  $\mu$ A). For normal active amplifier operation, the SHDN pin and SHDNx pins can be floated or driven by an external low voltage source (within 0.5 V of  $-V_S$ ). If the SHDN pin and SHDNx pins are left floating, an internal current source (~600 nA) pulls these pins to  $-V_S$ , which places the amplifiers into a default, active amplifying state. Because of the close proximity of the  $-IN$  pin (ADA4097-1) and  $-INx$  pins (ADA4097-2) and the SHDN pin and SHDNx pins, respectively, fast edges on the  $-IN$  pin and  $-INx$  pins can ac-couple to the adjacent high impedance SHDN pin and SHDNx pins, inadvertently placing the devices in shutdown. If this scenario is a concern, add a 1 nF capacitor between the SHDN pin and SHDNx pins and the  $-V_S$  pin.

Alternatively, the amplifiers can be effectively placed in a low power state by removing  $+V_S$ . In this low power state, the inputs typically leak <1 nA with either the  $\pm IN$  pins (ADA4097-1) or  $\pm INx$  pins (ADA4097-2) biased between  $-V_S$  and 70 V above  $-V_S$ . If the  $\pm IN$  pins and  $\pm INx$  pins are taken below  $-V_S$ , these pins appear as a diode connected to the  $-V_S$  supply in series with a resistance of 880  $\Omega$ . In this condition, limit the current to <10 mA.

Using an external source to drive the output beyond either  $\pm V_S$  supply under shutdown conditions can produce unlimited current and can damage the devices.

APPLICATIONS INFORMATION

LARGE RESISTOR GAIN OPERATION

The ADA4097-1/ADA4097-2 have approximately 3.5 pF of input capacitance ( $C_{IN}$ ).

The parallel combination of the  $R_F$  and  $R_G$  on the inverting input can combine with  $C_{IN}$  to form a pole that can reduce bandwidth, cause frequency response peaking, or produce oscillations (see Figure 60). To mitigate these consequences, place a feedback capacitor ( $C_F$ ) with a value of  $C_F > C_{IN}(R_G/R_F)$  in parallel with  $R_F$  for summing node impedances  $>200\text{ k}\Omega$  ( $R_F || R_G > 200\text{ k}\Omega$ ). This capacitor placement cancels the input pole and optimizes dynamic performance (see Figure 59).

For applications where the noise gain is unity ( $R_G \rightarrow \infty$ ), and the feedback resistor exceeds 200 k $\Omega$ ,  $C_F \geq C_{IN}$ . Optimize PCB layouts to keep layout related summing node capacitance to an absolute minimum.

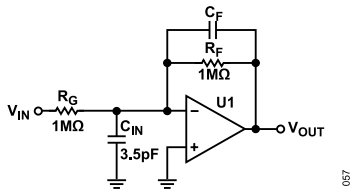

Figure 59. Inverting Gain Schematic

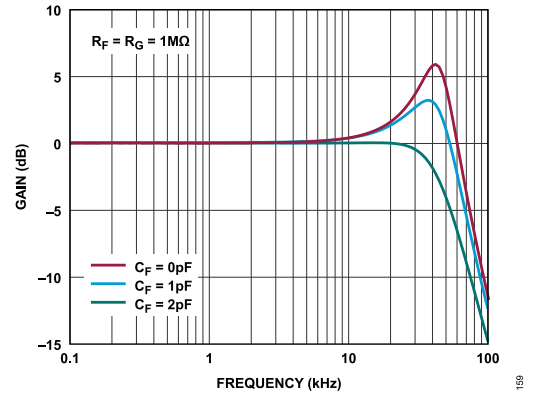

Figure 60. Inverting Gain of 1, Small Signal Frequency Response,  $R_F = R_G = 1\text{ M}\Omega$

RECOMMENDED VALUES FOR VARIOUS GAINS

Table 9 is a reference for determining various recommended gains and associated noise performance. The total impedance seen at the inverting input is kept to  $<200\text{ k}\Omega$  for gains  $>1$  to maintain ideal small signal bandwidth.

Table 9. Gains and Associated Recommended Resistor Values ( $T_A = 25^\circ\text{C}$ )

Gain	$R_F$ (k $\Omega$ )	$R_G$ (k $\Omega$ )	$C_F$ (pF)	Approximate -3 dB Frequency (kHz)	Total System Noise (nV/ $\sqrt{\text{Hz}}$ at 1 kHz), Referred to Input
+1	0	Not applicable	Not applicable	220	53
+2	10	10	0	80	54
+2	100	100	0	100	59.5
+5	10	40.2	0	33.5	53.2
+10	10	90	0	18	53.2
-1	10	10	0	87	108
-1	100	100	0	95	119
-1	1000	1000	2	55	215
-2	10	20	0	56	80
-5	10	49.9	0	29	64.2
-10	10	100	0	17	58.5



APPLICATIONS INFORMATION

NOISE

To analyze the noise performance of an amplifier circuit, identify the noise sources, and then determine if each source has a significant contribution to the overall noise performance of the amplifier. To simplify the noise calculations, noise spectral densities (NSDs) are used rather than actual voltages, to leave bandwidth out of the expressions. NSD is generally expressed in nV/√Hz and is equivalent to the noise in a 1 Hz bandwidth.

The noise model shown in Figure 61 has six individual noise sources: the Johnson noise of the three resistors (R1 to R3), the op amp voltage noise, and the current noise ( $I_{N\pm}$ ) in each input of the amplifier. Each noise source has its own contribution to the noise at the output. Noise is generally specified as referring to input (RTI), but it is often simpler to calculate the noise referred to the output (RTO), and then divide by the noise gain to obtain the RTI noise.

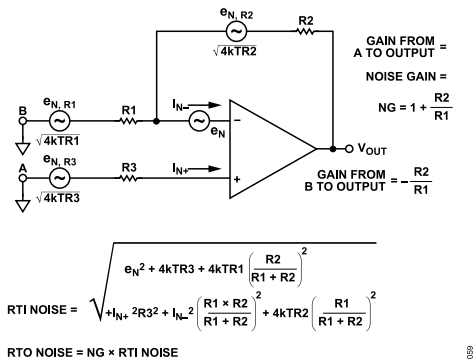

Figure 61. Op Amp Noise Analysis Model

Assuming  $I_{N+} = I_{N-} = I_N$ , the equation for RTI noise can be simplified to the following form:

$$RTI\ Noise = \sqrt{e_n^2 + e_{n,R}^2 + (I_N R_{EQ})^2}$$

$$e_{n,R} = \sqrt{4kTR_{EQ}}$$

$$R_{EQ} = R3 + R1 || R2$$

where:

$e_n$  is the op amp voltage noise.

$e_{n,R}$  is the thermal noise contribution of the surrounding R1 to R3 resistors.

$R_{EQ}$  is the equivalent input resistance.

$k$  is Boltzmann's constant ( $1.38 \times 10^{-23}$  J/K).

$T$  is the absolute temperature in Kelvin.

A 50 Ω resistor generates a Johnson noise of 1 nV/√Hz at 25°C.

For optimal performance, the lower bound of resistance in a feedback network is determined by the amount of quiescent power and distortion that can be tolerated. The upper bound is determined by the resistor and current noise density. The ADA4097-1/ADA4097-2 has an  $e_n$  of 53 nV/√Hz.

If resistor and current noise contributions are less than half this value, the  $e_n$  introduced by the op amp dominates and provides optimal noise performance of the device.

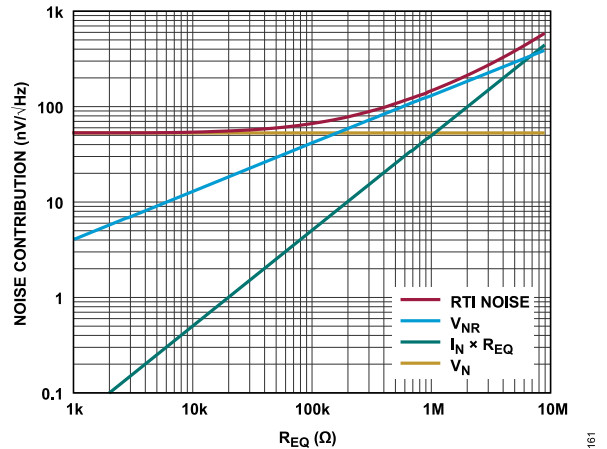

Figure 62. Noise Contributions vs. Equivalent Input Resistance

For the ADA4097-1/ADA4097-2, this lower bound of resistance in the feedback network is about 40 kΩ. For the amplifier configuration shown in Figure 61,  $R_{EQ} < 40$  kΩ provides stable noise performance. If noise performance is not important,  $e_n$  is typically fixed for a given  $T_A$ ,  $e_{n,R}$  increases with the square root of the resistor value, and the  $I_N \times R_{EQ}$  resistance increases linearly, but does not impact total noise until it approaches the value of  $e_{n,R}$ . With  $R_{EQ} < \sim 6$  MΩ,  $e_{n,R}$  is larger than  $I_N \times R_{EQ}$ . A safe value for  $R_{EQ} < 2$  MΩ to ensure that  $I_N$  is not the majority contributor to total noise seen by the input.

Figure 62 shows the noise contributions for the range of resistance values discussed in this section.

DISTORTION

There are two main contributors of distortion in op amps: output crossover distortion as the output transitions from sourcing to sinking, and distortion caused by nonlinear common-mode rejection. If the op amp is operating in an inverting configuration, there is no common-mode induced distortion. If the op amp is operating in the noninverting configurations within the normal input common-mode range ( $-V_S$  to  $+V_S - 1$  V), distortion is acceptable. When the inputs transition from normal to Over-The-Top operation or vice versa, a significant degradation occurs in linearity due to the change of input circuitry.

As  $R_{LOAD}$  decreases, distortion increases due to a net decrease in loop gain and greater signal swings internal to the amplifier that are necessary to drive the load. The lowest distortion can be achieved with the ADA4097-1/ADA4097-2 operating in Class A operation in an inverting configuration, with the input common-mode biased at midsupply.



## APPLICATIONS INFORMATION

## POWER DISSIPATION AND THERMAL SHUTDOWN

The ADA4097-1/ADA4097-2 can drive heavy loads on power supplies up to  $\pm 25$  V. Therefore, ensure that  $T_J$  on the IC does not exceed  $175^\circ\text{C}$ . See Table 4 for the  $\theta_{JA}$  of each package type.

Junction temperatures exceeding  $125^\circ\text{C}$  promote accelerated aging. Reliability of the ADA4097-1/ADA4097-2 may be impaired if the junction temperature exceeds  $175^\circ\text{C}$ . If the junction temperature exceeds  $175^\circ\text{C}$ , the ADA4097-1/ADA4097-2 has a final safety measure in the form of a thermal shutdown that shuts off the output stage and reduces the internal device currents. When this thermal shutdown function triggers, the output remains disabled in a high impedance state until the junction temperature drops  $20^\circ\text{C}$ . Persistent heavy loads and elevated ambient temperatures can cause the ADA4097-1/ADA4097-2 to oscillate in and out of thermal shutdown depending on the power dissipated on the die, until the heavy load is removed (see Figure 63).

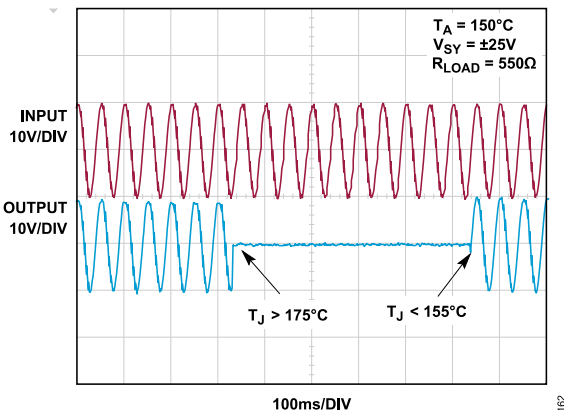

Figure 63. ADA4097-1/ADA4097-2 Cycling In and Out of Thermal Shutdown

It is not recommended to operate near the maximum junction temperature.

Typically,  $T_J$  can be estimated from  $T_A$  and the device power dissipation ( $P_D \times \theta_{JA}$ ), as shown in the following equation:

$$T_J = T_A + P_D \times \theta_{JA}$$

The power dissipation in the IC varies as a function of supply voltage, the output voltage, and load resistance. For a given supply voltage, the worst case power dissipation ( $P_{D(MAX)}$ ) in the IC occurs when the supply current is maximum, and the output voltage is at half of either supply voltage.

$$P_{D(MAX)} = V_S I_{S(MAX)} + \frac{\left(\frac{V_{SY}}{2}\right)^2}{R_{LOAD}}$$

For a given supply voltage, use Figure 64 as a guide for estimating the minimum load resistance that the ADA4097-1/ADA4097-2 can drive for a given supply voltage and a given rise in junction temperature ( $\Delta T_J$ ). For example, to limit  $\Delta T_J$  to  $50^\circ\text{C}$ , the load driven on

the  $\pm 15$  V supplies ( $+30$  V total supply) must not be lower than  $0.8$  k $\Omega$ . Note that it is assumed that  $\theta_{JA}$  is  $192^\circ\text{C}/\text{W}$  for the 6-lead TSOT package only.

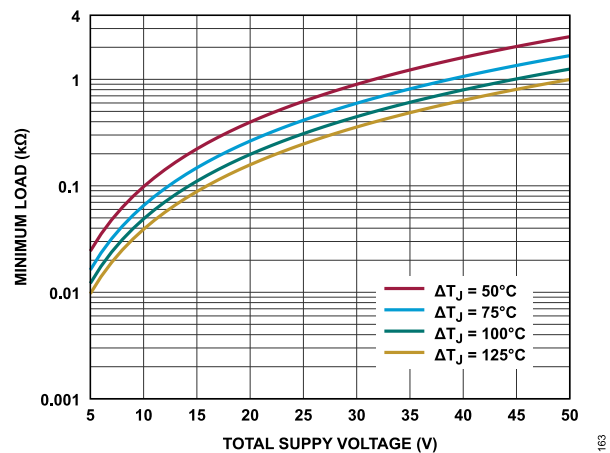

Figure 64. Minimum Load Resistance for Given  $\Delta T_J$  and  $V_{SY}$

## CIRCUIT LAYOUT CONSIDERATIONS

Careful and deliberate attention to detail when laying out the ADA4097-1/ADA4097-2 boards yields optimal performance. Power supply bypassing, parasitic capacitance, and component selection all contribute to the overall performance of the amplifier.

## POWER SUPPLY BYPASSING

On single supplies, solder the  $-V_S$  supply pin directly to a low impedance ground plane. Bypass the  $+V_S$  pin to a low impedance ground plane with a low effective series resistance (ESR) multilayer ceramic capacitor (MLCC) of  $0.1$   $\mu\text{F}$ , typically, as close to the  $\pm V_S$  supply pins as possible. When driving heavy loads, add  $10$   $\mu\text{F}$  of supply capacitance. When using split supplies, these conditions are applicable to the  $-V_S$  supply pin.

The ADA4097-1/ADA4097-2 have an internal current source of  $\sim 0.6$   $\mu\text{A}$  on the SHDN pin (ADA4097-1) and the SHDNx pins (ADA4097-2, the 10-lead LFCSP only) to pull the pins down to  $-V_S$  and to place the op amps in the default amplifying state. If the shutdown state is not required, hard tie the SHDN pin and the SHDNx pins to the  $-V_S$  pin. If the SHDN pin and the SHDNx pins are left floating or driven by a source with significant source impedance ( $>100$   $\Omega$ ), bypass the  $-V_S$  supply pin with a small,  $1$  nF capacitor to prevent stray signals from coupling on the SHDN pin and the SHDNx pins, which can inadvertently trigger shutdown.

## GROUNDING

Use ground and power planes where possible to reduce the resistance and inductance of the supply and ground returns. Place bypass capacitors as close as possible to the  $\pm V_S$  supply pins, with the other ends connected to the ground plane. It is recommended to use a bypass capacitor of at least  $0.1$   $\mu\text{F}$  when driving light loads (load currents  $< 100$   $\mu\text{A}$ ), and more capacitance when driving heavier loads. Routing from the output to the load and return to the

**APPLICATIONS INFORMATION**

ground plane must have minimal loop area to keep inductance to a minimum.

**ESD PROTECTION WHEN POWERED**

ICs react to ESD strikes differently when unpowered vs. powered, which falls under IEC-61000-4-2 standards (see the [Absolute Maximum Ratings](#) section). A device that performs well under HBM conditions can perform poorly under International Electrotechnical Commission (IEC) conditions. The ADA4097-1/ADA4097-2 are thoroughly abused with ESD strikes under IEC conditions to create a front-end circuit protection scheme that protects the devices if subjected to ESD strikes. [Figure 65](#) and [Figure 66](#) show two different protection schemes that extend the protection of the ADA4097-1/ADA4097-2 to ±8 kV ESD strikes.

Consider the following when selecting components:

- ▶ A component size of 0805 or larger to reduce chance of arc-over
- ▶ Pulse withstanding, thick film resistors
- ▶ COG MLCC with a minimum rating of 100 V
- ▶ Bidirectional, transient voltage suppression (TVS) diodes

In the circuit shown in [Figure 65](#), R1 is a 220 Ω, Panasonic, 0805, ERJ-P6 series, and C1 is a 100 pF, Yageo, 0805, 100 V, C0G/NPO.

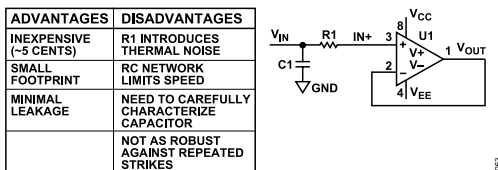

**Figure 65. ESD Protection Circuit (RC Network)**

In the circuit shown in [Figure 66](#), R1 is a 220 Ω, Panasonic, 0805, ERJ-P6 series, and D1 is a Bourns CDSOD323-T36SC. An ESD varistor can be considered for D1.

For more information on system level ESD considerations, see the technical article, [When Good Electrons Go Bad: How to Protect Your Analog Front End](#), on the Analog Devices, Inc., website.

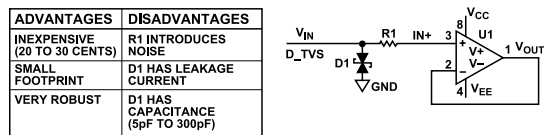

**Figure 66. ESD Protection Circuit (R-TVS Network)**

**RELATED PRODUCTS**

[Table 10](#) describes several alternative precision amplifiers that can also be considered for certain applications.

**Table 10. ADA4097-1/ADA4097-2 Related Products**

Model	V <sub>OS</sub> (μV)	I <sub>B</sub> (nA)	GBP (kHz)	e <sub>n</sub> (nV/√Hz)	I <sub>SY</sub> (μA)	Common-Mode Input Range (V)
<a href="#">ADA4097-1</a>	60	0.3	130	53	33	-V <sub>S</sub> to -V <sub>S</sub> + 70
<a href="#">ADA4097-2</a>	60	0.3	130	53	33	-V <sub>S</sub> to -V <sub>S</sub> + 70
<a href="#">ADA4098-1</a>	30	0.7	1000	17	165	-V <sub>S</sub> to -V <sub>S</sub> + 70
<a href="#">ADA4098-2</a>	30	0.7	1000	17	165	-V <sub>S</sub> to -V <sub>S</sub> + 70
<a href="#">ADA4099-1</a>	30	10	8000	7	1500	-V <sub>S</sub> to -V <sub>S</sub> + 70
<a href="#">ADA4099-2</a>	30	10	8000	7	1500	-V <sub>S</sub> to -V <sub>S</sub> + 70
<a href="#">ADA4077-1</a>	35	1	3900	7	500	-V <sub>S</sub> to +V <sub>S</sub>
<a href="#">LT6015</a>	50	5	3200	18	335	-V <sub>S</sub> to -V <sub>S</sub> + 76
<a href="#">LT6014</a>	60	0.4	1600	9.5	165	-V <sub>S</sub> to +V <sub>S</sub>
<a href="#">LT1494</a>	375	1	2.7	185	1.5	-V <sub>S</sub> to -V <sub>S</sub> + 36
<a href="#">LT1490A</a>	500	8	180	50	55	-V <sub>S</sub> to -V <sub>S</sub> + 44

APPLICATIONS INFORMATION

TYPICAL APPLICATIONS

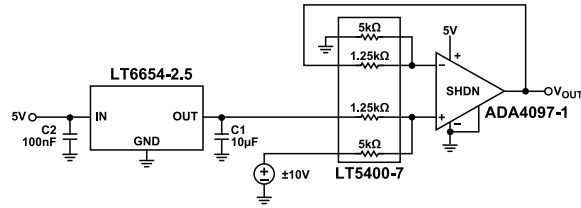

Figure 67. ±10 V to 0 V to +5 V Funnel Amplifier, High CMRR and ±80 V Input Protection via LT5400-7 Resistor Network

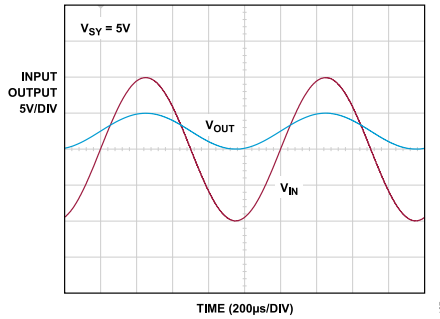

Figure 68. ±10 V to 0 V to +5 V Funnel Amplifier, Input and Output Voltages

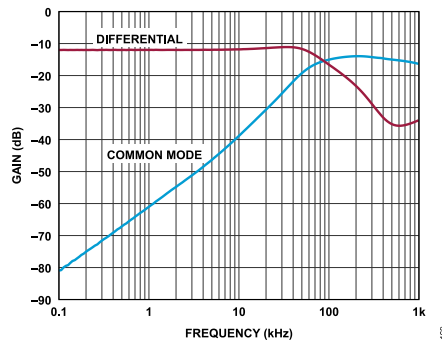

Figure 69. ±10 V to 0 V to +5 V Funnel Amplifier, System Gain

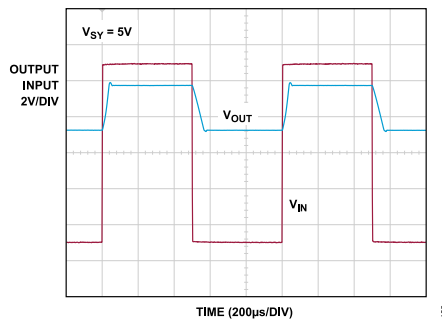

Figure 70. ±10 V to 0 V to +5 V Funnel Amplifier, Large Signal Pulse Response

APPLICATIONS INFORMATION

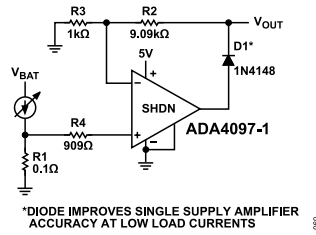

Figure 71.1 1 V/A Low-Side Current Sense

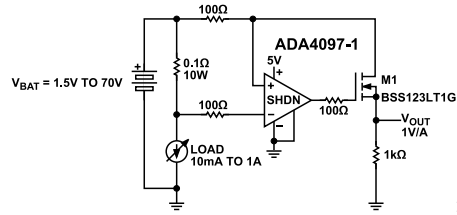

Figure 72.1 1 V/A High-Side Current Sense

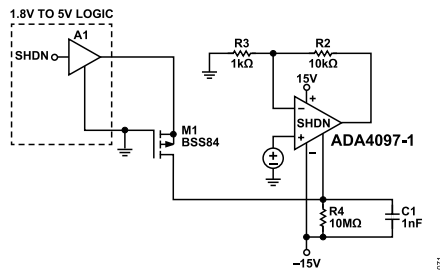
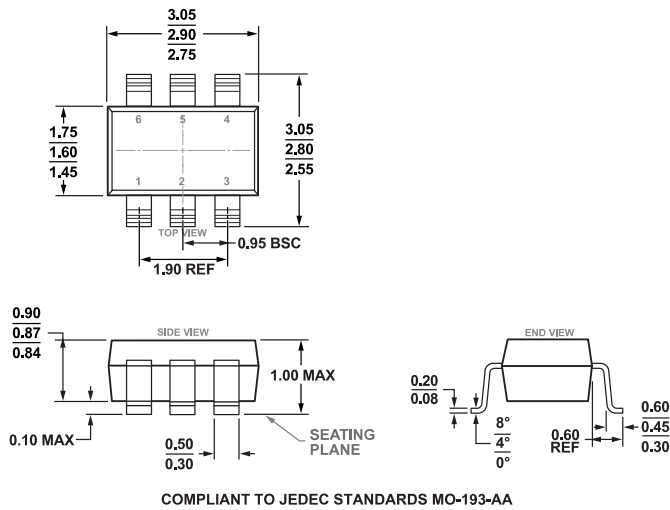
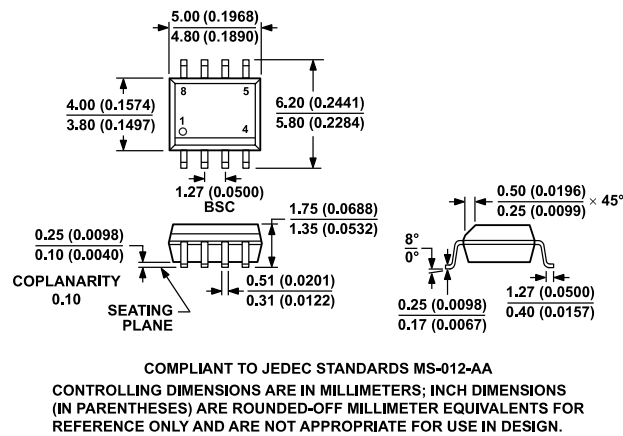

Figure 73. Microprocessor Control of SHDN Pin in Split Supply Applications

OUTLINE DIMENSIONS

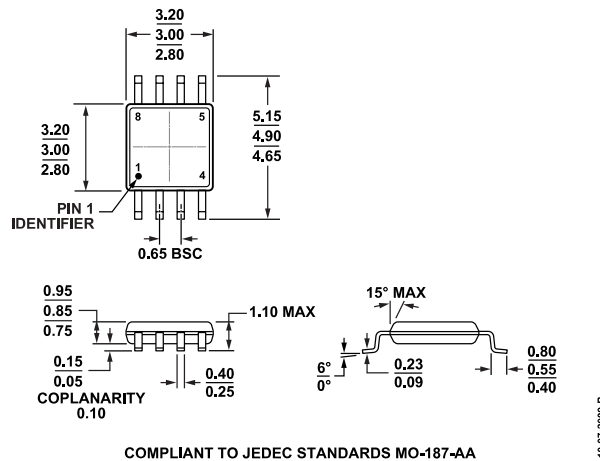

**Figure 74. 6-Lead Thin Small Outline Transistor Package [TSOT] (UJ-6)**  
 Dimensions shown in millimeters

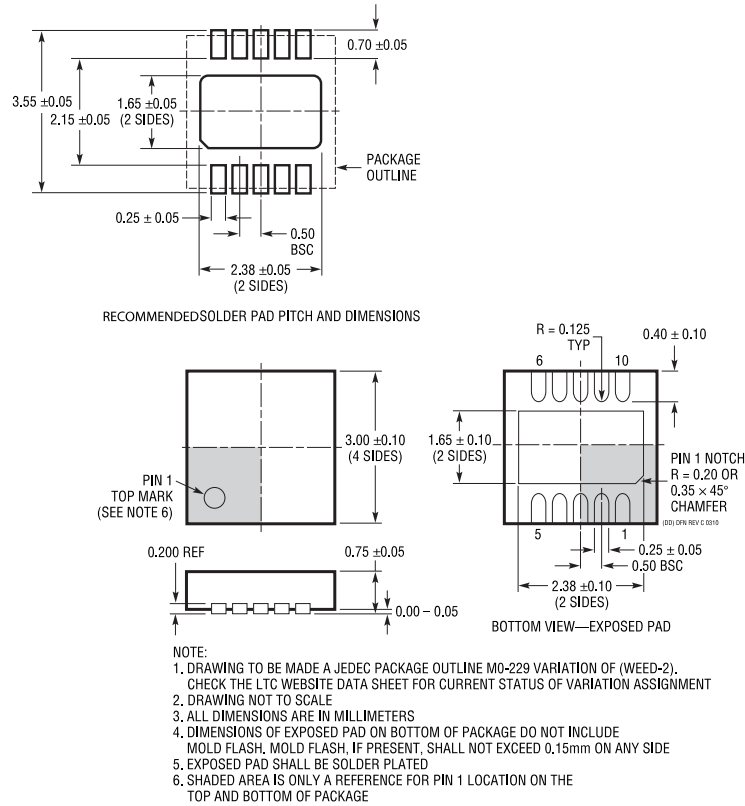

**Figure 75. 8-Lead Standard Small Outline Package [SOIC\_N] Narrow Body (R-8)**  
 Dimensions shown in millimeters and (inches)

OUTLINE DIMENSIONS



**Figure 76. 8-Lead Mini Small Outline Package [MSOP] (RM-8)**  
 Dimensions shown in millimeters



**Figure 77. 10-Lead Lead Frame Chip Scale Package [LFCSP] 3 mm x 3 mm Body and 0.75 mm Package Height (05-08-1699)**  
 Dimensions shown in millimeters

## OUTLINE DIMENSIONS

## ORDERING GUIDE

Model <sup>1</sup>	Temperature Range	Package Description	Packing Quantity	Package Option	Marking Code
ADA4097-1BUJZ-R5	-40°C to +125°C	6-Lead TSOT	Reel, 500	UJ-6	Y7K
ADA4097-1BUJZ-RL7	-40°C to +125°C	6-Lead TSOT	Reel, 2500	UJ-6	Y7K
ADA4097-1HUJZ-RL7	-55°C to +150°C	6-Lead TSOT	Reel, 2500	UJ-6	Y7L
ADA4097-2BCPZ	-40°C to +125°C	10-Lead LFCSP	Tube, 121	05-08-1699	A48
ADA4097-2BCPZ-RL7	-40°C to +125°C	10-Lead LFCSP	Reel, 2500	05-08-1699	A48
ADA4097-2BRMZ	-40°C to +125°C	8-Lead MSOP	Tube, 50	RM-8	A48
ADA4097-2BRMZ-RL7	-40°C to +125°C	8-Lead MSOP	Reel, 2500	RM-8	A48
ADA4097-2BRZ	-40°C to +125°C	8-Lead SOIC_N	Tube, 100	R-8	
ADA4097-2BRZ-RL7	-40°C to +125°C	8-Lead SOIC_N	Reel, 2500	R-8	
ADA4097-2HCPZ	-55°C to +150°C	10-Lead LFCSP	Tube, 121	05-08-1699	A49
ADA4097-2HCPZ-RL7	-55°C to +150°C	10-Lead LFCSP	Reel, 2500	05-08-1699	A49
ADA4097-2HRZ	-55°C to +150°C	8-Lead SOIC_N	Tube, 100	R-8	
ADA4097-2HRZ-RL7	v55°C to +150°C	8-Lead SOIC_N	Reel, 2500	R-8	

<sup>1</sup> Z = RoHS Compliant Part.

## EVALUATION BOARDS

Model <sup>1</sup>	Description
EVAL-ADA4097-1HUJZ	Evaluation Board, Single TSOT
EVAL-ADA4097-2EBZ	Evaluation Board, Dual LFCSP

<sup>1</sup> Z = RoHS Compliant Part.