

FEATURES

- Fast switching
- 100% avalanche tested
- Improved dv/dt capability

APPLICATIONS

- Switch Mode Power Supply (SMPS)
- Uninterruptible Power Supply (UPS)
- Power Factor Correction (PFC)

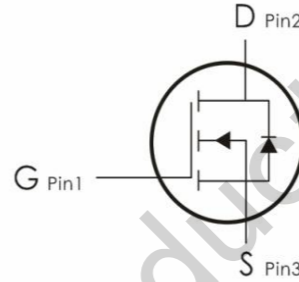
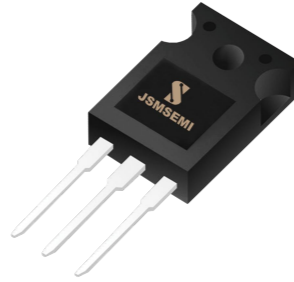

Device Marking and Package Information		
Device	Package	Marking
IXTQ96N20P	TO-247	IXTQ96N20P

Absolute Maximum Ratings $T_C = 25^\circ\text{C}$, unless otherwise noted			
Parameter	Symbol	Value	Unit
		TO-247	
Drain-Source Voltage ($V_{GS} = 0\text{V}$)	V_{DSS}	220	V
Continuous Drain Current $V_{GS} = 10\text{V}$ $T_C = 25^\circ\text{C}$	I_b	100	A
Pulsed Drain Current (note1)	I_{DM}	400	A
Gate-Source Voltage	V_{GSS}	± 20	V
Single Pulse Avalanche Energy (note2)	E_{AS}	1960.2	mJ
Avalanche Current (note1)	I_{AS}	19.8	A
Repetitive Avalanche Energy (note1)	E_{AR}	1176.1	mJ
Power Dissipation ($T_C = 25^\circ\text{C}$)	P_D	700	W
Peak Diode Recovery dv/dt (note1)	dv/dt	5.0	
Operating Junction and Storage Temperature Range	T_J, T_{stg}	-55~+150	$^\circ\text{C}$

Thermal Resistance			
Parameter	Symbol	Value	Unit
Thermal Resistance, Junction-to-Case	R_{thJC}	0.89	$^\circ\text{C/W}$
Thermal Resistance, Junction-to-Ambient	R_{thJA}	60	

Specifications $T_J = 25^\circ\text{C}$, unless otherwise noted						
Parameter	Symbol	Test Conditions	Value			Unit
			Min.	Typ.	Max.	
Static						
Drain-Source Breakdown Voltage	$V_{(BR)DSS}$	$V_{GS} = 0V, I_D = 250\mu A$	220	--	--	V
Zero Gate Voltage Drain Current	I_{DSS}	$V_{DS} = 40V, V_{GS} = 0V, T_J = 25^\circ\text{C}$	--	--	1	μA
		$V_{DS} = 32V, V_{GS} = 0V, T_J = 125^\circ\text{C}$	--	--	100	
Gate-Source Leakage	I_{GSS}	$V_{GS} = \pm 20V$	--	--	± 100	nA
Gate-Source Threshold Voltage	$V_{GS(th)}$	$V_{DS} = V_{GS}, I_D = 250\mu A$	2.0	--	4.0	V
Drain-Source On-Resistance (Note3)	$R_{DS(on)}$	$V_{GS} = 10V, I_D = 95A(\text{Note4})$	--	25	30	m Ω
Dynamic						
Input Capacitance	C_{iss}	$V_{GS} = 0V,$ $V_{DS} = 25V,$ $f = 1.0\text{MHz}$	--	5784	--	pF
Output Capacitance	C_{oss}		--	893	--	
Reverse Transfer Capacitance	C_{rss}		--	561	--	
Total Gate Charge	Q_g	$V_{DD} = 20V, I_D = 190A,$ $V_{GS} = 10V(\text{Note4})$	--	367	--	nC
Gate-Source Charge	Q_{gs}		--	33.8	--	
Gate-Drain Charge	Q_{gd}		--	177	--	
Turn-on Delay Time	$t_{d(on)}$	$V_{DD} = 20V, I_D = 190A,$ $R_G = 10\Omega, V_{GS} = 10V$ (Note4)	--	55	--	ns
Turn-on Rise Time	t_r		--	165	--	
Turn-off Delay Time	$t_{d(off)}$		--	1050	--	
Turn-off Fall Time	t_f		--	367	--	
Drain-Source Body Diode Characteristics						
Continuous Body Diode Current	I_S	$T_C = 25^\circ\text{C}$	--	--	100	A
Pulsed Diode Forward Current	I_{SM}		--	--	400	
Body Diode Voltage	V_{SD}	$T_J = 25^\circ\text{C}, I_{SD} = 95A, V_{GS} = 0V$	--	--	1.4	V
Reverse Recovery Time	t_{rr}	$V_{GS} = 0V, I_S = 190A,$ $di_F/dt = 100A/\mu s$	--	360	--	ns
Reverse Recovery Charge	Q_{rr}		--	5.61	--	μC

Notes

1. Repetitive Rating: Pulse width limited by maximum junction temperature
2. $L = 10\text{mH}, V_{DD} = 50V, R_G = 25\Omega$, Starting $T_J = 25^\circ\text{C}$
3. Pulse Test: Pulse width $\leq 300\mu s$, Duty Cycle $\leq 1\%$

Typical Characteristics $T_J = 25^\circ\text{C}$, unless otherwise noted

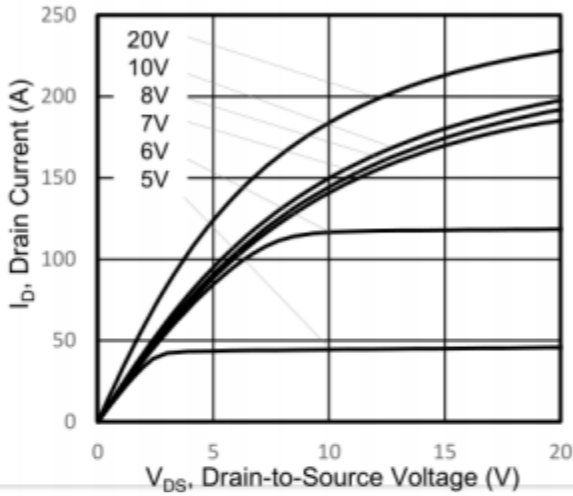
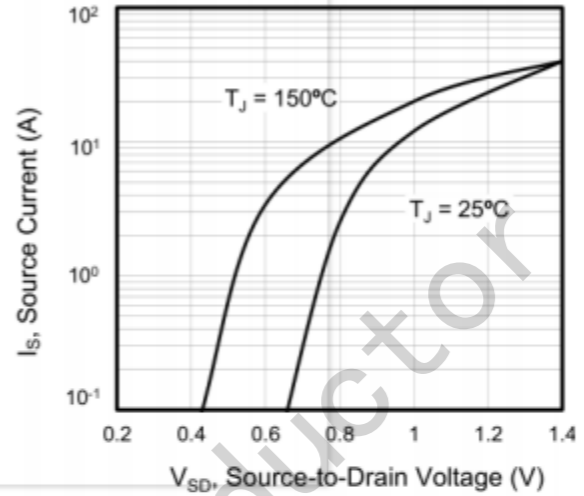
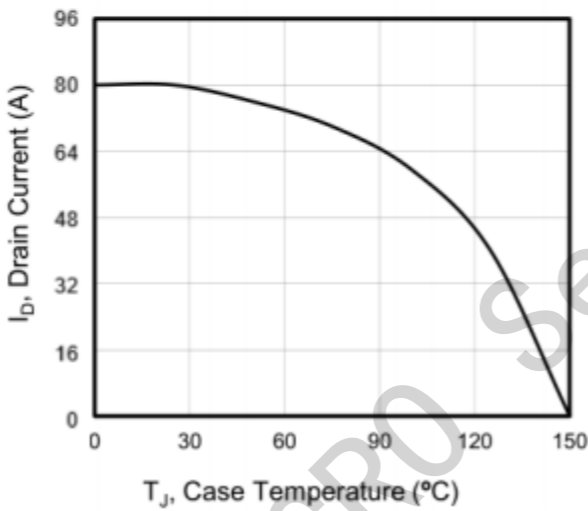
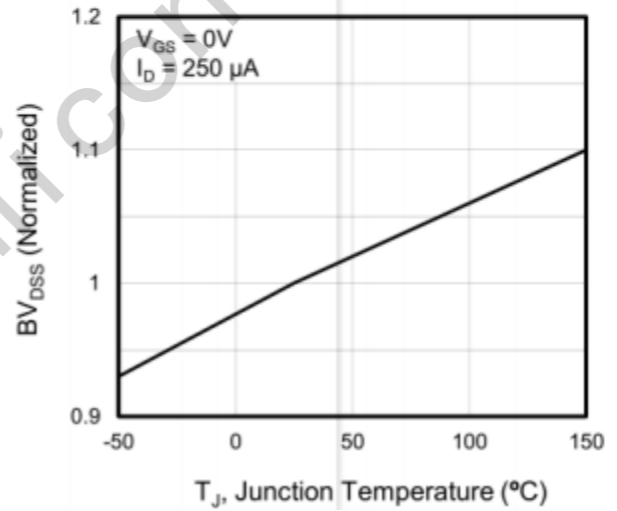
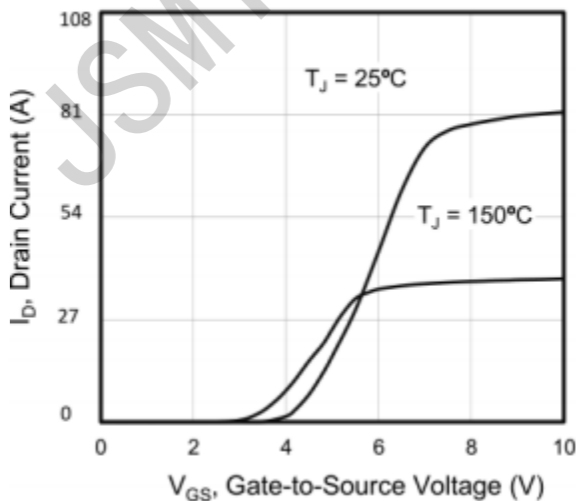
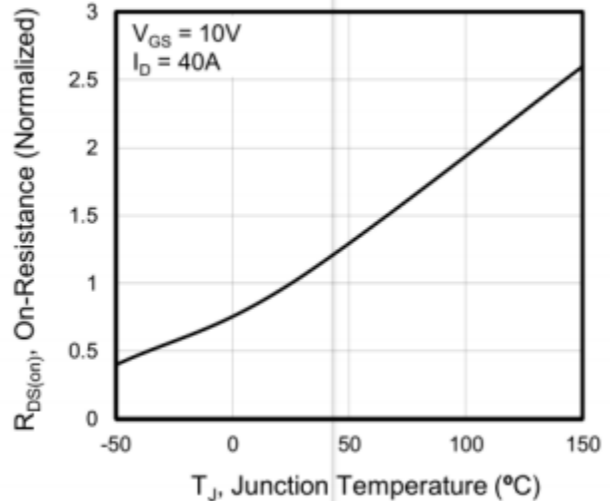
Figure 1. Output Characteristics ($T_J = 25^\circ\text{C}$)

Figure 2. Body Diode Forward Voltage

Figure 3. Drain Current vs. Temperature

Figure 4. BV_{DSS} Variation vs. Temperature

Figure 5. Transfer Characteristics

Figure 6. On-Resistance vs. Temperature

Typical Characteristics $T_J = 25^\circ\text{C}$, unless otherwise noted

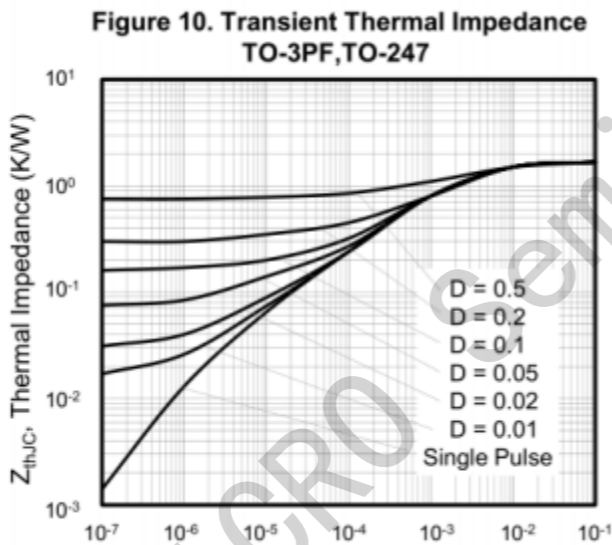
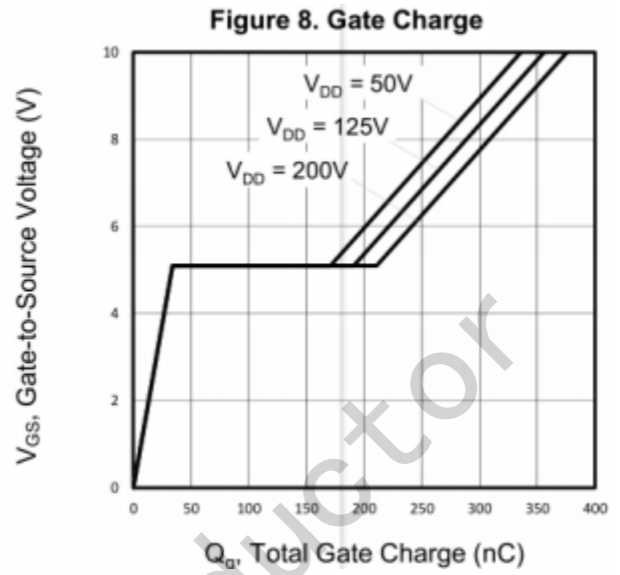
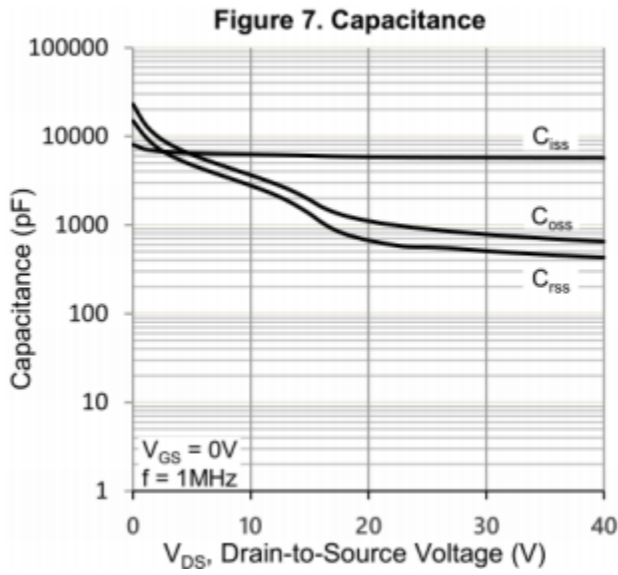

Figure A: Gate Charge Test Circuit and Waveform

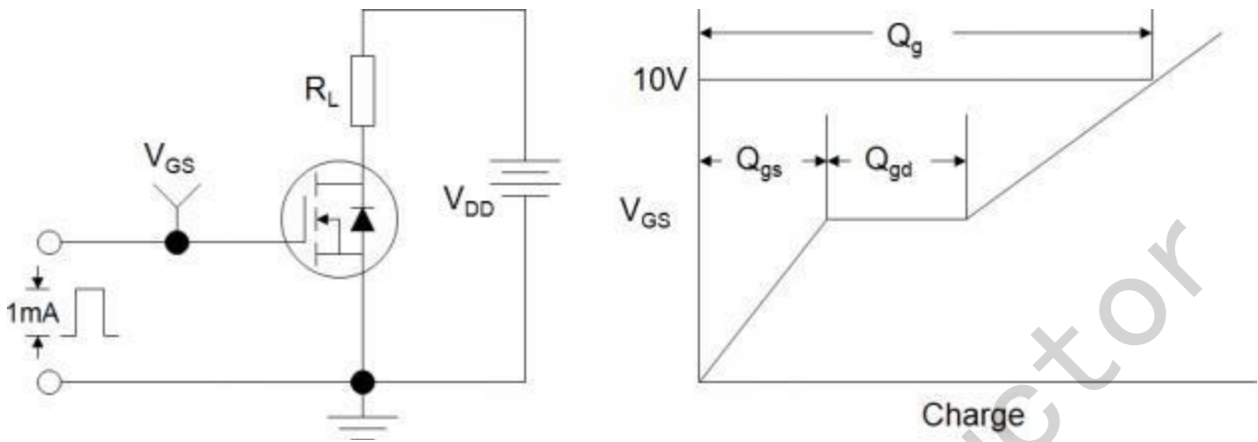

Figure B : Resistive Switching Test Circuit and Waveform

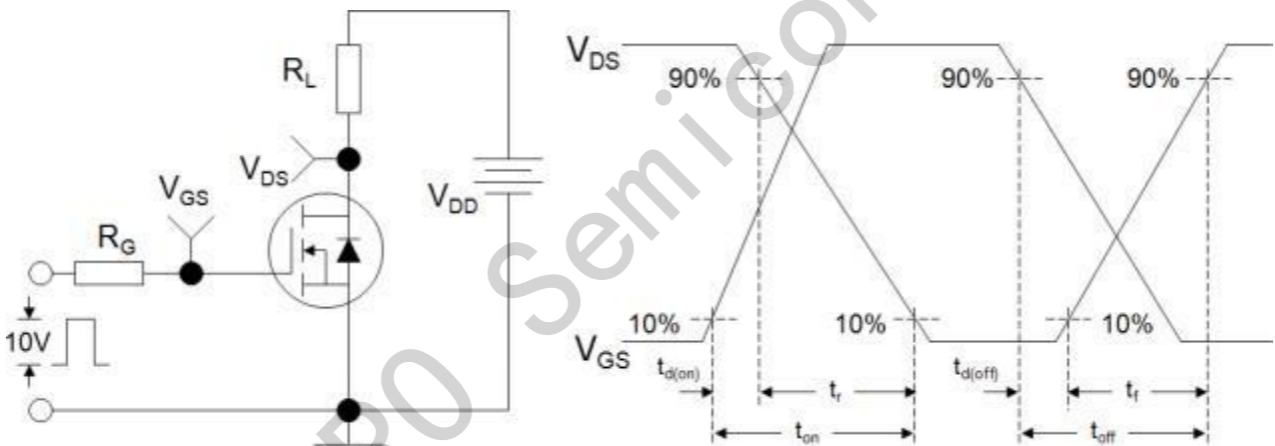
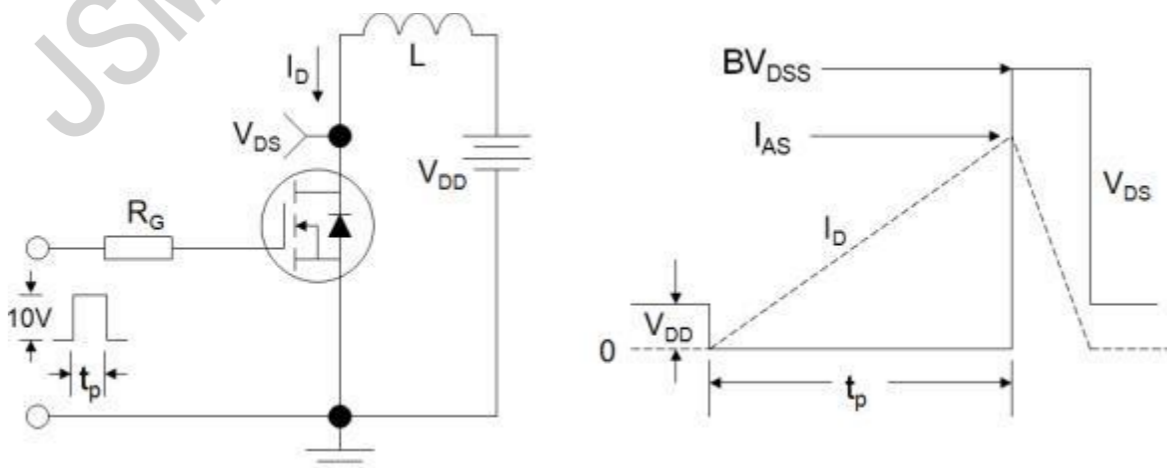
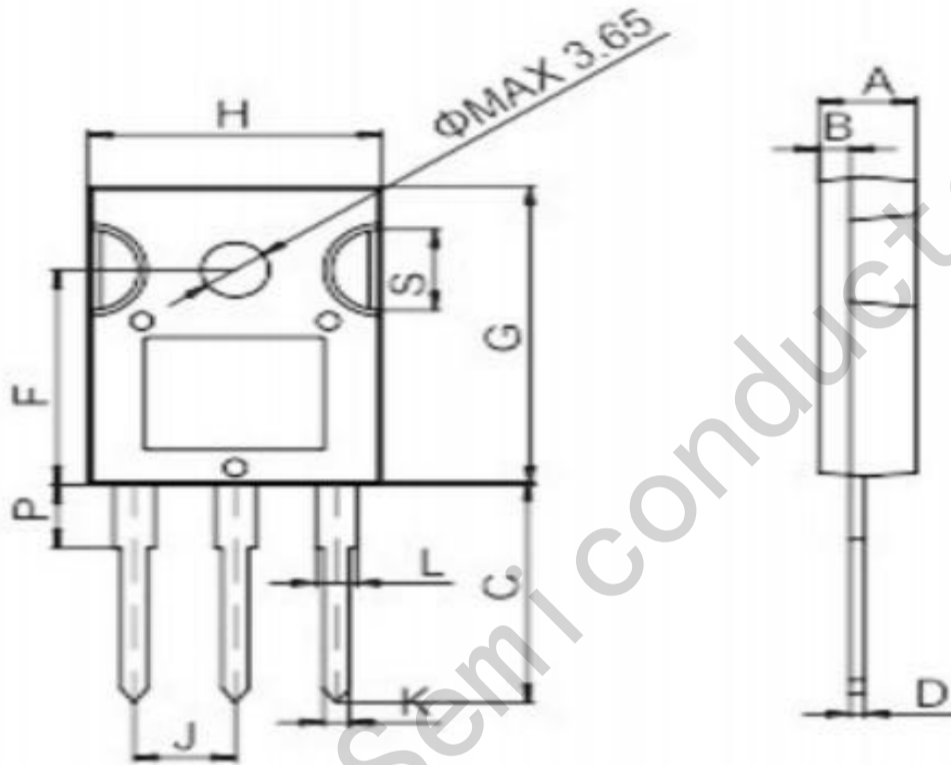

Figure C : Unclamped Inductive Switching Test Circuit and Waveform



TO-247



Ref.	Dimensions					
	Millimeters			Inches		
	Min.	Typ.	Max.	Min.	Typ.	Max.
A	4.9		5.4	0.193		0.213
B	1.6		2.0	0.063		0.079
C	14.35		15.4	0.565		0.606
D	0.5		0.8	0.020		0.031
F	14.4		15.1	0.567		0.594
G	19.7		20.6	0.775		0.811
H	15.4		16.2	0.606		0.638
J	5.3		5.6	0.209		0.220
K	1.3		1.5	0.051		0.059
L	2.8		3.3	0.110		0.130
P	3.7		4.2	0.146		0.165
S	5.35		5.65	0.211		0.222