

**PLASTIC-ENCAPSULATE VOLTAGE REGULATORS**

**FEATURES**

- Maximum Output Current  $I_o$ : 0.5 A
- Output Voltage  $V_o$ : 5 V
- Continuous Total Dissipation  
 $P_D$ : 1.25 W ( $T_a = 25\text{ }^\circ\text{C}$ )
- Surface Mount device

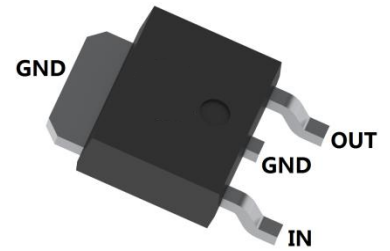

**SCHEMATIC DIAGRAM**

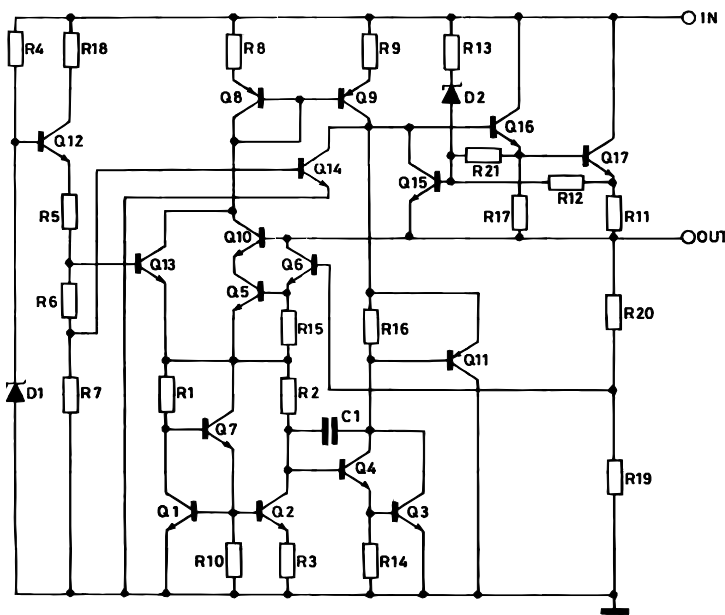

**TO-252**

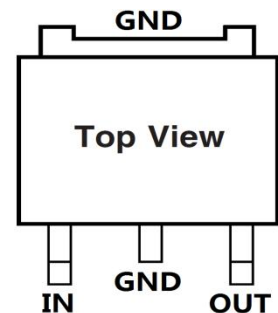

**MECHANICAL DATA**

- Case: TO-252
- Case Material: Molded Plastic. UL flammability
- Classification Rating: 94V-0
- Weight: 0.055 grams (approximate)

**MAXIMUM RATINGS (Operating temperature range applies unless otherwise specified)**

Parameter	Symbol	Value	Unit
Input Voltage	$V_i$	35	V
Power Dissipation	$P_D$	1250	mW
Thermal Resistance from Junction to Ambient	$R_{\theta JA}$	80	$^\circ\text{C}/\text{W}$
Operating Temperature	$T_{opr}$	-25~+125	$^\circ\text{C}$
Storage Temperature Range	$T_{STG}$	-65 ~+150	$^\circ\text{C}$

**PLASTIC-ENCAPSULATE VOLTAGE REGULATORS**
**ELECTRICAL CHARACTERISTICS AT SPECIFIED VIRTUAL JUNCTION TEMPERATURE  
( $V_i=10V, I_o=350mA, C_i=0.33\mu F, C_o=0.1\mu F$ , unless otherwise specified )**

Parameter	Symbol	Min	Typ	Max	Unit	Conditions
Output voltage	$V_o$	4.80	5.0	5.20	V	$T_J=+25^\circ C$
		4.75	5.0	5.25	V	$7V \leq V_i \leq 20V, I_o=5mA \sim 350mA, -25^\circ C \leq T_J \leq +125^\circ C$
Load Regulation	$\Delta V_o$		15	100	mV	$I_o=5mA \sim 500mA, T_J=+25^\circ C$
			5	50	mV	$I_o=5mA \sim 200mA, T_J=+25^\circ C$
Line regulation	$\Delta V_o$		3	100	mV	$7V \leq V_i \leq 25V, I_o=200mA, T_J=+25^\circ C$
			1	50	mV	$8V \leq V_i \leq 25V, I_o=200mA, T_J=+25^\circ C$
Quiescent Current	$I_q$		4.2	6	mA	$T_J=+25^\circ C$
Quiescent Current Change	$\Delta I_q$			0.8	mA	$8V \leq V_i \leq 25V, -25^\circ C \leq T_J \leq +125^\circ C$
				0.5	mA	$5mA \leq I_o \leq 350mA, -25^\circ C \leq T_J \leq +125^\circ C$
Output Noise Voltage	$V_N$		42		$\mu V/V_o$	$10Hz \leq f \leq 100kHz, T_J=+25^\circ C$
Ripple Rejection	RR	62	80		dB	$8V \leq V_i \leq 18V, f=120Hz, I_o=300mA, -25^\circ C \leq T_J \leq +125^\circ C$
Dropout Voltage	$V_d$		2	2.5	V	$I_o=350mA, T_J=+25^\circ C$
Short Circuit Current	$I_{sc}$		300		mA	$V_i=10V, T_J=+25^\circ C$
Peak Current	$I_{pk}$		0.5		A	$T_J=+25^\circ C$

\*Pulse Test

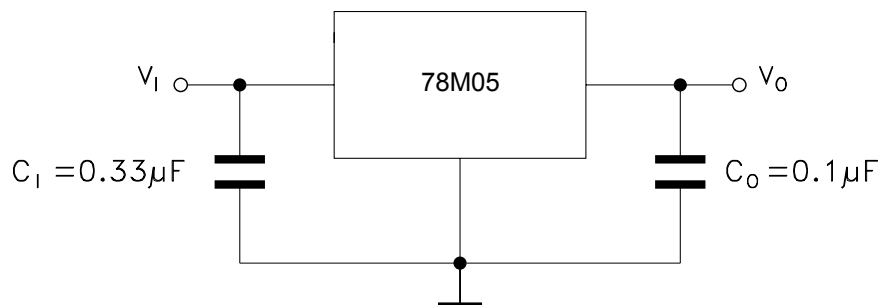
**TYPICAL APPLICATION**

Note: Bypass capacitors are recommended for optimum stability and transient response and should be located as close as Possible to the regulators.

PLASTIC-ENCAPSULATE VOLTAGE REGULATORS

Typical Characteristics

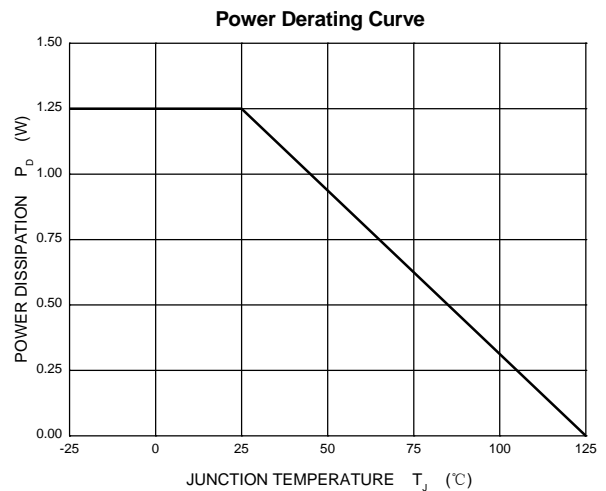
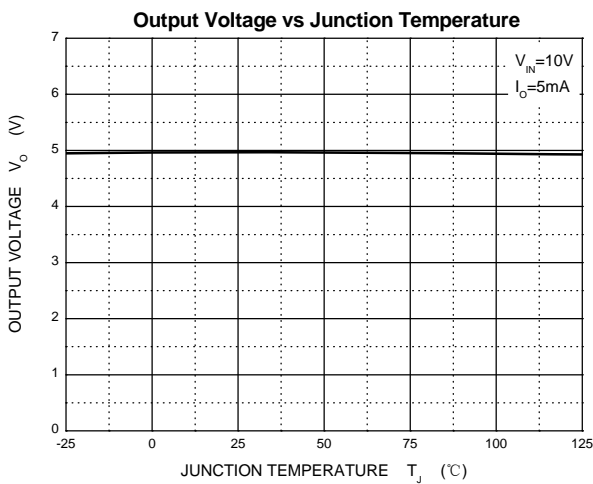
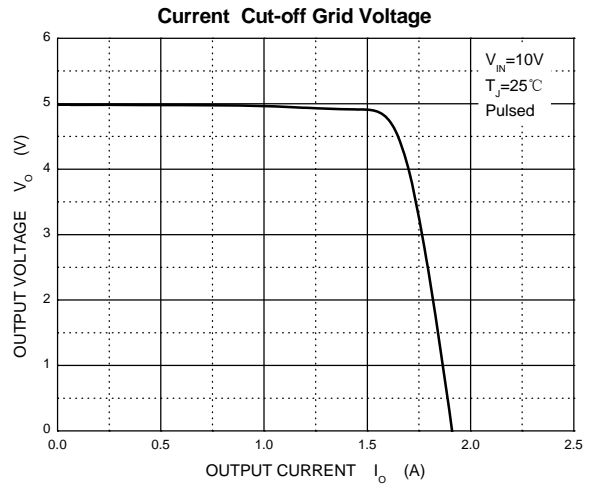
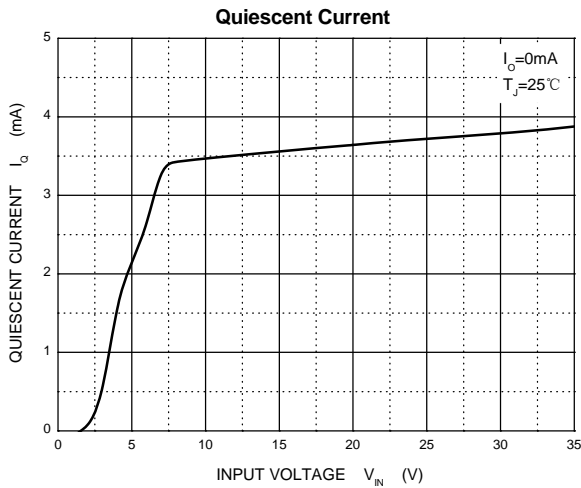
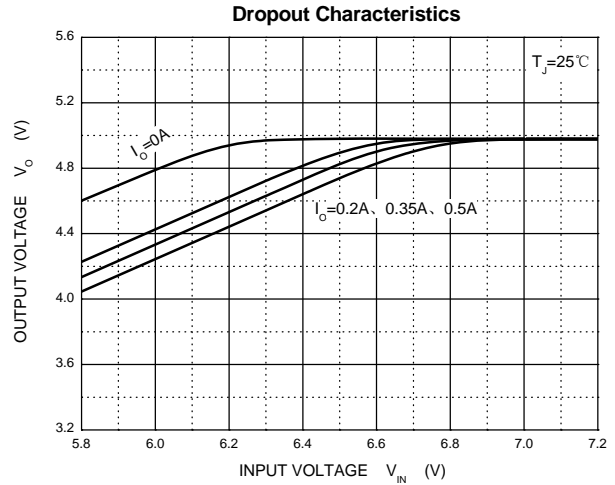
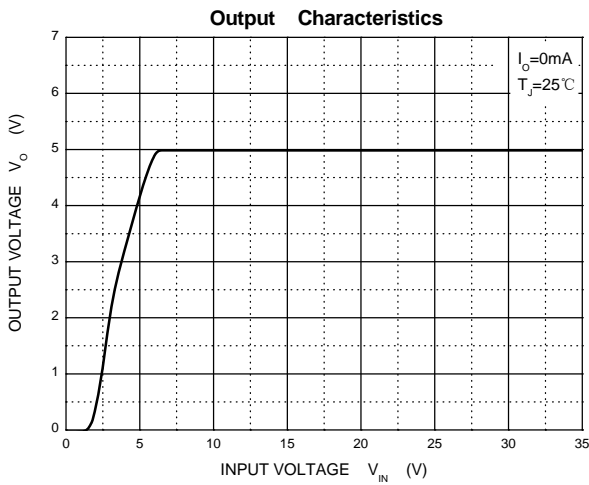

**PLASTIC-ENCAPSULATE VOLTAGE REGULATORS**

**TO-252 Package Outline Dimensions**

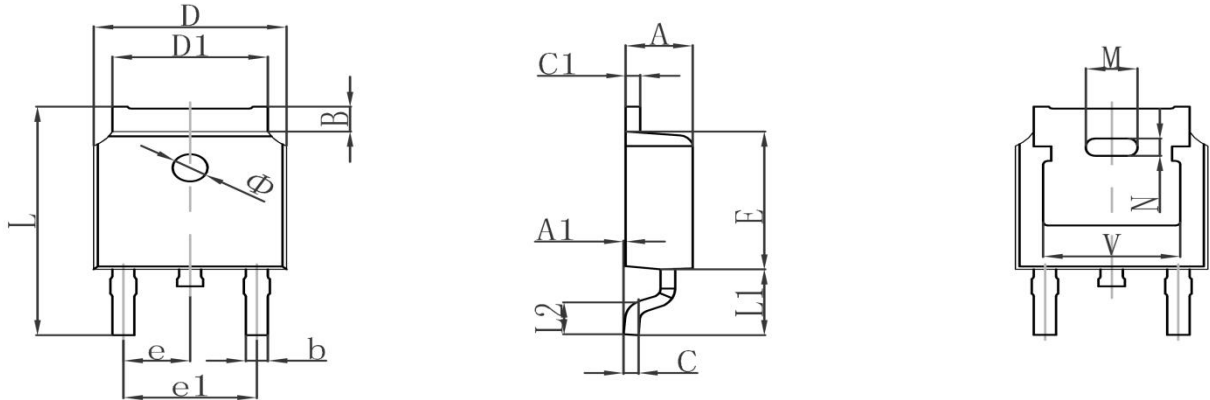

Symbol	Dimensions In Millimeters		Dimensions In Inches	
	Min.	Max.	Min.	Max.
A	2.200	2.380	0.087	0.094
A1	0.000	0.100	0.000	0.004
B	0.800	1.400	0.031	0.055
b	0.710	0.810	0.028	0.032
c	0.460	0.560	0.018	0.022
c1	0.460	0.560	0.018	0.022
D	6.500	6.700	0.256	0.264
D1	5.130	5.460	0.202	0.215
E	6.000	6.200	0.236	0.244
e	2.286TYP		0.090TYP	
e1	4.327	4.727	0.170	0.186
M	1.778REF		0.070REF	
N	0.762REF		0.018REF	
L	9.800	10.400	0.386	0.409
L1	2.9REF		0.114REF	
L2	1.400	1.700	0.055	0.067
V	4.830REF		0.190REF	
Φ	1.100	1.300	0.043	0.051

**TO-252 Suggested Pad Layout**

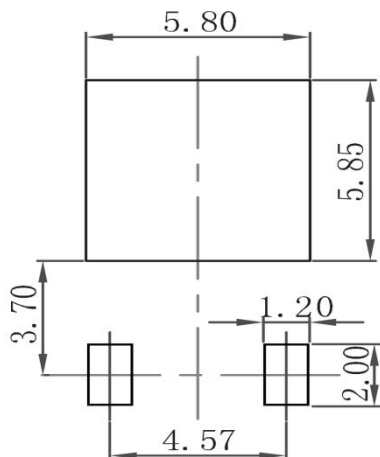

**Note:**

1. Controlling dimension: in millimeters
2. General tolerance: ±0.05mm
3. The pad layout is for reference purposes only

**PLASTIC-ENCAPSULATE VOLTAGE REGULATORS**

**TO-252 Tape and Reel**

**TO-252 Embossed Carrier Tape**

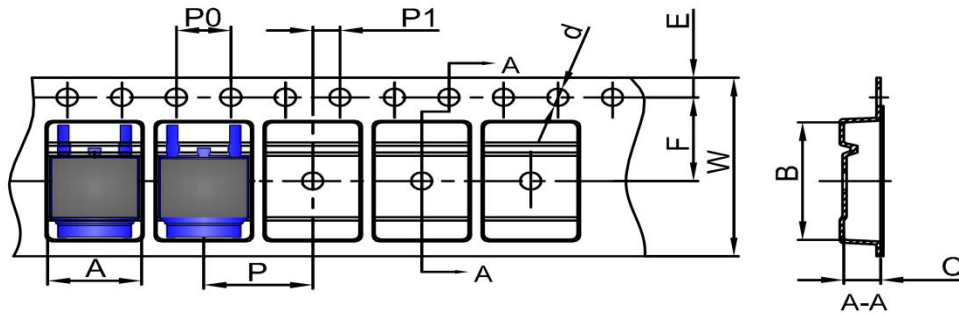

DIMENSIONS ARE IN MILLIMETER										
TYPE	A	B	C	d	E	F	P0	P	P1	W
TO-252	6.90	10.50	2.70	Ø1.55	1.75	7.50	4.00	8.00	2.00	16.00
TOLERANCE	±0.1	±0.1	±0.1	±0.1	±0.1	±0.1	±0.1	±0.1	±0.1	±0.1

**TO-252 Tape Leader and Trailer**

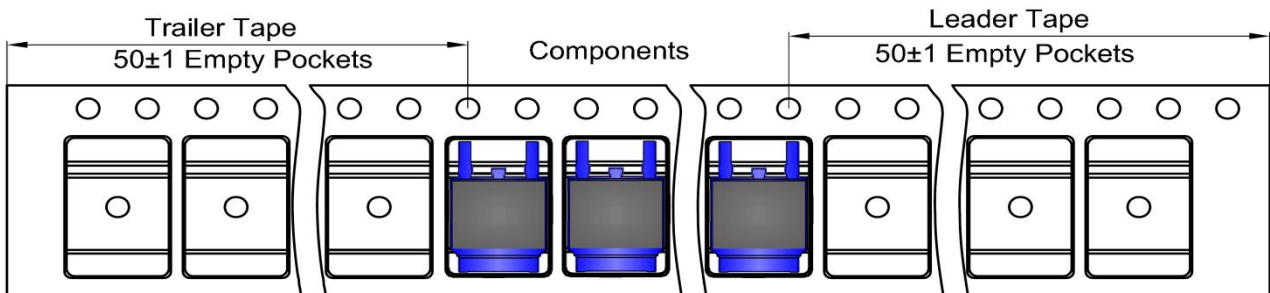

**TO-252 Reel**

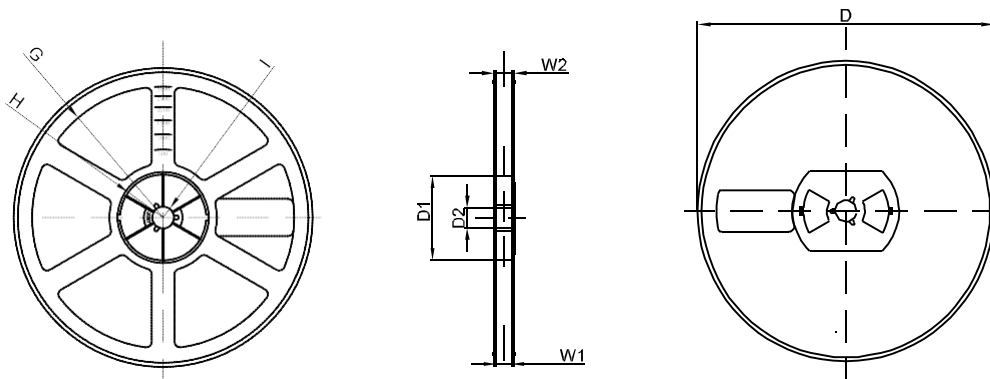

DIMENSIONS ARE IN MILLIMETER								
REEL OPTION	D	D1	D2	G	H	I	W1	W2
13" DIA	Ø330.00	100.00	Φ21.00	R151.00	R56.00	R6.50	16.40	21.00
TOLERANCE	±2	±1	±1	±1	±1	±1	±1	±1