

Description

The UMW PC357 series combine an AlGaAs infrared emitting diode as the emitter which is optically coupled to a silicon planar phototransistor detector in a plastic SOP4 package.

With the robust coplanar double mold structure, UMW PC357 series provide the most stable isolation feature.

Features

- High isolation 3750 VRMS
- CTR flexibility available see order information
- DC input with transistor output
- Operating temperature range - 55 °C to 110 °C
- REACH compliance
- Halogen free
- MSL class 1
- UL Recognized: UL1577, File No. E492440

Applications

- Switch mode power supplies
- Programmable controllers
- Household appliances
- Office equipment

Structural schematic diagram

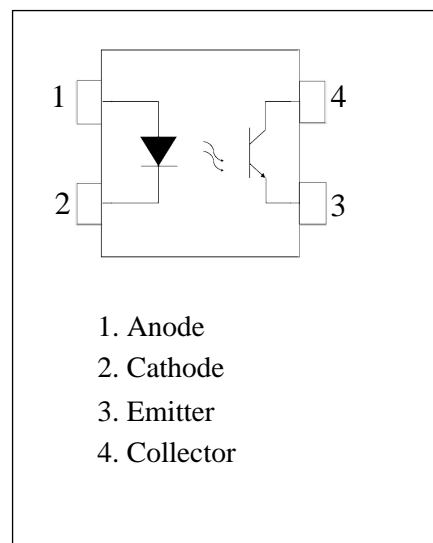

ABSOLUTE MAXIMUM RATINGS

PARAMETER	SYMBOL	VALUE	UNIT	NOTE
INPUT				
Forward Current	I_F	60	mA	
Peak Forward Current	I_{FP}	1	A	1
Reverse Voltage	V_R	6	V	
Input Power Dissipation	P_I	100	mW	
OUTPUT				
Collector - Emitter Voltage	V_{CEO}	35	V	
Emitter - Collector Voltage	V_{ECO}	7	V	
Collector Current	I_C	50	mA	
Output Power Dissipation	P_O	150	mW	
COMMON				
Total Power Dissipation	P_{tot}	200	mW	
Isolation Voltage	V_{iso}	3750	Vrms	2
Operating Temperature	T_{opr}	-55~110	°C	
Storage Temperature	T_{stg}	-55~125	°C	
Soldering Temperature	T_{sol}	260	°C	

 Note 1. 100 μ s pulse, 100Hz frequency

Note 2. AC For 1 Minute, R.H. = 40 ~ 60%

ELECTRICAL OPTICAL CHARACTERISTICS at Ta=25°C

PARAMETER	SYMBOL	MIN	TYP.	MAX.	UNIT	TEST CONDITION	NOTE
INPUT							
Forward Voltage	V _F	-	1.24	1.4	V	IF=10mA	
Reverse Current	I _R	-	-	10	μA	VR=6V	
Input Capacitance	C _{in}	-	10	-	pF	V=0, f=1kHz	
OUTPUT							
Collector Dark Current	I _{CEO}	-	-	100	nA	VCE=20V, IF=0	
Collector-Emitter Breakdown Voltage	BV _{CEO}	35	-	-	V	IC=0.1mA, IF=0	
Emitter-Collector Breakdown Voltage	BV _{ECO}	7	-	-	V	IE=0.1mA, IF=0	
TRANSFER CHARACTERISTICS							
Current Transfer Ratio	PC357	CTR	50	-	600	%	IF=5mA, VCE=5V
	PC357A		80	-	160		
	PC357B		130	-	260		
	PC357C		200	-	400		
Collector-Emitter Saturation Voltage	V _{CE(sat)}	-	0.06	0.2	V	IF=20mA, IC=1mA	
Isolation Resistance	R _{ISO}	10 ¹²	10 ¹⁴	-	Ω	DC500V, 40 ~ 60% R.H.	
Floating Capacitance	C _{IO}	-	0.4	1	pF	V=0, f=1MHz	
Cut-off Frequency	f _c	-	80	-	kHz	VCE=2V, IC=2mA RL=100Ω, -3dB	4
Response Time (Rise)	t _r	-	3	18	μs	VCE=2V, IC=2mA	3
Response Time (Fall)	t _f	-	4	18	μs	RL=100Ω	3

Note 3. Fig.12&13

Note 4. Fig.14

CHARACTERISTIC CURVES

Fig.1 Forward Current vs. Ambient Temperature

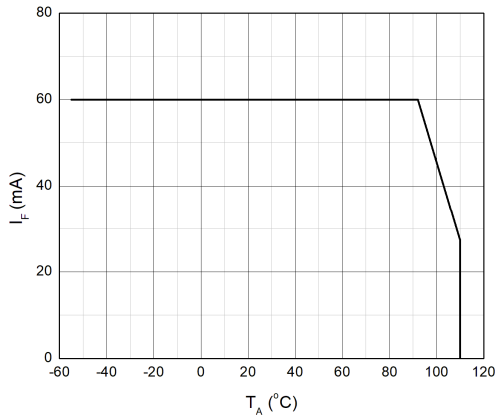

Fig.2 Collector Power Dissipation vs. Ambient Temperature

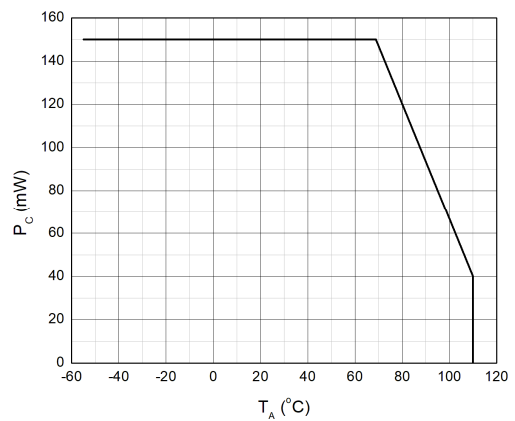

Fig.3 Forward Current vs. Forward Voltage

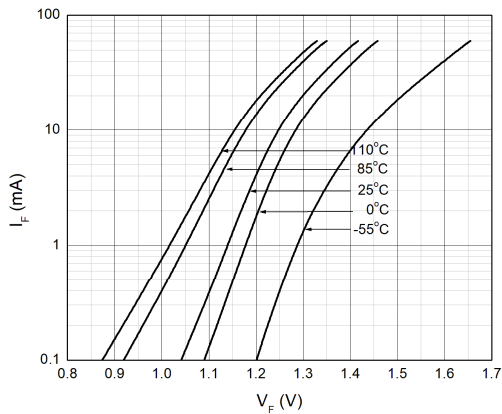

Fig.4 Collector Dark Current vs. Ambient Temperature

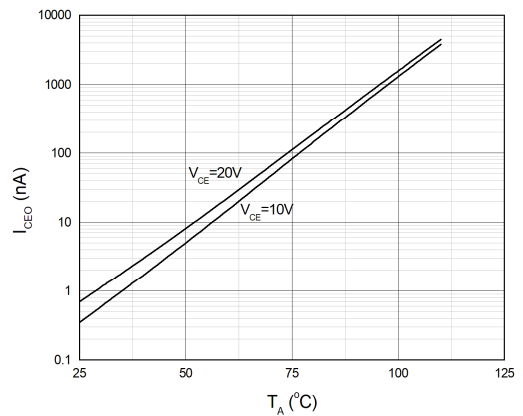

Fig.5 Collector Current vs. Collector-emitter Voltage

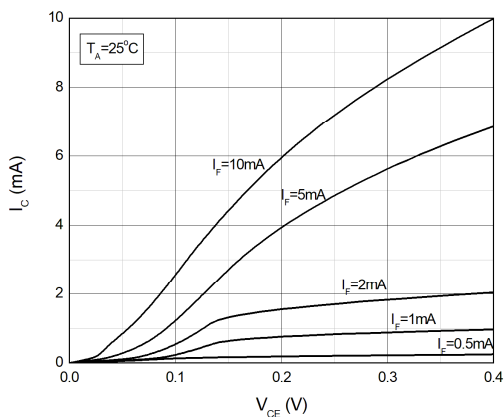
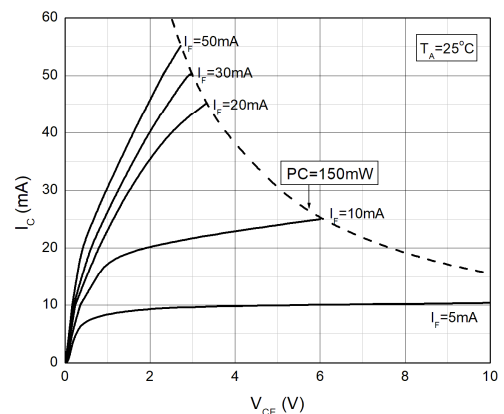

Fig.6 Collector Current vs. Collector-emitter Voltage



CHARACTERISTIC CURVES

Fig.7 Normalized Current Transfer Ratio vs. Forward Current

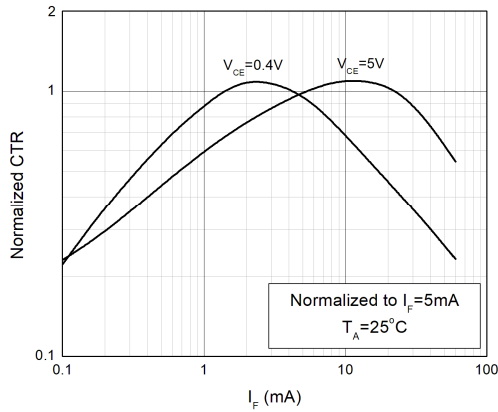

Fig.8 Normalized Current Transfer Ratio vs. Ambient Temperature

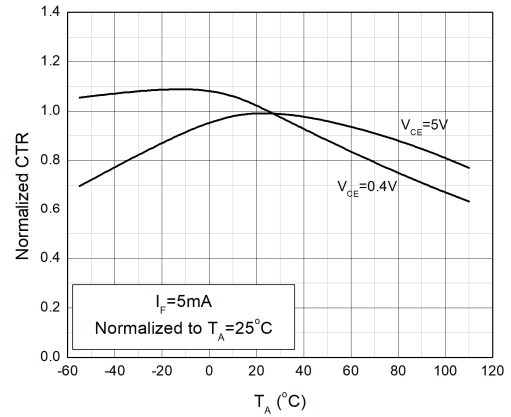

Fig.9 Collector-emitter Saturation Voltage vs. Ambient Temperature

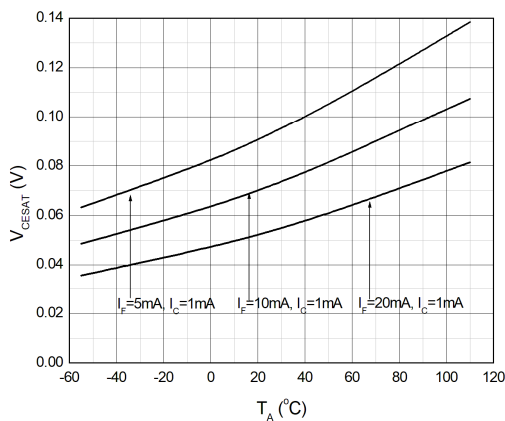

Fig.10 Switching Time vs. Load Resistance

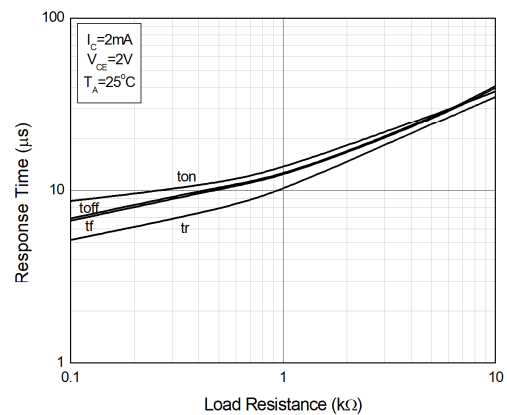
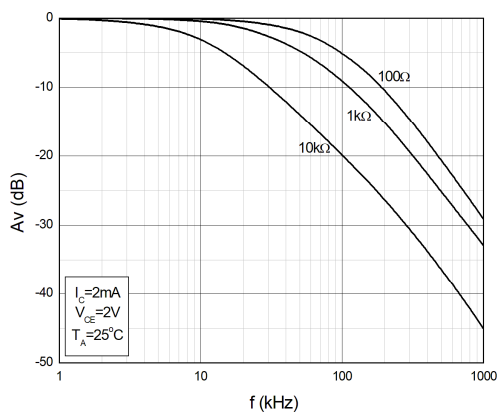

Fig.11 Frequency Response



TEST CIRCUITS

Fig.12 Test Circuits of Response Time

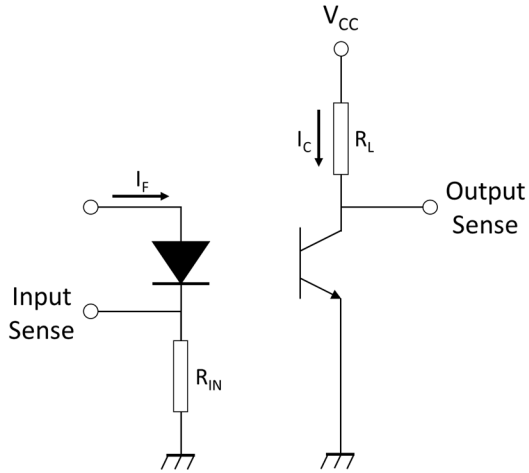

Fig.13 Curves of Response Time

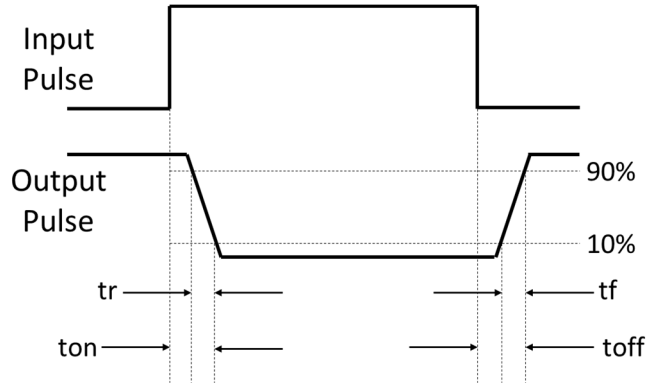
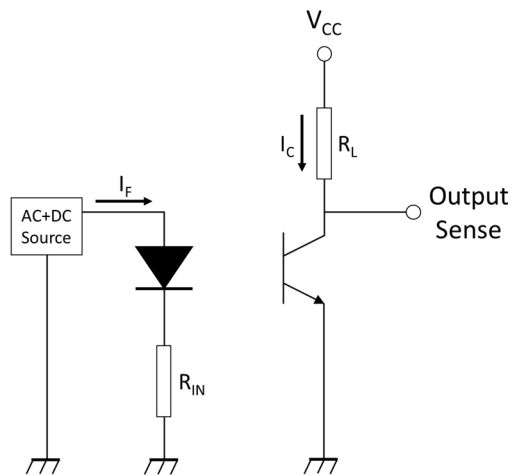
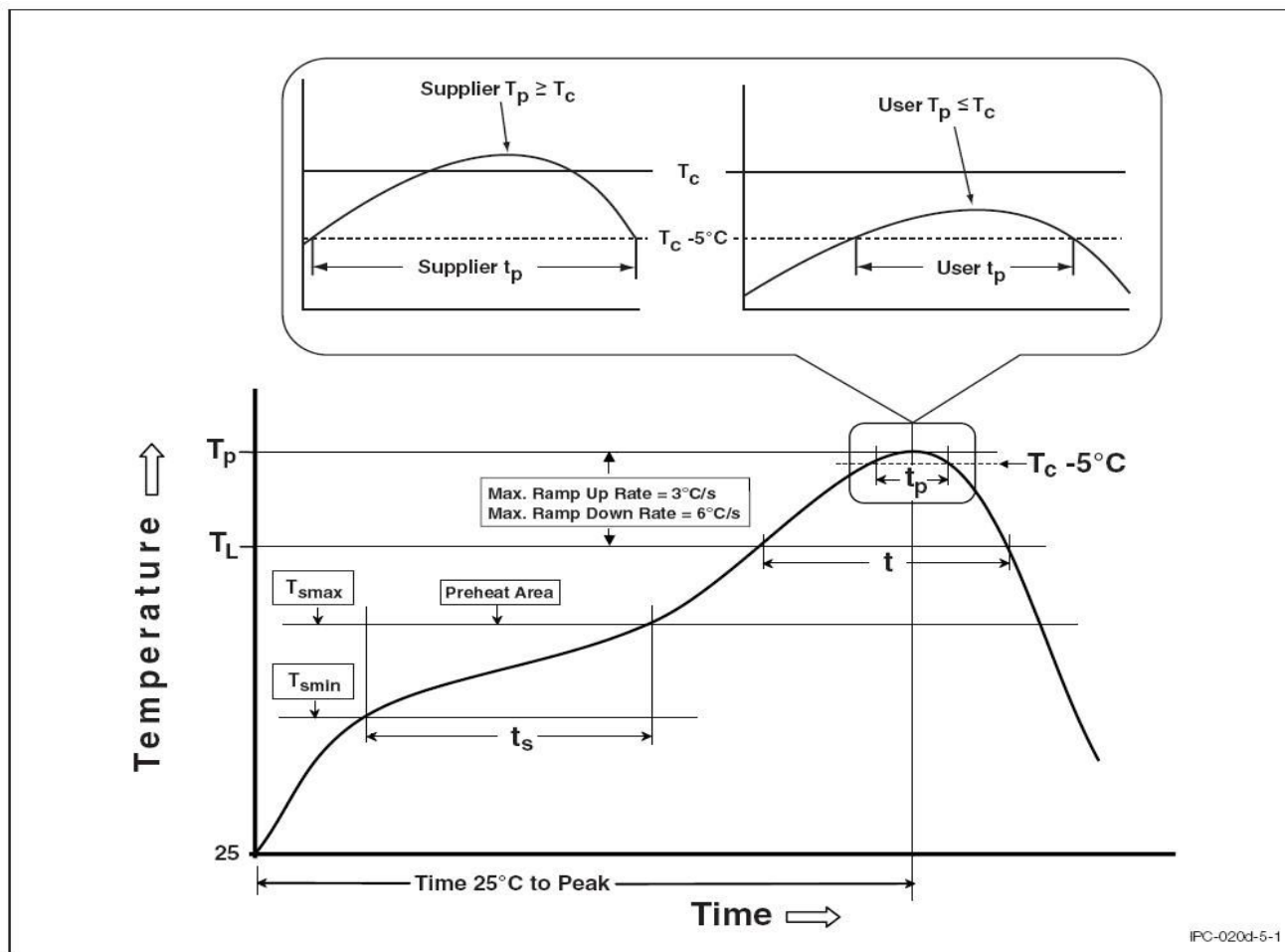

Fig.14 Test Circuits of Frequency Response



REFLOW INFORMATION

REFLOW PROFILE



IPC-0204-5-1

Profile Feature	Sn-Pb Assembly Profile	Pb-Free Assembly Profile
Temperature Min. (TsmIn)	100	150°C
Temperature Max. (Tsmax)	150	200°C
Time (ts) from (TsmIn to Tsmax)	60-120 seconds	60-120 seconds
Ramp-up Rate (tL to tP)	3°C/second max.	3°C/second max.
Liquidous Temperature (TL)	183°C	217°C
Time (tL) Maintained Above (TL)	60 – 150 seconds	60 – 150 seconds
Peak Body Package Temperature	235°C +0°C / -5°C	260°C +0°C / -5°C
Time (tP) within 5°C of 260°C	20 seconds	30 seconds
Ramp-down Rate (TP to TL)	6°C/second max	6°C/second max
Time 25°C to Peak Temperature	6 minutes max.	8 minutes max.

PACKAGE DIMENSIONS (Dimensions in mm unless otherwise stated)

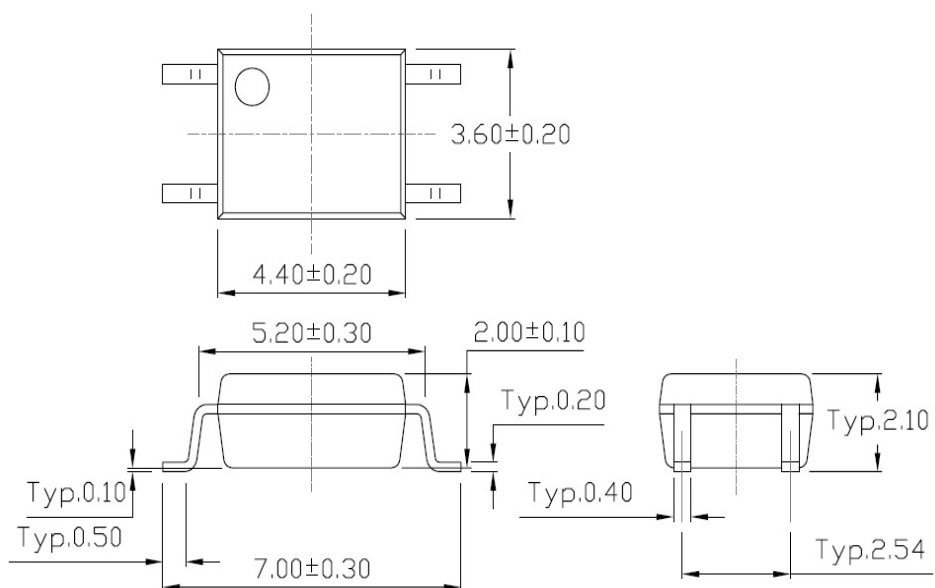

Marking

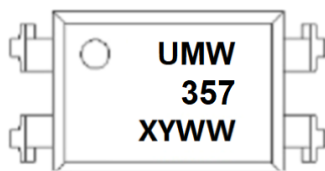

"X" : Grading standard

"YWW" : Year week number

Ordering information

Order Code	Package	Baseqty	Deliverymode
UMW PC357	SOP-4	3000	Tape and reel
UMW PC357A	SOP-4	3000	Tape and reel
UMW PC357B	SOP-4	3000	Tape and reel
UMW PC357C	SOP-4	3000	Tape and reel