

MC74AC273, MC74ACT273

Octal D Flip-Flop

The MC74AC273/74ACT273 has eight edge-triggered D-type flip-flops with individual D inputs and Q outputs. The common buffered Clock (CP) and Master Reset (\overline{MR}) inputs load and reset (clear) all flip-flops simultaneously.

The register is fully edge-triggered. The state of each D input, one setup time before the LOW-to-HIGH clock transition, is transferred to the corresponding flip-flop's Q output.

All outputs will be forced LOW independently of Clock or Data inputs by a LOW voltage level on the \overline{MR} input. The device is useful for applications where the true output only is required and the Clock and Master Reset are common to all storage elements.

- Ideal Buffer for MOS Microprocessor or Memory
- Eight Edge-Triggered D Flip-Flops
- Buffered Common Clock
- Buffered, Asynchronous Master Reset
- See MC74AC377 for Clock Enable Version
- See MC74AC373 for Transparent Latch Version
- See MC74AC374 for 3-State Version
- Outputs Source/Sink 24 mA
- 'ACT273 Has TTL Compatible Inputs

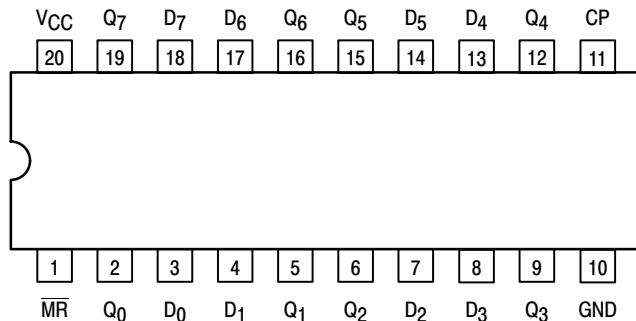

Figure 1. Pinout: 20-Lead Packages Conductors
(Top View)

PIN ASSIGNMENT

PIN	FUNCTION
D ₀ –D ₇	Data Inputs
\overline{MR}	Master Reset
CP	Clock Pulse Input
Q ₀ –Q ₇	Data Outputs



ON Semiconductor™

<http://onsemi.com>

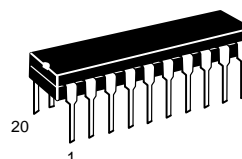

PDIP-20
N SUFFIX
CASE 738

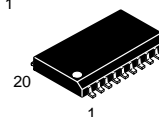

SO-20
DW SUFFIX
CASE 751

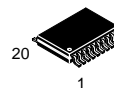

TSSOP-20
DT SUFFIX
CASE 948E

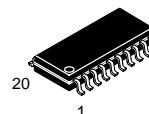

EIAJ-20
M SUFFIX
CASE 967

ORDERING INFORMATION

Device	Package	Shipping
MC74AC273N	PDIP-20	18 Units/Rail
MC74ACT273N	PDIP-20	18 Units/Rail
MC74AC273DW	SOIC-20	38 Units/Rail
MC74AC273DWR2	SOIC-20	1000 Tape & Reel
MC74ACT273DW	SOIC-20	38 Units/Rail
MC74ACT273DWR2	SOIC-20	1000 Tape & Reel
MC74AC273DT	TSSOP-20	75 Units/Rail
MC74AC273DTR2	TSSOP-20	2500 Tape & Reel
MC74ACT273DT	TSSOP-20	75 Units/Rail
MC74ACT273DTR2	TSSOP-20	2500 Tape & Reel
MC74AC273M	EIAJ-20	40 Units/Rail
MC74AC273MEL	EIAJ-20	2000 Tape & Reel
MC74ACT273M	EIAJ-20	40 Units/Rail
MC74ACT273MEL	EIAJ-20	2000 Tape & Reel

DEVICE MARKING INFORMATION

See general marking information in the device marking section on page 166 of this data sheet.

MC74AC273, MC74ACT273

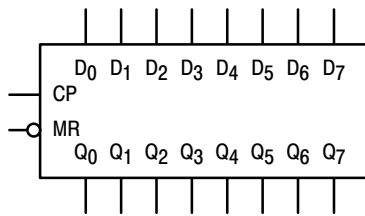
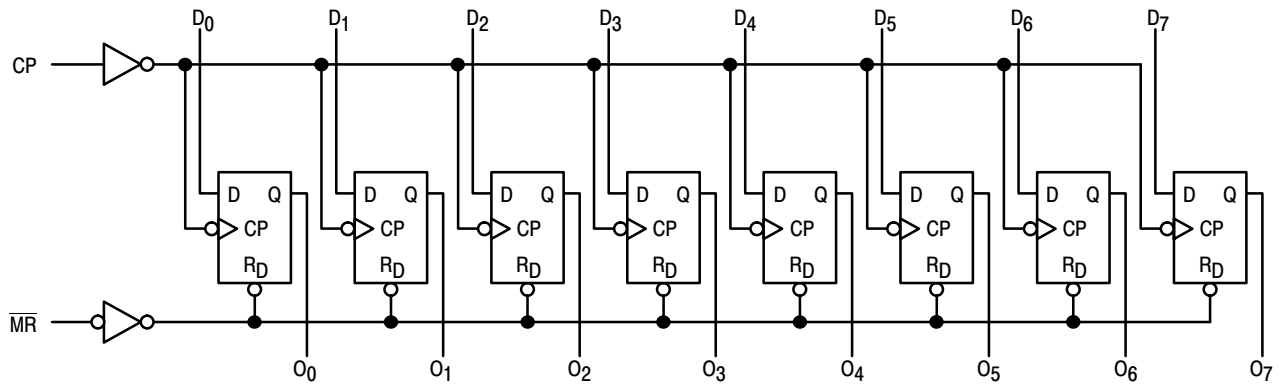

Figure 2. Logic Symbol

MODE SELECT-FUNCTION TABLE

Operating Mode	Inputs			Outputs
	\overline{MR}	CP	D_n	Q_n
Reset (Clear)	L	X	X	L
Load '1'	H	\uparrow	H	H
Load '0'	H	\uparrow	L	L

H = HIGH Voltage Level
 L = LOW Voltage Level
 X = Immaterial
 \uparrow = LOW-to-HIGH Clock Transition



NOTE: That this diagram is provided only for the understanding of logic operations and should not be used to estimate propagation delays.

Figure 3. Logic Diagram

MAXIMUM RATINGS*

Symbol	Parameter	Value	Unit
V_{CC}	DC Supply Voltage (Referenced to GND)	-0.5 to +7.0	V
V_{IN}	DC Input Voltage (Referenced to GND)	-0.5 to $V_{CC} + 0.5$	V
V_{OUT}	DC Output Voltage (Referenced to GND)	-0.5 to $V_{CC} + 0.5$	V
I_{IN}	DC Input Current, per Pin	± 20	mA
I_{OUT}	DC Output Sink/Source Current, per Pin	± 50	mA
I_{CC}	DC V_{CC} or GND Current per Output Pin	± 50	mA
T_{stg}	Storage Temperature	-65 to +150	$^{\circ}C$

*Maximum Ratings are those values beyond which damage to the device may occur. Functional operation should be restricted to the Recommended Operating Conditions.

MC74AC273, MC74ACT273

RECOMMENDED OPERATING CONDITIONS

Symbol	Parameter	Min	Typ	Max	Unit	
V _{CC}	Supply Voltage	'AC	2.0	5.0	6.0	V
		'ACT	4.5	5.0	5.5	
V _{in} , V _{out}	DC Input Voltage, Output Voltage (Ref. to GND)	0	–	V _{CC}	V	
t _r , t _f	Input Rise and Fall Time (Note 1) 'AC Devices except Schmitt Inputs	V _{CC} @ 3.0 V	–	150	–	ns/V
		V _{CC} @ 4.5 V	–	40	–	
		V _{CC} @ 5.5 V	–	25	–	
t _r , t _f	Input Rise and Fall Time (Note 2) 'ACT Devices except Schmitt Inputs	V _{CC} @ 4.5 V	–	10	–	ns/V
		V _{CC} @ 5.5 V	–	8.0	–	
T _J	Junction Temperature (PDIP)	–	–	140	°C	
T _A	Operating Ambient Temperature Range	–40	25	85	°C	
I _{OH}	Output Current – High	–	–	–24	mA	
I _{OL}	Output Current – Low	–	–	24	mA	

- V_{IN} from 30% to 70% V_{CC}; see individual Data Sheets for devices that differ from the typical input rise and fall times.
- V_{IN} from 0.8 V to 2.0 V; see individual Data Sheets for devices that differ from the typical input rise and fall times.

DC CHARACTERISTICS

Symbol	Parameter	V _{CC} (V)	74AC		74ACT	Unit	Conditions
			T _A = +25°C		T _A = –40°C to +85°C		
			Typ	Guaranteed Limits			
V _{IH}	Minimum High Level Input Voltage	3.0	1.5	2.1	2.1	V	V _{OUT} = 0.1 V or V _{CC} – 0.1 V
		4.5	2.25	3.15	3.15		
		5.5	2.75	3.85	3.85		
V _{IL}	Maximum Low Level Input Voltage	3.0	1.5	0.9	0.9	V	V _{OUT} = 0.1 V or V _{CC} – 0.1 V
		4.5	2.25	1.35	1.35		
		5.5	2.75	1.65	1.65		
V _{OH}	Minimum High Level Output Voltage	3.0	2.99	2.9	2.9	V	I _{OUT} = –50 μA
		4.5	4.49	4.4	4.4		
		5.5	5.49	5.4	5.4		
		3.0	–	2.56	2.46	V	*V _{IN} = V _{IL} or V _{IH} –12 mA I _{OH} –24 mA –24 mA
		4.5	–	3.86	3.76		
5.5	–	4.86	4.76				
V _{OL}	Maximum Low Level Output Voltage	3.0	0.002	0.1	0.1	V	I _{OUT} = 50 μA
		4.5	0.001	0.1	0.1		
		5.5	0.001	0.1	0.1		
		3.0	–	0.36	0.44	V	*V _{IN} = V _{IL} or V _{IH} 12 mA I _{OL} 24 mA 24 mA
		4.5	–	0.36	0.44		
5.5	–	0.36	0.44				
I _{IN}	Maximum Input Leakage Current	5.5	–	±0.1	±1.0	μA	V _I = V _{CC} , GND
I _{OLD}	†Minimum Dynamic Output Current	5.5	–	–	75	mA	V _{OLD} = 1.65 V Max
I _{OHD}		5.5	–	–	–75	mA	V _{OHD} = 3.85 V Min
I _{CC}	Maximum Quiescent Supply Current	5.5	–	8.0	80	μA	V _{IN} = V _{CC} or GND

*All outputs loaded; thresholds on input associated with output under test.

†Maximum test duration 2.0 ms, one output loaded at a time.

NOTE: Note: I_{IN} and I_{CC} @ 3.0 V are guaranteed to be less than or equal to the respective limit @ 5.5 V V_{CC}.

MC74AC273, MC74ACT273

AC CHARACTERISTICS (For Figures and Waveforms – See Section 3 of the ON Semiconductor FACT Data Book, DL138/D)

Symbol	Parameter	V _{CC} * (V)	74AC			74AC		Unit	Fig. No.
			T _A = +25°C C _L = 50 pF			T _A = -40°C to +85°C C _L = 50 pF			
			Min	Typ	Max	Min	Max		
f _{max}	Maximum Clock Frequency	3.3 5.0	90 140	125 175	– –	75 125	– –	Mhz	3–3
t _{PLH}	Propagation Delay Clock to Output	3.3 5.0	4.0 3.0	7.0 5.5	12.5 9.0	3.0 2.5	14.0 10.0	ns	3–6
t _{PHL}	Propagation Delay Clock to Output	3.3 5.0	4.0 3.0	7.0 5.0	13.0 10.0	3.5 2.5	14.5 11.0	ns	3–6
t _{PHL}	Propagation Delay MR to Output	3.3 5.0	4.0 3.0	7.0 5.0	13.0 10.0	3.5 2.5	14.0 10.5	ns	3–6

*Voltage Range 3.3 V is 3.3 V ±0.3 V.
Voltage Range 5.0 V is 5.0 V ±0.5 V.

AC OPERATING REQUIREMENTS

Symbol	Parameter	V _{CC} * (V)	74AC		74AC		Unit	Fig. No.
			T _A = +25°C C _L = 50 pF		T _A = -40°C to +85°C C _L = 50 pF			
			Typ	Guaranteed Minimum				
t _s	Setup Time, HIGH or LOW Data to CP	3.3 5.0	3.5 2.5	5.5 4.0	6.0 4.5	ns	3–9	
t _h	Hold Time, HIGH or LOW Data to CP	3.3 5.0	-2.0 -1.0	0 1.0	0 1.0	ns	3–9	
t _w	Clock Pulse Width HIGH or LOW	3.3 5.0	3.5 2.5	5.5 4.0	6.0 4.5	ns	3–6	
t _w	MR Pulse Width HIGH or LOW	3.3 5.0	2.0 1.5	5.5 4.0	6.0 4.5	ns	3–6	
t _{rec}	Recovery Time MR to CP	3.3 5.0	1.5 1.0	3.5 2.0	4.5 3.0	ns	3–9	

*Voltage Range 3.3 V is 3.3 V ±0.3 V.
Voltage Range 5.0 V is 5.0 V ±0.5 V.

MC74AC273, MC74ACT273

DC CHARACTERISTICS

Symbol	Parameter	V _{CC} (V)	74ACT		74ACT		Unit	Conditions
			T _A = +25°C		T _A = -40°C to +85°C			
			Typ	Guaranteed Limits				
V _{IH}	Minimum High Level Input Voltage	4.5	1.5	2.0	2.0	V	V _{OUT} = 0.1 V or V _{CC} - 0.1 V	
		5.5	1.5	2.0	2.0			
V _{IL}	Maximum Low Level Input Voltage	4.5	1.5	0.8	0.8	V	V _{OUT} = 0.1 V or V _{CC} - 0.1 V	
		5.5	1.5	0.8	0.8			
V _{OH}	Minimum High Level Output Voltage	4.5	4.49	4.4	4.4	V	I _{OUT} = -50 μA	
		5.5	5.49	5.4	5.4			
		4.5	-	3.86	3.76	V	*V _{IN} = V _{IL} or V _{IH} I _{OH} = -24 mA	
		5.5	-	4.86	4.76			
V _{OL}	Maximum Low Level Output Voltage	4.5	0.001	0.1	0.1	V	I _{OUT} = 50 μA	
		5.5	0.001	0.1	0.1			
		4.5	-	0.36	0.44	V	*V _{IN} = V _{IL} or V _{IH} I _{OL} = 24 mA	
		5.5	-	0.36	0.44			
I _{IN}	Maximum Input Leakage Current	5.5	-	±0.1	±1.0	μA	V _I = V _{CC} , GND	
ΔI _{CCCT}	Additional Max. I _{CC} /Input	5.5	0.6	-	1.5	mA	V _I = V _{CC} - 2.1 V	
I _{OLD}	†Minimum Dynamic Output Current	5.5	-	-	75	mA	V _{OLD} = 1.65 V Max	
I _{OHD}		5.5	-	-	-75	mA	V _{OHD} = 3.85 V Min	
I _{CC}	Maximum Quiescent Supply Current	5.5	-	8.0	80	μA	V _{IN} = V _{CC} or GND	

*All outputs loaded; thresholds on input associated with output under test.

†Maximum test duration 2.0 ms, one output loaded at a time.

AC CHARACTERISTICS (For Figures and Waveforms – See Section 3 of the ON Semiconductor FACT Data Book, DL138/D)

Symbol	Parameter	V _{CC} * (V)	74ACT			74ACT		Unit	Fig. No.
			T _A = +25°C C _L = 50 pF			T _A = -40°C to +85°C C _L = 50 pF			
			Min	Typ	Max	Min	Max		
f _{max}	Maximum Clock Frequency	5.0	125	200	-	125	-	MHz	3-3
t _{PHL}	Propagation Delay Clock to Output	5.0	3.0	6.0	10	2.5	11.0	ns	3-6
t _{PLH}	Propagation Delay Clock to Output	5.0	3.0	6.5	11	2.5	12.0	ns	3-6
t _{PHL}	Propagation Delay MR to Output	5.0	3.0	7.0	11	2.5	11.5	ns	3-6

*Voltage Range 5.0 V is 5.0 V ±0.5 V.

MC74AC273, MC74ACT273

AC OPERATING REQUIREMENTS

Symbol	Parameter	V _{CC} * (V)	74ACT		74ACT	Unit	Fig. No.
			T _A = +25°C C _L = 50 pF		T _A = -40°C to +85°C C _L = 50 pF		
			Typ	Guaranteed Minimum			
t _s	Setup Time, HIGH or LOW Data to CP	5.0	3.0	4.5	5.0	ns	3-9
t _h	Hold Time, HIGH or LOW Data to CP	5.0	-2.5	2.0	2.0	ns	3-9
t _w	Clock Pulse Width HIGH or LOW	5.0	2.5	4.0	4.5	ns	3-6
t _w	MR Pulse Width HIGH or LOW	5.0	2.5	4.0	4.5	ns	3-6
t _{rec}	Recovery Time MR to CP	5.0	-1.0	2.0	3.0	ns	3-6

*Voltage Range 5.0 V is 5.0 V ±0.5 V.

CAPACITANCE

Symbol	Parameter	Value Typ	Unit	Test Conditions
C _{IN}	Input Capacitance	4.5	pF	V _{CC} = 5.0 V
C _{PD}	Power Dissipation Capacitance	50	pF	V _{CC} = 5.0 V

MC74AC273, MC74ACT273

MARKING DIAGRAMS

PDIP-20



SO-20



TSSOP-20

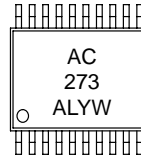

EIAJ-20

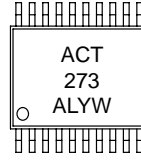
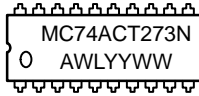

A = Assembly Location
WL, L = Wafer Lot
YY, Y = Year
WW, W = Work Week