

Product Specification

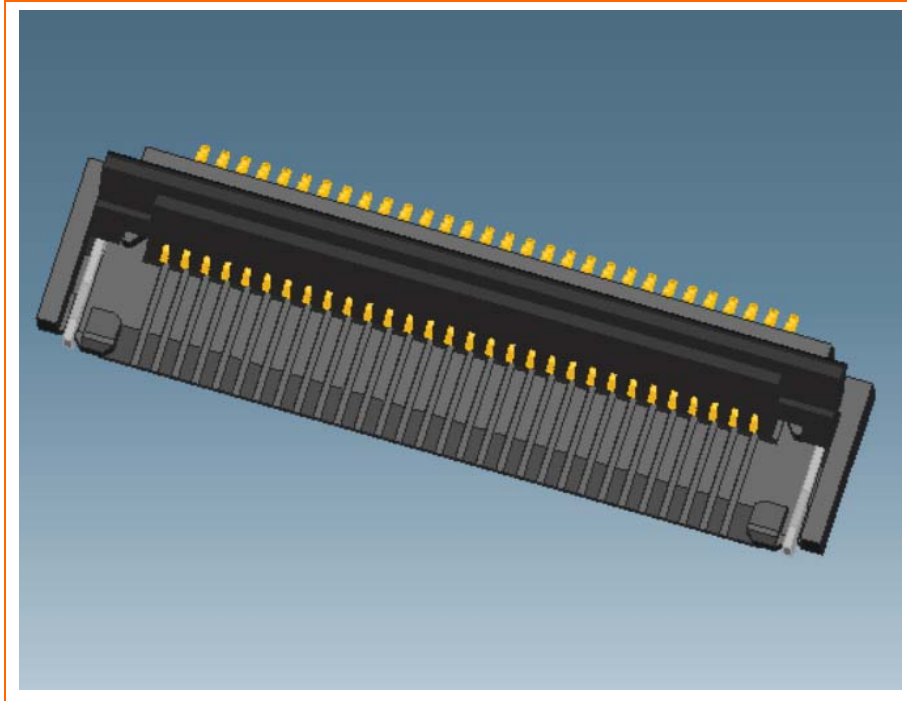

深圳市臺華達科技有限公司

SHENZHENSHI THD TECHNOLOGY Co., Ltd.



Product.No

THD05175x-xxCL-GF

**Pitch=0.50mm,H=1.75/1.95 mm FPC Connector
(Front-Flip Lower Contact)**

A	Release
Rev.	Description

Approved Signatures

■Prepared By : JIM	■Date: 2012.05.24
■Checked By : JIM	■Date: 2012.05.24
■Approved By : 黄德进	■Date: 2012.05.24

■ Scope

This specification covers the 0.5 mm Pitch FPC Connector **THD05175** series.

■ Ordering information

THD05175 - xx CL - GF

① ② ③ ④

①	Series name : THD05175	④	Plating : GF= 1μ"~3μ" Gold Flash G3= 3μ" Gold over Nickel G5= 5μ" Gold over Nickel SN= Tin(Lead Free) over Nickel
②	Number of contacts : 6 TO 60		
③	Contact type : CL:Lower contact CU:Upper contact		

■ Rating

Item	Standard
Voltage Rating(Max.)	50V AC
Current Rating(Max.)	0.5A DC
Operating Temperature Range	-25°C ~ +85°C (Including terminal temperature rise)

■ Material

Housing	Actuator	Terminal	Plating	Solder pin	Plating
L.C.P (UL94V-0)	L.C.P (UL94V-0)	PHOSPHOR BRONZE	1μ" Gold Flash over Nickel	PHOSPHOR BRONZE	100μ"~150μ" TIN(LEAD FREE) over Nickel
Color : NC/BK	Color : NC/BK				

■ Performance

Item	Test Condition	Specification	
Contact Resistance	Mate applicable FPC and measure by dry circuit, 20mV Max, 1mA.	30 mΩ Max.	
Insulation Resistance	Mate applicable FPC and apply 500V DC between adjacent terminal or ground.	500 MΩ Min.	
Dielectric Strength	Mate applicable FPC, apply 250V AC(rms) for 1 minute between adjacent terminal or ground.	No Breakdown	
FPC Retention Force	Insert the actuator, pull the FPC at a rate of 25±3mm per minute.	Per pin x0.03Kgf (0.3N) Min.	
Terminal Retention Force	Apply axial pull out force at the rate of 25±3mm/minute on the terminal assembled in the housing.	Per pin x 0.05Kgf (0.5N) Min.	
Vibration	Mate connectors and subject to the following vibration conditions, for period of 2 hours in each of 3 mutually perpendicular axes, passing DC 1mA during the test. Amplitude : 1.5mm P-P Frequency : 10~55~10 Hz in 1 minute. Duration : 2 hours in each of X,Y,Z axes.	Appearance	No Damage
		Contact Resistance	50 mΩ Max.
		Discontinuity	1 μsec Max.
Shock	Mate applicable FPC and subject to the following shock conditions. 3 times of shocks shall be applied for each 6 directions along 3 mutually perpendicular axes, passing DC 1 mA current during the test. Peak value : 490m/s ² {50G}	Appearance	No Damage
		Contact Resistance	50 mΩ Max.
		Discontinuity	1 μsec Max.
Salt Spray	Mate applicable FPC and expose to the following salt mist conditions. Upon completion of the exposure period, salt deposits shall be removed by a gentle wash or dip in running water, after which the specified measurements shall be performed. NaCl solution Concentration : 5 ± 1% Spray time : 48 ± 4 hours Ambient temperature : 35 ± 2°C	Appearance	No Damage
		Contact Resistance	50 mΩ Max.

Item	Test Condition	Specification	
Heat Resistance	Mate applicable FPC and expose to 85±2°C for 96 hours. Upon completion of the exposure period, the test specimens shall be conditioned at ambient room conditions for 1 to 2 hours, after which the specified measurements shall be performed.	Appearance	No Damage
		Contact Resistance	50 mΩ Max.
Cold Resistance	Mate applicable FPC and expose to -40±2°C for 96 hours. Upon completion of the exposure period, the test specimens shall be conditioned at ambient room conditions for 1 to 2 hours, after which the specified measurements shall be performed.	Appearance	No Damage
		Contact Resistance	50 mΩ Max.
Humidity	Mate applicable FPC and expose to 60 ± 2°C, relative humidity 90 to 95% for 96 hours. Upon completion of the exposure period, the test specimens shall be conditioned at ambient room conditions for 1 to 2 hours, after which the specified measurements shall be performed.	Appearance	No Damage
		Contact Resistance	50 mΩ Max.
		Dielectric Strength	No Breakdown
		Insulation Resistance	100 MΩ Min.
Temperature Rise	Mate applicable FPC and measure the temperature rise of contact when the maximum AC rated current is passed.	Temperature rise	30°C Max.
Temperature Cycling	Mate applicable FPC and subject to the following conditions for 5 cycles. Upon completion of the exposure period, the test specimens shall be conditioned at ambient room conditions for 1 to 2 hours, after which the specified measurements shall be performed. 1 cycle a) -55±3°C 30minutes b) +85±3°C 30minutes (Transit time shall be with in 3 minutes)	Appearance	No Damage
		Contact Resistance	50 mΩ Max.
Solderability	Tip of solder tails and fitting nails into the molten solder (held at 245±5°C) up to 0.1mm from the bottom of the housing for 3±0.5 seconds.	Solder Wetting	95% of immersed area must show no voids, pin holes.
Resistance to Soldering	When reflowing refer to Infrared reflow condition <u>Soldering iron method</u> 0.2mm from terminal tip and fitting nail tip. Soldering time : 5 seconds Max. Solder temperature : 370~400°C	Appearance	No Damage

■ Recommended Temperature Profile

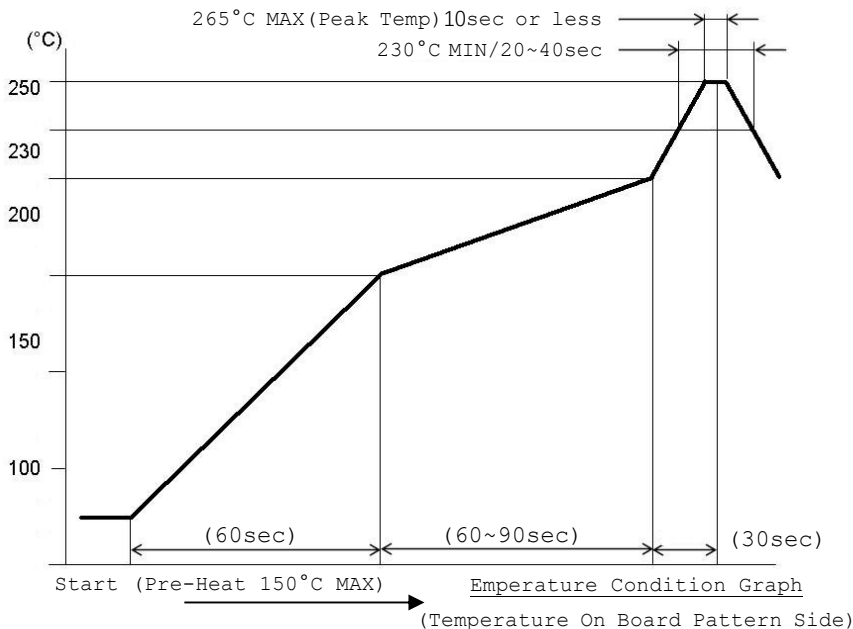

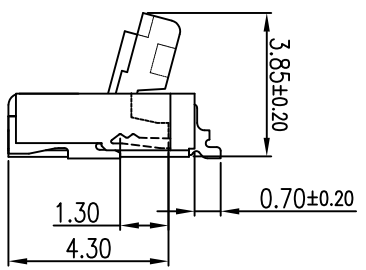
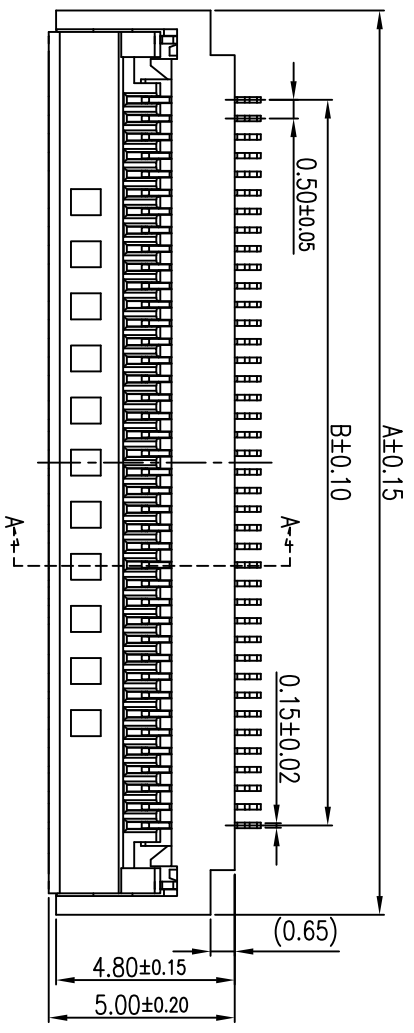

(CONTACT POSITION)
(INSERTION DEPTH OF FPC)

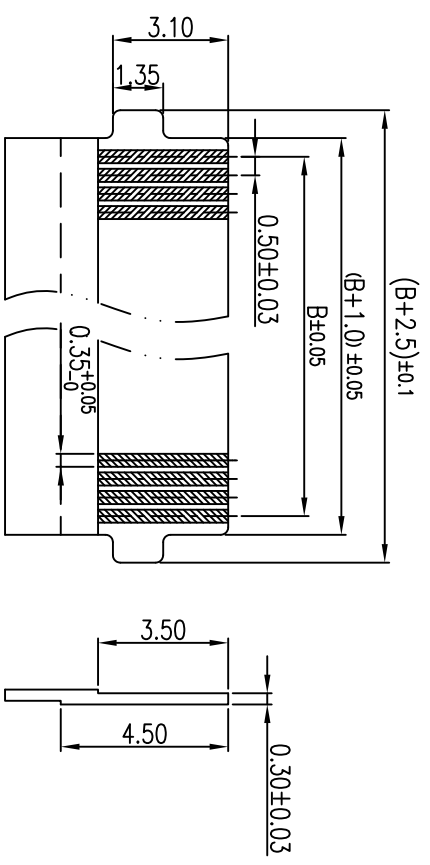
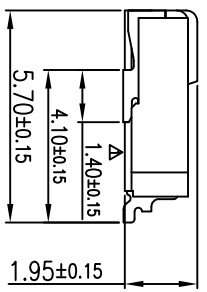
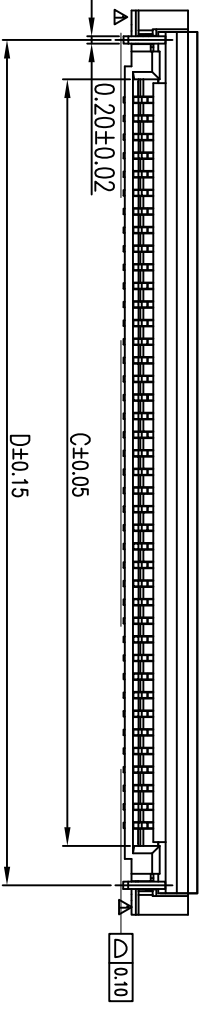

RECOMMENDED FPC DIMENSION

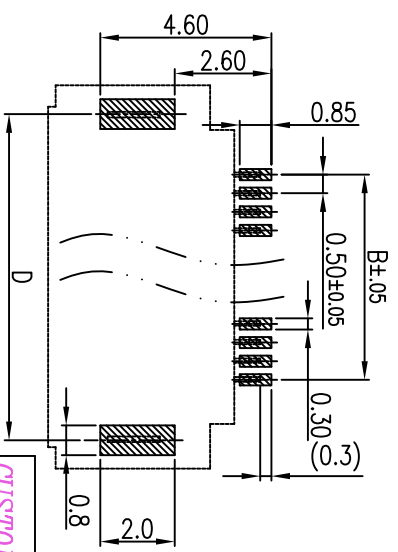
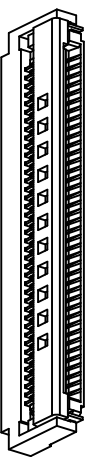

PCB LAYOUT

TOLERANCE : ±0.05

CUSTOMER

GENERAL TOLERANCE
UNLESS OTHERWISE SPECIFIED

OTHER TOLERANCE SPECIFIED

△	±0.20
△	±0.15
△	±0.10
△	±0.05
△	±0.02

SHENZHEN DONGGAISHI THD TECHNOLOGY CO., LTD.

深圳市壹華達科技有限公司
东莞市壹華達科技有限公司

DRAWN: Kawin
CHECKED: 胡文
APPROVED: 黄德进

PART NO. THD05175x-XXCL-GF
TITLE: 0.5 PITCH 1.95H FPC CONN.

DATE: 2022.03.28
SCALE: 1:1
SIZE: A4
REV: D

- MATERIAL HOUSING: LCP UL 94V-0 ACTUATOR: LCP UL 94V-0 CONTACTS: PHOSPHOR BRONZE PEG: PHOSPHOR BRONZE
- PLATING: CONTACTS: 1+ "GOLD FLASH OVERALL 50~100μ" NICKEL UNDER PLATED. PEG: 100~150μ" TIN (LEAD FREE) OVERALL 50~100μ" NICKEL UNDER PLATED.
- PERFORMANCE CHARACTERISTICS: OPERATING VOLTAGE: 50V AC, DC CURRENT RATING: 0.5A AC, DC OPERATING TEMPERATURE: -25°C~+85°C
- PART NO: THD05175B-XXCL-XX
 ▲ HEIGHT: A=1.95H
 B=1.75H
 ▲ GF: GOLD FLASH
 SN: TIN OVER NICKEL
 NO. OF CONTACTS: (08Pin~60Pin)

Table:

HEIGHT	HOUSING		ACTUATOR	
	A	B	C	D
1.95H	A	BLACK	BLACK	BLACK
	D	NATURE	BLACK	BLACK
	F	NATURE	NATURE	NATURE
	B	BLACK	BLACK	BLACK
1.75H	C	NATURE	BLACK	BLACK
E		NATURE	NATURE	NATURE

No. of Contacts	DIM.			
	A	B	C	D
06	7.30	2.50	3.60	5.72
08	8.30	3.50	4.60	6.72
09	8.80	4.00	5.10	7.22
10	9.30	4.50	5.60	7.72
12	10.30	5.50	6.60	8.72
13	10.80	6.00	7.10	9.22
15	11.80	7.00	8.10	10.22
16	12.30	7.50	8.60	10.72
18	13.30	8.50	9.60	11.72
20	14.30	9.50	10.60	12.72
24	16.30	11.50	12.60	14.72
28	18.30	13.50	14.60	16.72
30	19.30	14.50	15.60	17.72
32	20.30	15.50	16.60	18.72
40	24.30	19.50	20.60	22.72
49	28.80	24.00	25.10	27.22
50	29.30	24.50	25.60	27.72
57	32.80	28.00	29.10	31.22
60	34.30	29.50	30.60	32.72

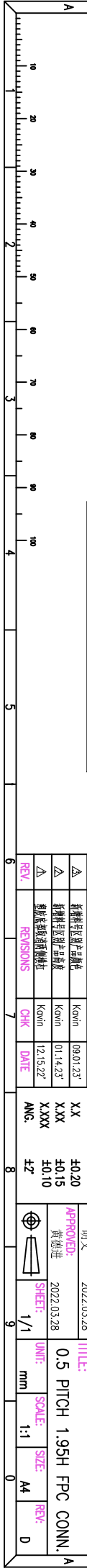

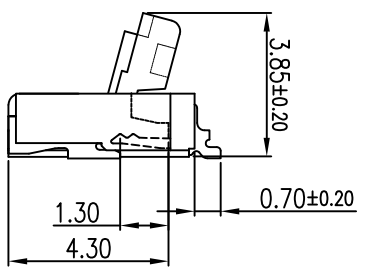
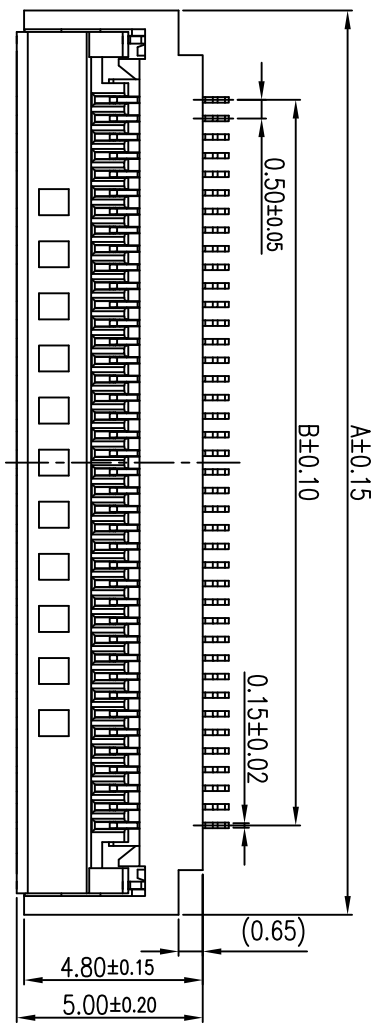

(CONTACT POSITION)
(INSERTION DEPTH OF FPC)

- 1. MATERIAL HOUSING: LCP UL 94V-0
- ACTUATOR: LCP UL 94V-0
- CONTACTS: PHOSPHOR BRONZE
- PLATING: PHOSPHOR BRONZE
- 2. PLATING: CONTACTS: 1* "GOLD FLASH OVERALL 50~100μ" NICKEL UNDER PLATED. PEG: 100~150μ" TIN (LEAD FREE) OVERALL 50~100μ" NICKEL UNDER PLATED.
- 3. PERFORMANCE CHARACTERISTICS: OPERATING VOLTAGE: 50V AC, DC CURRENT RATING: 0.5A AC, DC OPERATING TEMPERATURE: -25°C~+85°C
- 4. PART NO: THD05175B-XXCL-XX
- ▲ HEIGHT: A=1.95H GF: GOLD FLASH
- B=1.75H SN: TIN OVER NICKEL
- NO. OF CONTACTS: (08Pin~60Pin)

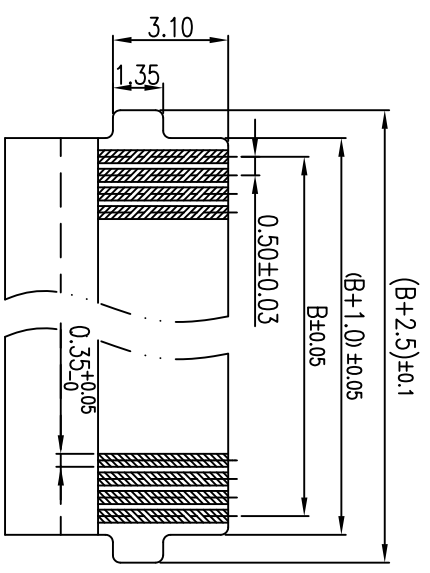
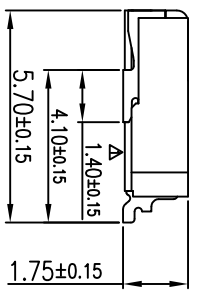
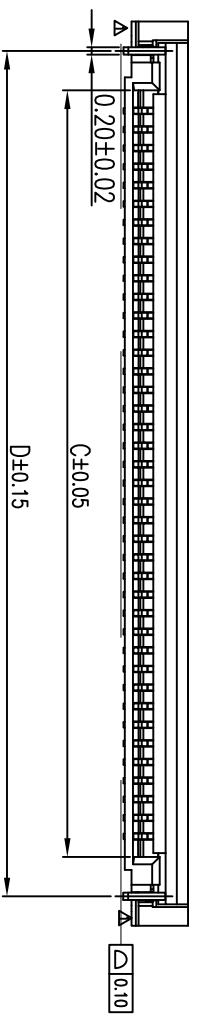

RECOMMENDED FPC DIMENSION

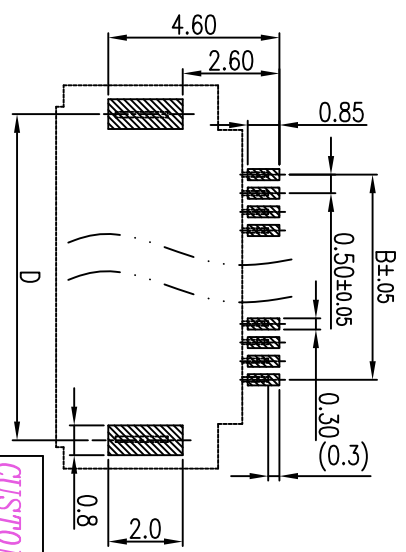
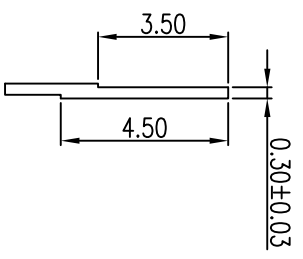

PCB LAYOUT
TOLERANCE : ±0.05

▲ Table:

HEIGHT	HOUSING	ACTUATOR	COLOR
A	BLACK	BLACK	BLACK
D	NATURE	BLACK	BLACK
F	NATURE	NATURE	NATURE
B	BLACK	BLACK	BLACK
C	NATURE	BLACK	BLACK
E	NATURE	NATURE	NATURE

No. of Contacts	A	B	C	D
06	7.30	2.50	3.60	5.72
08	8.30	3.50	4.60	6.72
09	8.80	4.00	5.10	7.22
10	9.30	4.50	5.60	7.72
12	10.30	5.50	6.60	8.72
13	10.80	6.00	7.10	9.22
15	11.80	7.00	8.10	10.22
16	12.30	7.50	8.60	10.72
18	13.30	8.50	9.60	11.72
20	14.30	9.50	10.60	12.72
24	16.30	11.50	12.60	14.72
28	18.30	13.50	14.60	16.72
30	19.30	14.50	15.60	17.72
32	20.30	15.50	16.60	18.72
40	24.30	19.50	20.60	22.72
49	28.80	24.00	25.10	27.22
50	29.30	24.50	25.60	27.72
57	32.80	28.00	29.10	31.22
60	34.30	29.50	30.60	32.72

CUSTOMER

SHENZHEN HONGGAJIANGSHI THD TECHNOLOGY CO., LTD.
深圳市壹華達科技有限公司
东莞市壹華達科技有限公司

GENERAL TOLERANCE UNLESS OTHERWISE SPECIFIED
OTHERWISE SPECIFIED
DRAWN: Kawin
CHECKED: 胡文
DATE: 2022.03.28
PART NO: THD05175x-XXCL-GF

REV. REVISIONS
REV. 1: 更改插板间距
REV. 2: 更改插板间距
REV. 3: 更改插板间距
REV. 4: 更改插板间距
REV. 5: 更改插板间距
REV. 6: 更改插板间距
REV. 7: 更改插板间距
REV. 8: 更改插板间距
REV. 9: 更改插板间距

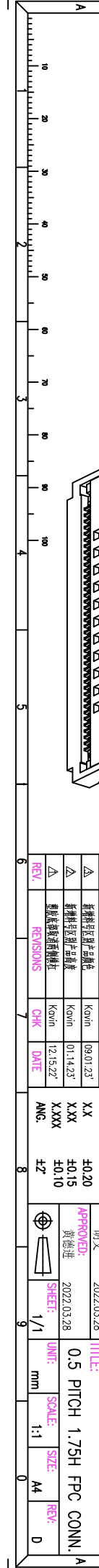

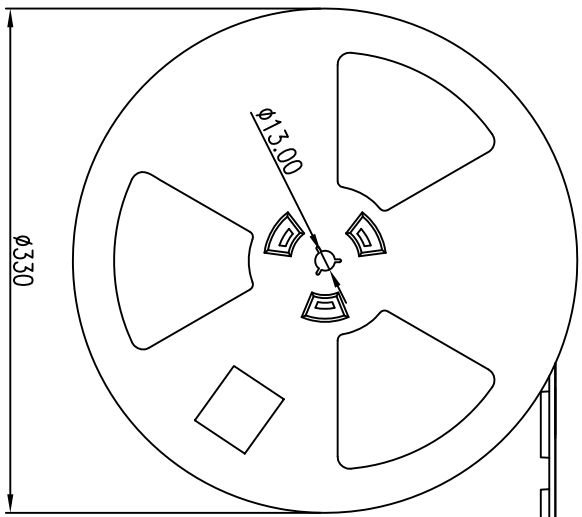

PULL OUT DIRECTION

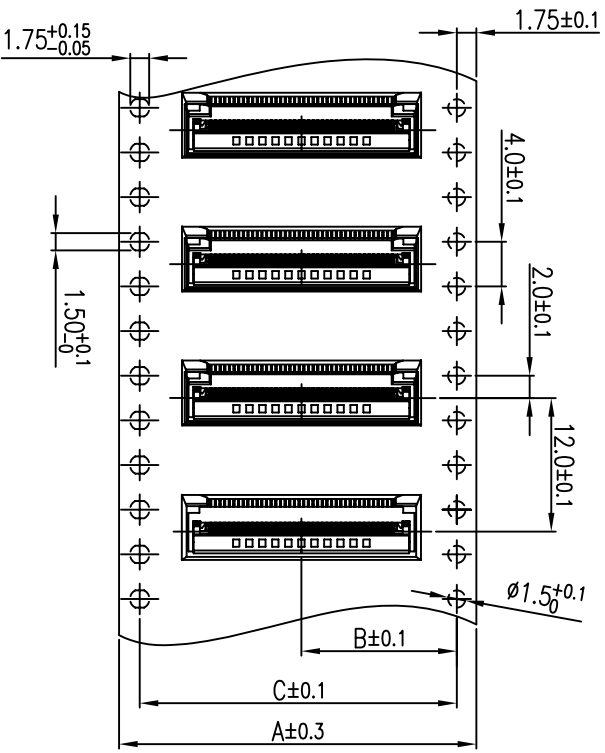
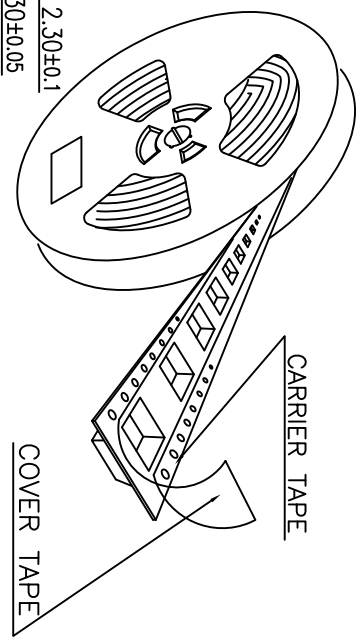
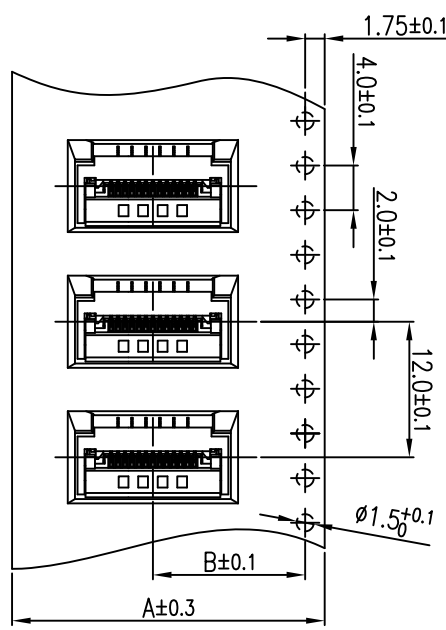

- Notes:
1. Packing Conforms EIA-481-C Standards.
 2. 10 sprocket hole pitch cumulative $\pm 0.20\text{mm}$.
 3. Carrier camber is within 1mm in 250mm.
 4. Material: Black Conductive Polystyrene Alloy.
 5. Packing length per 13" reel: 30.0 Meters.
 6. Component load per 13" reel: 2000 Pcs

Part NO.	Dimension		
	A	B	C
THD05175-60CL	56.00	20.25	40.50
THD05175-32CL~50CL	44.00	20.25	40.50
THD05175-22CL~30CL	32.00	14.25	28.50
THD05175-5CL~20CL	24.00	11.50	
THD05175-4CL	16.00	7.50	

SHENZHEN DONGGANG JIANGSHI THD TECHNOLOGY CO., LTD.
 深圳 市 壹 华 达 科 技 有 限 公 司
 SHENZHEN DONGGANG JIANGSHI THD TECHNOLOGY CO., LTD.

REV.	REVISIONS	CHK	DATE
XX			
XXX			
XXXX			
ANG.			

GENERAL TOLERANCE	OTHERWISE SPECIFIED
± 0.25	± 0.20
± 0.10	± 0.10
$\pm 3^\circ$	

DRAWN	CHECKED	DATE	TITLE
Kavin	胡文	2022.03.28	THD05175x-xxCL-GF

APPROVED	DATE	UNIT	SCALE	SIZE	REV
黄德进	2022.03.28	mm	1:1	A4	A