

FEATURES

- Fast switching
- 100% avalanche tested
- Improved dv/dt capability

APPLICATIONS

- Switch Mode Power Supply (SMPS)
- Uninterruptible Power Supply (UPS)
- Power Factor Correction (PFC)

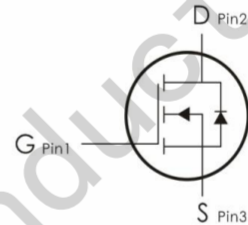
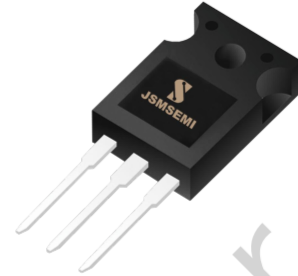

Device Marking and Package Information		
Device	Package	Marking
IRF250P225	TO-247	IRF250P225

Absolute Maximum Ratings $T_C = 25^\circ\text{C}$, unless otherwise noted			
Parameter	Symbol	Value	Unit
		TO-247	
Drain-Source Voltage	V_{DSS}	250	V
Continuous Drain Current	I_D	70	A
Pulsed Drain Current (note2)	I_{DM}	260	A
Gate-Source Voltage	V_{GSS}	± 20	V
Single Pulse Avalanche Energy (note2)	E_{AS}	780	mJ
Avalanche Current (note1)	I_{AR}	39.5	V/ns
Repetitive Avalanche Energy (note1)	E_{AR}	468	mJ
Power Dissipation ($T_C = 25^\circ\text{C}$)	P_D	400	W
Operating Junction and Storage Temperature Range	T_J, T_{stg}	-55 to 175	$^\circ\text{C}$

Thermal Resistance			
Parameter	Symbol	Value	Unit
		TO-247	
Thermal Resistance, Junction-to-Case	R_{thJC}	0.5	$^\circ\text{C/W}$
Thermal Resistance, Junction-to-Ambient	R_{thJA}	45	

Specifications $T_J = 25^\circ\text{C}$, unless otherwise noted						
Parameter	Symbol	Test Conditions	Value			Unit
			Min.	Typ.	Max.	
Static						
Drain-Source Breakdown Voltage	$V_{(BR)DSS}$	$V_{GS} = 0V, I_D = 250\mu A$	250	--	--	V
Zero Gate Voltage Drain Current	I_{DSS}	$V_{DS} = 250V, V_{GS} = 0V, T_J = 25^\circ\text{C}$	--	--	1	μA
Gate-Source Leakage	I_{GSS}	$V_{GS} = +20V, V_{DS} = 0V$	--	--	100	nA
		$V_{GS} = -20V, V_{DS} = 0V$	--	--	-100	
Gate-Source Threshold Voltage	$V_{GS(th)}$	$V_{DS} = V_{GS}, I_D = 250\mu A$	2.0	--	4.0	V
Drain-Source On-Resistance (Note3)	$R_{DS(on)}$	$V_{GS} = 10V, I_D = 25A$	--	27	35	m Ω
Dynamic						
Input Capacitance	C_{iss}	$V_{GS} = 0V,$ $V_{DS} = 25V,$ $f = 1.0\text{MHz}$	--	3538	--	pF
Output Capacitance	C_{oss}		--	657	--	
Reverse Transfer Capacitance	C_{rss}		--	280	--	
Total Gate Charge	Q_g	$V_{DD} = 160V, I_D = 25A,$ $V_{GS} = 0 \text{ to } 10V$	--	244	--	nC
Gate-Source Charge	Q_{gs}		--	16	--	
Gate-Drain Charge	Q_{gd}		--	144	--	
Turn-on Delay Time	$t_{d(on)}$	$V_{DD} = 100V, I_D = 25A,$ $V_{GS} = 10V, R_G = 25\Omega$	--	53	--	ns
Turn-on Rise Time	t_r		--	65	--	
Turn-off Delay Time	$t_{d(off)}$		--	689	--	
Turn-off Fall Time	t_f		--	230	--	
Drain-Source Body Diode Characteristics						
Continuous Body Diode Current	I_S	$T_C = 25^\circ\text{C}$	--	--	70	A
Pulsed Diode Forward Current	I_{SM}		--	--	260	
Body Diode Voltage	V_{SD}	$T_J = 25^\circ\text{C}, I_{SD} = 25A, V_{GS} = 0V$	--	--	1.5	V
Reverse Recovery Time	t_{rr}	$V_{GS} = 0V, I_S = 25A,$ $di_F/dt = 100A/\mu s$	--	208	--	ns
Reverse Recovery Charge	Q_{rr}		--	2.04	--	μC

Notes

1. Repetitive Rating: Pulse width limited by maximum junction temperature
2. $I_{AS} = 30A, V_{DD} = 30V, R_G = 25\Omega$, Starting $T_J = 25^\circ\text{C}$
3. Pulse Test: Pulse width $\leq 300\mu s$, Duty Cycle $\leq 1\%$

Typical Characteristics $T_J = 25^\circ\text{C}$, unless otherwise noted

Figure 1. Output Characteristics ($T_J = 25^\circ\text{C}$)

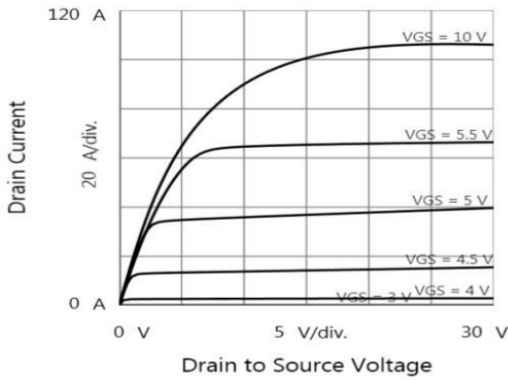

Figure 2. Transfer Characteristics

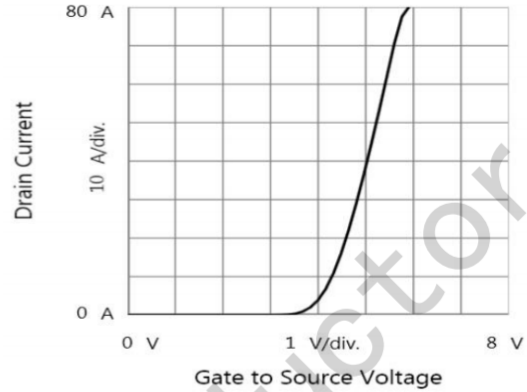

Figure 3. Maximum Continuous Drain Current vs Case Temperature

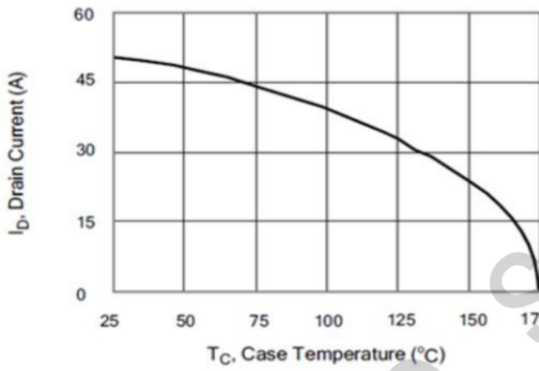

Figure 4. Drain to Source Voltage vs. Gate to Source Voltage

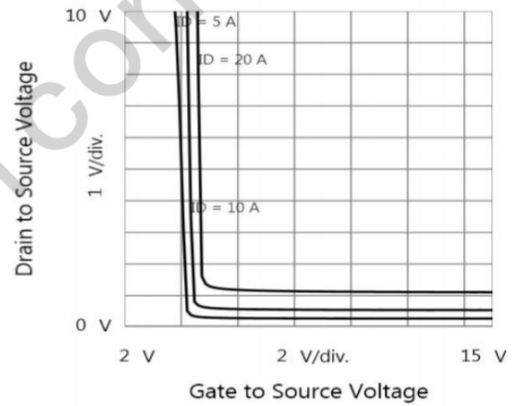

Figure 5. Typical Breakdown Voltage vs Junction Temperature

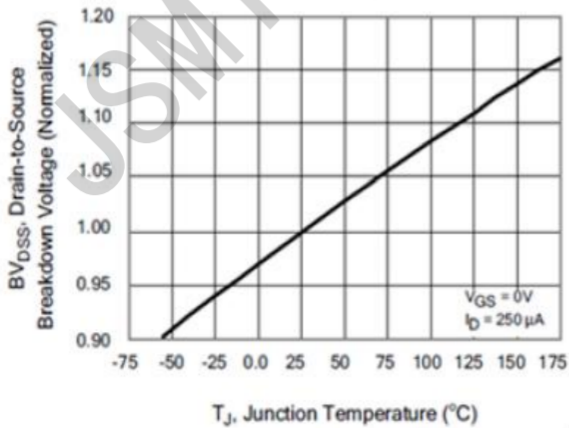
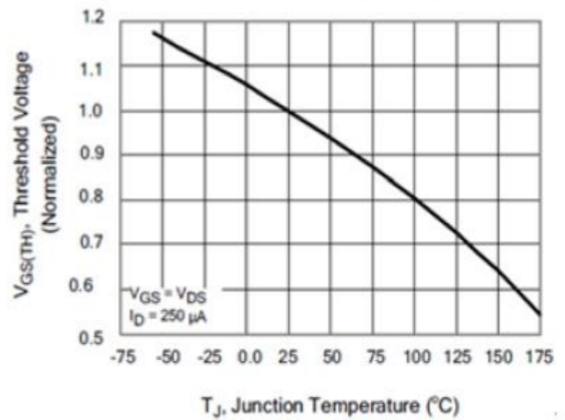

Figure 6. Typical Threshold Voltage vs Junction Temperature



Typical Characteristics $T_J = 25^\circ\text{C}$, unless otherwise noted

Figure 7. Capacitance

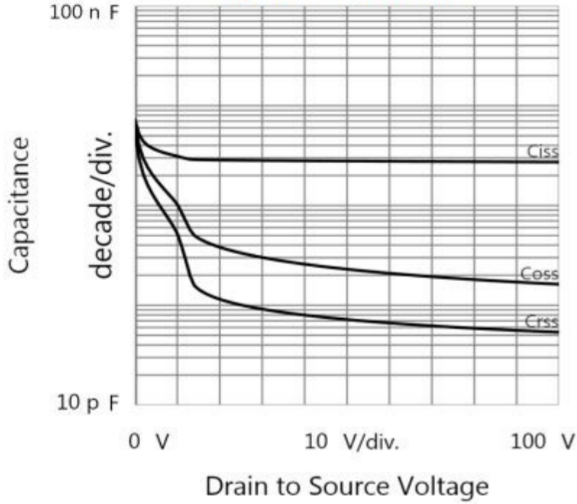

Figure 8. Gate Charge

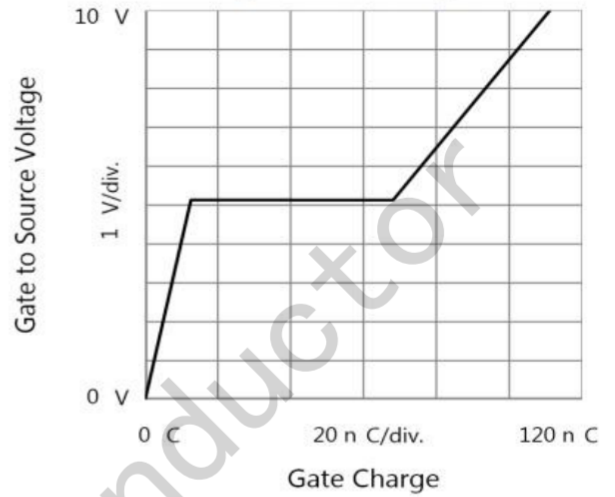

Figure 9. Transient Thermal Impedance
TO-247, TO-3P

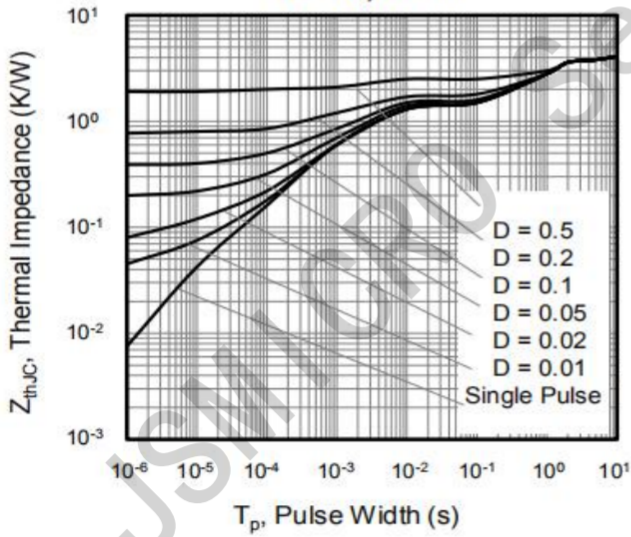

Figure 10. Maximum Forward Bias Safe Operating Area

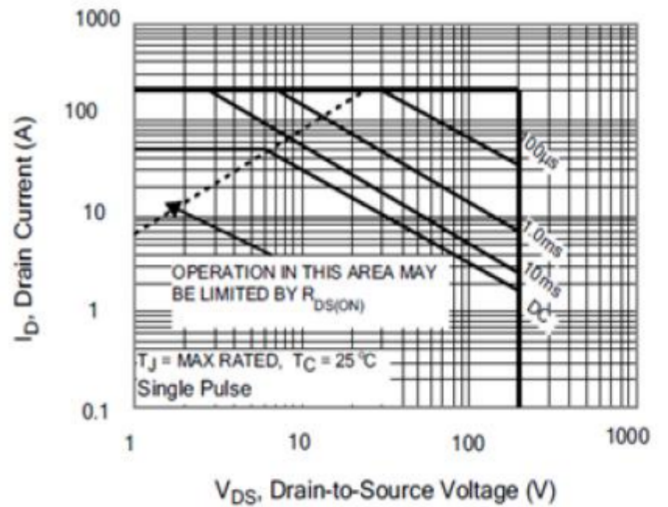

Figure A: Gate Charge Test Circuit and Waveform

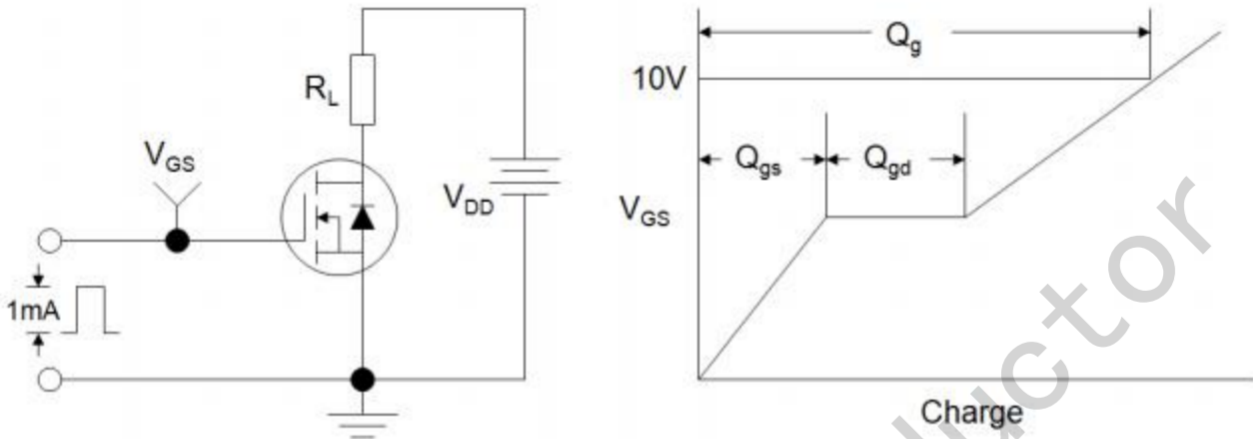

Figure B: Resistive Switching Test Circuit and Waveform

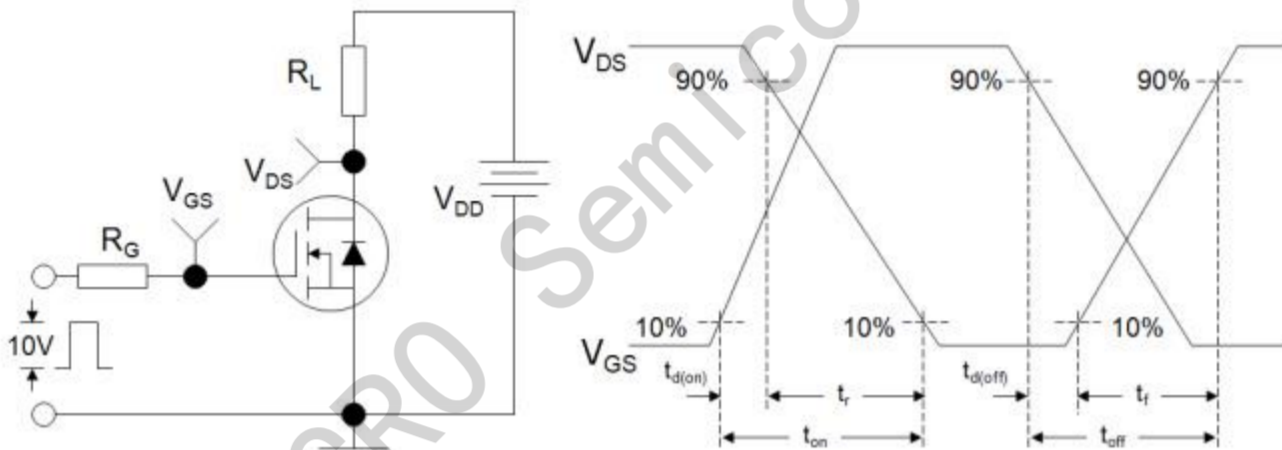
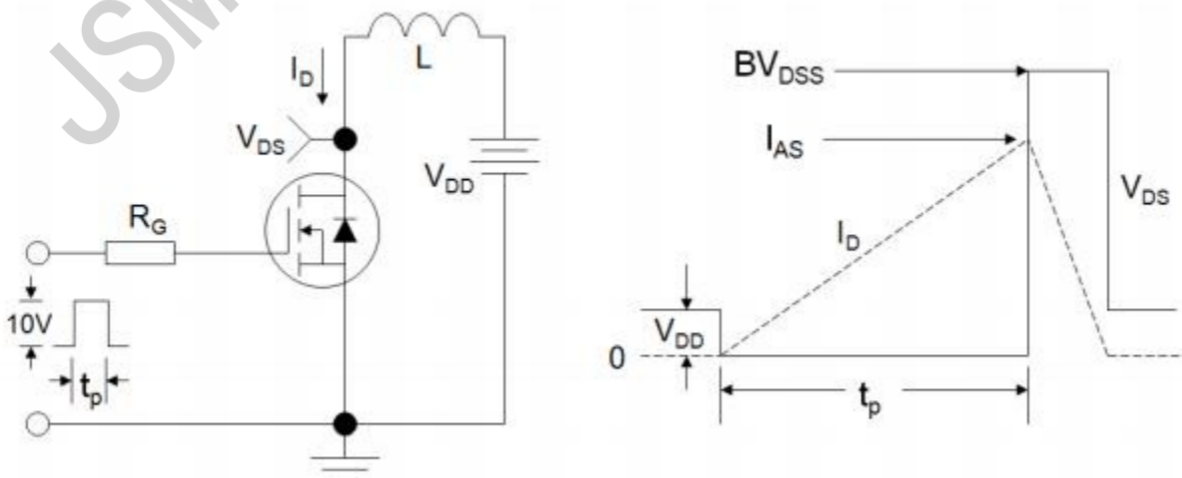
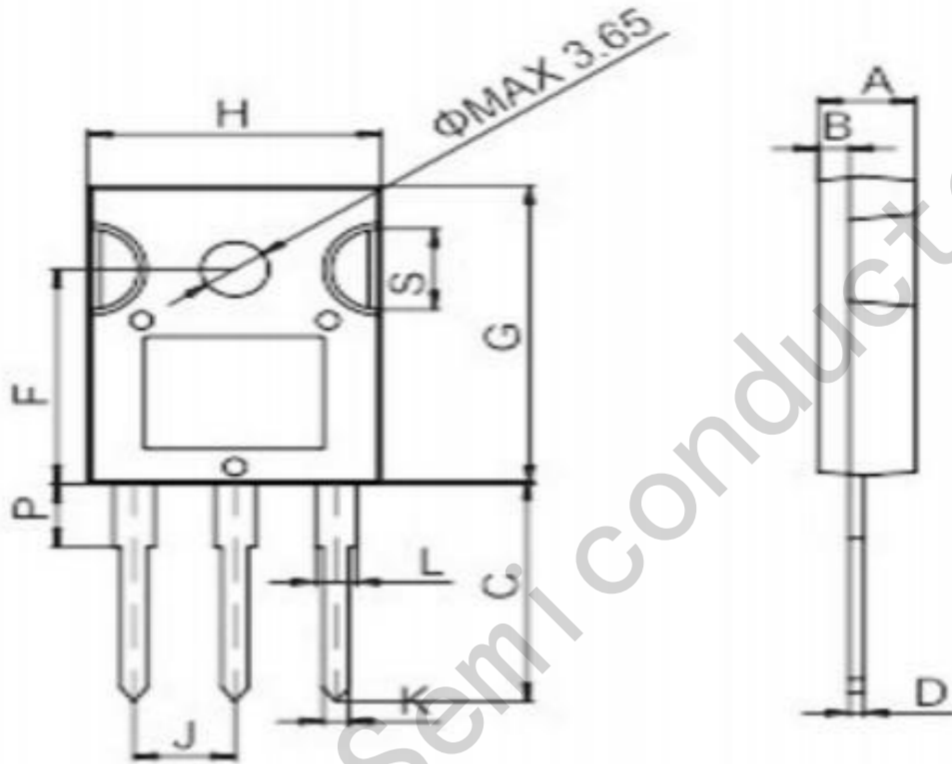

Figure C: Unclamped Inductive Switching Test Circuit and Waveform



TO-247



Ref.	Dimensions					
	Millimeters			Inches		
	Min.	Typ.	Max.	Min.	Typ.	Max.
A	4.9		5.4	0.193		0.213
B	1.6		2.0	0.063		0.079
C	14.35		15.4	0.565		0.606
D	0.5		0.8	0.020		0.031
F	14.4		15.1	0.567		0.594
G	19.7		20.6	0.775		0.811
H	15.4		16.2	0.606		0.638
J	5.3		5.6	0.209		0.220
K	1.3		1.5	0.051		0.059
L	2.8		3.3	0.110		0.130
P	3.7		4.2	0.146		0.165
S	5.35		5.65	0.211		0.222