

### ● General Description

The AGM318MAP combines advanced trench MOSFET technology with a low resistance package to provide extremely low  $R_{DS(ON)}$ .

This device is ideal for load switch and battery protection applications.

### ● Features

- Advance high cell density Trench technology
- Low  $R_{DS(ON)}$  to minimize conductive loss
- Low Gate Charge for fast switching
- Low Thermal resistance
- 100% Avalanche tested
- 100% DVDS tested

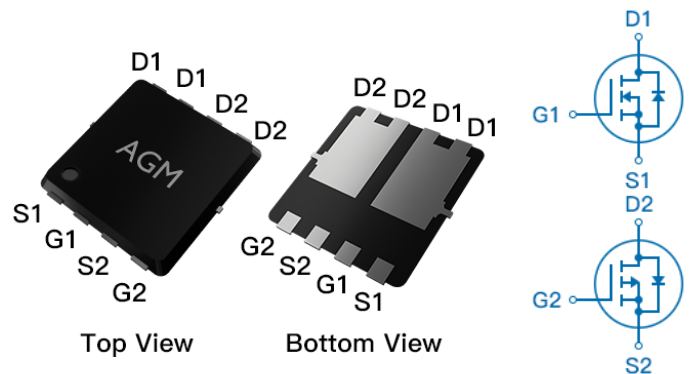
### ● Application

- MB/VGA Vcore
- SMPS 2<sup>nd</sup> Synchronous Rectifier
- POL application
- BLDC Motor driver

### Product Summary

BVDSS	RDSON	ID
30V	17mΩ	20A
-30V	23mΩ	-18A

### PDFN3.3\*3.3 Pin Configuration



### Package Marking and Ordering Information

Device Marking	Device	Device Package	Reel Size	Tape width	Quantity
AGM318MAP	AGM318MAP	PDFN3.3*3.3	330mm	12mm	5000

**Table 1. Absolute Maximum Ratings (TA=25°C)**

Symbol	Parameter	Rating		Units
		N-Ch	P-Ch	
$V_{DS}$	Drain-Source Voltage ( $V_{GS}=0V$ )	30	-30	V
$V_{GS}$	Gate-Source Voltage ( $V_{DS}=0V$ )	±20	±20	V
$I_D$	Drain Current-Continuous( $T_C=25^\circ C$ ) <sup>(Note 1)</sup>	20	-18	A
	Drain Current-Continuous( $T_C=100^\circ C$ )	13	-12	A
IDM (pluse)	Drain Current-Pulsed <sup>(Note 2)</sup>	80	-72	A
$P_D$	Total Power Dissipation( $T_C=25^\circ C$ )	14	20	W
	Total Power Dissipation( $T_C=100^\circ C$ )	5.5	8.0	W
EAS	Avalanche energy <sup>(Note 3)</sup>	36	56	mJ
TJ,TSTG	Operating Junction and Storage Temperature Range	-55 To 150	-55 To 150	°C

**Table 2. Thermal Characteristic**

Symbol	Parameter	Typ	Max	Unit
$R_{\theta JA}$	Thermal Resistance Junction-ambient (Steady State) <sup>1</sup>	---	45	°C/W
$R_{\theta JC}$	Thermal Resistance Junction-Case <sup>1</sup>	---	9   6.2	°C/W

**Table 3. N- Channel Electrical Characteristics (T<sub>J</sub>=25°C unless otherwise noted)**

Symbol	Parameter	Conditions	Min	Typ	Max	Unit
<b>On/Off States</b>						
BVDSS	Drain-Source Breakdown Voltage	VGS=0V ID=250μA	30	--	--	V
IDSS	Zero Gate Voltage Drain Current	VDS=30V,VGS=0V	--	--	1	μA
IGSS	Gate-Body Leakage Current	VGS=±20V,VDS=0V	--	--	±100	nA
VGS(th)	Gate Threshold Voltage	VDS=VGS,ID=250μA	1.2	1.6	2.2	V
gFS	Forward Transconductance	VDS=5V,ID=10A	--	10	--	S
RDS(on)	Drain-Source On-State Resistance	VGS=10V, ID=15A	--	17	22	mΩ
		VGS=4.5V, ID=10A	--	24	29	mΩ
<b>Dynamic Characteristics</b>						
Ciss	Input Capacitance	VDS=15V,VGS=0V, F=1MHZ	--	441	--	pF
Coss	Output Capacitance		--	70	--	pF
Crss	Reverse Transfer Capacitance		--	60	--	pF
Rg	Gate resistance	VGS=0V, VDS=0V,f=1.0MHz	--	2.2	--	Ω
<b>Switching Times</b>						
td(on)	Turn-on Delay Time	VDS=15V,VGS=10V, RGEN=3Ω,	--	7.0	--	nS
tr	Turn-on Rise Time		--	10	--	nS
td(off)	Turn-Off Delay Time		--	22	--	nS
tf	Turn-Off Fall Time		--	7.0	--	nS
Qg	Total Gate Charge	VGS=10V, VDS=15V, ID=8A	--	11	--	nC
Qgs	Gate-Source Charge		--	3.0	--	nC
Qgd	Gate-Drain Charge		--	4.3	--	nC
<b>Source-Drain Diode Characteristics</b>						
ISD	Source-Drain Current(Body Diode)		--	--	20	A
VSD	Forward on Voltage	VGS=0V,IS=15A	--	--	1.2	V
trr	Reverse Recovery Time	IF=15A , dI/dt=100A/μs ,	--	9.5	--	ns
Qrr	Reverse Recovery Charge	TJ=25°C	--	12	--	nc

Notes 1.The maximum current rating is package limited.

Notes 2.Repetitive Rating: Pulse width limited by maximum junction temperature

Notes 3.EAS condition: T<sub>J</sub>=25°C , VDD=15V,Vgs=10V,ID=12A, L=0.5mH,RG=25ohm

**Table 3. P-Channel Electrical Characteristics (T<sub>J</sub>=25°C unless otherwise noted)**

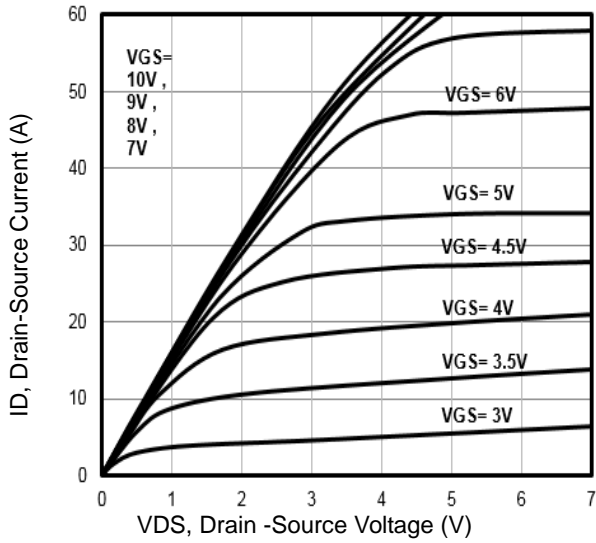
Symbol	Parameter	Conditions	Min	Typ	Max	Unit
<b>On/Off States</b>						
BVDSS	Drain-Source Breakdown Voltage	VGS=0V ID=-250μA	-30	--	--	V
IDSS	Zero Gate Voltage Drain Current	VDS=-30V, VGS=0V	--	--	-1	μA
IGSS	Gate-Body Leakage Current	VGS=±20V, VDS=0V	--	--	±100	nA
VGS(th)	Gate Threshold Voltage	VDS=VGS, ID=-250μA	-1.2	-1.5	-2.2	V
gFS	Forward Transconductance	VDS=-5V, ID=-10A	--	12	--	S
RDS(on)	Drain-Source On-State Resistance	VGS=-10V, ID=-15A	--	23	30	mΩ
		VGS=-4.5V, ID=-10A	--	34	45	mΩ
<b>Dynamic Characteristics</b>						
Ciss	Input Capacitance	VDS=-15V, VGS=0V, F=1MHZ	--	690	--	pF
Coss	Output Capacitance		--	104	--	pF
Crss	Reverse Transfer Capacitance		--	91	--	pF
Rg	Gate resistance	VGS=0V, VDS=0V, f=1.0MHz	--	11	--	Ω
<b>Switching Times</b>						
td(on)	Turn-on Delay Time	VGS=-10V, VDS=-15V, RGEN=3Ω	--	6.0	--	nS
tr	Turn-on Rise Time		--	5.0	--	nS
td(off)	Turn-Off Delay Time		--	25	--	nS
tf	Turn-Off Fall Time		--	7.0	--	nS
Qg	Total Gate Charge	VGS=-10V, VDS=-15V, ID=-8A	--	19	--	nC
Qgs	Gate-Source Charge		--	4.3	--	nC
Qgd	Gate-Drain Charge		--	6.5	--	nC
<b>Source-Drain Diode Characteristics</b>						
ISD	Source-Drain Current(Body Diode)		--	--	-18	A
VSD	Forward on Voltage	VGS=0V, IS=-15A	--	--	-1.2	V
trr	Reverse Recovery Time	IF=-15A , di/dt=100A/μs , TJ=25°C	--	7.0	--	ns
Qrr	Reverse Recovery Charge		--	6.3	--	nc

Notes 1.The maximum current rating is package limited.

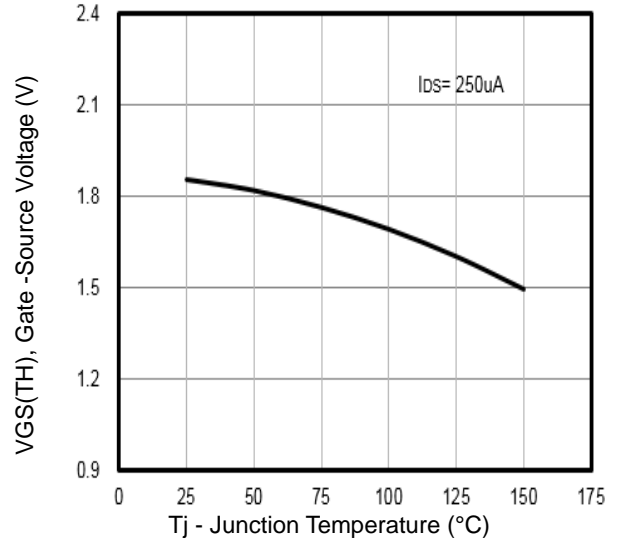
Notes2.Repetitive Rating: Pulsewidth limited by maximum junction temperature Notes

3.EAS condition: T<sub>J</sub>=25°C , VDD=-15V, Vgs=-10V, ID=-15A, L=0.5mH, RG=25ohm

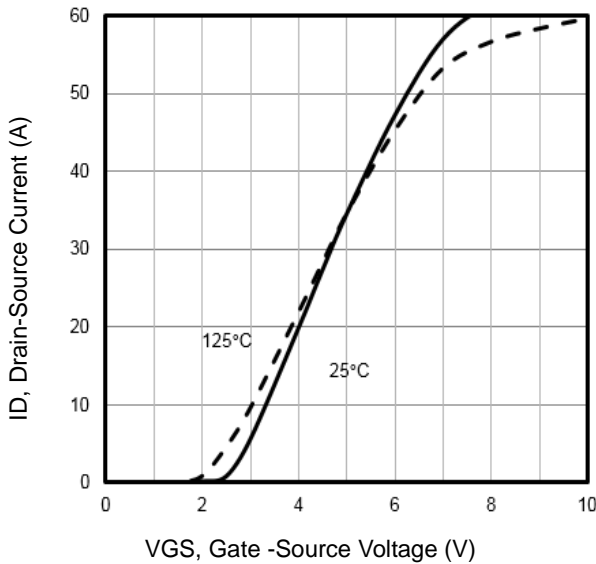
**N-Channel Typical Characteristics**



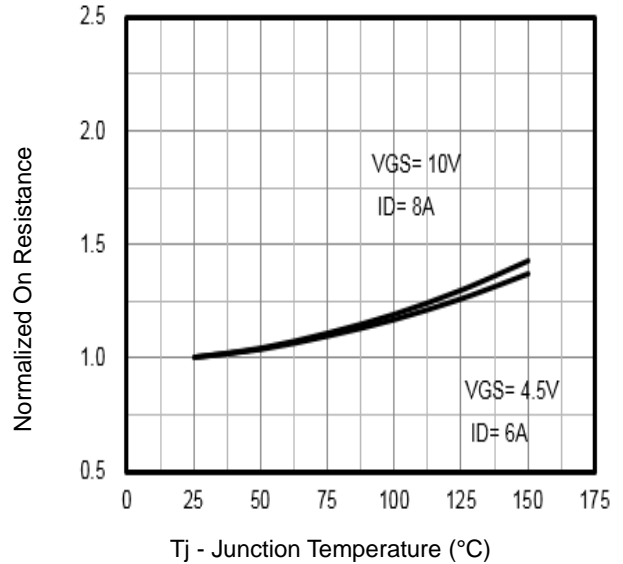
**Fig1.** Typical Output Characteristics



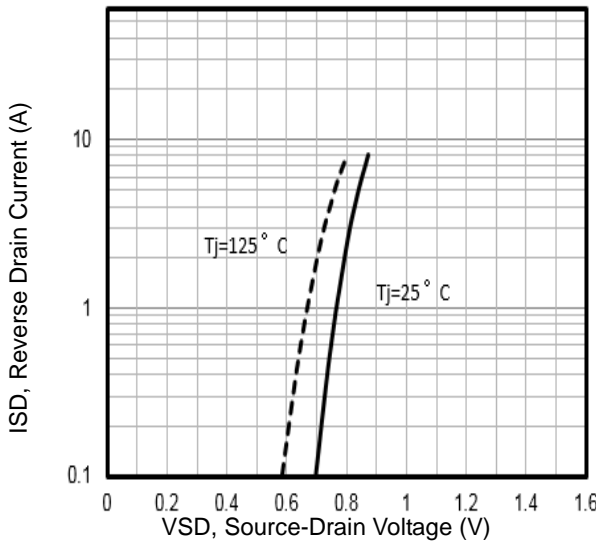
**Fig2.**  $V_{GS(TH)}$  Gate-Source Voltage Vs.  $T_j$



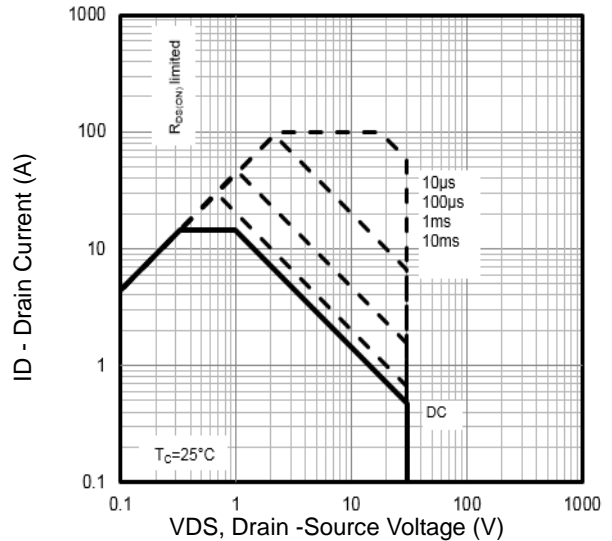
**Fig3.** Typical Transfer Characteristics



**Fig4.** Normalized On-Resistance Vs.  $T_j$

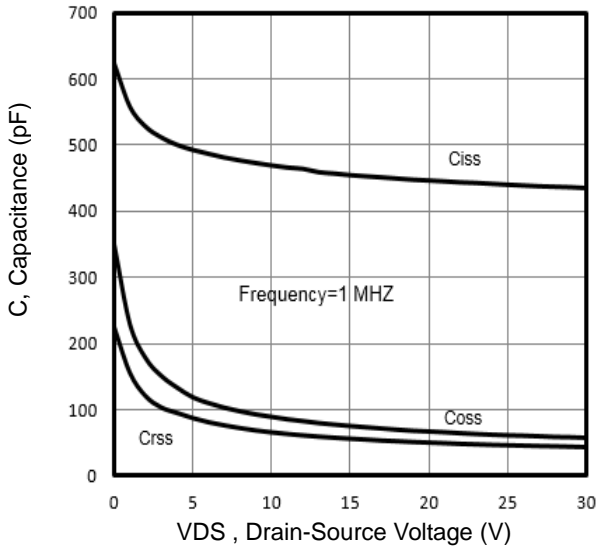


**Fig5.** Typical Source-Drain Diode Forward Voltage

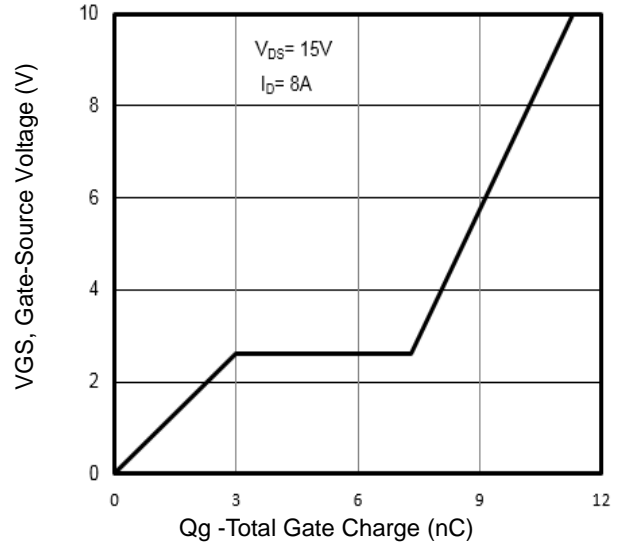


**Fig6.** Maximum Safe Operating Area

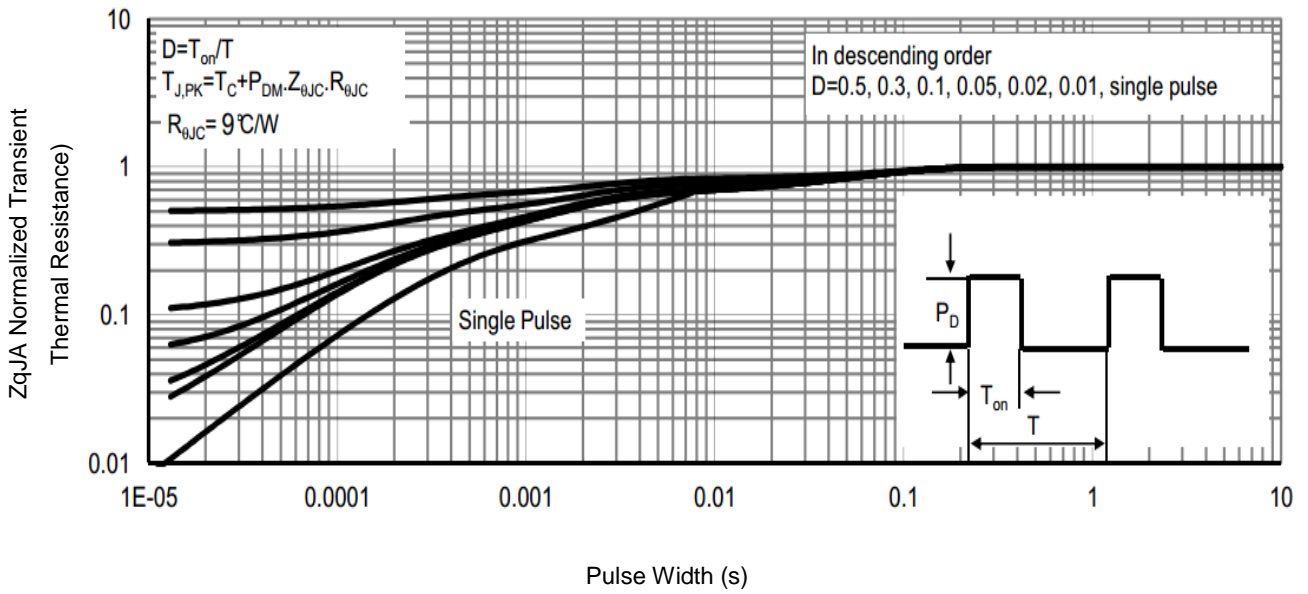
**N-Channel Typical Characteristics**



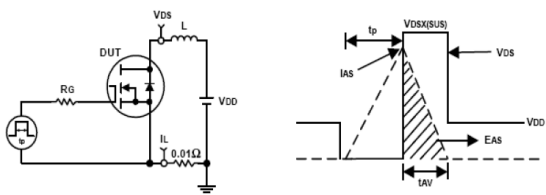
**Fig7.** Typical Capacitance Vs.Drain-Source Voltage



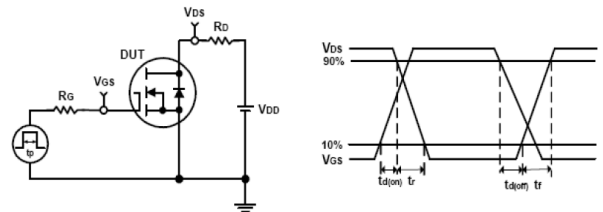
**Fig8.** Typical Gate Charge Vs.Gate-Source Voltage



**Fig 9 .**Normalized Maximum Transient Thermal Impedance



**Fig10.** Unclamped Inductive Test Circuit and waveforms



**Fig11.** Switching Time Test Circuit and waveforms

### P-Channel Typical Characteristics

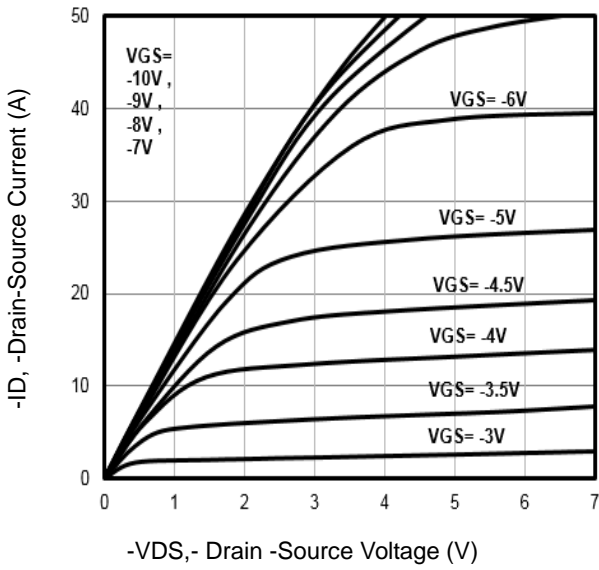


Fig1. Typical Output Characteristics

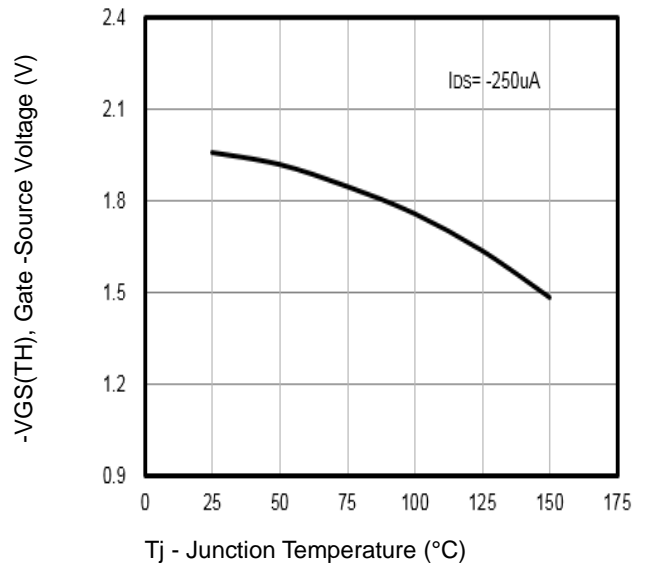


Fig2.  $-V_{GS(TH)}$  Gate -Source Voltage Vs.  $T_j$

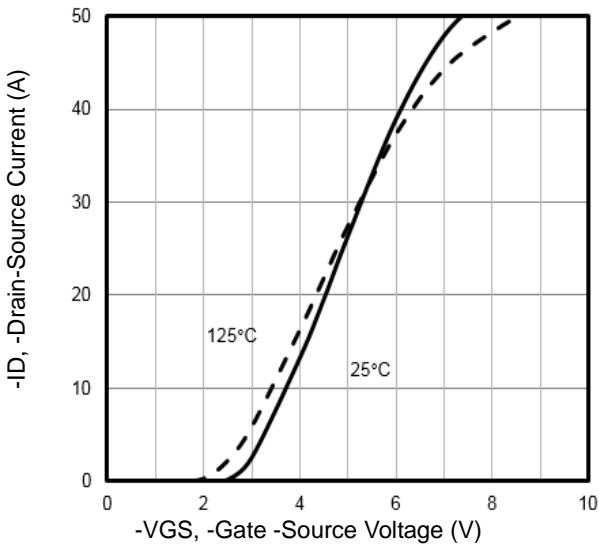


Fig3. Typical Transfer Characteristics

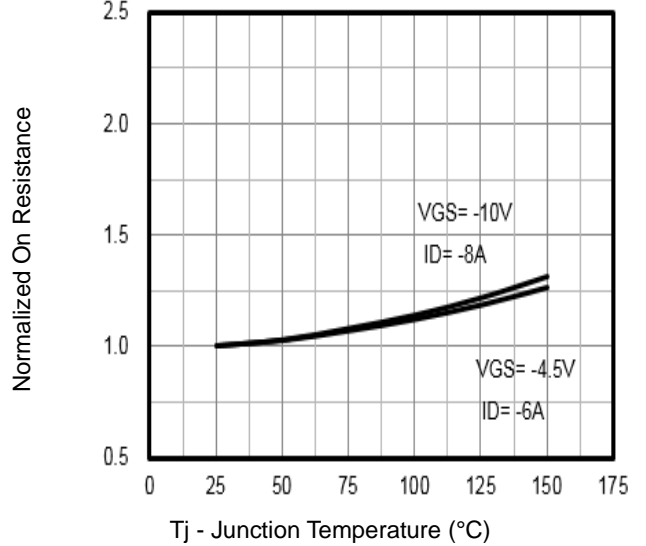


Fig4. Normalized On-Resistance Vs.  $T_j$

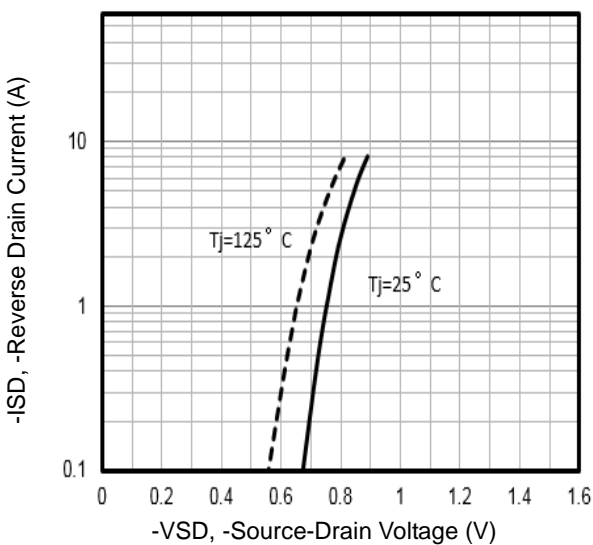


Fig5. Typical Source-Drain Diode Forward Voltage

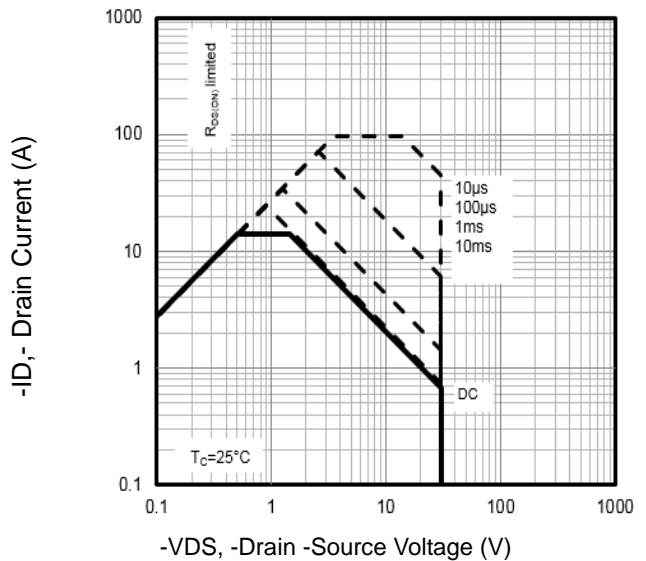


Fig6. Maximum Safe Operating Area

P-Channel Typical Characteristics

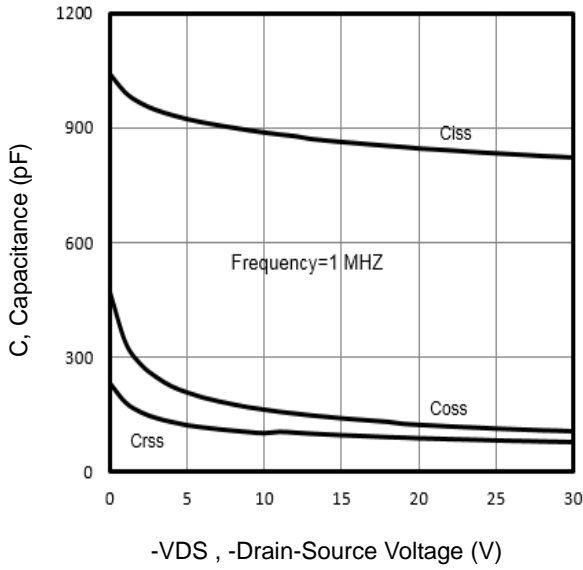


Fig7. Typical Capacitance Vs.Drain-Source Voltage

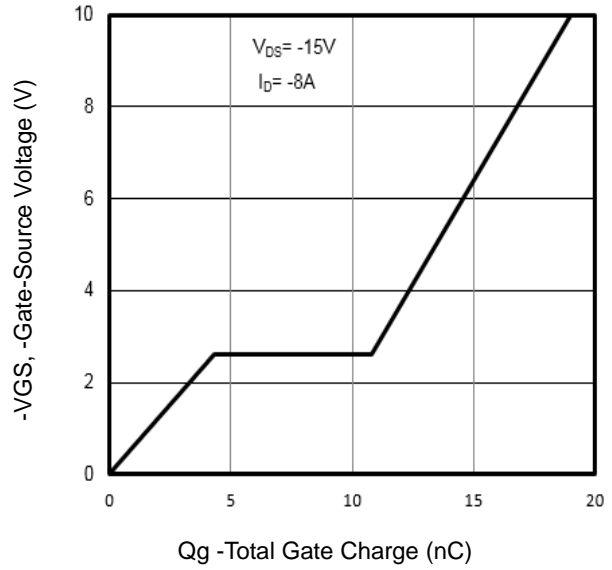


Fig8. Typical Gate Charge Vs.Gate-Source Voltage

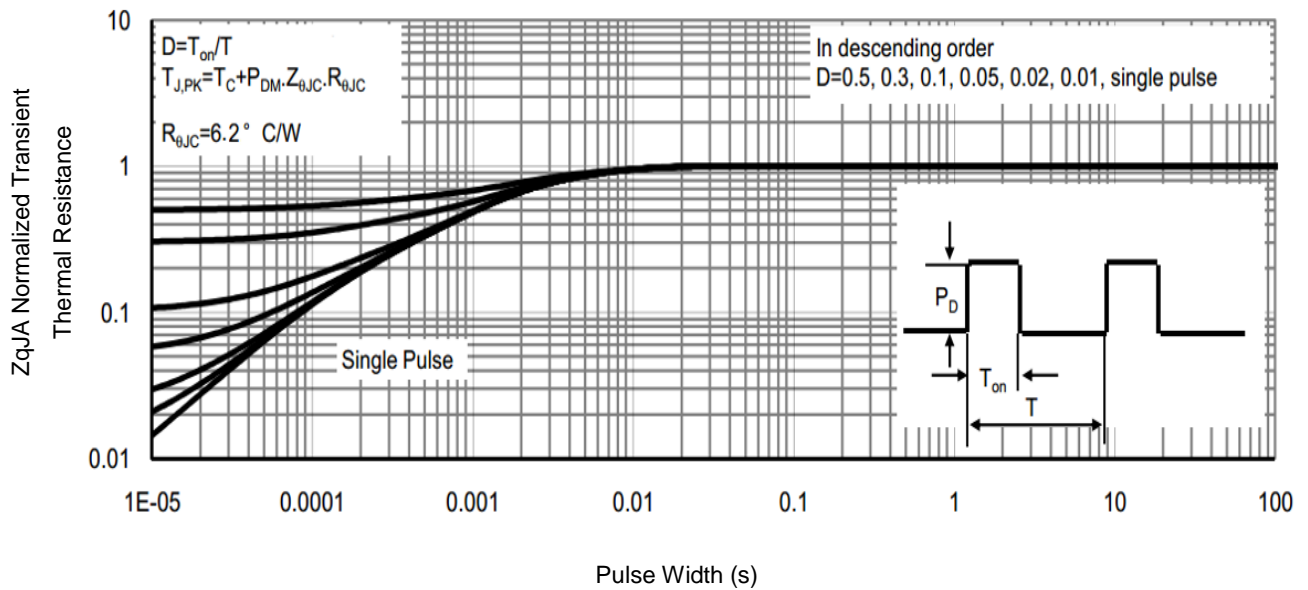


Fig9. Normalized Maximum Transient Thermal Impedance

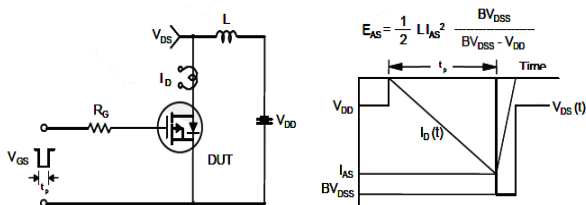


Fig10. Unclamped Inductive Test Circuit and Waveforms

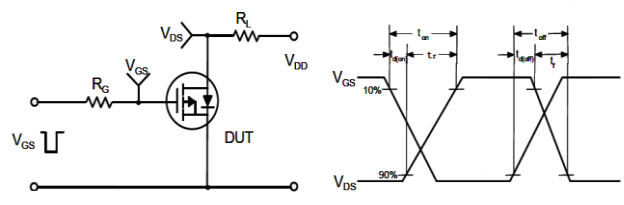
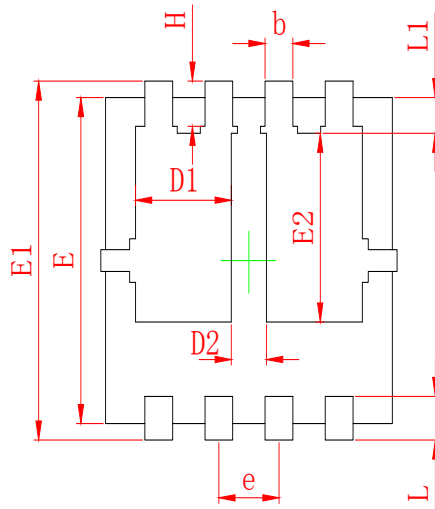
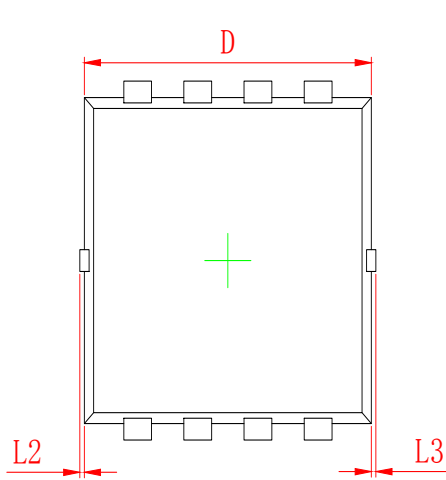
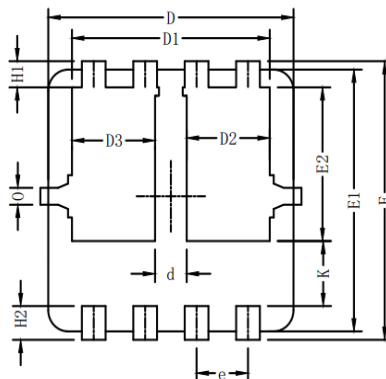
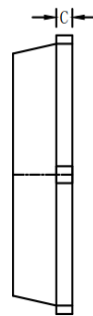
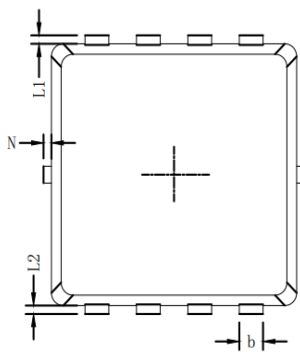
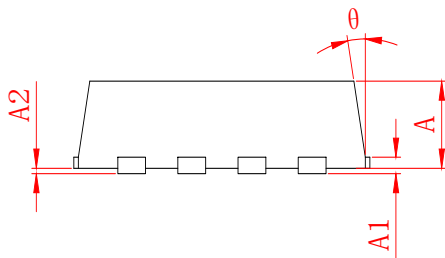


Fig11. Switching Time Test Circuit and waveforms

**•Dimensions (PDFN3.3×3.3)**


SYMBOL	MILLIMETER	
	MIN	MAX
A	0.700	0.900
A1	0.152 REF.	
A2	0 <sup>±</sup> 0.05	
D	3.000	3.200
D1	0.935	1.135
D2	0.280	0.480
E	2.900	3.100
E1	3.150	3.450
E2	1.535	1.935
b	0.200	0.400
e	0.550	0.750
L	0.300	0.500
L1	0.180	0.480
L2	0 <sup>±</sup> 0.100	
L3	0 <sup>±</sup> 0.100	
H	0.315	0.515
θ	8°	12°



Symbols	Millimeters		
	MIN.	NOM.	MAX.
A	0.65	0.75	0.85
b	0.25	0.30	0.35
C	0.15	0.20	0.25
D	3.00	3.10	3.20
D1	2.40	2.50	2.60
D2/D3	1.00	1.05	1.10
d	0.30	0.40	0.50
E	3.20	3.30	3.40
E1	3.00	3.10	3.20
E2	1.72	1.82	1.92
e	0.65 BSC.		
H1	0.21	0.31	0.41
H2	0.30	0.40	0.50
K	0.67	0.77	0.87
L1/L2	0.10 REF.		
θ	11°	12°	13°
N	0	-	0.15
0	0.2 REF.		




Disclaimer:

The information provided in this document is believed to be accurate and reliable. however, Shenzhen Core Control Electronics Technology Co., Ltd. does not assume any responsibility for the following consequences. Do not consider the use of such information or use beyond its scope.

The information mentioned in this document may be changed at any time without notice.

The products and information provided in this document do not infringe patents. Shenzhen Core Control Electronics Technology Co., Ltd. assumes no responsibility for any infringement of any other rights of third parties. The result of using such products and information.

This document is the first version issued on Dec. 10, 2023. This document replaces all previously provided information.

 It is a registered trademark of Shenzhen Core Control Electronics Technology Co., Ltd.

Copyright © 2017 Shenzhen Core Control Electronics Technology Co., Ltd. all rights reserved.