

### ● General Description

The AGM15P30AS combines advanced trench MOSFET technology with a low resistance package to provide extremely low  $R_{DS(ON)}$

This device is ideal for load switch and battery protection applications.

### ● Features

- Advance high cell density Trench technology
- Low  $R_{DS(ON)}$  to minimize conductive loss
- Low Gate Charge for fast switching
- Low Thermal resistance
- 100% Avalanche tested
- 100% DVDS tested

### ● Application

- MB/VGA Vcore
- SMPS 2<sup>nd</sup> Synchronous Rectifier
- POL application
- BLDC Motor driver

### Product Summary

BVDSS	RDSON	ID
-15V	29mΩ	-5A

### DFN2\*2 Pin Configuration

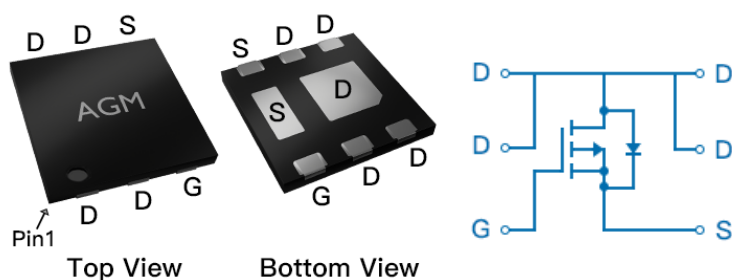

### Package Marking and Ordering Information

Device Marking	Device	Device Package	Reel Size	Tape width	Quantity
AGM15P30	AGM15P30AS	DFN2*2	178mm	8mm	3000

Table 1. Absolute Maximum Ratings (TA=25°C)

Symbol	Parameter	Value	Unit
VDS	Drain-Source Voltage (VGS=0V)	-15	V
VGS	Gate-Source Voltage (VDS=0V)	±10	V
ID	Drain Current-Continuous(Tc=25°C) <b>(Note 1)</b>	-5.0	A
	Drain Current-Continuous(Tc=100°C)	-3.4	A
IDM (pluse)	Drain Current-Pulsed <b>(Note 2)</b>	-20	A
PD	Maximum Power Dissipation(Tc=25°C)	1.0	w
	Maximum Power Dissipation(Tc=100°C)	0.4	w
EAS	Avalanche energy <b>(Note 3)</b>	---	mJ
TJ,TSTG	Operating Junction and Storage Temperature Range	-55 To 150	°C

Table 2. Thermal Characteristic

Symbol	Parameter	Typ	Max	Unit
RθJA	Thermal Resistance Junction-ambient (Steady State) <sup>1</sup>	---	125	°C/W

**Table 3. Electrical Characteristics (T<sub>J</sub>=25°C unless otherwise noted)**

Symbol	Parameter	Conditions	Min	Typ	Max	Unit
<b>On/Off States</b>						
BVDSS	Drain-Source Breakdown Voltage	VGS=0V ID=-250μA	-15	-18	--	V
IDSS	Zero Gate Voltage Drain Current	VDS=-15V,VGS=0V	--	--	-1	μA
IGSS	Gate-Body Leakage Current	VGS=±10V,VDS=0V	--	--	±100	nA
VGS(th)	Gate Threshold Voltage	VDS=VGS,ID=-250μA	-0.4	-0.6	-1.0	V
gFS	Forward Transconductance	VDS=-5V,ID=-3A	--	5	--	S
RDS(on)	Drain-Source On-State Resistance	VGS=-4.5V, ID=-3.5A	--	29	40	mΩ
		VGS=-2.5V, ID=-3A	--	38.5	50	mΩ
<b>Dynamic Characteristics</b>						
Ciss	Input Capacitance	VDS=-10V,VGS=0V, F=1MHZ	--	418	--	pF
Coss	Output Capacitance		--	93	--	pF
Crss	Reverse Transfer Capacitance		--	86	--	pF
Rg	Gate resistance	f=1.0MHz	--	13	--	Ω
<b>Switching Times</b>						
td(on)	Turn-on Delay Time	ID =-3.3A VDS = -10V VGS =-4.5V RG = 10Ω	--	12	--	nS
tr	Turn-on Rise Time		--	32	--	nS
td(off)	Turn-Off Delay Time		--	30	--	nS
tf	Turn-Off Fall Time		--	11	--	nS
Qg	Total Gate Charge	VGS=-10V, VDS=-10V, ID=-3.3A	--	12	--	nC
Qgs	Gate-Source Charge		--	0.7	--	nC
Qgd	Gate-Drain Charge		--	1.6	--	nC
<b>Source-Drain Diode Characteristics</b>						
ISD	Source-Drain Current(Body Diode)		--	--	-5.0	A
VSD	Forward on Voltage	VGS=0V,IS=-3.5A	--	--	-1.2	V
trr	Reverse Recovery Time	Isd=-3.5A , di/dt=100A/μs , TJ=25°C	--	--	--	ns
Qrr	Reverse Recovery Charge		--	--	--	nc

Notes 1.The maximum current rating is package limited.

Notes 2.Repetitive Rating: Pulse width limited by maximum junction temperature

Notes 3.EAS condition: T<sub>J</sub>=25°C

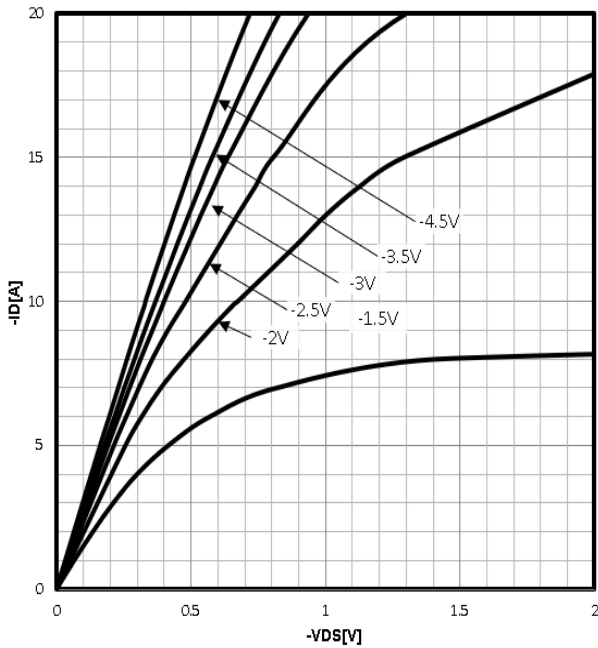
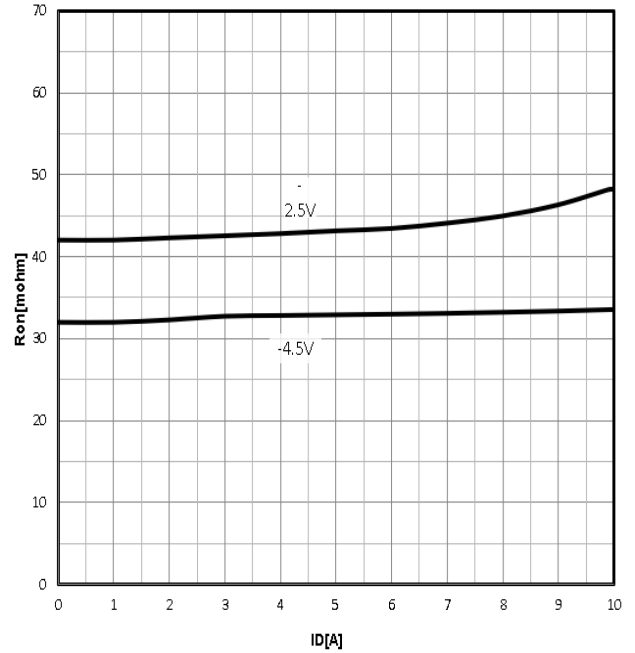
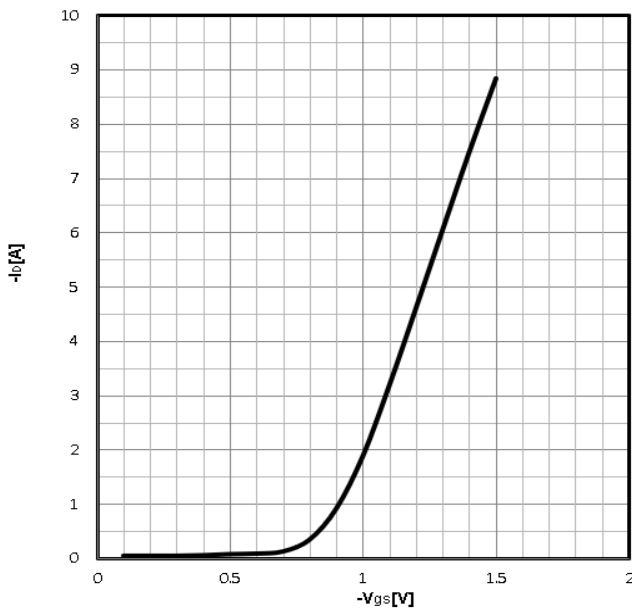
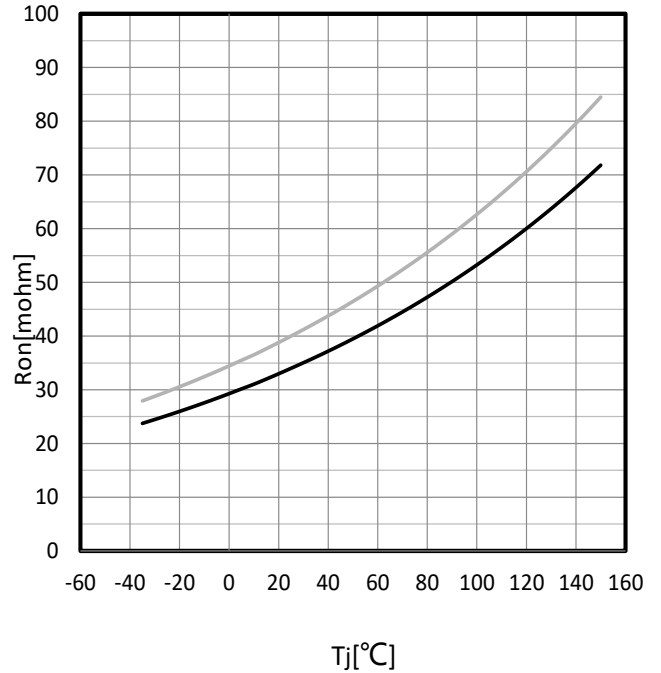
**Characteristics Curve:**
**Typ. output characteristics**  
 $I_D = f(V_{DS})$ 

**Typ. drain-source on resistance**  
 $R_{DS(on)} = f(I_D)$ 

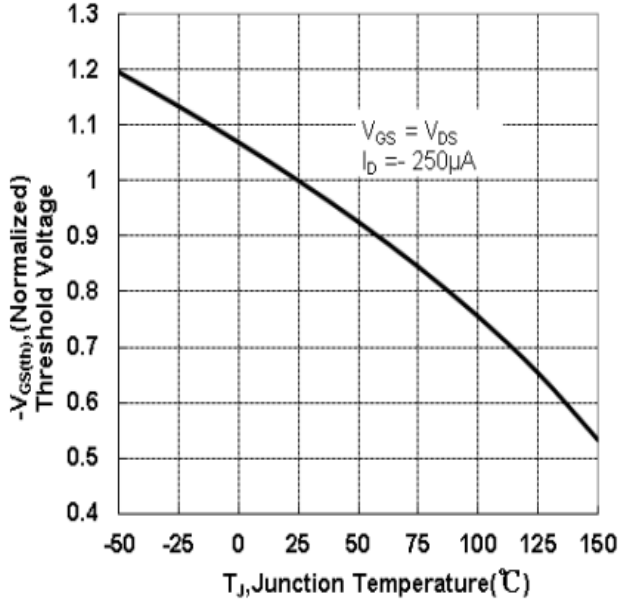
**Typ. transfer characteristics**  
 $I_D = f(V_{GS})$ 

**Drain-source on-state resistance**  
 $R_{DS(on)} = f(T_j); I_D = -3.5A$ 

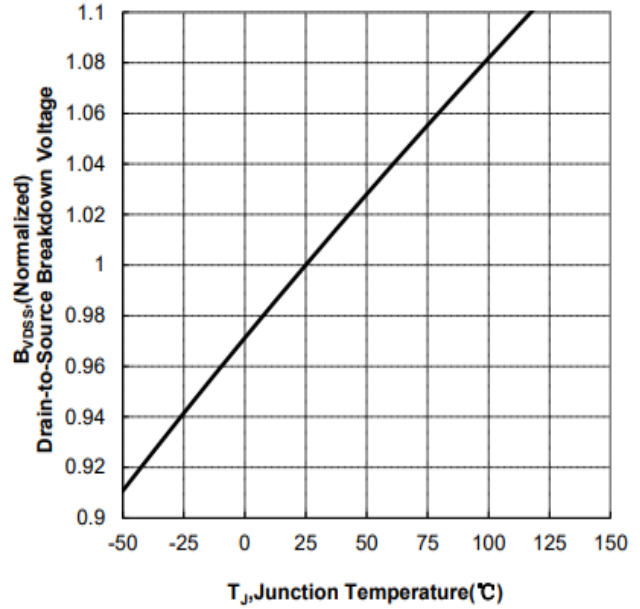
**Gate Threshold Voltage**  
 $-V_{TH}=f(T_j); I_D=-250\mu A$



**Drain-source breakdown voltage**  
 $V_{BR(DSS)}=f(T_j); I_D=-250\mu A$



**Typ. gate charge**  
 $V_{GS}=f(Q_g); I_D=-3.3A$

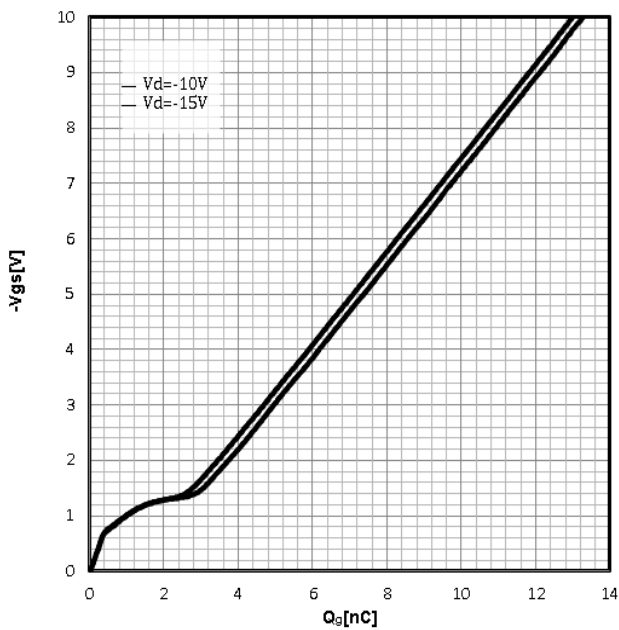

**Typ. capacitances**  
 $C=f(V_{DS}); V_{GS}=0V; f=1MHz$

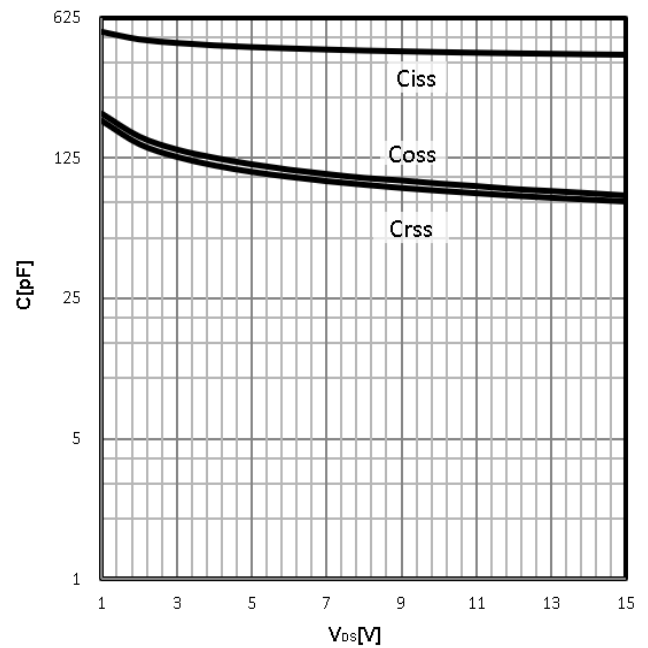

**Power Dissipation**

$$P_{tot}=f(T_C)$$

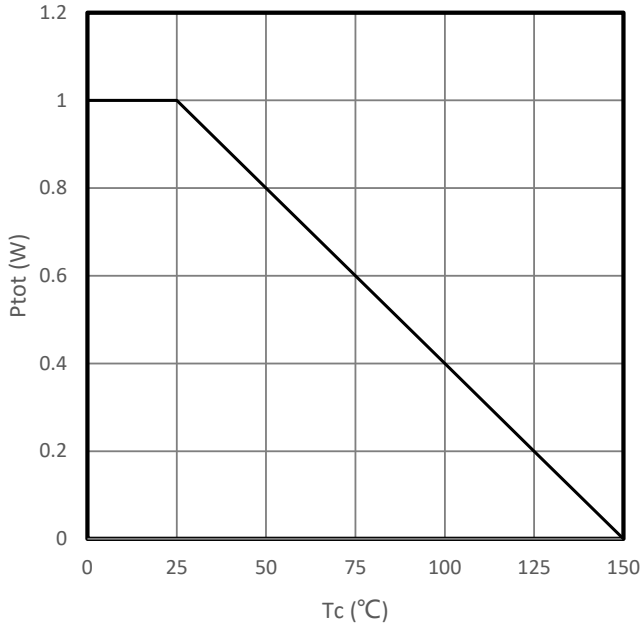
**Maximum Drain Current**

$$-I_D=f(T_C)$$

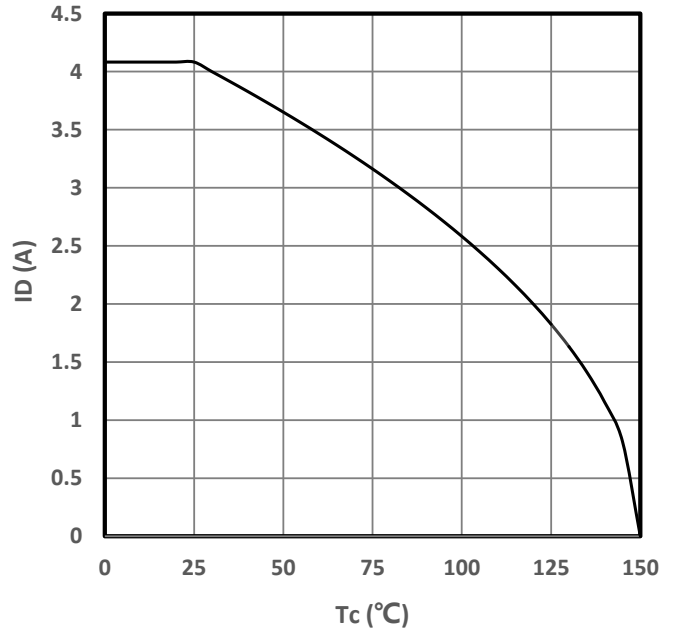
**Safe operating area**

$$-I_D=f(-V_{DS})$$

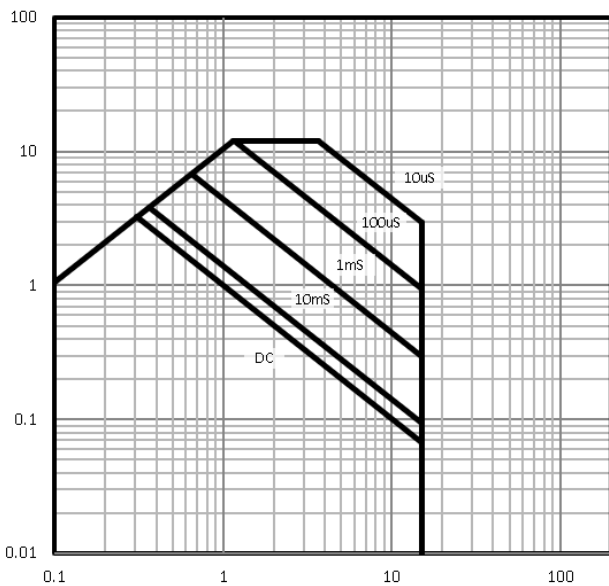

**Body Diode Forward Voltage Variation**

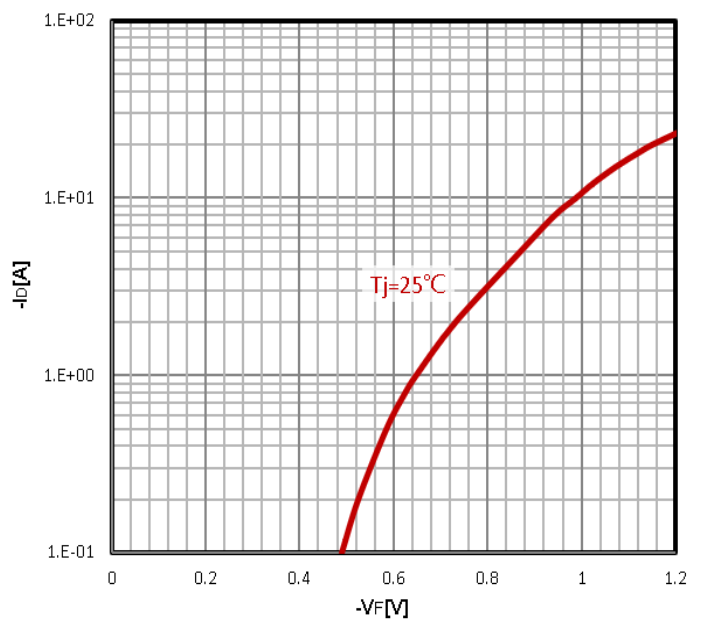
$$-I_F=f(-V_{GS})$$

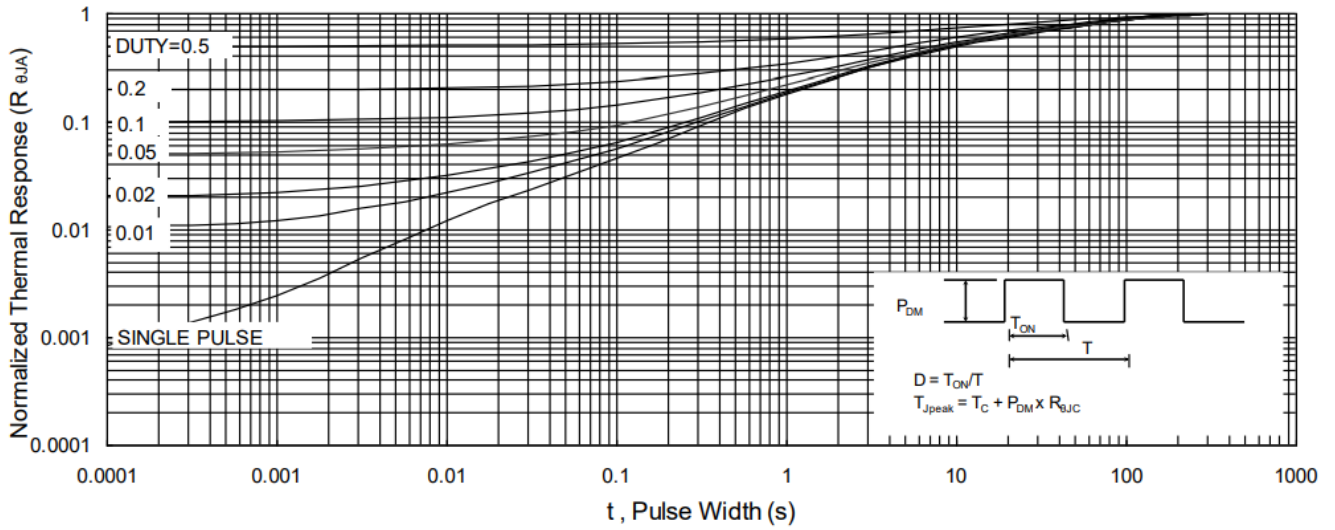

### Max. transient thermal impedance

$$Z_{thJC} = f(t_p)$$



### Test Circuit and Waveform:

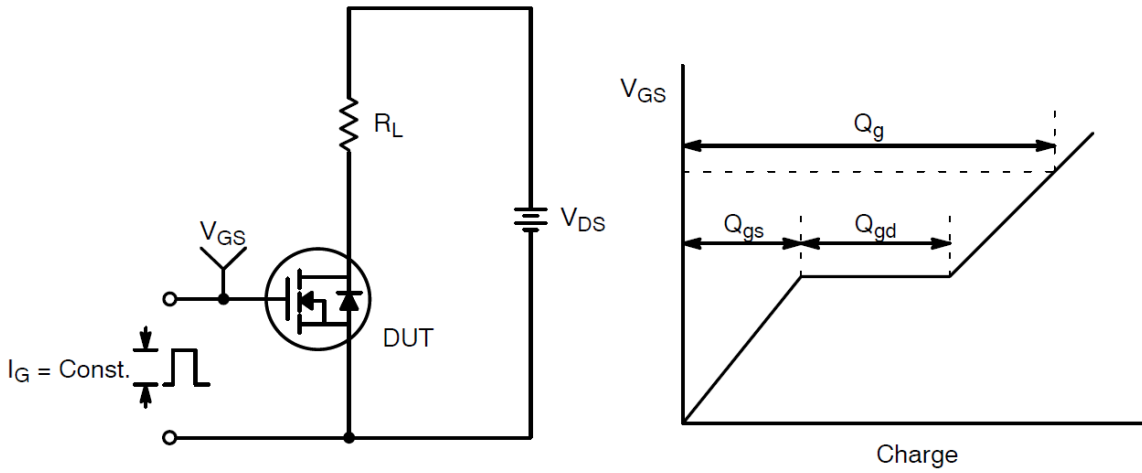

**Gate Charge Test Circuit & Waveform**

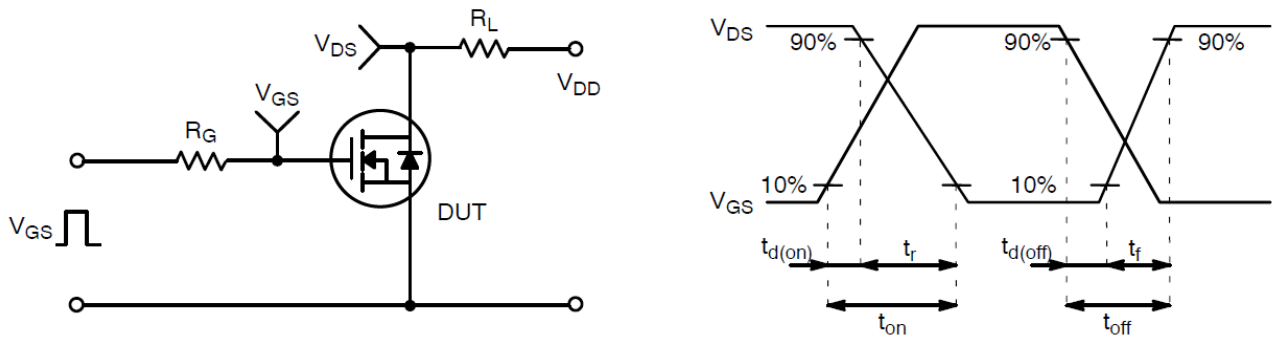

**Resistive Switching Test Circuit & Waveforms**

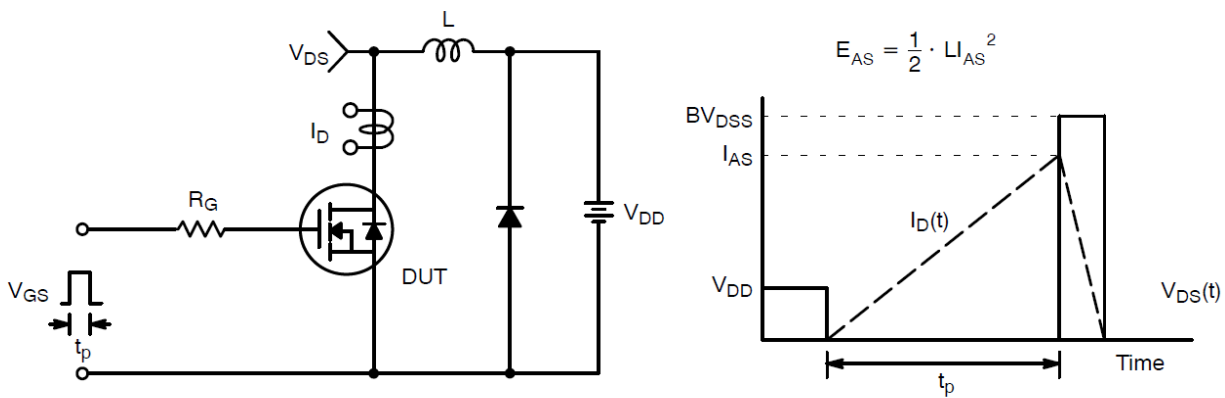

**Unclamped Inductive Switching Test Circuit & Waveforms**

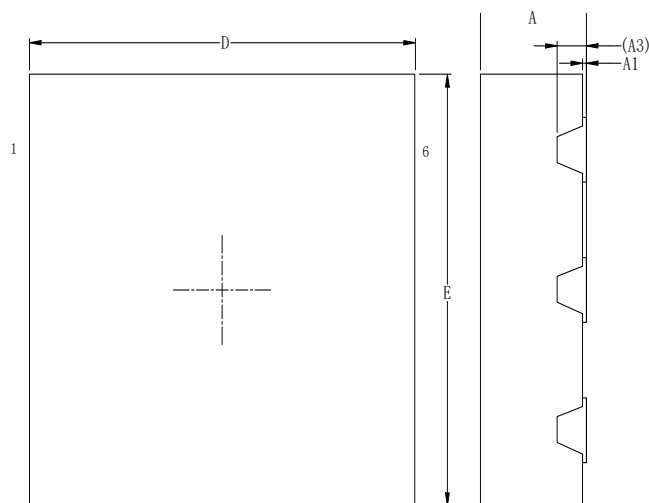
**●Dimensions (DFN2×2)**

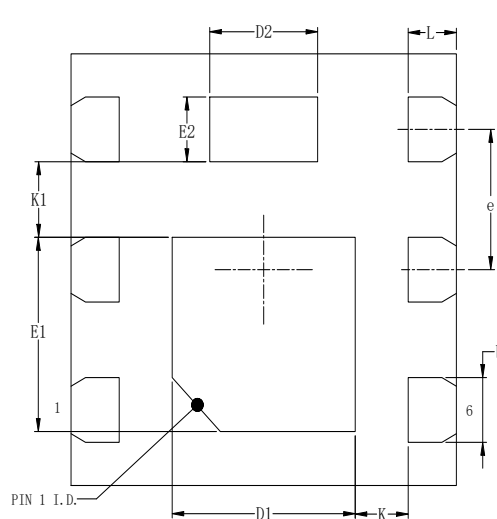
 TOP VIEW  
[顶视图]

 SIDE VIEW  
[侧视图]

BOTTOM VIEW

[背视图]

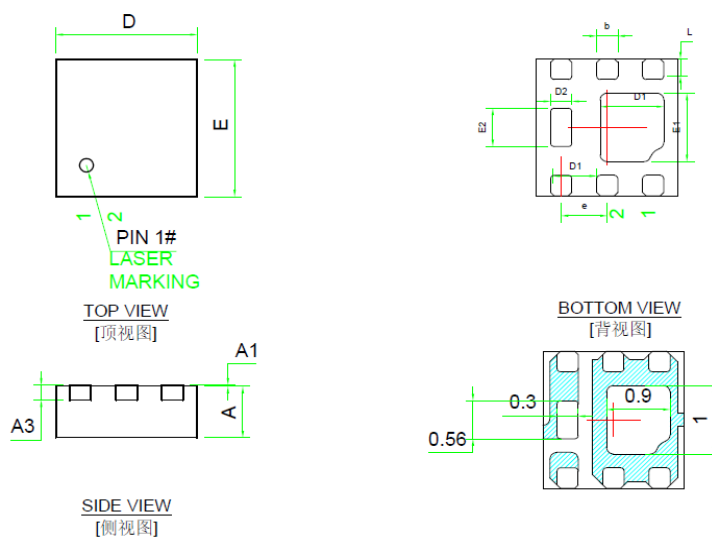
		SYMBOL	MIN	NOM	MAX
TOTAL THICKNESS		A	0.5	0.55	0.6
STAND OFF		A1	0	0.02	0.05
L/F THICKNESS		A3	0.152 REF		
LEAD WIDTH		b	0.25	0.3	0.35
BODY SIZE	X	D	1.9	2	2.1
	Y	E	1.9	2	2.1
LEAD PITCH		e	0.65 BSC		
EP SIZE	X	D1	0.85	0.95	1.05
		D2	0.46	0.56	0.66
	Y	E1	0.8	0.9	1
		E2	0.2	0.3	0.4
LEAD LENGTH		L	0.2	0.25	0.3
LEAD TIP TO EP EDGE		K	0.275 REF		
EP EDGE TO EP EDGE		K1	0.35 REF		

 TOP VIEW  
[顶视图]

 BOTTOM VIEW  
[背视图]

 SIDE VIEW  
[侧视图]

Symbol	Dimensions In Millimeters		
	Min	Nom	Max
A	0.700	0.750	0.800
A1	0.000	0.020	0.050
A3	0.203REF		
b	0.250	0.300	0.350
D	1.900	2.000	2.100
D1	0.850	0.900	0.950
D2	0.250	0.300	0.350
e	0.650BSC		
E	1.900	2.000	2.100
E1	0.950	1.000	1.050
E2	0.510	0.560	0.610
L	0.250	0.300	0.350



Disclaimer:

The information provided in this document is believed to be accurate and reliable. however, Shenzhen Core Control Electronics Technology Co., Ltd. does not assume any responsibility for the following consequences. Do not consider the use of such information or use beyond its scope.

The information mentioned in this document may be changed at any time without notice.

The products and information provided in this document do not infringe patents. Shenzhen Core Control Electronics Technology Co., Ltd. assumes no responsibility for any infringement of any other rights of third parties. The result of using such products and information.

This document is the second version issued on Dec. 10th, 2023. This document replaces all previously provided information.

 It is a registered trademark of Shenzhen Core Control Electronics Technology Co., Ltd.

Copyright © 2017 Shenzhen Core Control Electronics Technology Co., Ltd. all rights reserved.