

Features

- Protects four I/O lines
- Low capacitance (7pF) Max
- Low operating voltage: 3.3V
- Low clamping voltage
- Protects two lines in common and differential mode
- Complies with following standards:
 - IEC 61000-4-2 (ESD) immunity test
 - Air discharge: $\pm 30\text{kV}$
 - Contact discharge: $\pm 30\text{kV}$
 - IEC61000-4-5 (Lightning) 25A (8/20 μs)
- RoHS Compliant

Mechanical Characteristics

- Package: SOP-8
- Lead Finish: Matte Tin
- Case Material: "Green" Molding Compound.
- Moisture Sensitivity: Level 3 per J-STD-020
- Terminal Connections: See Diagram Below
- Shipping Qty : 2500pcs/7Inch Tape & Reel

Applications

- T1/E1 Line Cards
- T3/E3 and DS3 Interfaces
- STS-1 Interfaces
- 10/100/1000 BaseT Ethernet
- Set Top Box
- ISDN Interfaces
- Low Voltage Interfaces

Dimensions and Pin Configuration

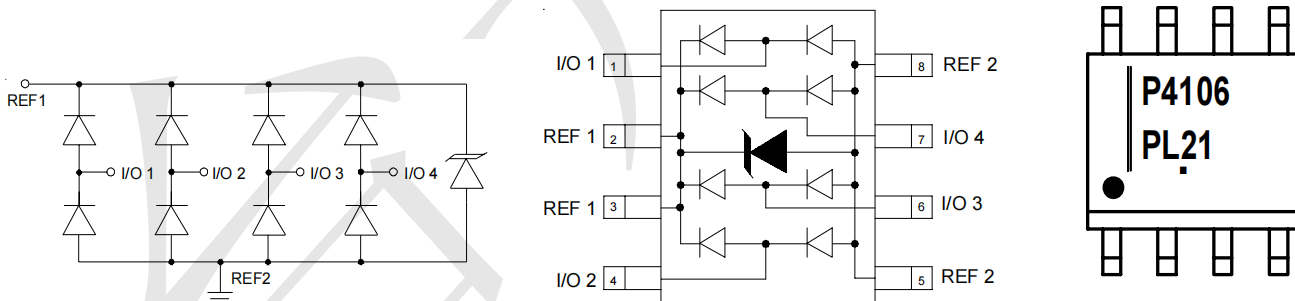

Absolute Maximum Ratings (Tamb=25°C unless otherwise specified)

Parameter	Symbol	Value	Unit
Peak Pulse Power(8/20μs)	Ppk	500	W
Peak Forward Voltage (If=1A, tp=8/20μs)	VFP	1.5	V
Lead Soldering Temperature	TL	260(10 sec.)	°C
Operating Temperature Range	TJ	-55 to +125	°C
Storage Temperature Range	Tstg	-55 to +150	°C

Electrical Characteristics (TA=25°C unless otherwise specified)

Parameter	Symbol	Min	Typ	Max	Unit	Test Condition
Reverse Working Voltage	VRWM			3.3	V	
Reverse Breakdown Voltage	VBR	4.5			V	IT = 1mA
Reverse Leakage Current	IR			2	μA	VRWM = 3.3V, T=25°C
Clamping Voltage	VC			8	V	I _{PP} = 1A (8 x 20μs pulse) Line to Ground
Clamping Voltage	VC			10	V	I _{PP} = 10A (8 x 20μs pulse) Line to Ground
Clamping Voltage	VC			15	V	I _{PP} = 25A (8 x 20μs pulse) Line to Ground
Junction Capacitance	CJ		5	7	pF	VR = 0V, f = 1MHz Between I/O pins and Ground
			3		pF	VR = 0V, f = 1MHz Between I/O pins



Typical Performance Characteristics ($T_A=25^\circ\text{C}$ unless otherwise Specified)

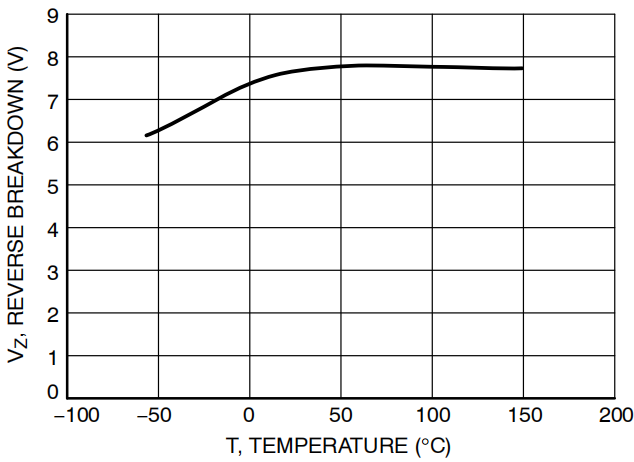

Figure 1. Reverse Breakdown versus Temperature

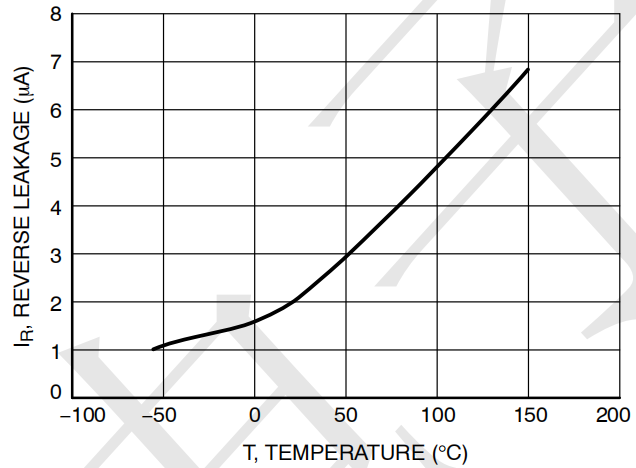

Figure 2. Reverse Leakage versus Temperature

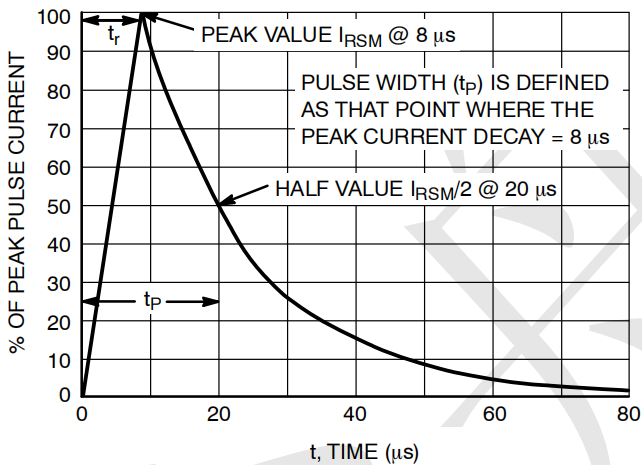

Figure 3. 8 x 20 µs Pulse Waveform

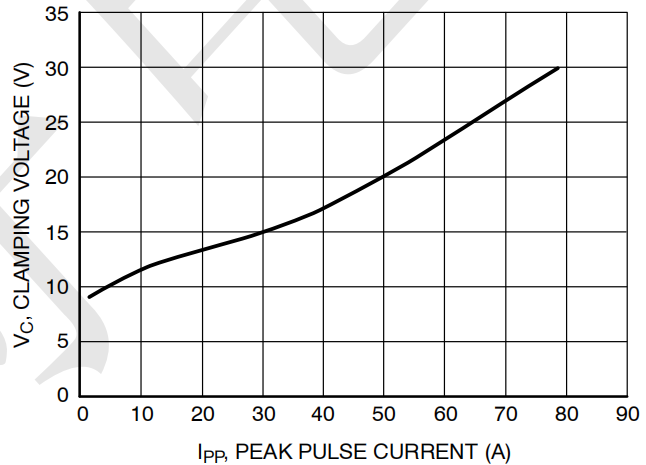
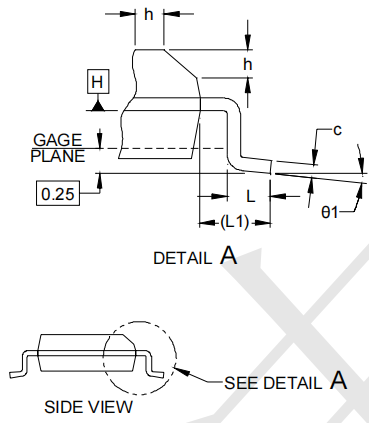
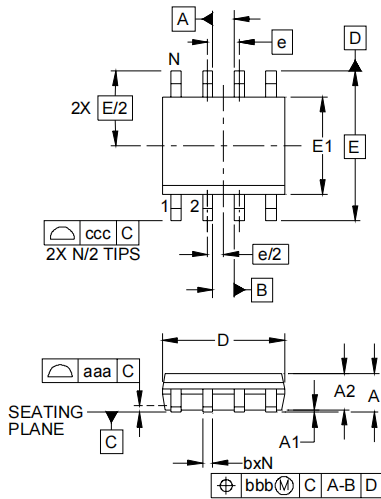

Figure 4. Clamping Voltage versus Peak Pulse Current



SOP-8 Package Outline Drawing



DIM	INCHES			MILLIMETERS		
	MIN	NOM	MAX	MIN	NOM	MAX
A	.053	-	.069	1.35	-	1.75
A1	.004	-	.010	0.10	-	0.25
A2	.049	-	.065	1.25	-	1.65
b	.012	-	.020	0.31	-	0.51
c	.007	-	.010	0.17	-	0.25
D	.189	.193	.197	4.80	4.90	5.00
E1	.150	.154	.157	3.80	3.90	4.00
E	.236 BSC			6.00 BSC		
e	.050 BSC			1.27 BSC		
h	.010	-	.020	0.25	-	0.50
L	.016	.028	.041	0.40	0.72	1.04
L1	(.041)			(1.04)		
N	8			8		
theta1	0° - 8°		0° - 8°			
aaa	.004			0.10		
bbb	.010			0.25		
ccc	.008			0.20		

Suggested Land Pattern

