

TLE208x, TLE208xA, TLE208xY EXCALIBUR HIGH-SPEED JFET-INPUT OPERATIONAL AMPLIFIERS

SLOS182B – FEBRUARY 1997 – REVISED JUNE 2001

- Direct Upgrades to TL05x, TL07x, and TL08x BiFET Operational Amplifiers
- Greater Than 2× Bandwidth (10 MHz) and 3× Slew Rate (45 V/μs) Than TL08x
- On-Chip Offset Voltage Trimming for Improved DC Performance
- Wider Supply Rails Increase Dynamic Signal Range to ±19 V

description

The TLE208x series of JFET-input operational amplifiers more than double the bandwidth and triple the slew rate of the TL07x and TL08x families of BiFET operational amplifiers. The TLE208x also have wider supply-voltage rails, increasing the dynamic-signal range for BiFET circuits to ±19 V. On-chip zener trimming of offset voltage yields precision grades for greater accuracy in dc-coupled applications. The TLE208x are pin-compatible with lower performance BiFET operational amplifiers for ease in improving performance in existing designs.

BiFET operational amplifiers offer the inherently higher input impedance of the JFET-input transistors, without sacrificing the output drive associated with bipolar amplifiers. This makes these amplifiers better suited for interfacing with high-impedance sensors or very low level ac signals. They also feature inherently better ac response than bipolar or CMOS devices having comparable power consumption.

Because BiFET operational amplifiers are designed for use with dual power supplies, care must be taken to observe common-mode input-voltage limits and output voltage swing when operating from a single supply. DC biasing of the input signal is required and loads should be terminated to a virtual ground node at mid-supply. Texas Instruments TLE2426 integrated virtual ground generator is useful when operating BiFET amplifiers from single supplies.

The TLE208x are fully specified at ±15 V and ±5 V. For operation in low-voltage and/or single-supply systems, Texas Instruments LinCMOS™ families of operational amplifiers (TLC- and TLV-prefix) are recommended. When moving from BiFET to CMOS amplifiers, particular attention should be paid to slew rate and bandwidth requirements and output loading.

For BiFET circuits requiring low noise and/or tighter dc precision, the TLE207x offer the same ac response as the TLE208x with more stringent dc and noise specifications.



Please be aware that an important notice concerning availability, standard warranty, and use in critical applications of Texas Instruments semiconductor products and disclaimers thereto appears at the end of this data sheet.

LinCMOS is a trademark of Texas Instruments.

PRODUCTION DATA information is current as of publication date. Products conform to specifications per the terms of Texas Instruments standard warranty. Production processing does not necessarily include testing of all parameters.



POST OFFICE BOX 655303 • DALLAS, TEXAS 75265

Copyright © 2001, Texas Instruments Incorporated

TLE208x, TLE208xA, TLE208xY EXCALIBUR HIGH-SPEED JFET-INPUT OPERATIONAL AMPLIFIERS

SLOS182B – FEBRUARY 1997 – REVISED JUNE 2001

TLE2081 AVAILABLE OPTIONS

T _A	V _{IOmax} AT 25°C	PACKAGED DEVICES				CHIP FORM (Y)
		SMALL OUTLINE (D)	CHIP CARRIER (FK)	CERAMIC DIP (JG)	PLASTIC DIP (P)	
0°C to 70°C	3 mV 6 mV	TLE2081ACD TLE2081CD	—	—	TLE2081ACP TLE2081CP	— TLE2081Y
–40°C to 85°C	3 mV 6 mV	TLE2081AID TLE2081ID	—	—	TLE2081AIP TLE2081IP	—
–55°C to 125°C	3 mV 6 mV	—	TLE2081AMFK TLE2081MFK	TLE2081AMJG TLE2081MJG	—	—

† The D packages are available taped and reeled. Add R suffix to device type (e.g., TLE2081ACDR).

‡ Chip forms are tested at T_A = 25°C only.

TLE2082 AVAILABLE OPTIONS

T _A	V _{IOmax} AT 25°C	PACKAGED DEVICES				CHIP FORM (Y)
		SMALL OUTLINE (D)	CHIP CARRIER (FK)	CERAMIC DIP (JG)	PLASTIC DIP (P)	
0°C to 70°C	4 mV 7 mV	TLE2082ACD TLE2082CD	—	—	TLE2082ACP TLE2082CP	—
–40°C to 85°C	4 mV 7 mV	TLE2082AID TLE2082ID	—	—	TLE2082AIP TLE2082IP	TLE2082Y
–55°C to 125°C	4 mV 7 mV	TLE2082AMD TLE2082MD	TLE2082AMFK TLE2082MFK	TLE2082AMJG TLE2082MJG	TLE2082AMP TLE2082MP	—

† The D packages are available taped and reeled. Add R suffix to device type (e.g., TLE2082ACDR).

‡ Chip forms are tested at T_A = 25°C only.

TLE2084 AVAILABLE OPTIONS

T _A	V _{IOmax} AT 25°C	PACKAGED DEVICES				CHIP FORM (Y)
		SMALL OUTLINE (DW)	CHIP CARRIER (FK)	CERAMIC DIP (J)	PLASTIC DIP (N)	
0°C to 70°C	4 mV 7 mV	TLE2084ACDW TLE2084CDW	—	—	TLE2084ACN TLE2084CN	— TLE2084Y
–55°C to 125°C	4 mV 7 mV	—	TLE2084AMFK TLE2084MFK	TLE2084AMJ TLE2084MJ	—	—

† The DW packages are available taped and reeled. Add R suffix to device type (e.g., TLE2084ACDWR).

‡ Chip forms are tested at T_A = 25°C only.



TLE208x, TLE208xA, TLE208xY EXCALIBUR HIGH-SPEED JFET-INPUT OPERATIONAL AMPLIFIERS

SLOS182B – FEBRUARY 1997 – REVISED JUNE 2001

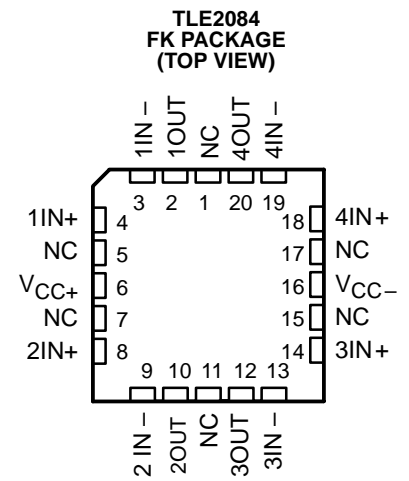
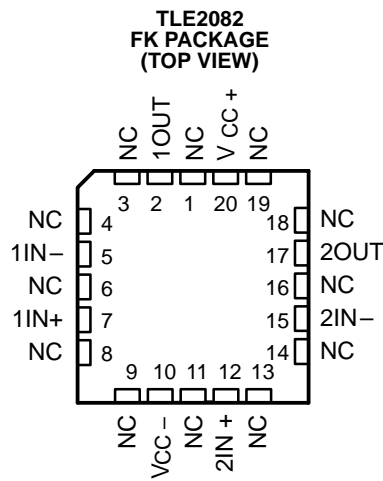
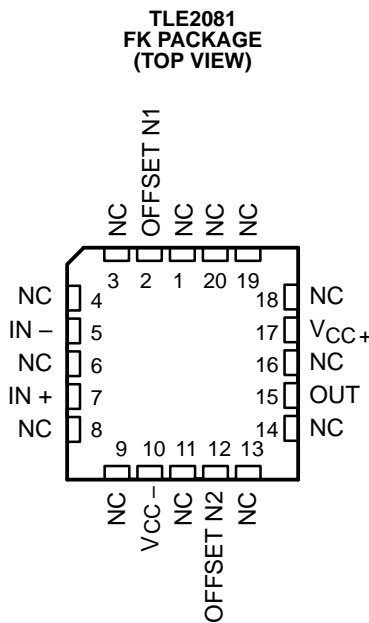
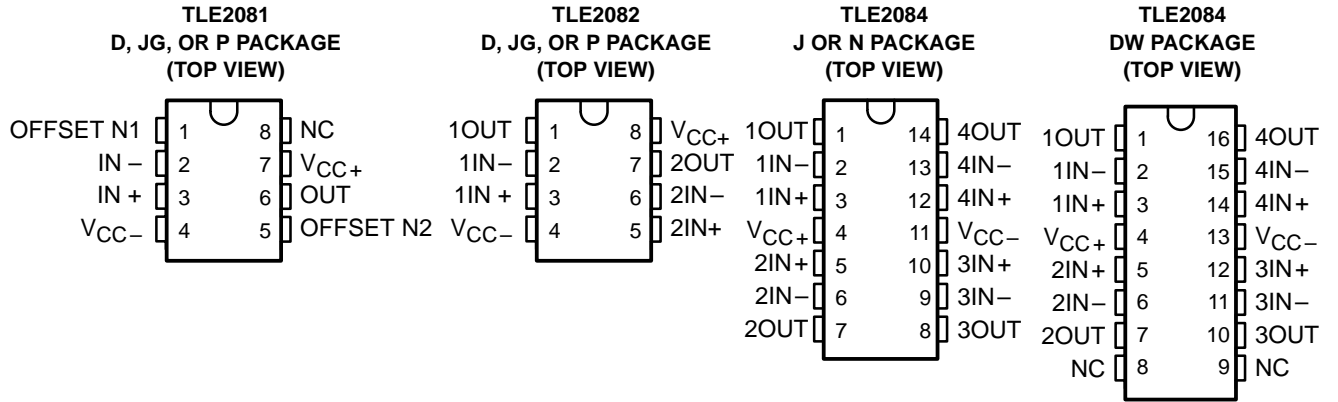

NC – No internal connection

symbol

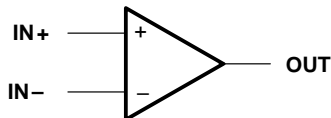

TLE208x, TLE208xA, TLE208xY EXCALIBUR HIGH-SPEED JFET-INPUT OPERATIONAL AMPLIFIERS

SLOS182B – FEBRUARY 1997 – REVISED JUNE 2001

TLE2081Y chip information

This chip, when properly assembled, displays characteristics similar to the TLE2081. Thermal compression or ultrasonic bonding may be used on the doped-aluminum bonding pads. Chips may be mounted with conductive epoxy or a gold-silicon preform.

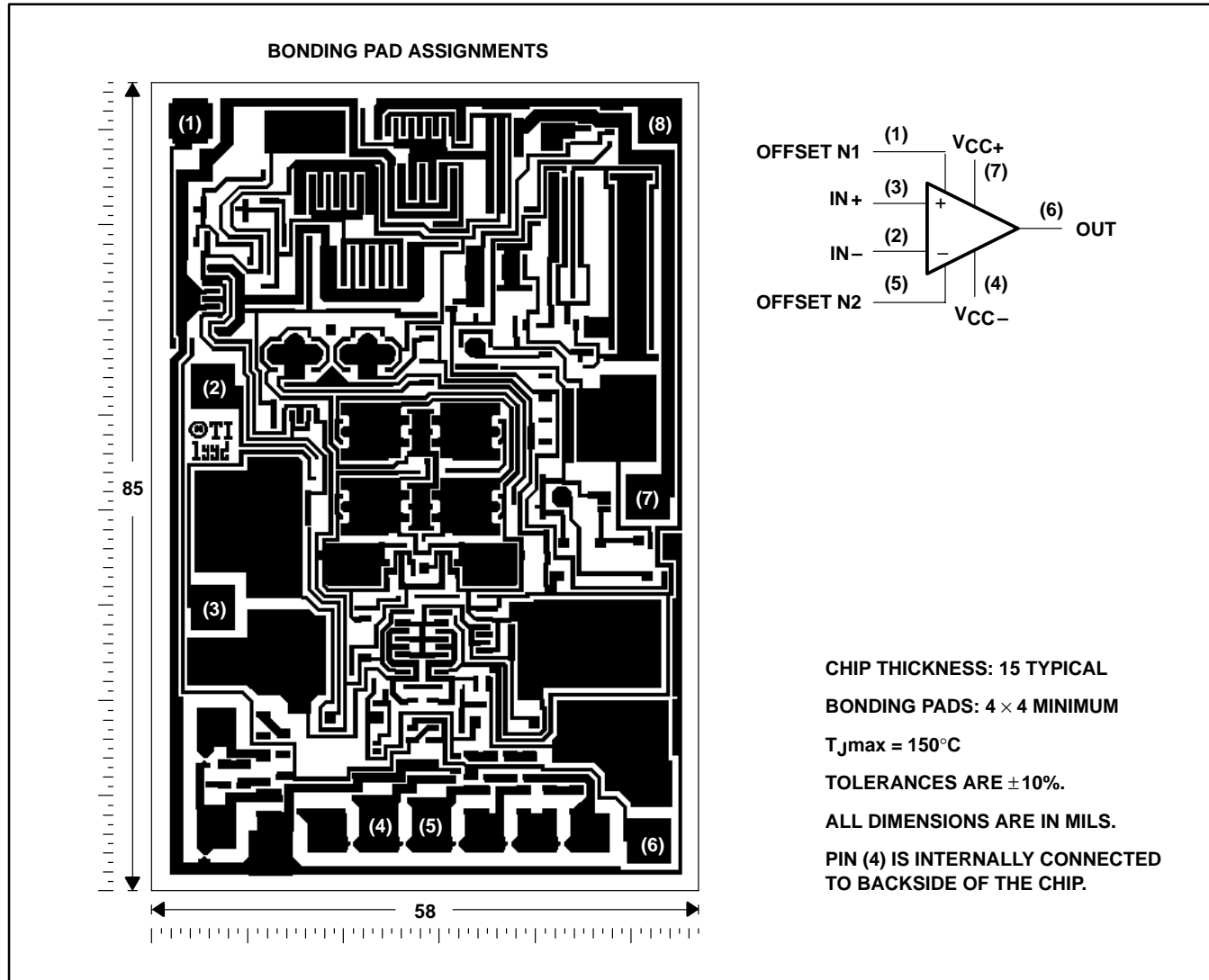

TLE208x, TLE208xA, TLE208xY EXCALIBUR HIGH-SPEED JFET-INPUT OPERATIONAL AMPLIFIERS

SLOS182B – FEBRUARY 1997 – REVISED JUNE 2001

TLE2082Y chip information

This chip, when properly assembled, displays characteristics similar to the TLE2082. Thermal compression or ultrasonic bonding may be used on the doped-aluminum bonding pads. Chips may be mounted with conductive epoxy or a gold-silicon preform.

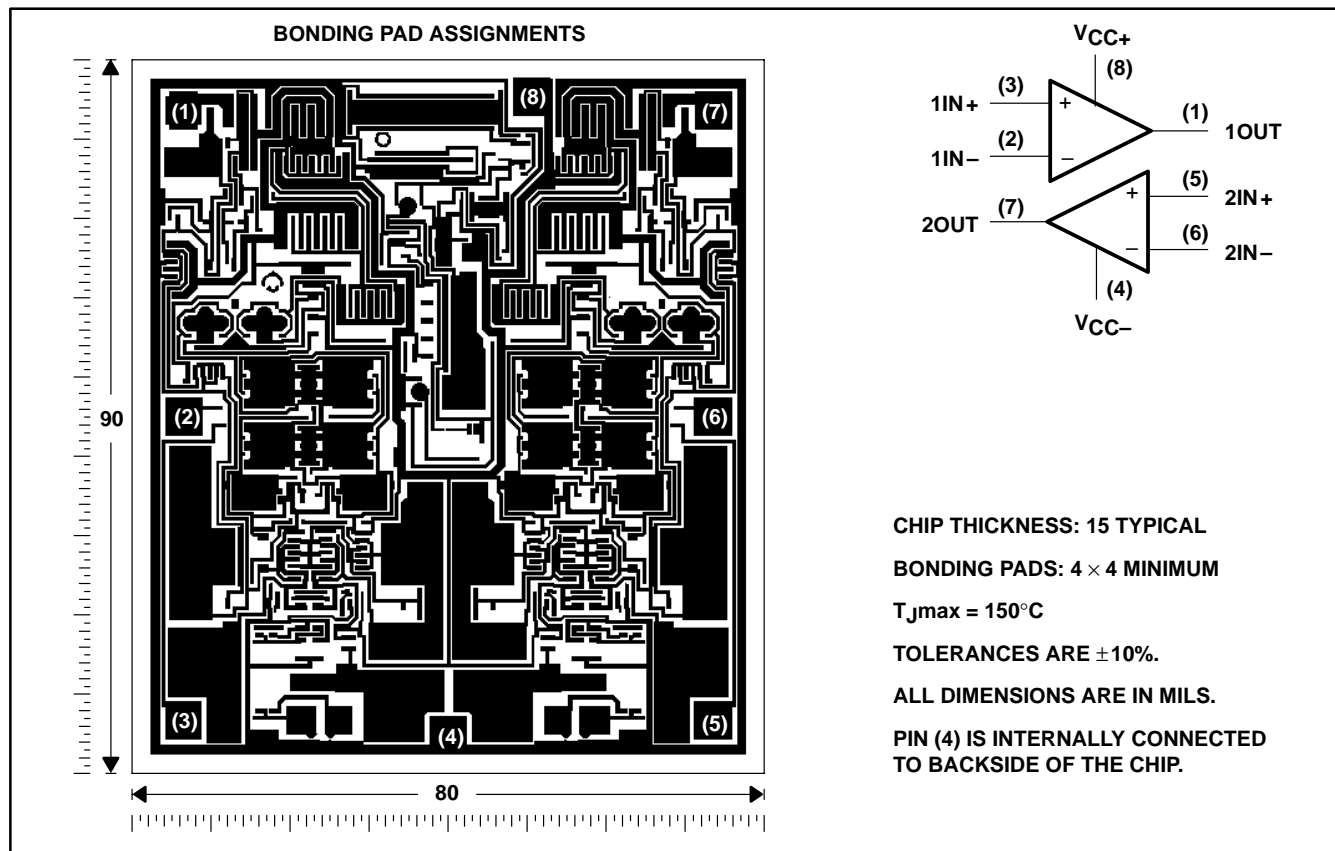

TLE208x, TLE208xA, TLE208xY EXCALIBUR HIGH-SPEED JFET-INPUT OPERATIONAL AMPLIFIERS

SLOS182B – FEBRUARY 1997 – REVISED JUNE 2001

TLE2084Y chip information

This chip, when properly assembled, displays characteristics similar to the TLE2084. Thermal compression or ultrasonic bonding may be used on the doped-aluminum bonding pads. Chips may be mounted with conductive epoxy or a gold-silicon preform.

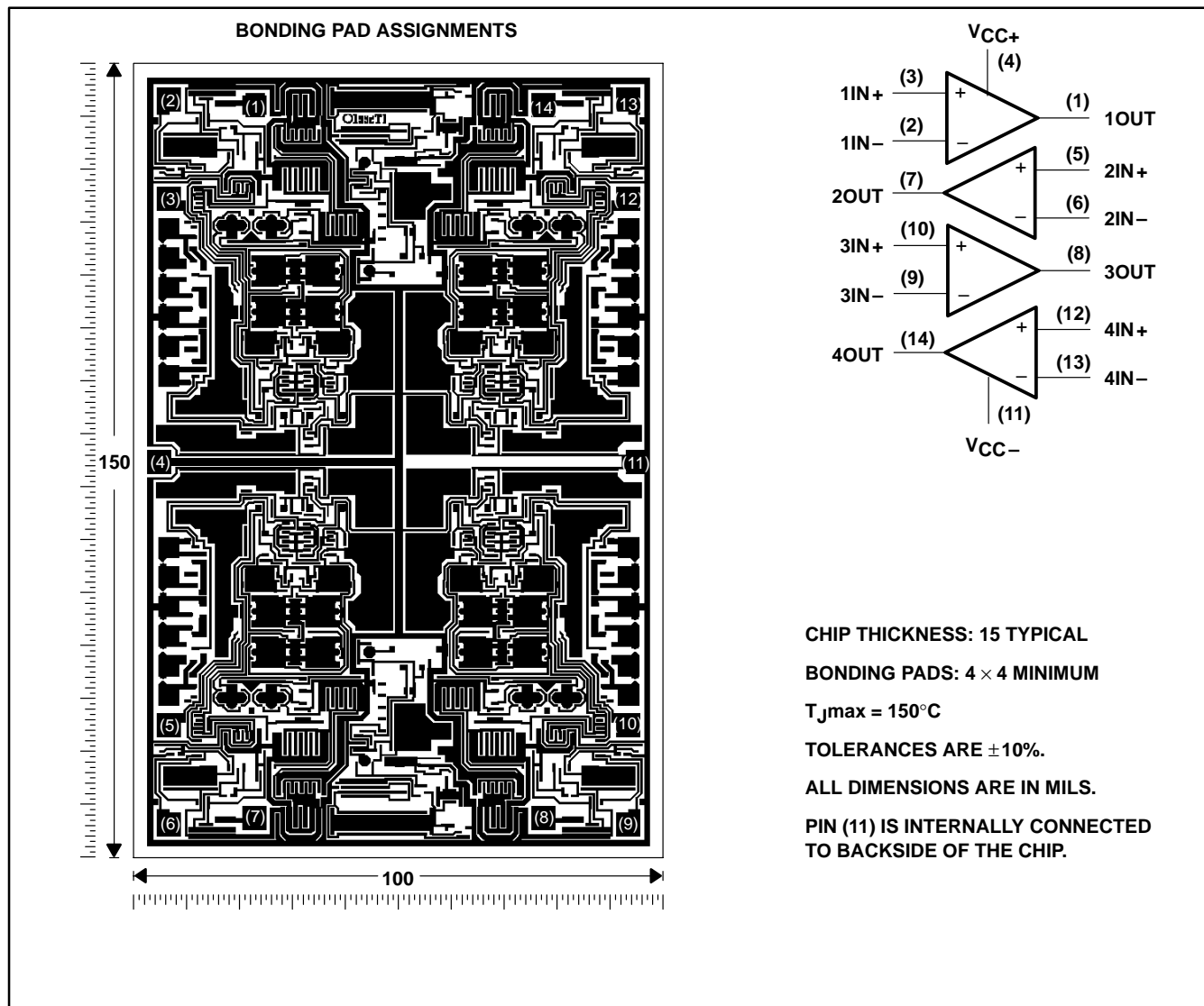

equivalent schematic (each channel)

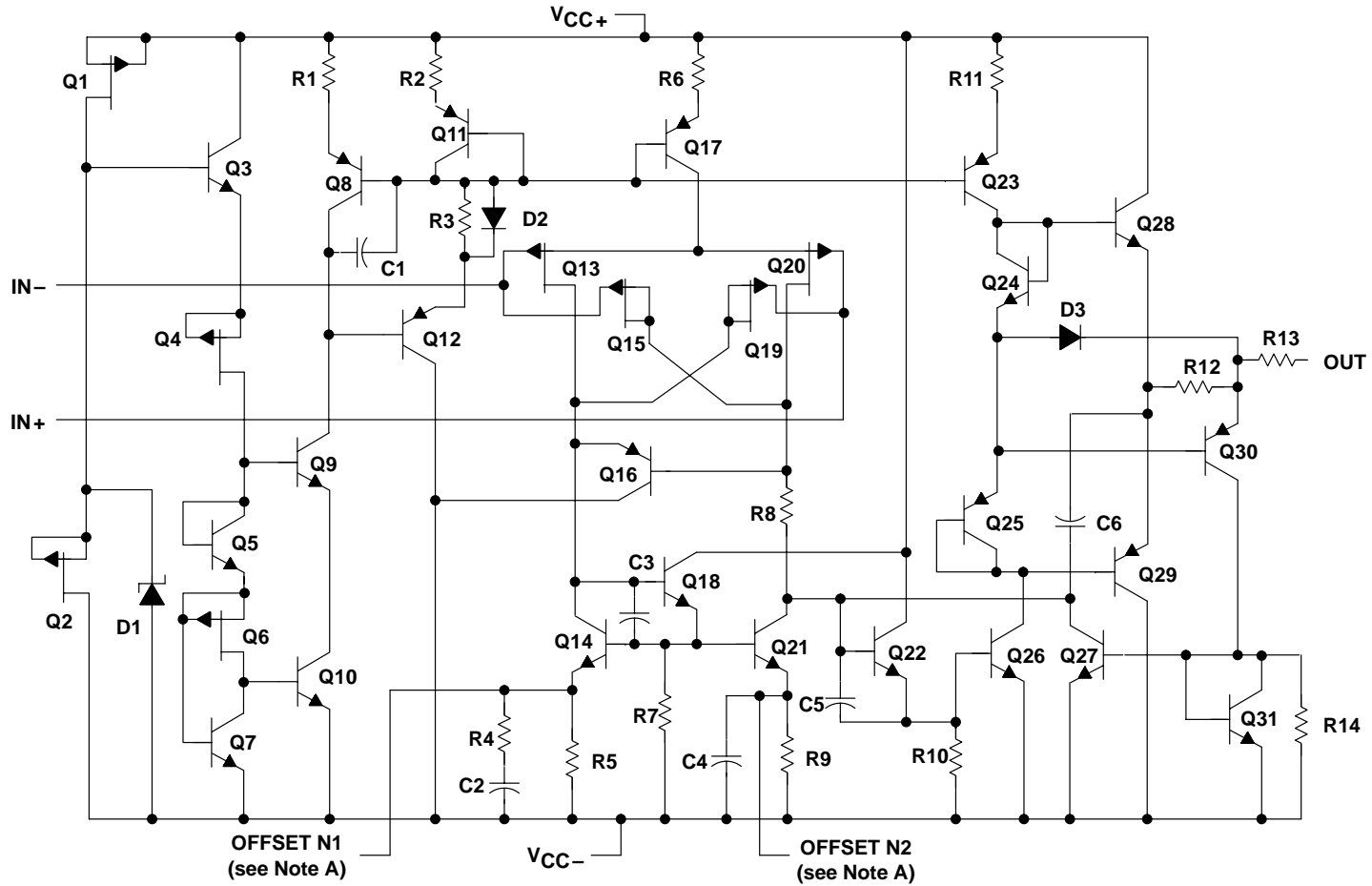

NOTE A: OFFSET N1 and OFFSET N2 are only available on the TLE2081x devices.

ACTUAL DEVICE COMPONENT COUNT			
COMPONENT	TLE2081	TLE2082	TLE2084
Transistors	33	57	114
Resistors	25	37	74
Diodes	8	5	10
Capacitors	6	11	22

TLE208x, TLE208xA, TLE208xY EXCALIBUR HIGH-SPEED JFET-INPUT OPERATIONAL AMPLIFIERS

SLOS182B – FEBRUARY 1997 – REVISED JUNE 2001

absolute maximum ratings over operating free-air temperature range (unless otherwise noted)†

Supply voltage, V_{CC+} (see Note 1)	19 V
Supply voltage, V_{CC-} (see Note 1)	-19 V
Differential input voltage range, V_{ID} (see Note 2)	V_{CC+} to V_{CC-}
Input voltage range, V_I (any input)	V_{CC+} to V_{CC-}
Input current, I_I (each input)	± 1 mA
Output current, I_O (each output)	± 80 mA
Total current into V_{CC+}	160 mA
Total current out of V_{CC-}	160 mA
Duration of short-circuit current at (or below) 25°C (see Note 3)	unlimited
Continuous total dissipation	See Dissipation Rating Table
Operating free-air temperature range, T_A : C suffix	0°C to 70°C
I suffix	-40°C to 85°C
M suffix	-55°C to 125°C
Storage temperature range	-65°C to 150°C
Case temperature for 60 seconds: FK package	260°C
Lead temperature 1,6 mm (1/16 inch) from case for 10 seconds: DW or N package	260°C
Lead temperature 1,6 mm (1/16 inch) from case for 60 seconds: J package	300°C

† Stresses beyond those listed under “absolute maximum ratings” may cause permanent damage to the device. These are stress ratings only, and functional operation of the device at these or any other conditions beyond those indicated under “recommended operating conditions” is not implied. Exposure to absolute-maximum-rated conditions for extended periods may affect device reliability.

- NOTES: 1. All voltage values, except differential voltages, are with respect to the midpoint between V_{CC+} and V_{CC-} .
 2. Differential voltages are at $IN+$ with respect to $IN-$.
 3. The output can be shorted to either supply. Temperatures and/or supply voltages must be limited to ensure that the maximum dissipation rate is not exceeded.

DISSIPATION RATING TABLE

PACKAGE	$T_A \leq 25^\circ\text{C}$	DERATING FACTOR ABOVE $T_A = 25^\circ\text{C}$	$T_A = 70^\circ\text{C}$	$T_A = 85^\circ\text{C}$	$T_A = 125^\circ\text{C}$
	POWER RATING		POWER RATING	POWER RATING	POWER RATING
D	725 mW	5.8 mW/°C	464 mW	377 mW	145 mW
DW	1025 mW	8.2 mW/°C	656 mW	533 mW	205 mW
FK	1375 mW	11.0 mW/°C	880 mW	715 mW	275 mW
J	1375 mW	11.0 mW/°C	880 mW	715 mW	275 mW
JG	1050 mW	8.4 mW/°C	672 mW	546 mW	210 mW
N	1150 mW	9.2 mW/°C	736 mW	598 mW	230 mW
P	1000 mW	8.0 mW/°C	640 mW	344 mW	200 mW

recommended operating conditions

	C SUFFIX		I SUFFIX		M SUFFIX		UNIT
	MIN	MAX	MIN	MAX	MIN	MAX	
Supply voltage, $V_{CC\pm}$	± 2.25	± 19	± 2.25	± 19	± 2.25	± 19	V
Common-mode input voltage, V_{IC}	$V_{CC\pm} = \pm 5$ V		-0.9	5	-0.8	5	V
	$V_{CC\pm} = \pm 15$ V		-10.9	15	-10.8	15	
Operating free-air temperature, T_A	0	70	-40	85	-55	125	°C



TLE208x, TLE208xA, TLE208xY
EXCALIBUR HIGH-SPEED JFET-INPUT
OPERATIONAL AMPLIFIERS

SLOS182B – FEBRUARY 1997 – REVISED JUNE 2001

TLE2081C electrical characteristics at specified free-air temperature, $V_{CC\pm} = \pm 5$ V (unless otherwise noted)

PARAMETER	TEST CONDITIONS	T_A †	TLE2081C			TLE2081AC			UNIT
			MIN	TYP	MAX	MIN	TYP	MAX	
V_{IO} Input offset voltage	$V_{IC} = 0,$ $R_S = 50 \Omega$	$V_O = 0,$	25°C	0.34	6	0.3	3	mV	
			Full range	8			5		
α_{VIO} Temperature coefficient of input offset voltage	$V_{IC} = 0,$ $R_S = 50 \Omega$	$V_O = 0,$	Full range	3.2	29	3.2	29	$\mu V/^\circ C$	
I_{IO} Input offset current			$V_{IC} = 0,$ See Figure 4	$V_O = 0,$	25°C	5	100	5	100
I_{IB} Input bias current	See Figure 4	$V_O = 0,$			Full range	1.4			1.4
			25°C	15	175	15	175	nA	
V_{ICR} Common-mode input voltage range	$R_S = 50 \Omega$	$V_O = 0,$	25°C	5 to -1	5 to -1.9	5 to -1	5 to -1.9	V	
			Full range	5 to -0.9			5 to -0.9		
V_{OM+} Maximum positive peak output voltage swing	$I_O = -200 \mu A$	$V_O = 0,$	25°C	3.8	4.1	3.8	4.1	V	
			Full range	3.7			3.7		
	$I_O = -2$ mA	$V_O = 0,$	25°C	3.5	3.9	3.5	3.9		
			Full range	3.4			3.4		
	$I_O = -20$ mA	$V_O = 0,$	25°C	1.5	2.3	1.5	2.3		
			Full range	1.5			1.5		
V_{OM-} Maximum negative peak output voltage swing	$I_O = 200 \mu A$	$V_O = 0,$	25°C	-3.5	-4.2	-3.5	-4.2	V	
			Full range	-3.4			-3.4		
	$I_O = 2$ mA	$V_O = 0,$	25°C	-3.7	-4.1	-3.7	-4.1		
			Full range	-3.6			-3.6		
	$I_O = 20$ mA	$V_O = 0,$	25°C	-1.5	-2.4	-1.5	-2.4		
			Full range	-1.5			-1.5		
A_{VD} Large-signal differential voltage amplification	$V_O = \pm 2.3$ V	$R_L = 600 \Omega$	25°C	80	91	80	91	dB	
			Full range	79			79		
		$R_L = 2$ k Ω	25°C	90	100	90	100		
			Full range	89			89		
		$R_L = 10$ k Ω	25°C	95	106	95	106		
			Full range	94			94		
r_i Input resistance	$V_{IC} = 0$	25°C	10^{12}			10^{12}		Ω	
c_i Input capacitance	$V_{IC} = 0,$ See Figure 5	Common mode	25°C	11			11	pF	
		Differential	25°C	2.5			2.5		
z_o Open-loop output impedance	$f = 1$ MHz	25°C	80			80		Ω	
CMRR Common-mode rejection ratio	$V_{IC} = V_{ICRmin},$ $V_O = 0,$ $R_S = 50 \Omega$	25°C	70	89	70	89	dB		
		Full range	68			68			
k_{SVR} Supply-voltage rejection ratio ($\Delta V_{CC\pm} / \Delta V_{IO}$)	$V_{CC\pm} = \pm 5$ V to ± 15 V, $V_O = 0,$ $R_S = 50 \Omega$	25°C	82	99	82	99	dB		
		Full range	80			80			

† Full range is 0°C to 70°C.



TLE208x, TLE208xA, TLE208xY
EXCALIBUR HIGH-SPEED JFET-INPUT
OPERATIONAL AMPLIFIERS

SLOS182B – FEBRUARY 1997 – REVISED JUNE 2001

TLE2081C electrical characteristics at specified free-air temperature, $V_{CC\pm} = \pm 5\text{ V}$ (unless otherwise noted) (continued)

PARAMETER	TEST CONDITIONS	T_A †	TLE2081C			TLE2081AC			UNIT
			MIN	TYP	MAX	MIN	TYP	MAX	
I_{CC} Supply current	$V_O = 0$, No load	25°C	1.35	1.6	2.2	1.35	1.6	2.2	mA
		Full range			2.2			2.2	
I_{OS} Short-circuit output current	$V_O = 0$	25°C	$V_{ID} = 1\text{ V}$			-35			mA
			$V_{ID} = -1\text{ V}$			45			

† Full range is 0°C to 70°C.

TLE2081C operating characteristics at specified free-air temperature, $V_{CC\pm} = \pm 5\text{ V}$

PARAMETER	TEST CONDITIONS	T_A †	TLE2081C			TLE2081AC			UNIT	
			MIN	TYP	MAX	MIN	TYP	MAX		
SR+ Positive slew rate	$V_{O(PP)} = \pm 2.3\text{ V}$, $A_{VD} = -1$, $R_L = 2\text{ k}\Omega$, $C_L = 100\text{ pF}$, See Figure 1	25°C	35			35			V/ μ s	
		Full range	23			23				
SR- Negative slew rate		25°C	38			38			V/ μ s	
		Full range	23			23				
t_s Settling time	$A_{VD} = -1$, 2-V step, $R_L = 1\text{ k}\Omega$, $C_L = 100\text{ pF}$	25°C	To 10 mV			0.25			μ s	
			To 1 mV			0.4				
V_n Equivalent input noise voltage	$R_S = 20\ \Omega$, See Figure 3	25°C	$f = 10\text{ Hz}$			28			nV/ $\sqrt{\text{Hz}}$	
			$f = 10\text{ kHz}$			11.6				
$V_{N(PP)}$ Peak-to-peak equivalent input noise voltage		$f = 10\text{ Hz to } 10\text{ kHz}$	25°C	6			6			μ V
				$f = 0.1\text{ Hz to } 10\text{ Hz}$			0.6			
I_n Equivalent input noise current	$V_{IC} = 0$, $f = 10\text{ kHz}$	25°C	2.8			2.8			fA/ $\sqrt{\text{Hz}}$	
THD + N Total harmonic distortion plus noise	$V_{O(PP)} = 5\text{ V}$, $A_{VD} = 10$, $f = 1\text{ kHz}$, $R_L = 2\text{ k}\Omega$, $R_S = 25\ \Omega$	25°C	0.013%			0.013%				
B_1 Unity-gain bandwidth	$V_I = 10\text{ mV}$, $R_L = 2\text{ k}\Omega$, $C_L = 25\text{ pF}$, See Figure 2	25°C	9.4			9.4			MHz	
B_{OM} Maximum output-swing bandwidth	$V_{O(PP)} = 4\text{ V}$, $A_{VD} = -1$, $R_L = 2\text{ k}\Omega$, $C_L = 25\text{ pF}$	25°C	2.8			2.8			MHz	
ϕ_m Phase margin at unity gain	$V_I = 10\text{ mV}$, $R_L = 2\text{ k}\Omega$, $C_L = 25\text{ pF}$, See Figure 2	25°C	56°			56°				

† Full range is 0°C to 70°C.



TLE208x, TLE208xA, TLE208xY
EXCALIBUR HIGH-SPEED JFET-INPUT
OPERATIONAL AMPLIFIERS

SLOS182B – FEBRUARY 1997 – REVISED JUNE 2001

TLE2081C electrical characteristics at specified free-air temperature, $V_{CC\pm} = \pm 15\text{ V}$ (unless otherwise noted)

PARAMETER	TEST CONDITIONS	T_A †	TLE2081C			TLE2081AC			UNIT	
			MIN	TYP	MAX	MIN	TYP	MAX		
V_{IO} Input offset voltage	$V_{IC} = 0, V_O = 0, R_S = 50\ \Omega$	25°C	0.49	6		0.47	3	mV		
		Full range			8		5			
α_{VIO} Temperature coefficient of input offset voltage		Full range	3.2	29		3.2	29	$\mu\text{V}/^\circ\text{C}$		
I_{IO} Input offset current	$V_{IC} = 0, V_O = 0, \text{See Figure 4}$	25°C	6	100		6	100	nA		
		Full range		1.4			1.4			
I_{IB} Input bias current		25°C	20	175		20	175	nA		
		Full range		5			5			
V_{ICR} Common-mode input voltage range	$R_S = 50\ \Omega$	25°C	15 to -11	15 to -11.9		15 to -11	15 to -11.9	V		
		Full range	15 to -10.9			15 to -10.9				
V_{OM+} Maximum positive peak output voltage swing	$I_O = -200\ \mu\text{A}$	25°C	13.8	14.1		13.8	14.1	V		
		Full range	13.7			13.7				
	$I_O = -2\ \text{mA}$	25°C	13.5	13.9		13.5	13.9			
		Full range	13.4			13.4				
	$I_O = -20\ \text{mA}$	25°C	11.5	12.3		11.5	12.3			
		Full range	11.5			11.5				
V_{OM-} Maximum negative peak output voltage swing	$I_O = 200\ \mu\text{A}$	25°C	-13.8	-14.2		-13.8	-14.2	V		
		Full range	-13.7			-13.7				
	$I_O = 2\ \text{mA}$	25°C	-13.5	-14		-13.5	-14			
		Full range	-13.4			-13.4				
	$I_O = 20\ \text{mA}$	25°C	-11.5	-12.4		-11.5	-12.4			
		Full range	-11.5			-11.5				
A_{VD} Large-signal differential voltage amplification	$V_O = \pm 10\ \text{V}$	$R_L = 600\ \Omega$	25°C	80	96		80	96	dB	
			Full range	79			79			
		$R_L = 2\ \text{k}\Omega$	25°C	90	109		90	109		
			Full range	89			89			
		$R_L = 10\ \text{k}\Omega$	25°C	95	118		95	118		
			Full range	94			94			
r_i Input resistance	$V_{IC} = 0$	25°C	10^{12}			10^{12}			Ω	
c_i Input capacitance	$V_{IC} = 0, \text{See Figure 5}$	Common mode	25°C	7.5			7.5			pF
		Differential	25°C	2.5			2.5			
z_o Open-loop output impedance	$f = 1\ \text{MHz}$	25°C	80			80			Ω	
CMRR Common-mode rejection ratio	$V_{IC} = V_{ICR\text{min}}, V_O = 0, R_S = 50\ \Omega$	25°C	80	98		80	98	dB		
		Full range	79			79				
k_{SVR} Supply-voltage rejection ratio ($\Delta V_{CC\pm}/\Delta V_{IO}$)	$V_{CC\pm} = \pm 5\ \text{V to } \pm 15\ \text{V}, V_O = 0, R_S = 50\ \Omega$	25°C	82	99		82	99	dB		
		Full range	80			81				

† Full range is 0°C to 70°C.



TLE208x, TLE208xA, TLE208xY
EXCALIBUR HIGH-SPEED JFET-INPUT
OPERATIONAL AMPLIFIERS

SLOS182B – FEBRUARY 1997 – REVISED JUNE 2001

TLE2081C electrical characteristics at specified free-air temperature, $V_{CC\pm} = \pm 15\text{ V}$ (unless otherwise noted) (continued)

PARAMETER	TEST CONDITIONS	T_A †	TLE2081C			TLE2081AC			UNIT
			MIN	TYP	MAX	MIN	TYP	MAX	
I_{CC} Supply current	$V_O = 0$, No load	25°C	1.35	1.7	2.2	1.35	1.7	2.2	mA
		Full range	2.2			2.2			
I_{OS} Short-circuit output current	$V_O = 0$	25°C	$V_{ID} = 1\text{ V}$	-30	-45	-30	-45	mA	
			$V_{ID} = -1\text{ V}$	30	48	30	48		

† Full range is 0°C to 70°C.

TLE2081C operating characteristics at specified free-air temperature, $V_{CC\pm} = \pm 15\text{ V}$

PARAMETER	TEST CONDITIONS	T_A †	TLE2081C			TLE2081AC			UNIT	
			MIN	TYP	MAX	MIN	TYP	MAX		
SR+ Positive slew rate	$V_{O(PP)} = 10\text{ V}$, $A_{VD} = -1$, $R_L = 2\text{ k}\Omega$, $C_L = 100\text{ pF}$, See Figure 1	25°C	30	40		30	40	V/ μ s		
		Full range	27			27				
SR- Negative slew rate		25°C	30	45		30	45	V/ μ s		
		Full range	27			27				
t_s Settling time	$A_{VD} = -1$, 10-V step, $R_L = 1\text{ k}\Omega$, $C_L = 100\text{ pF}$	25°C	To 10 mV	0.4			0.4			μ s
			To 1 mV	1.5			1.5			
V_n Equivalent input noise voltage	$R_S = 20\ \Omega$, See Figure 3	25°C	f = 10 Hz	28			28			nV/ $\sqrt{\text{Hz}}$
			f = 10 kHz	11.6			11.6			
$V_{N(PP)}$ Peak-to-peak equivalent input noise voltage		25°C	f = 10 Hz to 10 kHz	6			6			μ V
			f = 0.1 Hz to 10 Hz	0.6			0.6			
I_n Equivalent input noise current	$V_{IC} = 0$, f = 10 kHz	25°C	2.8			2.8			fA/ $\sqrt{\text{Hz}}$	
THD + N Total harmonic distortion plus noise	$V_{O(PP)} = 20\text{ V}$, $A_{VD} = 10$, f = 1 kHz, $R_L = 2\text{ k}\Omega$, $R_S = 25\ \Omega$	25°C	0.008%			0.008%				
B_1 Unity-gain bandwidth	$V_I = 10\text{ mV}$, $R_L = 2\text{ k}\Omega$, $C_L = 25\text{ pF}$, See Figure 2	25°C	8	10		8	10	MHz		
B_{OM} Maximum output-swing bandwidth	$V_{O(PP)} = 20\text{ V}$, $A_{VD} = -1$, $R_L = 2\text{ k}\Omega$, $C_L = 25\text{ pF}$	25°C	478	637		478	637	kHz		
ϕ_m Phase margin at unity gain	$V_I = 10\text{ mV}$, $R_L = 2\text{ k}\Omega$, $C_L = 25\text{ pF}$, See Figure 2	25°C	57°			57°				

† Full range is 0°C to 70°C.



TLE208x, TLE208xA, TLE208xY
EXCALIBUR HIGH-SPEED JFET-INPUT
OPERATIONAL AMPLIFIERS

SLOS182B – FEBRUARY 1997 – REVISED JUNE 2001

TLE2081I electrical characteristics at specified free-air temperature, $V_{CC\pm} = \pm 5\text{ V}$ (unless otherwise noted)

PARAMETER	TEST CONDITIONS	T_A †	TLE2081I			TLE2081AI			UNIT	
			MIN	TYP	MAX	MIN	TYP	MAX		
V_{IO} Input offset voltage	$V_{IC} = 0,$ $R_S = 50\ \Omega,$ $V_O = 0,$	25°C	0.34		6	0.3		3	mV	
		Full range			7.6			5.6		
α_{VIO} Temperature coefficient of input offset voltage		Full range	3.2		29	3.2		29	$\mu\text{V}/^\circ\text{C}$	
I_{IO} Input offset current	$V_{IC} = 0,$ $V_O = 0,$ See Figure 4	25°C	5		100	5		100	pA	
		Full range			5			5	nA	
I_{IB} Input bias current		25°C	15		175	15		175	pA	
		Full range			10			10	nA	
V_{ICR} Common-mode input voltage range	$R_S = 50\ \Omega$	25°C	5 to -1	5 to -1.9		5 to -1	5 to -1.9		V	
		Full range	5 to -0.8			5 to -0.8				
V_{OM+} Maximum positive peak output voltage swing	$I_O = -200\ \mu\text{A}$	25°C	3.8		4.1	3.8		4.1	V	
		Full range			3.7			3.7		
	$I_O = -2\ \text{mA}$	25°C	3.5		3.9	3.5		3.9		
		Full range			3.4			3.4		
	$I_O = -20\ \text{mA}$	25°C	1.5		2.3	1.5		2.3		
		Full range			1.5			1.5		
V_{OM-} Maximum negative peak output voltage swing	$I_O = 200\ \mu\text{A}$	25°C	-3.8		-4.2	-3.8		-4.2	V	
		Full range			-3.7			-3.7		
	$I_O = 2\ \text{mA}$	25°C	-3.5		-4.1	-3.5		-4.1		
		Full range			-3.4			-3.4		
	$I_O = 20\ \text{mA}$	25°C	-1.5		-2.4	-1.5		-2.4		
		Full range			-1.5			-1.5		
A_{VD} Large-signal differential voltage amplification	$V_O = \pm 2.3\ \text{V}$	$R_L = 600\ \Omega$	25°C	80		91	80		91	dB
			Full range			79			79	
		$R_L = 2\ \text{k}\Omega$	25°C	90		100	90		100	
			Full range			89			89	
		$R_L = 10\ \text{k}\Omega$	25°C	95		106	95		106	
			Full range			94			94	
r_i Input resistance	$V_{IC} = 0$	25°C	10^{12}			10^{12}			Ω	
c_i Input capacitance	$V_{IC} = 0,$ See Figure 5	Common mode	25°C	11			11			pF
		Differential	25°C	2.5			2.5			
z_o Open-loop output impedance	$f = 1\ \text{MHz}$	25°C	80			80			Ω	
CMRR Common-mode rejection ratio	$V_{IC} = V_{ICRmin},$ $V_O = 0,$ $R_S = 50\ \Omega$	25°C	70		89	70		89	dB	
		Full range			68			68		
k_{SVR} Supply-voltage rejection ratio ($\Delta V_{CC\pm}/\Delta V_{IO}$)	$V_{CC\pm} = \pm 5\ \text{V}$ to $\pm 15\ \text{V},$ $V_O = 0,$ $R_S = 50\ \Omega$	25°C	82		99	82		99	dB	
		Full range			80			80		

† Full range is -40°C to 85°C .



TLE208x, TLE208xA, TLE208xY EXCALIBUR HIGH-SPEED JFET-INPUT OPERATIONAL AMPLIFIERS

SLOS182B – FEBRUARY 1997 – REVISED JUNE 2001

TLE2081I electrical characteristics at specified free-air temperature, $V_{CC\pm} = \pm 5\text{ V}$ (unless otherwise noted) (continued)

PARAMETER	TEST CONDITIONS	T_A †	TLE2081I			TLE2081AI			UNIT
			MIN	TYP	MAX	MIN	TYP	MAX	
I_{CC} Supply current	$V_O = 0$, No load	25°C	1.35	1.6	2.2	1.35	1.6	2.2	mA
		Full range	2.2			2.2			
I_{OS} Short-circuit output current	$V_O = 0$	$V_{ID} = 1\text{ V}$	-35			-35			mA
		$V_{ID} = -1\text{ V}$	45			45			

† Full range is -40°C to 85°C .

TLE2081I operating characteristics at specified free-air temperature, $V_{CC\pm} = \pm 5\text{ V}$

PARAMETER	TEST CONDITIONS	T_A †	TLE2081I			TLE2081AI			UNIT
			MIN	TYP	MAX	MIN	TYP	MAX	
SR+ Positive slew rate	$V_{O(PP)} = \pm 2.3\text{ V}$, $A_{VD} = -1$, $R_L = 2\text{ k}\Omega$, $C_L = 100\text{ pF}$, See Figure 1	25°C	35			35			$\text{V}/\mu\text{s}$
		Full range	22			22			
SR- Negative slew rate		25°C	38			38			$\text{V}/\mu\text{s}$
		Full range	22			22			
t_s Settling time	$A_{VD} = -1$, 2-V step, $R_L = 1\text{ k}\Omega$, $C_L = 100\text{ pF}$	To 10 mV	0.25			0.25			μs
		To 1 mV	0.4			0.4			
V_n Equivalent input noise voltage	$R_S = 20\ \Omega$, See Figure 3	f = 10 Hz	28			28			$\text{nV}/\sqrt{\text{Hz}}$
		f = 10 kHz	11.6			11.6			
$V_{N(PP)}$ Peak-to-peak equivalent input noise voltage		f = 10 Hz to 10 kHz	6			6			μV
		f = 0.1 Hz to 10 Hz	0.6			0.6			
I_n Equivalent input noise current	$V_{IC} = 0$, f = 10 kHz	25°C	2.8			2.8			$\text{fA}/\sqrt{\text{Hz}}$
THD + N Total harmonic distortion plus noise	$V_{O(PP)} = 5\text{ V}$, $A_{VD} = 10$, f = 1 kHz, $R_L = 2\text{ k}\Omega$, $R_S = 25\ \Omega$	25°C	0.013%			0.013%			
B_1 Unity-gain bandwidth	$V_I = 10\text{ mV}$, $R_L = 2\text{ k}\Omega$, $C_L = 25\text{ pF}$, See Figure 2	25°C	9.4			9.4			MHz
B_{OM} Maximum output-swing bandwidth	$V_{O(PP)} = 4\text{ V}$, $A_{VD} = -1$, $R_L = 2\text{ k}\Omega$, $C_L = 25\text{ pF}$	25°C	2.8			2.8			MHz
ϕ_m Phase margin at unity gain	$V_I = 10\text{ mV}$, $R_L = 2\text{ k}\Omega$, $C_L = 25\text{ pF}$, See Figure 2	25°C	56°			56°			

† Full range is -40°C to 85°C .



TLE208x, TLE208xA, TLE208xY
EXCALIBUR HIGH-SPEED JFET-INPUT
OPERATIONAL AMPLIFIERS

SLOS182B – FEBRUARY 1997 – REVISED JUNE 2001

TLE20811 electrical characteristics at specified free-air temperature, $V_{CC\pm} = \pm 15$ V (unless otherwise noted)

PARAMETER	TEST CONDITIONS	T_A †	TLE20811			TLE2081AI			UNIT	
			MIN	TYP	MAX	MIN	TYP	MAX		
V_{IO} Input offset voltage	$V_{IC} = 0,$ $R_S = 50 \Omega,$ $V_O = 0,$	25°C	0.49	6		0.47	3	mV		
		Full range			7.6		5.6			
αV_{IO} Temperature coefficient of input offset voltage		Full range	3.2	29		3.2	29	$\mu V/^\circ C$		
I_{IO} Input offset current	$V_{IC} = 0,$ $V_O = 0,$ See Figure 4	25°C	6	100		6	100	pA		
		Full range		5			5	nA		
I_{IB} Input bias current		25°C	20	175		20	175	pA		
		Full range		10			10	nA		
V_{ICR} Common-mode input voltage range	$R_S = 50 \Omega$	25°C	15 to -11	15 to -11.9		15 to -11	15 to -11.9	V		
		Full range	15 to -10.8			15 to -10.8				
V_{OM+} Maximum positive peak output voltage swing	$I_O = -200 \mu A$	25°C	13.8	14.1		13.8	14.1	V		
		Full range	13.7			13.7				
	$I_O = -2$ mA	25°C	13.5	13.9		13.5	13.9			
		Full range	13.4			13.4				
	$I_O = -20$ mA	25°C	11.5	12.3		11.5	12.3			
		Full range	11.5			11.5				
V_{OM-} Maximum negative peak output voltage swing	$I_O = 200 \mu A$	25°C	-13.8	-14.2		-13.8	-14.2	V		
		Full range	-13.7			-13.7				
	$I_O = 2$ mA	25°C	-13.5	-14		-13.5	-14			
		Full range	-13.4			-13.4				
	$I_O = 20$ mA	25°C	-11.5	-12.4		-11.5	-12.4			
		Full range	-11.5			-11.5				
A_{VD} Large-signal differential voltage amplification	$V_O = \pm 10$ V	$R_L = 600 \Omega$	25°C	80	96		80	96	dB	
			Full range	79			79			
		$R_L = 2$ k Ω	25°C	90	109		90	109		
			Full range	89			89			
		$R_L = 10$ k Ω	25°C	95	118		95	118		
			Full range	94			94			
r_i Input resistance	$V_{IC} = 0$	25°C	10^{12}			10^{12}			Ω	
c_i Input capacitance	$V_{IC} = 0,$ See Figure 5	Common mode	25°C	7.5			7.5			pF
		Differential	25°C	2.5			2.5			
z_o Open-loop output impedance	$f = 1$ MHz	25°C	80			80			Ω	
CMRR Common-mode rejection ratio	$V_{IC} = V_{ICRmin},$ $V_O = 0,$ $R_S = 50 \Omega$	25°C	80	98		80	98	dB		
		Full range	79			79				
k_{SVR} Supply-voltage rejection ratio ($\Delta V_{CC\pm}/\Delta V_{IO}$)	$V_{CC\pm} = \pm 5$ V to ± 15 V, $V_O = 0,$ $R_S = 50 \Omega$	25°C	82	99		82	99	dB		
		Full range	80			80				

† Full range is $-40^\circ C$ to $85^\circ C$.



TLE208x, TLE208xA, TLE208xY EXCALIBUR HIGH-SPEED JFET-INPUT OPERATIONAL AMPLIFIERS

SLOS182B – FEBRUARY 1997 – REVISED JUNE 2001

TLE2081I electrical characteristics at specified free-air temperature, $V_{CC\pm} = \pm 15\text{ V}$ (unless otherwise noted) (continued)

PARAMETER	TEST CONDITIONS	T_A †	TLE2081I			TLE2081AI			UNIT
			MIN	TYP	MAX	MIN	TYP	MAX	
I_{CC} Supply current	$V_O = 0$, No load	25°C	1.35	1.7	2.2	1.35	1.7	2.2	mA
		Full range	2.2			2.2			
I_{OS} Short-circuit output current	$V_O = 0$	25°C	$V_{ID} = 1\text{ V}$	-30	-45	-30	-45	mA	
			$V_{ID} = -1\text{ V}$	30	48	30	48		

† Full range is -40°C to 85°C .

TLE2081I operating characteristics at specified free-air temperature, $V_{CC\pm} = \pm 15\text{ V}$

PARAMETER	TEST CONDITIONS	T_A †	TLE2081I			TLE2081AI			UNIT
			MIN	TYP	MAX	MIN	TYP	MAX	
SR+ Positive slew rate	$V_{O(PP)} = \pm 10\text{ V}$, $A_{VD} = -1$, $C_L = 100\text{ pF}$, $R_L = 2\text{ k}\Omega$, See Figure 1	25°C	30	40	30	40	V/ μs		
		Full range	24			24			
SR- Negative slew rate		25°C	30	45	30	45	V/ μs		
		Full range	24			24			
t_s Settling time	$A_{VD} = -1$, 10-V step, $R_L = 1\text{ k}\Omega$, $C_L = 100\text{ pF}$	25°C	To 10 mV	0.4		0.4		μs	
			To 1 mV	1.5		1.5			
V_n Equivalent input noise voltage	$R_S = 20\ \Omega$, See Figure 3	25°C	$f = 10\text{ Hz}$	28		28		nV/ $\sqrt{\text{Hz}}$	
			$f = 10\text{ kHz}$	11.6		11.6			
$V_{N(PP)}$ Peak-to-peak equivalent input noise voltage		$f = 10\text{ Hz to }10\text{ kHz}$	25°C	6		6		μV	
				$f = 0.1\text{ Hz to }10\text{ Hz}$	0.6		0.6		
I_n Equivalent input noise current	$V_{IC} = 0$, $f = 10\text{ kHz}$	25°C	2.8		2.8		fA/ $\sqrt{\text{Hz}}$		
THD + N Total harmonic distortion plus noise	$V_{O(PP)} = 20\text{ V}$, $A_{VD} = 10$, $f = 1\text{ kHz}$, $R_L = 2\text{ k}\Omega$, $R_S = 25\ \Omega$	25°C	0.008%		0.008%				
B_1 Unity-gain bandwidth	$V_I = 10\text{ mV}$, $R_L = 2\text{ k}\Omega$, $C_L = 25\text{ pF}$, See Figure 2	25°C	8	10	8	10	MHz		
BOM Maximum output-swing bandwidth	$V_{O(PP)} = 20\text{ V}$, $A_{VD} = -1$, $R_L = 2\text{ k}\Omega$, $C_L = 25\text{ pF}$	25°C	478	637	478	637	kHz		
ϕ_m Phase margin at unity gain	$V_I = 10\text{ mV}$, $R_L = 2\text{ k}\Omega$, $C_L = 25\text{ pF}$, See Figure 2	25°C	57°		57°				

† Full range is -40°C to 85°C .



TLE208x, TLE208xA, TLE208xY
EXCALIBUR HIGH-SPEED JFET-INPUT
OPERATIONAL AMPLIFIERS

SLOS182B – FEBRUARY 1997 – REVISED JUNE 2001

TLE2081M electrical characteristics at specified free-air temperature, $V_{CC\pm} = \pm 5$ V (unless otherwise noted)

PARAMETER	TEST CONDITIONS	T_A †	TLE2081M			TLE2081AM			UNIT	
			MIN	TYP	MAX	MIN	TYP	MAX		
V_{IO} Input offset voltage	$V_{IC} = 0,$ $V_O = 0,$ $R_S = 50\Omega$	25°C	0.34	6		0.3	3	mV		
		Full range			11.2		8.2			
αV_{IO} Temperature coefficient of input offset voltage		Full range	3.2	29*		3.2	29*	$\mu V/^\circ C$		
I_{IO} Input offset current	$V_{IC} = 0,$ $V_O = 0,$ See Figure 4	25°C	5	100		5	100	pA		
		Full range			20		20	nA		
I_{IB} Input bias current		25°C	15	175		15	175	pA		
		Full range			65		65	nA		
V_{ICR} Common-mode input voltage range	$R_S = 50\Omega$	25°C	5 to -1	5 to -1.9		5 to -1	5 to -1.9	V		
		Full range	5 to -0.8			5 to -0.8				
V_{OM+} Maximum positive peak output voltage swing	$I_O = -200\mu A$	25°C	3.8	4.1		3.8	4.1	V		
		Full range	3.6			3.6				
	$I_O = -2$ mA	25°C	3.5	3.9		3.5	3.9			
		Full range	3.3			3.3				
	$I_O = -20$ mA	25°C	1.5	2.3		1.5	2.3			
		Full range	1.4			1.4				
V_{OM-} Maximum negative peak output voltage swing	$I_O = 200\mu A$	25°C	-3.8	-4.2		-3.8	-4.2	V		
		Full range	-3.6			-3.6				
	$I_O = 2$ mA	25°C	-3.5	-4.1		-3.5	-4.1			
		Full range	-3.3			-3.3				
	$I_O = 20$ mA	25°C	-1.5	-2.4		-1.5	-2.4			
		Full range	-1.4			-1.4				
A_{VD} Large-signal differential voltage amplification	$V_O = \pm 2.3$ V	$R_L = 600\Omega$	25°C	80	91		80	91	dB	
			Full range	78			78			
		$R_L = 2$ k Ω	25°C	90	100		90	100		
			Full range	88			88			
		$R_L = 10$ k Ω	25°C	95	106		95	106		
			Full range	93			93			
r_i Input resistance	$V_{IC} = 0$	25°C	10^{12}			10^{12}			Ω	
c_i Input capacitance	$V_{IC} = 0,$ See Figure 5	Common mode	25°C	11			11			pF
		Differential	25°C	2.5			2.5			
z_o Open-loop output impedance	$f = 1$ MHz	25°C	80			80			Ω	
CMRR Common-mode rejection ratio	$V_{IC} = V_{ICRmin},$ $V_O = 0,$ $R_S = 50\Omega$	25°C	70	89		70	89	dB		
		Full range	68			68				
k_{SVR} Supply-voltage rejection ratio ($\Delta V_{CC\pm}/\Delta V_{IO}$)	$V_{CC\pm} = \pm 5$ V to ± 15 V, $V_O = 0,$ $R_S = 50\Omega$	25°C	82	99		82	99	dB		
		Full range	80			80				

*On products compliant with MIL-PRF-38535, Class B, this parameter is not production tested.

† Full range is $-55^\circ C$ to $125^\circ C$.



TLE208x, TLE208xA, TLE208xY
EXCALIBUR HIGH-SPEED JFET-INPUT
OPERATIONAL AMPLIFIERS

SLOS182B – FEBRUARY 1997 – REVISED JUNE 2001

TLE2081M electrical characteristics at specified free-air temperature, $V_{CC\pm} = \pm 5\text{ V}$ (unless otherwise noted) (continued)

PARAMETER	TEST CONDITIONS	T_A †	TLE2081M			TLE2081AM			UNIT	
			MIN	TYP	MAX	MIN	TYP	MAX		
I_{CC}	Supply current	$V_O = 0$, No load	25°C	1.35	1.6	2.2	1.35	1.6	2.2	mA
			Full range	2.2			2.2			
I_{OS}	Short-circuit output current	$V_O = 0$	$V_{ID} = 1\text{ V}$	-35			-35			mA
			$V_{ID} = -1\text{ V}$	45			45			

† Full range is -55°C to 125°C .

TLE2081M operating characteristics at specified free-air temperature, $V_{CC\pm} = \pm 5\text{ V}$

PARAMETER	TEST CONDITIONS	T_A †	TLE2081M			TLE2081AM			UNIT	
			MIN	TYP	MAX	MIN	TYP	MAX		
$SR+$	Positive slew rate	$V_{O(PP)} = \pm 2.3\text{ V}$, $A_{VD} = -1$, $R_L = 2\text{ k}\Omega$, $C_L = 100\text{ pF}$, See Figure 1	25°C	35			35			$\text{V}/\mu\text{s}$
			Full range	20*			20*			
$SR-$	Negative slew rate	$V_{O(PP)} = \pm 2.3\text{ V}$, $A_{VD} = -1$, $R_L = 2\text{ k}\Omega$, $C_L = 100\text{ pF}$, See Figure 1	25°C	38			38			$\text{V}/\mu\text{s}$
			Full range	20*			20*			
t_s	Settling time	$A_{VD} = -1$, 2-V step, $R_L = 1\text{ k}\Omega$, $C_L = 100\text{ pF}$	To 10 mV	0.25			0.25			μs
			To 1 mV	0.4			0.4			
V_n	Equivalent input noise voltage	$R_S = 20\ \Omega$, See Figure 3	f = 10 Hz	28			28			$\text{nV}/\sqrt{\text{Hz}}$
			f = 10 kHz	11.6			11.6			
$V_{N(PP)}$	Peak-to-peak equivalent input noise voltage	$R_S = 20\ \Omega$, See Figure 3	f = 10 Hz to 10 kHz	6			6			μV
			f = 0.1 Hz to 10 Hz	0.6			0.6			
I_n	Equivalent input noise current	$V_{IC} = 0$, f = 10 kHz	25°C	2.8			2.8			$\text{fA}/\sqrt{\text{Hz}}$
THD + N	Total harmonic distortion plus noise	$V_{O(PP)} = 5\text{ V}$, f = 1 kHz, $R_S = 25\ \Omega$	25°C	0.013%			0.013%			
B_1	Unity-gain bandwidth	$V_I = 10\text{ mV}$, $C_L = 25\text{ pF}$, $R_L = 2\text{ k}\Omega$, See Figure 2	25°C	9.4			9.4			MHz
B_{OM}	Maximum output-swing bandwidth	$V_{O(PP)} = 4\text{ V}$, $R_L = 2\text{ k}\Omega$, $C_L = 25\text{ pF}$	25°C	2.8			2.8			MHz
ϕ_m	Phase margin at unity gain	$V_I = 10\text{ mV}$, $C_L = 25\text{ pF}$, $R_L = 2\text{ k}\Omega$, See Figure 2	25°C	56°			56°			

*On products compliant with MIL-PRF-38535, Class B, this parameter is not production tested.

† Full range is -55°C to 125°C .



TLE208x, TLE208xA, TLE208xY
EXCALIBUR HIGH-SPEED JFET-INPUT
OPERATIONAL AMPLIFIERS

SLOS182B – FEBRUARY 1997 – REVISED JUNE 2001

TLE2081M electrical characteristics at specified free-air temperature, $V_{CC\pm} = \pm 15$ V (unless otherwise noted)

PARAMETER	TEST CONDITIONS	T_A †	TLE2081M			TLE2081AM			UNIT
			MIN	TYP	MAX	MIN	TYP	MAX	
V_{IO} Input offset voltage	$V_{IC} = 0,$ $R_S = 50 \Omega$	$V_O = 0,$	25°C	0.49	6	0.47	3	mV	
			Full range	11.2			8.2		
α_{VIO} Temperature coefficient of input offset voltage			Full range	3.2	29*	3.2	29*	$\mu V/^\circ C$	
I_{IO} Input offset current	$V_{IC} = 0,$ See Figure 4	$V_O = 0,$	25°C	6	100	6	100	pA	
			Full range	20			20		
I_{IB} Input bias current			25°C	20	175	20	175	pA	
			Full range	65			65		
V_{ICR} Common-mode input voltage range	$R_S = 50 \Omega$		25°C	15 to -11	15 to -11.9	15 to -11	15 to -11.9	V	
			Full range	15 to -10.8		15 to -10.8			
V_{OM+} Maximum positive peak output voltage swing	$I_O = -200 \mu A$		25°C	13.8	14.1	13.8	14.1	V	
			Full range	13.6			13.6		
	$I_O = -2$ mA		25°C	13.5	13.9	13.5	13.9		
			Full range	13.3			13.3		
	$I_O = -20$ mA		25°C	11.5	12.3	11.5	12.3		
			Full range	11.4			11.4		
V_{OM-} Maximum negative peak output voltage swing	$I_O = 200 \mu A$		25°C	-13.8	-14.2	-13.8	-14.2	V	
			Full range	-13.6			-13.6		
	$I_O = 2$ mA		25°C	-13.5	-14	-13.5	-14		
			Full range	-13.3			-13.3		
	$I_O = 20$ mA		25°C	-11.5	-12.4	-11.5	-12.4		
			Full range	-11.4			-11.4		
A_{VD} Large-signal differential voltage amplification	$V_O = \pm 10$ V	$R_L = 600 \Omega$	25°C	80	96	80	96	dB	
			Full range	78			78		
		$R_L = 2$ k Ω	25°C	90	109	90	109		
			Full range	88			88		
		$R_L = 10$ k Ω	25°C	95	118	95	118		
			Full range	93			93		
r_i Input resistance	$V_{IC} = 0$		25°C	10^{12}			10^{12}	Ω	
c_i Input capacitance	$V_{IC} = 0,$ See Figure 5	Common mode	25°C	7.5			7.5	pF	
		Differential	25°C	2.5			2.5		
z_o Open-loop output impedance	$f = 1$ MHz		25°C	80			80	Ω	
CMRR Common-mode rejection ratio	$V_{IC} = V_{ICRmin},$ $V_O = 0,$ $R_S = 50 \Omega$		25°C	80	98	80	98	dB	
			Full range	78			78		
k_{SVR} Supply-voltage rejection ratio ($\Delta V_{CC\pm} / \Delta V_{IO}$)	$V_{CC\pm} = \pm 5$ V to ± 15 V, $V_O = 0,$ $R_S = 50 \Omega$		25°C	82	99	82	99	dB	
			Full range	80			80		

*On products compliant with MIL-PRF-38535, Class B, this parameter is not production tested.

† Full range is $-55^\circ C$ to $125^\circ C$.



TLE208x, TLE208xA, TLE208xY EXCALIBUR HIGH-SPEED JFET-INPUT OPERATIONAL AMPLIFIERS

SLOS182B – FEBRUARY 1997 – REVISED JUNE 2001

TLE2081M electrical characteristics at specified free-air temperature, $V_{CC\pm} = \pm 15\text{ V}$ (unless otherwise noted)(continued)

PARAMETER	TEST CONDITIONS	T_A †	TLE2081M			TLE2081AM			UNIT	
			MIN	TYP	MAX	MIN	TYP	MAX		
I_{CC}	Supply current	$V_O = 0$, No load	25°C	1.35	1.7	2.2	1.35	1.7	2.2	mA
			Full range	2.2			2.2			
I_{OS}	Short-circuit output current	$V_O = 0$	25°C	$V_{ID} = 1\text{ V}$	-30	-45	-30	-45	mA	
				$V_{ID} = -1\text{ V}$	30	48	30	48		

† Full range is -55°C to 125°C .

TLE2081M operating characteristics at specified free-air temperature, $V_{CC\pm} = \pm 15\text{ V}$

PARAMETER	TEST CONDITIONS	T_A †	TLE2081M			TLE2081AM			UNIT	
			MIN	TYP	MAX	MIN	TYP	MAX		
SR+	Positive slew rate	$V_{O(PP)} = 10\text{ V}$, $A_{VD} = -1$, $C_L = 100\text{ pF}$, $R_L = 2\text{ k}\Omega$, See Figure 1	25°C	30	40	30	40	$\text{V}/\mu\text{s}$		
			Full range	22			22			
SR-	Negative slew rate	$V_{O(PP)} = 10\text{ V}$, $A_{VD} = -1$, $C_L = 100\text{ pF}$, $R_L = 2\text{ k}\Omega$, See Figure 1	25°C	30	45	30	45	$\text{V}/\mu\text{s}$		
			Full range	22			22			
t_s	Settling time	$A_{VD} = -1$, 10-V step, $R_L = 1\text{ k}\Omega$, $C_L = 100\text{ pF}$	To 10 mV	0.4			0.4			μs
			To 1 mV	1.5			1.5			
V_n	Equivalent input noise voltage	$R_S = 20\ \Omega$, See Figure 3	f = 10 Hz	28			28			$\text{nV}/\sqrt{\text{Hz}}$
			f = 10 kHz	11.6			11.6			
$V_{N(PP)}$	Peak-to-peak equivalent input noise voltage	$R_S = 20\ \Omega$, See Figure 3	f = 10 Hz to 10 kHz	6			6			μV
			f = 0.1 Hz to 10 Hz	0.6			0.6			
I_n	Equivalent input noise current	$V_{IC} = 0$, f = 10 kHz	25°C	2.8			2.8			$\text{fA}/\sqrt{\text{Hz}}$
THD + N	Total harmonic distortion plus noise	$V_{O(PP)} = 20\text{ V}$, f = 1 kHz, $R_S = 25\ \Omega$	25°C	0.008%			0.008%			
B_1	Unity-gain bandwidth	$V_I = 10\text{ mV}$, $C_L = 25\text{ pF}$, $R_L = 2\text{ k}\Omega$, See Figure 2	25°C	8*	10	8*	10	MHz		
BOM	Maximum output-swing bandwidth	$V_{O(PP)} = 20\text{ V}$, $R_L = 2\text{ k}\Omega$, $C_L = 25\text{ pF}$	25°C	478*	637	478*	637	kHz		
ϕ_m	Phase margin at unity gain	$V_I = 10\text{ mV}$, $C_L = 25\text{ pF}$, $R_L = 2\text{ k}\Omega$, See Figure 2	25°C	57°			57°			

*On products compliant with MIL-PRF-38535, Class B, this parameter is not production tested.

† Full range is -55°C to 125°C .



TLE208x, TLE208xA, TLE208xY
EXCALIBUR HIGH-SPEED JFET-INPUT
OPERATIONAL AMPLIFIERS

SLOS182B – FEBRUARY 1997 – REVISED JUNE 2001

TLE2081Y electrical characteristics at $V_{CC\pm} = \pm 15\text{ V}$, $T_A = 25^\circ\text{C}$

PARAMETER		TEST CONDITIONS		TLE2081Y			UNIT
				MIN	TYP	MAX	
V_{IO}	Input offset voltage	$V_{IC} = 0$,	$V_O = 0$, $R_S = 50\ \Omega$	0.49	6		mV
I_{IO}	Input offset current	$V_{IC} = 0$,	$V_O = 0$, See Figure 4	6	100		pA
I_{IB}	Input bias current			20	175		
V_{ICR}	Common-mode input voltage range	$R_S = 50\ \Omega$		15 to -11	15 to 11.9		V
V_{OM+}	Maximum positive peak output voltage swing	$I_O = -200\ \mu\text{A}$		13.8	14.1		V
		$I_O = -2\ \text{mA}$		13.5	13.9		
		$I_O = -20\ \text{mA}$		11.5	12.3		
V_{OM-}	Maximum negative peak output voltage swing	$I_O = 200\ \mu\text{A}$		-13.8	-14.2		V
		$I_O = 2\ \text{mA}$		-13.5	-14		
		$I_O = 20\ \text{mA}$		-11.5	-12.4		
A_{VD}	Large-signal differential voltage amplification	$V_O = \pm 10\ \text{V}$	$R_L = 600\ \Omega$	80	96		dB
			$R_L = 2\ \text{k}\Omega$	90	109		
			$R_L = 10\ \text{k}\Omega$	95	118		
r_i	Input resistance	$V_{IC} = 0$		10 ¹²			Ω
c_i	Input capacitance	$V_{IC} = 0$, See Figure 5	Common mode	7.5			pF
			Differential	2.5			
z_o	Open-loop output impedance	$f = 1\ \text{MHz}$		80			Ω
CMRR	Common-mode rejection ratio	$V_{IC} = V_{ICR\text{min}}$,	$V_O = 0$, $R_S = 50\ \Omega$	80	98		dB
k_{SVR}	Supply-voltage rejection ratio ($\Delta V_{CC\pm} / \Delta V_{IO}$)	$V_{CC\pm} = \pm 5\ \text{V}$ to $\pm 15\ \text{V}$, $V_O = 0$, $R_S = 50\ \Omega$		82	99		dB
I_{CC}	Supply current	$V_O = 0$,	No load	1.35	1.7	2.2	mA
I_{OS}	Short-circuit output current	$V_O = 0$	$V_{ID} = 1\ \text{V}$	-30	-45		mA
			$V_{ID} = -1\ \text{V}$	30	48		

TLE208x, TLE208xA, TLE208xY EXCALIBUR HIGH-SPEED JFET-INPUT OPERATIONAL AMPLIFIERS

SLOS182B – FEBRUARY 1997 – REVISED JUNE 2001

TLE2082C electrical characteristics at specified free-air temperature, $V_{CC\pm} = \pm 5$ V (unless otherwise noted)

PARAMETER	TEST CONDITIONS	T_A †	TLE2082C			TLE2082AC			UNIT	
			MIN	TYP	MAX	MIN	TYP	MAX		
V_{IO} Input offset voltage	$V_{IC} = 0, V_O = 0, R_S = 50 \Omega$	25°C	0.9	6		0.65	4	mV		
		Full range			8.1		5.1			
α_{VIO} Temperature coefficient of input offset voltage		Full range	2.3	25		2.3	25	$\mu V/^\circ C$		
I_{IO} Input offset current	$V_{IC} = 0, V_O = 0, \text{See Figure 4}$	25°C	5	100		5	100	pA		
		Full range			1.4		1.4	nA		
I_{IB} Input bias current		25°C	15	175		15	175	pA		
		Full range			5		5	nA		
V_{ICR} Common-mode input voltage range	$R_S = 50 \Omega$	25°C	5 to -1	5 to -1.9		5 to -1	5 to -1.9	V		
		Full range	5 to -0.9			5 to -0.9				
V_{OM+} Maximum positive peak output voltage swing	$I_O = -200 \mu A$	25°C	3.8	4.1		3.8	4.1	V		
		Full range			3.7		3.7			
	$I_O = -2 \text{ mA}$	25°C	3.5	3.9		3.5	3.9			
		Full range			3.4		3.4			
$I_O = -20 \text{ mA}$	25°C	1.5	2.3		1.5	2.3				
	Full range			1.5		1.5				
V_{OM-} Maximum negative peak output voltage swing	$I_O = 200 \mu A$	25°C	-3.8	-4.2		-3.8	-4.2	V		
		Full range			-3.7		-3.7			
	$I_O = 2 \text{ mA}$	25°C	-3.5	-4.1		-3.5	-4.1			
		Full range			-3.4		-3.4			
$I_O = 20 \text{ mA}$	25°C	-1.5	-2.4		-1.5	-2.4				
	Full range			-1.5		-1.5				
A_{VD} Large-signal differential voltage amplification	$V_O = \pm 2.3 \text{ V}$	$R_L = 600 \Omega$	25°C	80	91		80	91	dB	
			Full range			79		79		
		$R_L = 2 \text{ k}\Omega$	25°C	90	100		90	100		
			Full range			89		89		
		$R_L = 10 \text{ k}\Omega$	25°C	95	106		95	106		
			Full range			94		94		
r_i Input resistance	$V_{IC} = 0$	25°C	10^{12}			10^{12}			Ω	
c_i Input capacitance	Common mode	$V_{IC} = 0, \text{See Figure 5}$	25°C	11			11			pF
	Differential		25°C	2.5			2.5			
z_o Open-loop output impedance	$f = 1 \text{ MHz}$	25°C	80			80			Ω	
CMRR Common-mode rejection ratio	$V_{IC} = V_{ICRmin}, V_O = 0, R_S = 50 \Omega$	25°C	70	89		70	89	dB		
		Full range			68		68			
k_{SVR} Supply-voltage rejection ratio ($\Delta V_{CC\pm} / \Delta V_{IO}$)	$V_{CC\pm} = \pm 5 \text{ V to } \pm 15 \text{ V}, V_O = 0, R_S = 50 \Omega$	25°C	82	99		82	99	dB		
		Full range			80		80			
I_{CC} Supply current (both channels)	$V_O = 0, \text{No load}$	25°C	2.7	2.9	3.9	2.7	2.9	3.9	mA	
		Full range			3.9		3.9			

† Full range is 0°C to 70°C.



TLE208x, TLE208xA, TLE208xY
EXCALIBUR HIGH-SPEED JFET-INPUT
OPERATIONAL AMPLIFIERS

SLOS182B – FEBRUARY 1997 – REVISED JUNE 2001

TLE2082C electrical characteristics at specified free-air temperature, $V_{CC\pm} = \pm 5$ V (unless otherwise noted) (continued)

PARAMETER	TEST CONDITIONS	T_A	TLE2082C			TLE2082AC			UNIT
			MIN	TYP	MAX	MIN	TYP	MAX	
Crosstalk attenuation	$V_{IC} = 0$, $R_L = 2$ k Ω	25°C	120			120			dB
I_{OS} Short-circuit output current	$V_O = 0$	25°C	$V_{ID} = 1$ V			-35			mA
			$V_{ID} = -1$ V			45			

TLE2082C operating characteristics at specified free-air temperature, $V_{CC\pm} = \pm 5$ V

PARAMETER	TEST CONDITIONS	T_A †	TLE2082C			TLE2082AC			UNIT	
			MIN	TYP	MAX	MIN	TYP	MAX		
SR+ Positive slew rate	$V_{O(PP)} = \pm 2.3$ V, $A_{VD} = -1$, $C_L = 100$ pF, $R_L = 2$ k Ω , See Figure 1	25°C	35			35			V/ μ s	
		Full range	22			22				
SR- Negative slew rate		25°C	38			38			V/ μ s	
		Full range	22			22				
t_s Settling time	$A_{VD} = -1$, 2-V step, $R_L = 1$ k Ω , $C_L = 100$ pF	To 10 mV	0.25			0.25			μ s	
		To 1 mV	0.4			0.4				
V_n Equivalent input noise voltage	$R_S = 20$ Ω , See Figure 3	f = 10 Hz	28			28			nV/ \sqrt{Hz}	
		f = 10 kHz	11.6			11.6				
$V_{N(PP)}$ Peak-to-peak equivalent input noise voltage		f = 10 Hz to 10 kHz	6			6			μ V	
		f = 0.1 Hz to 10 Hz	0.6			0.6				
I_n Equivalent input noise current	$V_{IC} = 0$, f = 10 kHz	25°C	2.8			2.8			fA/ \sqrt{Hz}	
THD + N Total harmonic distortion plus noise	$V_{O(PP)} = 5$ V, f = 1 kHz, $R_S = 25$ Ω	$A_{VD} = 10$, $R_L = 2$ k Ω ,	25°C	0.013%			0.013%			
B_1 Unity-gain bandwidth	$V_I = 10$ mV, $C_L = 25$ pF,	$R_L = 2$ k Ω , See Figure 2	25°C	9.4			9.4			MHz
B_{OM} Maximum output-swing bandwidth	$V_{O(PP)} = 4$ V, $R_L = 2$ k Ω ,	$A_{VD} = -1$, $C_L = 25$ pF	25°C	2.8			2.8			MHz
ϕ_m Phase margin at unity gain	$V_I = 10$ mV, $C_L = 25$ pF,	$R_L = 2$ k Ω , See Figure 2	25°C	56°			56°			

† Full range is 0°C to 70°C.

TLE208x, TLE208xA, TLE208xY EXCALIBUR HIGH-SPEED JFET-INPUT OPERATIONAL AMPLIFIERS

SLOS182B – FEBRUARY 1997 – REVISED JUNE 2001

TLE2082C electrical characteristics at specified free-air temperature, $V_{CC\pm} = \pm 15\text{ V}$ (unless otherwise noted)

PARAMETER	TEST CONDITIONS	T_A †	TLE2082C			TLE2082AC			UNIT	
			MIN	TYP	MAX	MIN	TYP	MAX		
V_{IO} Input offset voltage	$V_{IC} = 0,$ $R_S = 50\ \Omega$ $V_O = 0,$	25°C	1.1	7		0.7	4	mV		
		Full range			8.1		5.1			
α_{VIO} Temperature coefficient of input offset voltage		Full range	2.4	25		2.4	25	$\mu\text{V}/^\circ\text{C}$		
I_{IO} Input offset current	$V_{IC} = 0,$ $V_O = 0,$ See Figure 4	25°C	6	100		6	100	pA		
		Full range			1.4		1.4	nA		
I_{IB} Input bias current		25°C	20	175		20	175	pA		
		Full range			5		5	nA		
V_{ICR} Common-mode input voltage range	$R_S = 50\ \Omega$	25°C	15 to -11	15 to -11.9		15 to -11	15 to -11.9	V		
		Full range	15 to -10.9			15 to -10.9				
V_{OM+} Maximum positive peak output voltage swing	$I_O = -200\ \mu\text{A}$	25°C	13.8	14.1		13.8	14.1	V		
		Full range	13.6			13.6				
	$I_O = -2\ \text{mA}$	25°C	13.5	13.9		13.5	13.9			
		Full range	13.4			13.4				
	$I_O = -20\ \text{mA}$	25°C	11.5	12.3		11.5	12.3			
		Full range	11.5			11.5				
V_{OM-} Maximum negative peak output voltage swing	$I_O = 200\ \mu\text{A}$	25°C	-13.8	-14.2		-13.8	-14.2	V		
		Full range	-13.7			-13.7				
	$I_O = 2\ \text{mA}$	25°C	-13.5	-14		-13.5	-14			
		Full range	-13.4			-13.4				
	$I_O = 20\ \text{mA}$	25°C	-11.5	-12.4		-11.5	-12.4			
		Full range	-11.5			-11.5				
A_{VD} Large-signal differential voltage amplification	$V_O = \pm 10\ \text{V}$	$R_L = 600\ \Omega$	25°C	80	96		80	96	dB	
			Full range	79			79			
		$R_L = 2\ \text{k}\Omega$	25°C	90	109		90	109		
			Full range	89			89			
		$R_L = 10\ \text{k}\Omega$	25°C	95	118		95	118		
			Full range	94			94			
r_i Input resistance	$V_{IC} = 0$	25°C	10^{12}			10^{12}			Ω	
c_i Input capacitance	Common mode	$V_{IC} = 0,$ See Figure 5	25°C	7.5			7.5			pF
	Differential		25°C	2.5			2.5			
z_o Open-loop output impedance	$f = 1\ \text{MHz}$	25°C	80			80			Ω	
CMRR Common-mode rejection ratio	$V_{IC} = V_{ICRmin},$ $V_O = 0,$ $R_S = 50\ \Omega$	25°C	80	98		80	98	dB		
		Full range	79			79				
k_{SVR} Supply-voltage rejection ratio ($\Delta V_{CC\pm}/\Delta V_{IO}$)	$V_{CC\pm} = \pm 5\ \text{V}$ to $\pm 15\ \text{V},$ $V_O = 0,$ $R_S = 50\ \Omega$	25°C	82	99		82	99	dB		
		Full range	81			81				

† Full range is 0°C to 70°C.



TLE208x, TLE208xA, TLE208xY
EXCALIBUR HIGH-SPEED JFET-INPUT
OPERATIONAL AMPLIFIERS

SLOS182B – FEBRUARY 1997 – REVISED JUNE 2001

TLE2082C electrical characteristics at specified free-air temperature, $V_{CC\pm} = \pm 15$ V (unless otherwise noted) (continued)

PARAMETER	TEST CONDITIONS	T_A	TLE2082C			TLE2082AC			UNIT
			MIN	TYP	MAX	MIN	TYP	MAX	
I_{CC} Supply current (both channels)	$V_O = 0$, No load	25°C	2.7	3.1	3.9	2.7	3.1	3.9	mA
		Full range	3.9			3.9			
Crosstalk attenuation	$V_{IC} = 0$, $R_L = 2$ k Ω	25°C	120			120			dB
I_{OS} Short-circuit output current	$V_O = 0$	$V_{ID} = 1$ V	25°C	-30	-45	-30	-45	mA	
		$V_{ID} = -1$ V	30	48	30	48			

TLE2082C operating characteristics at specified free-air temperature, $V_{CC\pm} = \pm 15$ V

PARAMETER	TEST CONDITIONS	T_A †	TLE2082C			TLE2082AC			UNIT
			MIN	TYP	MAX	MIN	TYP	MAX	
SR+ Positive slew rate	$V_{O(PP)} = 10$ V, $A_{VD} = -1$, $R_L = 2$ k Ω , $C_L = 100$ pF, See Figure 1	25°C	28	40		28	40	V/ μ s	
		Full range	25			25			
SR- Negative slew rate		25°C	30	45		30	45	V/ μ s	
		Full range	25			25			
t_s Settling time	$A_{VD} = -1$, 10-V step, $R_L = 1$ k Ω , $C_L = 100$ pF	To 10 mV	25°C			0.4			μ s
		To 1 mV	1.5			1.5			
V_n Equivalent input noise voltage	$R_S = 20$ Ω , See Figure 3	f = 10 Hz	25°C			28			nV/ \sqrt{Hz}
		f = 10 kHz	11.6			11.6			
$V_{N(PP)}$ Peak-to-peak equivalent input noise voltage		f = 10 Hz to 10 kHz	25°C			6			μ V
		f = 0.1 Hz to 10 Hz	0.6			0.6			
I_n Equivalent input noise current	$V_{IC} = 0$, f = 10 kHz	25°C	2.8			2.8			fA/ \sqrt{Hz}
THD + N Total harmonic distortion plus noise	$V_{O(PP)} = 20$ V, $A_{VD} = 10$, f = 1 kHz, $R_S = 25$ Ω	25°C	0.008%			0.008%			
B_1 Unity-gain bandwidth	$V_I = 10$ mV, $R_L = 2$ k Ω , $C_L = 25$ pF, See Figure 2	25°C	8	10		8	10	MHz	
B_{OM} Maximum output-swing bandwidth	$V_{O(PP)} = 20$ V, $A_{VD} = -1$, $R_L = 2$ k Ω , $C_L = 25$ pF	25°C	478	637		478	637	kHz	
ϕ_m Phase margin at unity gain	$V_I = 10$ mV, $R_L = 2$ k Ω , $C_L = 25$ pF, See Figure 2	25°C	57°			57°			

† Full range is 0°C to 70°C.

TLE208x, TLE208xA, TLE208xY EXCALIBUR HIGH-SPEED JFET-INPUT OPERATIONAL AMPLIFIERS

SLOS182B – FEBRUARY 1997 – REVISED JUNE 2001

TLE2082I electrical characteristics at specified free-air temperature, $V_{CC\pm} = \pm 5\text{ V}$ (unless otherwise noted)

PARAMETER	TEST CONDITIONS	T_A †	TLE2082I			TLE2082AI			UNIT	
			MIN	TYP	MAX	MIN	TYP	MAX		
V_{IO} Input offset voltage	$V_{IC} = 0, V_O = 0, R_S = 50\ \Omega$	25°C	0.9	7		0.65	4	mV		
		Full range			8.5		5.5			
α_{VIO} Temperature coefficient of input offset voltage		Full range	2.4	25		2.4	25	$\mu\text{V}/^\circ\text{C}$		
I_{IO} Input offset current	$V_{IC} = 0, V_O = 0, \text{See Figure 4}$	25°C	5	100		5	100	pA		
		Full range			5		5	nA		
I_{IB} Input bias current		25°C	15	175		15	175	pA		
		Full range			10		10	nA		
V_{ICR} Common-mode input voltage range	$R_S = 50\ \Omega$	25°C	5 to -1	5 to -1.9		5 to -1	5 to -1.9	V		
		Full range	5 to -0.8			5 to -0.8				
V_{OM+} Maximum positive peak output voltage swing	$I_O = -200\ \mu\text{A}$	25°C	3.8	4.1		3.8	4.1	V		
		Full range	3.7			3.7				
	$I_O = -2\ \text{mA}$	25°C	3.5	3.9		3.5	3.9			
		Full range	3.4			3.4				
	$I_O = -20\ \text{mA}$	25°C	1.5	2.3		1.5	2.3			
		Full range	1.5			1.5				
V_{OM-} Maximum negative peak output voltage swing	$I_O = 200\ \mu\text{A}$	25°C	-3.8	-4.2		-3.8	-4.2	V		
		Full range	-3.7			-3.7				
	$I_O = 2\ \text{mA}$	25°C	-3.5	-4.1		-3.5	-4.1			
		Full range	-3.4			-3.4				
	$I_O = 20\ \text{mA}$	25°C	-1.5	-2.4		-1.5	-2.4			
		Full range	-1.5			-1.5				
A_{VD} Large-signal differential voltage amplification	$V_O = \pm 2.3\ \text{V}$	$R_L = 600\ \Omega$	25°C	80	91		80	91	dB	
			Full range	79			79			
		$R_L = 2\ \text{k}\Omega$	25°C	90	100		90	100		
			Full range	89			89			
		$R_L = 10\ \text{k}\Omega$	25°C	95	106		95	106		
			Full range	94			94			
r_i Input resistance	$V_{IC} = 0$	25°C	10^{12}			10^{12}			Ω	
c_i Input capacitance	Common mode	$V_{IC} = 0,$	25°C	11			11			pF
	Differential	See Figure 5	25°C	2.5			2.5			
z_o Open-loop output impedance	$f = 1\ \text{MHz}$	25°C	80			80			Ω	
CMRR Common-mode rejection ratio	$V_{IC} = V_{ICRmin}, V_O = 0, R_S = 50\ \Omega$	25°C	70	89		70	89	dB		
		Full range	68			68				
k_{SVR} Supply-voltage rejection ratio ($\Delta V_{CC\pm}/\Delta V_{IO}$)	$V_{CC\pm} = \pm 5\ \text{V to } \pm 15\ \text{V}, V_O = 0, R_S = 50\ \Omega$	25°C	82	99		82	99	dB		
		Full range	80			80				
I_{CC} Supply current (both channels)	$V_O = 0, \text{No load}$	25°C	2.7	2.9	3.9	2.7	2.9	3.9	mA	
		Full range			3.9			3.9		

† Full range is -40°C to 85°C .



TLE208x, TLE208xA, TLE208xY
EXCALIBUR HIGH-SPEED JFET-INPUT
OPERATIONAL AMPLIFIERS

SLOS182B – FEBRUARY 1997 – REVISED JUNE 2001

TLE2082I electrical characteristics at specified free-air temperature, $V_{CC\pm} = \pm 5\text{ V}$ (unless otherwise noted) (continued)

PARAMETER	TEST CONDITIONS	T_A	TLE2082I			TLE2082AI			UNIT
			MIN	TYP	MAX	MIN	TYP	MAX	
Crosstalk attenuation	$V_{IC} = 0$, $R_L = 2\text{ k}\Omega$	25°C	120			120			dB
I_{OS} Short-circuit output current	$V_O = 0$	25°C	$V_{ID} = 1\text{ V}$			-35			mA
			$V_{ID} = -1\text{ V}$			45			

TLE2082I operating characteristics at specified free-air temperature, $V_{CC\pm} = \pm 5\text{ V}$

PARAMETER	TEST CONDITIONS	T_A †	TLE2082I			TLE2082AI			UNIT	
			MIN	TYP	MAX	MIN	TYP	MAX		
SR+ Positive slew rate	$V_{O(PP)} = \pm 2.3\text{ V}$, $A_{VD} = -1$, $R_L = 2\text{ k}\Omega$, $C_L = 100\text{ pF}$, See Figure 1	25°C	35			35			V/ μs	
		Full range	20			20				
SR- Negative slew rate		25°C	38			38			V/ μs	
		Full range	20			20				
t_s Settling time	$A_{VD} = -1$, 2-V step, $R_L = 1\text{ k}\Omega$, $C_L = 100\text{ pF}$	25°C	To 10 mV			0.25			μs	
			To 1 mV			0.4				
V_n Equivalent input noise voltage		25°C	f = 10 Hz			28			nV/ $\sqrt{\text{Hz}}$	
			f = 10 kHz			11.6				
$V_{N(PP)}$ Peak-to-peak equivalent input noise voltage	$R_S = 20\ \Omega$, See Figure 3	25°C	f = 10 Hz to 10 kHz			6			μV	
			f = 0.1 Hz to 10 Hz			0.6				
I_n Equivalent input noise current	$V_{IC} = 0$, f = 10 kHz	25°C	2.8			2.8			fA/ $\sqrt{\text{Hz}}$	
THD + N Total harmonic distortion plus noise	$V_{O(PP)} = 5\text{ V}$, f = 1 kHz, $R_S = 25\ \Omega$	$A_{VD} = 10$, $R_L = 2\text{ k}\Omega$,	25°C	0.013%			0.013%			
B_1 Unity-gain bandwidth	$V_I = 10\text{ mV}$, $C_L = 25\text{ pF}$,	$R_L = 2\text{ k}\Omega$, See Figure 2	25°C	9.4			9.4			MHz
B_{OM} Maximum output-swing bandwidth	$V_{O(PP)} = 4\text{ V}$, $R_L = 2\text{ k}\Omega$,	$A_{VD} = -1$, $C_L = 25\text{ pF}$	25°C	2.8			2.8			MHz
ϕ_m Phase margin at unity gain	$V_I = 10\text{ mV}$, $C_L = 25\text{ pF}$,	$R_L = 2\text{ k}\Omega$, See Figure 2	25°C	56°			56°			

† Full range is 40°C to 85°C.

TLE208x, TLE208xA, TLE208xY EXCALIBUR HIGH-SPEED JFET-INPUT OPERATIONAL AMPLIFIERS

SLOS182B – FEBRUARY 1997 – REVISED JUNE 2001

TLE2082I electrical characteristics at specified free-air temperature, $V_{CC\pm} = \pm 15\text{ V}$ (unless otherwise noted)

PARAMETER	TEST CONDITIONS	T_A †	TLE2082I			TLE2082AI			UNIT	
			MIN	TYP	MAX	MIN	TYP	MAX		
V_{IO} Input offset voltage	$V_{IC} = 0,$ $R_S = 50\ \Omega$ $V_O = 0,$	25°C	1.1	7		0.7	4	mV		
		Full range			8.5		5.5			
α_{VIO} Temperature coefficient of input offset voltage		Full range	2.4	25		2.4	25	$\mu\text{V}/^\circ\text{C}$		
I_{IO} Input offset current	$V_{IC} = 0,$ $V_O = 0,$ See Figure 4	25°C	6	100		6	100	pA		
		Full range			5		5	nA		
I_{IB} Input bias current		25°C	20	175		20	175	pA		
		Full range			10		10	nA		
V_{ICR} Common-mode input voltage range	$R_S = 50\ \Omega$	25°C	15 to -11	15 to -11.9		15 to -11	15 to -11.9	V		
		Full range	15 to -10.8			15 to -10.8				
V_{OM+} Maximum positive peak output voltage swing	$I_O = -200\ \mu\text{A}$	25°C	13.8	14.1		13.8	14.1	V		
		Full range	13.7			13.7				
	$I_O = -2\ \text{mA}$	25°C	13.5	13.9		13.5	13.9			
		Full range	13.4			13.4				
	$I_O = -20\ \text{mA}$	25°C	11.5	12.3		11.5	12.3			
		Full range	11.5			11.5				
V_{OM-} Maximum negative peak output voltage swing	$I_O = 200\ \mu\text{A}$	25°C	-13.8	-14.2		-13.8	-14.2	V		
		Full range	-13.7			-13.7				
	$I_O = 2\ \text{mA}$	25°C	-13.5	-14		-13.5	-14			
		Full range	-13.4			-13.4				
	$I_O = 20\ \text{mA}$	25°C	-11.5	-12.4		-11.5	-12.4			
		Full range	-11.5			-11.5				
A_{VD} Large-signal differential voltage amplification	$V_O = \pm 10\ \text{V}$	$R_L = 600\ \Omega$	25°C	80	96		80	96	dB	
			Full range	79			79			
		$R_L = 2\ \text{k}\Omega$	25°C	90	109		90	109		
			Full range	89			89			
		$R_L = 10\ \text{k}\Omega$	25°C	95	118		95	118		
			Full range	94			94			
r_i Input resistance	$V_{IC} = 0$	25°C	10^{12}			10^{12}			Ω	
c_i Input capacitance	Common mode	$V_{IC} = 0,$ See Figure 5	25°C	7.5			7.5			pF
	Differential		25°C	2.5			2.5			
z_o Open-loop output impedance	$f = 1\ \text{MHz}$	25°C	80			80			Ω	
CMRR Common-mode rejection ratio	$V_{IC} = V_{ICRmin},$ $V_O = 0,$ $R_S = 50\ \Omega$	25°C	80	98		80	98	dB		
		Full range	79			79				
k_{SVR} Supply-voltage rejection ratio ($\Delta V_{CC\pm} / \Delta V_{IO}$)	$V_{CC\pm} = \pm 5\ \text{V to } \pm 15\ \text{V},$ $V_O = 0,$ $R_S = 50\ \Omega$	25°C	82	99		82	99	dB		
		Full range	80			80				

† Full range is -40°C to 85°C .



TLE208x, TLE208xA, TLE208xY
EXCALIBUR HIGH-SPEED JFET-INPUT
OPERATIONAL AMPLIFIERS

SLOS182B – FEBRUARY 1997 – REVISED JUNE 2001

TLE2082I electrical characteristics at specified free-air temperature, $V_{CC\pm} = \pm 15$ V (unless otherwise noted) (continued)

PARAMETER	TEST CONDITIONS	T_A	TLE2082I			TLE2082AI			UNIT
			MIN	TYP	MAX	MIN	TYP	MAX	
I_{CC} Supply current (both channels)	$V_O = 0$, No load	25°C	2.7	3.1	3.9	2.7	3.1	3.9	mA
		Full range	3.9			3.9			
Crosstalk attenuation	$V_{IC} = 0$, $R_L = 2$ k Ω	25°C	120			120			dB
I_{OS} Short-circuit output current	$V_O = 0$	25°C	$V_{ID} = 1$ V	-30	-45	-30	-45	mA	
			$V_{ID} = -1$ V	30	48	30	48		

TLE2082I operating characteristics at specified free-air temperature, $V_{CC\pm} = \pm 15$ V

PARAMETER	TEST CONDITIONS	T_A †	TLE2082I			TLE2082AI			UNIT
			MIN	TYP	MAX	MIN	TYP	MAX	
SR+ Positive slew rate	$V_{O(PP)} = 10$ V, $A_{VD} = -1$, $R_L = 2$ k Ω , $C_L = 100$ pF, See Figure 1	25°C	28	40		28	40	V/ μ s	
		Full range	22			22			
SR- Negative slew rate		25°C	30	45		30	45	V/ μ s	
		Full range	22			22			
t_s Settling time	$A_{VD} = -1$, 10-V step, $R_L = 1$ k Ω , $C_L = 100$ pF	25°C	To 10 mV	0.4		0.4		μ s	
			To 1 mV	1.5		1.5			
V_n Equivalent input noise voltage	$R_S = 20$ Ω , See Figure 3	25°C	f = 10 Hz	28		28		nV/ \sqrt{Hz}	
			f = 10 kHz	11.6		11.6			
$V_{N(PP)}$ Peak-to-peak equivalent input noise voltage		25°C	f = 10 Hz to 10 kHz	6		6		μ V	
			f = 0.1 Hz to 10 Hz	0.6		0.6			
I_n Equivalent input noise current	$V_{IC} = 0$, f = 10 kHz	25°C	2.8		2.8		fA/ \sqrt{Hz}		
THD + N Total harmonic distortion plus noise	$V_{O(PP)} = 20$ V, $A_{VD} = 10$, f = 1 kHz, $R_L = 2$ k Ω , $R_S = 25$ Ω	25°C	0.008%		0.008%				
B_1 Unity-gain bandwidth	$V_I = 10$ mV, $R_L = 2$ k Ω , $C_L = 25$ pF, See Figure 2	25°C	8	10	8	10	MHz		
B_{OM} Maximum output-swing bandwidth	$V_{O(PP)} = 20$ V, $A_{VD} = -1$, $R_L = 2$ k Ω , $C_L = 25$ pF	25°C	478	637	478	637	kHz		
ϕ_m Phase margin at unity gain	$V_I = 10$ mV, $R_L = 2$ k Ω , $C_L = 25$ pF, See Figure 2	25°C	57°		57°				

† Full range is -40°C to 85°C.



TLE208x, TLE208xA, TLE208xY EXCALIBUR HIGH-SPEED JFET-INPUT OPERATIONAL AMPLIFIERS

SLOS182B – FEBRUARY 1997 – REVISED JUNE 2001

TLE2082M electrical characteristics at specified free-air temperature, $V_{CC\pm} = \pm 5\text{ V}$ (unless otherwise noted)

PARAMETER	TEST CONDITIONS	T_A †	TLE2082M			TLE2082AM			UNIT	
			MIN	TYP	MAX	MIN	TYP	MAX		
V_{IO} Input offset voltage	$V_{IC} = 0, V_O = 0, R_S = 50\ \Omega$	25°C	0.9	7		0.65	4	mV		
		Full range			9.5		6.5			
α_{VIO} Temperature coefficient of input offset voltage		Full range	2.3	25*		2.3	25*	$\mu\text{V}/^\circ\text{C}$		
I_{IO} Input offset current	$V_{IC} = 0, V_O = 0, \text{See Figure 4}$	25°C	5	100		5	100	pA		
		Full range			20		20	nA		
I_{IB} Input bias current		25°C	15	175		15	175	pA		
		Full range			60		60	nA		
V_{ICR} Common-mode input voltage range	$R_S = 50\ \Omega$	25°C	5 to -1	5 to -1.9		5 to -1	5 to -1.9	V		
		Full range	5 to -0.8			5 to -0.8				
V_{OM+} Maximum positive peak output voltage swing	$I_O = -200\ \mu\text{A}$	25°C	3.8	4.1		3.8	4.1	V		
		Full range	3.6			3.6				
	$I_O = -2\ \text{mA}$	25°C	3.5	3.9		3.5	3.9			
		Full range	3.3			3.3				
$I_O = -20\ \text{mA}$	25°C	1.5	2.3		1.5	2.3				
	Full range	1.4			1.4					
V_{OM-} Maximum negative peak output voltage swing	$I_O = 200\ \mu\text{A}$	25°C	-3.8	-4.2		-3.8	-4.2	V		
		Full range	-3.6			-3.6				
	$I_O = 2\ \text{mA}$	25°C	-3.5	-4.1		-3.5	-4.1			
		Full range	-3.3			-3.3				
$I_O = 20\ \text{mA}$	25°C	-1.5	-2.4		-1.5	-2.4				
	Full range	-1.4			-1.4					
A_{VD} Large-signal differential voltage amplification	$V_O = \pm 2.3\ \text{V}$	$R_L = 600\ \Omega$	25°C	80	91		80	91	dB	
			Full range	78			78			
		$R_L = 2\ \text{k}\Omega$	25°C	90	100		90	100		
			Full range	88			88			
		$R_L = 10\ \text{k}\Omega$	25°C	95	106		95	106		
			Full range	93			93			
r_i Input resistance	$V_{IC} = 0$	25°C	10^{12}			10^{12}			Ω	
c_i Input capacitance	Common mode	$V_{IC} = 0, \text{See Figure 5}$	25°C	11			11			pF
	Differential		25°C	2.5			2.5			
z_o Open-loop output impedance	$f = 1\ \text{MHz}$	25°C	80			80			Ω	
CMRR Common-mode rejection ratio	$V_{IC} = V_{ICR\text{min}}, V_O = 0, R_S = 50\ \Omega$	25°C	70	89		70	89	dB		
		Full range	68			68				
k_{SVR} Supply-voltage rejection ratio ($\Delta V_{CC\pm} / \Delta V_{IO}$)	$V_{CC\pm} = \pm 5\ \text{V to } \pm 15\ \text{V}, V_O = 0, R_S = 50\ \Omega$	25°C	82	99		82	99	dB		
		Full range	80			80				

*On products compliant with MIL-PRF-38535, Class B, this parameter is not production tested.

† Full range is -55°C to 125°C .



TLE208x, TLE208xA, TLE208xY
EXCALIBUR HIGH-SPEED JFET-INPUT
OPERATIONAL AMPLIFIERS

SLOS182B – FEBRUARY 1997 – REVISED JUNE 2001

TLE2082M electrical characteristics at specified free-air temperature, $V_{CC\pm} = \pm 5$ V (unless otherwise noted) (continued)

PARAMETER	TEST CONDITIONS	T_A †	TLE2082M			TLE2082AM			UNIT
			MIN	TYP	MAX	MIN	TYP	MAX	
I_{CC} Supply current (both channels)	$V_O = 0$, No load	25°C	2.7	2.9	3.6	2.7	2.9	3.6	mA
		Full range	3.6			3.6			
Crosstalk attenuation	$V_{IC} = 0$, $R_L = 2$ k Ω	25°C	120			120			dB
I_{OS} Short-circuit output current	$V_O = 0$	25°C	$V_{ID} = 1$ V			-35			mA
			$V_{ID} = -1$ V			45			

† Full range is -55°C to 125°C .

TLE2082M operating characteristics at specified free-air temperature, $V_{CC\pm} = \pm 5$ V

PARAMETER	TEST CONDITIONS	T_A †	TLE2082M			TLE2082AM			UNIT	
			MIN	TYP	MAX	MIN	TYP	MAX		
SR+ Positive slew rate	$V_{O(PP)} = \pm 2.3$ V, $A_{VD} = -1$, $R_L = 2$ k Ω , $C_L = 100$ pF, See Figure 1	25°C	35			35			V/ μ s	
		Full range	18*			18*				
SR- Negative slew rate	$V_{O(PP)} = \pm 2.3$ V, $A_{VD} = -1$, $R_L = 2$ k Ω , $C_L = 100$ pF, See Figure 1	25°C	38			38			V/ μ s	
		Full range	18*			18*				
t_s Settling time	$A_{VD} = -1$, 2-V step, $R_L = 1$ k Ω , $C_L = 100$ pF	25°C	To 10 mV			0.25			μ s	
			To 1 mV			0.4				
V_n Equivalent input noise voltage	$R_S = 20$ Ω , See Figure 3	25°C	f = 10 Hz			28			nV/ $\sqrt{\text{Hz}}$	
			f = 10 kHz			11.6				
$V_{N(PP)}$ Peak-to-peak equivalent input noise voltage	$R_S = 20$ Ω , See Figure 3	25°C	f = 10 Hz to 10 kHz			6			μ V	
			f = 0.1 Hz to 10 Hz			0.6				
I_n Equivalent input noise current	$V_{IC} = 0$, f = 10 kHz	25°C	2.8			2.8			fA/ $\sqrt{\text{Hz}}$	
THD + N Total harmonic distortion plus noise	$V_{O(PP)} = 5$ V, f = 1 kHz, $R_S = 25$ Ω	$A_{VD} = 10$, $R_L = 2$ k Ω	25°C	0.013%			0.013%			
B_1 Unity-gain bandwidth	$V_I = 10$ mV, $C_L = 25$ pF,	$R_L = 2$ k Ω , See Figure 2	25°C	9.4			9.4			MHz
B_{OM} Maximum output-swing bandwidth	$V_{O(PP)} = 4$ V, $R_L = 2$ k Ω ,	$A_{VD} = -1$, $C_L = 25$ pF	25°C	2.8			2.8			MHz
ϕ_m Phase margin at unity gain	$V_I = 10$ mV, $C_L = 25$ pF,	$R_L = 2$ k Ω , See Figure 2	25°C	56°			56°			

*On products compliant with MIL-PRF-38535, Class B, this parameter is not production tested.

† Full range is -55°C to 125°C .

TLE208x, TLE208xA, TLE208xY EXCALIBUR HIGH-SPEED JFET-INPUT OPERATIONAL AMPLIFIERS

SLOS182B – FEBRUARY 1997 – REVISED JUNE 2001

TLE2082M electrical characteristics at specified free-air temperature, $V_{CC\pm} = \pm 15$ V (unless otherwise noted)

PARAMETER	TEST CONDITIONS	T_A †	TLE2082M			TLE2082AM			UNIT	
			MIN	TYP	MAX	MIN	TYP	MAX		
V_{IO} Input offset voltage	$V_{IC} = 0, V_O = 0, R_S = 50 \Omega$	25°C	1.1	7		0.7	4	mV		
		Full range			9.5		6.5			
α_{VIO} Temperature coefficient of input offset voltage		Full range	2.4	25*		2.4	25*	$\mu V/^\circ C$		
I_{IO} Input offset current	$V_{IC} = 0, V_O = 0, \text{See Figure 4}$	25°C	6	100		6	100	pA		
		Full range			20		20	nA		
I_{IB} Input bias current		25°C	20	175		20	175	pA		
		Full range			65		65	nA		
V_{ICR} Common-mode input voltage range	$R_S = 50 \Omega$	25°C	15 to -11	15 to -11.9		15 to -11	15 to -11.9	V		
		Full range	15 to -10.8			15 to -10.8				
V_{OM+} Maximum positive peak output voltage swing	$I_O = -200 \mu A$	25°C	13.8	14.1		13.8	14.1	V		
		Full range	13.6			13.6				
	$I_O = -2 \text{ mA}$	25°C	13.5	13.9		13.5	13.9			
		Full range	13.3			13.3				
	$I_O = -20 \text{ mA}$	25°C	11.5	12.3		11.5	12.3			
		Full range	11.4			11.4				
V_{OM-} Maximum negative peak output voltage swing	$I_O = 200 \mu A$	25°C	-13.8	-14.2		-13.8	-14.2	V		
		Full range	-13.6			-13.6				
	$I_O = 2 \text{ mA}$	25°C	-13.5	-14		-13.5	-14			
		Full range	-13.3			-13.3				
	$I_O = 20 \text{ mA}$	25°C	-11.5	-12.4		-11.5	-12.4			
		Full range	-11.4			-11.4				
A_{VD} Large-signal differential voltage amplification	$V_O = \pm 10 \text{ V}$	$R_L = 600 \Omega$	25°C	80	96		80	96	dB	
			Full range	78			78			
		$R_L = 2 \text{ k}\Omega$	25°C	90	109		90	109		
			Full range	88			88			
		$R_L = 10 \text{ k}\Omega$	25°C	95	118		95	118		
			Full range	93			93			
r_i Input resistance	$V_{IC} = 0$	25°C	10^{12}			10^{12}			Ω	
c_i Input capacitance	Common mode	$V_{IC} = 0, \text{See Figure 5}$	25°C	7.5			7.5			pF
	Differential		25°C	2.5			2.5			
z_o Open-loop output impedance	$f = 1 \text{ MHz}$	25°C	80			80			Ω	
CMRR Common-mode rejection ratio	$V_{IC} = V_{ICRmin}, V_O = 0, R_S = 50 \Omega$	25°C	80	98		80	98	dB		
		Full range	78			78				
k_{SVR} Supply-voltage rejection ratio ($\Delta V_{CC\pm} / \Delta V_{IO}$)	$V_{CC\pm} = \pm 5 \text{ V to } \pm 15 \text{ V}, V_O = 0, R_S = 50 \Omega$	25°C	82	99		82	99	dB		
		Full range	80			80				

*On products compliant with MIL-PRF-38535, Class B, this parameter is not production tested.

† Full range is $-55^\circ C$ to $125^\circ C$.



TLE208x, TLE208xA, TLE208xY
EXCALIBUR HIGH-SPEED JFET-INPUT
OPERATIONAL AMPLIFIERS

SLOS182B – FEBRUARY 1997 – REVISED JUNE 2001

TLE2082M electrical characteristics at specified free-air temperature, $V_{CC\pm} = \pm 15$ V (unless otherwise noted) (continued)

PARAMETER	TEST CONDITIONS	T_A †	TLE2082M			TLE2082AM			UNIT	
			MIN	TYP	MAX	MIN	TYP	MAX		
I_{CC}	Supply current (both channels)	$V_O = 0$, No load	25°C	2.7	3.1	3.6	2.7	3.1	3.6	mA
			Full range	3.6			3.6			
	Crosstalk attenuation	$V_{IC} = 0$, $R_L = 2$ k Ω	25°C	120			120			dB
I_{OS}	Short-circuit output current	$V_O = 0$	25°C	$V_{ID} = 1$ V	-30	-45	-30	-45	mA	
				$V_{ID} = -1$ V	30	48	30	48		

† Full range is -55°C to 125°C .

TLE2082M operating characteristics at specified free-air temperature, $V_{CC\pm} = \pm 15$ V

PARAMETER	TEST CONDITIONS	T_A †	TLE2082M			TLE2082AM			UNIT
			MIN	TYP	MAX	MIN	TYP	MAX	
SR+	Positive slew rate	$V_{O(PP)} = 10$ V, $A_{VD} = -1$, $R_L = 2$ k Ω , $C_L = 100$ pF, See Figure 1	25°C	28	40	28	40	V/ μs	
			Full range	20			20		
SR-	Negative slew rate	$V_{O(PP)} = 10$ V, $A_{VD} = -1$, $R_L = 2$ k Ω , $C_L = 100$ pF, See Figure 1	25°C	30	45	30	45	V/ μs	
			Full range	20			20		
t_s	Settling time	$A_{VD} = -1$, 10-V step, $R_L = 1$ k Ω , $C_L = 100$ pF	25°C	To 10 mV	0.4		0.4		μs
				To 1 mV	1.5		1.5		
V_n	Equivalent input noise voltage	$R_S = 20$ Ω , See Figure 3	25°C	f = 10 Hz	28		28		nV/ $\sqrt{\text{Hz}}$
				f = 10 kHz	11.6		11.6		
$V_{N(PP)}$	Peak-to-peak equivalent input noise voltage	$R_S = 20$ Ω , See Figure 3	25°C	f = 10 Hz to 10 kHz	6		6		μV
				f = 0.1 Hz to 10 Hz	0.6		0.6		
I_n	Equivalent input noise current	$V_{IC} = 0$, f = 10 kHz	25°C	2.8			2.8		fA/ $\sqrt{\text{Hz}}$
THD + N	Total harmonic distortion plus noise	$V_{O(PP)} = 20$ V, $A_{VD} = 10$, f = 1 kHz, $R_L = 2$ k Ω , $R_S = 25$ Ω	25°C	0.008%			0.008%		
B_1	Unity-gain bandwidth	$V_I = 10$ mV, $R_L = 2$ k Ω , $C_L = 25$ pF, See Figure 2	25°C	8*	10	8*	10	MHz	
BOM	Maximum output-swing bandwidth	$V_{O(PP)} = 20$ V, $A_{VD} = -1$, $R_L = 2$ k Ω , $C_L = 25$ pF	25°C	478*	637	478*	637	kHz	
ϕ_m	Phase margin at unity gain	$V_I = 10$ mV, $R_L = 2$ k Ω , $C_L = 25$ pF, See Figure 2	25°C	57°			57°		

*On products compliant with MIL-PRF-38535, Class B, this parameter is not production tested.

† Full range is -55°C to 125°C .



TLE208x, TLE208xA, TLE208xY
EXCALIBUR HIGH-SPEED JFET-INPUT
OPERATIONAL AMPLIFIERS

SLOS182B – FEBRUARY 1997 – REVISED JUNE 2001

TLE2082Y electrical characteristics at $V_{CC\pm} = \pm 15\text{ V}$, $T_A = 25^\circ\text{C}$

PARAMETER		TEST CONDITIONS		TLE2082Y			UNIT	
				MIN	TYP	MAX		
V_{IO}	Input offset voltage	$V_{IC} = 0$,	$V_O = 0$,	$R_S = 50\ \Omega$	1.1	6	mV	
I_{IO}	Input offset current	$V_{IC} = 0$,	$V_O = 0$,	See Figure 4	6	100	pA	
I_{IB}	Input bias current				20	175	pA	
V_{ICR}	Common-mode input voltage range	$R_S = 50\ \Omega$		15 to -11	15 to 11.9		V	
V_{OM+}	Maximum positive peak output voltage swing	$I_O = -200\ \mu\text{A}$		13.8	14.1	V		
		$I_O = -2\ \text{mA}$		13.5	13.9			
		$I_O = -20\ \text{mA}$		11.5	12.3			
V_{OM-}	Maximum negative peak output voltage swing	$I_O = 200\ \mu\text{A}$		-13.8	-14.2	V		
		$I_O = 2\ \text{mA}$		-13.5	-14			
		$I_O = 20\ \text{mA}$		-11.5	-12.4			
A_{VD}	Large-signal differential voltage amplification	$V_O = \pm 10\ \text{V}$	$R_L = 600\ \Omega$	80	96	dB		
			$R_L = 2\ \text{k}\Omega$	90	109			
			$R_L = 10\ \text{k}\Omega$	95	118			
r_i	Input resistance	$V_{IC} = 0$		10 ¹²		Ω		
c_i	Input capacitance	Common mode	$V_O = 0$,	See Figure 5	7.5		pF	
		Differential			2.5			
z_o	Open-loop output impedance	$f = 1\ \text{MHz}$		80		Ω		
CMRR	Common-mode rejection ratio	$V_{IC} = V_{ICRmin}$,	$V_O = 0$,	$R_S = 50\ \Omega$	80	98	dB	
k_{SVR}	Supply-voltage rejection ratio ($\Delta V_{CC\pm} / \Delta V_{IO}$)	$V_{CC\pm} = \pm 5\ \text{V}$ to $\pm 15\ \text{V}$,		$V_O = 0$,	82	99	dB	
I_{CC}	Supply current (both channels)	$V_O = 0$,	No load		2.7	3.1	3.9	mA
I_{OS}	Short-circuit output current	$V_O = 0$	$V_{ID} = 1\ \text{V}$	-30	-45	mA		
			$V_{ID} = -1\ \text{V}$	30	48			



TLE208x, TLE208xA, TLE208xY
EXCALIBUR HIGH-SPEED JFET-INPUT
OPERATIONAL AMPLIFIERS

SLOS182B – FEBRUARY 1997 – REVISED JUNE 2001

TLE2084C electrical characteristics at specified free-air temperature, $V_{CC\pm} = \pm 5$ V (unless otherwise noted)

PARAMETER	TEST CONDITIONS	T_A †	TLE2084C			TLE2084AC			UNIT	
			MIN	TYP	MAX	MIN	TYP	MAX		
V_{IO} Input offset voltage	$V_{IC} = 0, V_O = 0,$ $R_S = 50 \Omega$	25°C	-1.6	7		-0.5	4	mV		
		Full range			9.1		6.1			
α_{VIO} Temperature coefficient of input offset voltage		Full range	10.1	30		10.1	30	$\mu V/^\circ C$		
I_{IO} Input offset current	$V_{IC} = 0, V_O = 0,$ See Figure 4	25°C	15	100		15	100	pA		
		Full range			1.4		1.4	nA		
I_{IB} Input bias current		25°C	20	175		20	175	pA		
		Full range			5		5	nA		
V_{ICR} Common-mode input voltage range	$R_S = 50 \Omega$	25°C	5 to -1	5 to -1.9		5 to -1	5 to -1.9	V		
		Full range	5 to -0.9			5 to -0.9				
V_{OM+} Maximum positive peak output voltage swing	$I_O = -200 \mu A$	25°C	3.8	4.1		3.8	4.1	V		
		Full range	3.7			3.7				
	$I_O = -2$ mA	25°C	3.5	3.9		3.5	3.9			
		Full range	3.4			3.4				
	$I_O = -20$ mA	25°C	1.5	2.3		1.5	2.3			
		Full range	1.5			1.5				
V_{OM-} Maximum negative peak output voltage swing	$I_O = 200 \mu A$	25°C	-3.8	-4.2		-3.8	-4.2	V		
		Full range	-3.7			-3.7				
	$I_O = 2$ mA	25°C	-3.5	-4.1		-3.5	-4.1			
		Full range	-3.4			-3.4				
	$I_O = 20$ mA	25°C	-1.5	-2.4		-1.5	-2.4			
		Full range	-1.5			-1.5				
A_{VD} Large-signal differential voltage amplification	$V_O = \pm 2.3$ V	$R_L = 600 \Omega$	25°C	80	91		80	91	dB	
			Full range	79			79			
		$R_L = 2$ k Ω	25°C	90	100		90	100		
			Full range	89			89			
		$R_L = 10$ k Ω	25°C	95	106		95	106		
			Full range	94			94			
r_i Input resistance	$V_{IC} = 0$	25°C	10^{12}			10^{12}			Ω	
c_i Input capacitance	$V_{IC} = 0,$ See Figure 5	Common mode	25°C	11			11			pF
		Differential	25°C	2.5			2.5			
z_o Open-loop output impedance	$f = 1$ MHz	25°C	80			80			Ω	
CMRR Common-mode rejection ratio	$V_{IC} = V_{ICRmin},$ $V_O = 0, R_S = 50 \Omega$	25°C	70	89		70	89	dB		
		Full range	68			68				
k_{SVR} Supply-voltage rejection ratio ($\Delta V_{CC\pm} / \Delta V_{IO}$)	$V_{CC\pm} = \pm 5$ V to ± 15 V, $V_O = 0, R_S = 50 \Omega$	25°C	82	99		82	99	dB		
		Full range	80			80				
I_{CC} Supply current (four amplifiers)	$V_O = 0,$ No load	25°C	5.2	6.3	7.5	5.2	6.3	7.5	mA	
		Full range			7.5			7.5		
a_x Crosstalk attenuation	$V_{IC} = 0, R_L = 2$ k Ω	25°C	120			120			dB	

† Full range is 0°C to 70°C.



TLE208x, TLE208xA, TLE208xY
EXCALIBUR HIGH-SPEED JFET-INPUT
OPERATIONAL AMPLIFIERS

SLOS182B – FEBRUARY 1997 – REVISED JUNE 2001

TLE2084C electrical characteristics at specified free-air temperature, $V_{CC\pm} = \pm 5\text{ V}$ (unless otherwise noted) (continued)

PARAMETER	TEST CONDITIONS	T_A †	TLE2084C			TLE2084AC			UNIT
			MIN	TYP	MAX	MIN	TYP	MAX	
I_{OS}	Short-circuit output current $V_O = 0$	25°C	$V_{ID} = 1\text{ V}$			-35			mA
			$V_{ID} = -1\text{ V}$			45			

† Full range is 0°C to 70°C.

TLE2084C operating characteristics at specified free-air temperature, $V_{CC\pm} = \pm 5\text{ V}$

PARAMETER	TEST CONDITIONS	T_A †	TLE2084C			TLE2084AC			UNIT
			MIN	TYP	MAX	MIN	TYP	MAX	
SR+	Positive slew rate $V_{O(PP)} = \pm 2.3\text{ V}$, $A_{VD} = -1$, $R_L = 2\text{ k}\Omega$, $C_L = 100\text{ pF}$, See Figure 1	25°C	35			35			$\text{V}/\mu\text{s}$
		Full range	22			22			
SR-	Negative slew rate	25°C	38			38			$\text{V}/\mu\text{s}$
		Full range	22			22			
t_s	Settling time $A_{VD} = -1$, 2-V step, $R_L = 1\text{ k}\Omega$, $C_L = 100\text{ pF}$	25°C	To 10 mV			0.25			μs
			To 1 mV			0.4			
V_n	Equivalent input noise voltage $R_S = 20\ \Omega$, See Figure 3	25°C	f = 10 Hz			28			$\text{nV}/\sqrt{\text{Hz}}$
			f = 10 kHz			11.6			
$V_{N(PP)}$	Peak-to-peak equivalent input noise voltage	25°C	f = 10 Hz to 10 kHz			6			μV
			f = 0.1 Hz to 10 Hz			0.6			
I_n	Equivalent input noise current $V_{IC} = 0$, f = 10 kHz	25°C	2.8			2.8			$\text{fA}/\sqrt{\text{Hz}}$
THD + N	Total harmonic distortion plus noise $V_{O(PP)} = 5\text{ V}$, f = 1 kHz, $R_S = 25\ \Omega$, $A_{VD} = 10$, $R_L = 2\text{ k}\Omega$	25°C	0.013%			0.013%			
B_1	Unity-gain bandwidth $V_I = 10\text{ mV}$, $C_L = 25\text{ pF}$, $R_L = 2\text{ k}\Omega$, See Figure 2	25°C	9.4			9.4			MHz
BOM	Maximum output-swing bandwidth $V_{O(PP)} = 4\text{ V}$, $R_L = 2\text{ k}\Omega$, $A_{VD} = -1$, $C_L = 25\text{ pF}$	25°C	2.8			2.8			MHz
ϕ_m	Phase margin at unity gain $V_I = 10\text{ mV}$, $C_L = 25\text{ pF}$, $R_L = 2\text{ k}\Omega$, See Figure 2	25°C	56°			56°			

† Full range is 0°C to 70°C.



TLE208x, TLE208xA, TLE208xY
EXCALIBUR HIGH-SPEED JFET-INPUT
OPERATIONAL AMPLIFIERS

SLOS182B – FEBRUARY 1997 – REVISED JUNE 2001

TLE2084C electrical characteristics at specified free-air temperature, $V_{CC\pm} = \pm 15$ V (unless otherwise noted)

PARAMETER	TEST CONDITIONS	T_A †	TLE2084C			TLE2084AC			UNIT	
			MIN	TYP	MAX	MIN	TYP	MAX		
V_{IO} Input offset voltage	$V_{IC} = 0, V_O = 0, R_S = 50 \Omega$	25°C	-1.6	7		-0.5	4	mV		
		Full range			9.1		6.1			
α_{VIO} Temperature coefficient of input offset voltage		Full range	10.1	30		10.1	30	$\mu V/^\circ C$		
I_{IO} Input offset current	$V_{IC} = 0, V_O = 0, \text{See Figure 4}$	25°C	15	100		15	100	pA		
		Full range			1.4		1.4	nA		
I_{IB} Input bias current		25°C	25	175		25	175	pA		
		Full range			5		5	nA		
V_{ICR} Common-mode input voltage range	$R_S = 50 \Omega$	25°C	15 to -11	15 to -11.9		15 to -11	15 to -11.9	V		
		Full range	15 to -10.9			15 to -10.9				
V_{OM+} Maximum positive peak output voltage swing	$I_O = -200 \mu A$	25°C	13.8	14.1		13.8	14.1	V		
		Full range	13.7			13.7				
	$I_O = -2 \text{ mA}$	25°C	13.5	13.9		13.5	13.9			
		Full range	13.4			13.4				
	$I_O = -20 \text{ mA}$	25°C	11.5	12.3		11.5	12.3			
		Full range	11.5			11.5				
V_{OM-} Maximum negative peak output voltage swing	$I_O = 200 \mu A$	25°C	-13.8	-14.2		-13.8	-14.2	V		
		Full range	-13.7			-13.7				
	$I_O = 2 \text{ mA}$	25°C	-13.7	-14		-13.7	-14			
		Full range	-13.6			-13.6				
	$I_O = 20 \text{ mA}$	25°C	-11.5	-12.4		-11.5	-12.4			
		Full range	-11.5			-11.5				
A_{VD} Large-signal differential voltage amplification	$V_O = \pm 10 \text{ V}$	$R_L = 600 \Omega$	25°C	80	96		80	96	dB	
			Full range	79			79			
		$R_L = 2 \text{ k}\Omega$	25°C	90	109		90	109		
			Full range	89			89			
		$R_L = 10 \text{ k}\Omega$	25°C	95	118		95	118		
			Full range	94			94			
r_i Input resistance	$V_{IC} = 0$	25°C	10^{12}			10^{12}			Ω	
c_i Input capacitance	$V_{IC} = 0, \text{See Figure 5}$	Common mode	25°C	7.5			7.5			pF
		Differential	25°C	2.5			2.5			
z_o Open-loop output impedance	$f = 1 \text{ MHz}$	25°C	80			80			Ω	
CMRR Common-mode rejection ratio	$V_{IC} = V_{ICRmin}, V_O = 0, R_S = 50 \Omega$	25°C	80	98		80	98	dB		
		Full range	79			79				
k_{SVR} Supply-voltage rejection ratio ($\Delta V_{CC\pm}/\Delta V_{IO}$)	$V_{CC\pm} = \pm 5 \text{ V to } \pm 15 \text{ V}, V_O = 0, R_S = 50 \Omega$	25°C	82	99		82	99	dB		
		Full range	81			81				
I_{CC} Supply current (four amplifiers)	$V_O = 0, \text{No load}$	25°C	5.2	6.5	7.5	5.2	6.5	7.5	mA	
		Full range			7.5			7.5		
a_x Crosstalk attenuation	$V_{IC} = 0, R_L = 2 \text{ k}\Omega$	25°C	120			120			dB	

† Full range is 0°C to 70°C.



TLE208x, TLE208xA, TLE208xY
EXCALIBUR HIGH-SPEED JFET-INPUT
OPERATIONAL AMPLIFIERS

SLOS182B – FEBRUARY 1997 – REVISED JUNE 2001

TLE2084C electrical characteristics at specified free-air temperature, $V_{CC\pm} = \pm 15\text{ V}$ (unless otherwise noted) (continued)

PARAMETER	TEST CONDITIONS	T_A †	TLE2084C			TLE2084AC			UNIT
			MIN	TYP	MAX	MIN	TYP	MAX	
I_{OS}	Short-circuit output current $V_O = 0$	25°C	$V_{ID} = 1\text{ V}$			$V_{ID} = 1\text{ V}$			mA
			$V_{ID} = -1\text{ V}$			$V_{ID} = -1\text{ V}$			

† Full range is 0°C to 70°C.

TLE2084C operating characteristics at specified free-air temperature, $V_{CC\pm} = \pm 15\text{ V}$

PARAMETER	TEST CONDITIONS	T_A †	TLE2084C			TLE2084AC			UNIT
			MIN	TYP	MAX	MIN	TYP	MAX	
SR+	Positive slew rate	25°C	25			25			V/μs
			40			40			
SR-	Negative slew rate	25°C	22			22			V/μs
			30			30			
t_s	Settling time	25°C	0.4			0.4			μs
			1.5			1.5			
V_n	Equivalent input noise voltage	25°C	28			28			nV/√Hz
			11.6			11.6			
$V_{N(PP)}$	Peak-to-peak equivalent input noise voltage	25°C	6			6			μV
			0.6			0.6			
I_n	Equivalent input noise current	25°C	2.8			2.8			fA/√Hz
THD + N	Total harmonic distortion plus noise	25°C	0.008%			0.008%			
B_1	Unity-gain bandwidth	25°C	8			8			MHz
B_{OM}	Maximum output-swing bandwidth	25°C	478			478			kHz
ϕ_m	Phase margin at unity gain	25°C	57°			57°			

† Full range is 0°C to 70°C.



TLE208x, TLE208xA, TLE208xY
EXCALIBUR HIGH-SPEED JFET-INPUT
OPERATIONAL AMPLIFIERS

SLOS182B – FEBRUARY 1997 – REVISED JUNE 2001

TLE2084M electrical characteristics at specified free-air temperature, $V_{CC\pm} = \pm 5\text{ V}$ (unless otherwise noted)

PARAMETER	TEST CONDITIONS	T_A †	TLE2084M			TLE2084AM			UNIT	
			MIN	TYP	MAX	MIN	TYP	MAX		
V_{IO} Input offset voltage	$V_{IC} = 0, V_O = 0, R_S = 50\ \Omega$	25°C	-1.6	7		-0.5	4	mV		
		Full range			12.5		9.5			
α_{VIO} Temperature coefficient of input offset voltage		Full range	10.1	30*		10.1	30*	$\mu\text{V}/^\circ\text{C}$		
I_{IO} Input offset current	$V_{IC} = 0, V_O = 0, \text{See Figure 4}$	25°C	15	100		15	100	pA		
		Full range			20		20	nA		
I_{IB} Input bias current		25°C	20	175		20	175	pA		
		Full range			65		65	nA		
V_{ICR} Common-mode input voltage range	$R_S = 50\ \Omega$	25°C	5 to -1	5 to -1.9		5 to -1	5 to -1.9	V		
		Full range	5 to -0.8			5 to -0.8				
V_{OM+} Maximum positive peak output voltage swing	$I_O = -200\ \mu\text{A}$	25°C	3.8	4.1		3.8	4.1	V		
		Full range	3.6			3.6				
	$I_O = -2\ \text{mA}$	25°C	3.5	3.9		3.5	3.9			
		Full range	3.3			3.3				
	$I_O = -20\ \text{mA}$	25°C	1.5	2.3		1.5	2.3			
		Full range	1.4			1.4				
V_{OM-} Maximum negative peak output voltage swing	$I_O = 200\ \mu\text{A}$	25°C	-3.8	-4.2		-3.8	-4.2	V		
		Full range	-3.6			-3.6				
	$I_O = 2\ \text{mA}$	25°C	-3.5	-4.1		-3.5	-4.1			
		Full range	-3.3			-3.3				
	$I_O = 20\ \text{mA}$	25°C	-1.5	-2.4		-1.5	-2.4			
		Full range	-1.4			-1.4				
A_{VD} Large-signal differential voltage amplification	$V_O = \pm 2.3\ \text{V}$	$R_L = 600\ \Omega$	25°C	80	91		80	91	dB	
			Full range	78			78			
		$R_L = 2\ \text{k}\Omega$	25°C	90	100		90	100		
			Full range	88			88			
		$R_L = 10\ \text{k}\Omega$	25°C	95	106		95	106		
			Full range	93			93			
r_i Input resistance	$V_{IC} = 0$	25°C	10^{12}			10^{12}			Ω	
c_i Input capacitance	$V_{IC} = 0, \text{See Figure 5}$	Common mode	25°C	11			11			pF
		Differential	25°C	2.5			2.5			
z_o Open-loop output impedance	$f = 1\ \text{MHz}$	25°C	80			80			Ω	
CMRR Common-mode rejection ratio	$V_{IC} = V_{ICR\text{min}}, V_O = 0, R_S = 50\ \Omega$	25°C	70	89		70	89	dB		
		Full range	68			68				
k_{SVR} Supply-voltage rejection ratio ($\Delta V_{CC\pm} / \Delta V_{IO}$)	$V_{CC\pm} = \pm 5\ \text{V to } \pm 15\ \text{V}, V_O = 0, R_S = 50\ \Omega$	25°C	82	99		82	99	dB		
		Full range	80			80				
I_{CC} Supply current (four amplifiers)	$V_O = 0, \text{No load}$	25°C	5.2	6.3	7.5	5.2	6.3	7.5	mA	
		Full range			7.5			7.5		
a_x Crosstalk attenuation	$V_{IC} = 0, R_L = 2\ \text{k}\Omega$	25°C	120			120			dB	

*On products compliant with MIL-PRF-38535, Class B, this parameter is not production tested.

† Full range is -55°C to 125°C .



TLE208x, TLE208xA, TLE208xY EXCALIBUR HIGH-SPEED JFET-INPUT OPERATIONAL AMPLIFIERS

SLOS182B – FEBRUARY 1997 – REVISED JUNE 2001

TLE2084M electrical characteristics at specified free-air temperature, $V_{CC\pm} = \pm 5\text{ V}$ (unless otherwise noted) (continued)

PARAMETER	TEST CONDITIONS	T_A	TLE2084M			TLE2084AM			UNIT
			MIN	TYP	MAX	MIN	TYP	MAX	
I_{OS}	Short-circuit output current $V_O = 0$	25°C	$V_{ID} = 1\text{ V}$			-35			mA
			$V_{ID} = -1\text{ V}$			45			

TLE2084M operating characteristics at specified free-air temperature, $V_{CC\pm} = \pm 5\text{ V}$

PARAMETER	TEST CONDITIONS	T_A †	TLE2084M			TLE2084AM			UNIT
			MIN	TYP	MAX	MIN	TYP	MAX	
SR+	Positive slew rate	25°C	35			35			V/ μ s
			Full range			18*			
SR-	Negative slew rate	25°C	38			38			V/ μ s
			Full range			18*			
t_s	Settling time	25°C	To 10 mV			0.25			μ s
			To 1 mV			0.4			
V_n	Equivalent input noise voltage	25°C	f = 10 Hz			28			nV/ $\sqrt{\text{Hz}}$
			f = 10 kHz			11.6			
$V_{N(PP)}$	Peak-to-peak equivalent input noise voltage	25°C	f = 10 Hz to 10 kHz			6			μ V
			f = 0.1 Hz to 10 Hz			0.6			
I_n	Equivalent input noise current	25°C	2.8			2.8			fA/ $\sqrt{\text{Hz}}$
THD + N	Total harmonic distortion plus noise	25°C	0.013%			0.013%			
B_1	Unity-gain bandwidth	25°C	9.4			9.4			MHz
BOM	Maximum output-swing bandwidth	25°C	2.8			2.8			MHz
ϕ_m	Phase margin at unity gain	25°C	56°			56°			

*On products compliant with MIL-PRF-38535, Class B, this parameter is not production tested.

† Full range is -55°C to 125°C.



TLE208x, TLE208xA, TLE208xY
EXCALIBUR HIGH-SPEED JFET-INPUT
OPERATIONAL AMPLIFIERS

SLOS182B – FEBRUARY 1997 – REVISED JUNE 2001

TLE2084M electrical characteristics at specified free-air temperature, $V_{CC\pm} = \pm 15$ V (unless otherwise noted)

PARAMETER	TEST CONDITIONS	T_A †	TLE2084M			TLE2084AM			UNIT
			MIN	TYP	MAX	MIN	TYP	MAX	
V_{IO} Input offset voltage	$V_{IC} = 0, V_O = 0, R_S = 50 \Omega$	25°C	-1.6	7		-0.5	4	mV	
		Full range			12.5		7.5		
α_{VIO} Temperature coefficient of input offset voltage		Full range	10.1	30*		10.1	30*	$\mu V/^\circ C$	
I_{IO} Input offset current	$V_{IC} = 0, V_O = 0, \text{See Figure 4}$	25°C	15	100		15	100	pA	
		Full range			20		20	nA	
I_{IB} Input bias current		25°C	25	175		25	175	pA	
		Full range			65		65	nA	
V_{ICR} Common-mode input voltage range	$R_S = 50 \Omega$	25°C	15 to -11	15 to -11.9		15 to -11	15 to -11.9	V	
		Full range	15 to -10.8			15 to -10.8			
V_{OM+} Maximum positive peak output voltage swing	$I_O = -200 \mu A$	25°C	13.8	14.1		13.8	14.1	V	
		Full range	13.6			13.6			
	$I_O = -2 \text{ mA}$	25°C	13.5	13.9		13.5	13.9		
		Full range	13.3			13.3			
	$I_O = -20 \text{ mA}$	25°C	11.5	12.3		11.5	12.3		
		Full range	11.4			11.4			
V_{OM-} Maximum negative peak output voltage swing	$I_O = 200 \mu A$	25°C	-13.8	-14.2		-13.8	-14.2	V	
		Full range	-13.6			-13.6			
	$I_O = 2 \text{ mA}$	25°C	-13.5	-14		-13.5	-14		
		Full range	-13.3			-13.3			
	$I_O = 20 \text{ mA}$	25°C	-11.5	-12.4		-11.5	-12.4		
		Full range	-11.4			-11.4			
A_{VD} Large-signal differential voltage amplification	$V_O = \pm 10 \text{ V}$	$R_L = 600 \Omega$	25°C	80	96		80	96	dB
			Full range	78			78		
		$R_L = 2 \text{ k}\Omega$	25°C	90	109		90	109	
			Full range	88			88		
		$R_L = 10 \text{ k}\Omega$	25°C	95	118		95	118	
			Full range	93			93		
r_i Input resistance	$V_{IC} = 0$	25°C		10^{12}		10^{12}	Ω		
c_i Input capacitance	$V_{IC} = 0, \text{See Figure 5}$	Common mode	25°C	7.5		7.5	pF		
		Differential	25°C	2.5		2.5			
z_o Open-loop output impedance	$f = 1 \text{ MHz}$	25°C		80		80	Ω		
CMRR Common-mode rejection ratio	$V_{IC} = V_{ICRmin}, V_O = 0, R_S = 50 \Omega$	25°C	80	98		80	98	dB	
		Full range	78			78			
k_{SVR} Supply-voltage rejection ratio ($\Delta V_{CC\pm}/\Delta V_{IO}$)	$V_{CC\pm} = \pm 5 \text{ V to } \pm 15 \text{ V}, V_O = 0, R_S = 50 \Omega$	25°C	82	99		82	99	dB	
		Full range	80			80			
I_{CC} Supply current (four amplifiers)	$V_O = 0, \text{No load}$	25°C	5.2	6.5	7.5	5.2	6.5	7.5	mA
		Full range			7.5			7.5	
a_x Crosstalk attenuation	$V_{IC} = 0, R_L = 2 \text{ k}\Omega$	25°C		120		120	dB		

*On products compliant with MIL-PRF-38535, Class B, this parameter is not production tested.

† Full range is $-55^\circ C$ to $125^\circ C$.



TLE208x, TLE208xA, TLE208xY
EXCALIBUR HIGH-SPEED JFET-INPUT
OPERATIONAL AMPLIFIERS

SLOS182B – FEBRUARY 1997 – REVISED JUNE 2001

TLE2084M electrical characteristics at specified free-air temperature, $V_{CC\pm} = \pm 15\text{ V}$ (unless otherwise noted) (continued)

PARAMETER	TEST CONDITIONS	T_A	TLE2084M			TLE2084AM			UNIT
			MIN	TYP	MAX	MIN	TYP	MAX	
I_{OS}	Short-circuit output current $V_O = 0$	25°C	$V_{ID} = 1\text{ V}$			$V_{ID} = 1\text{ V}$			mA
			$V_{ID} = -1\text{ V}$			$V_{ID} = -1\text{ V}$			

TLE2084M operating characteristics at specified free-air temperature, $V_{CC\pm} = \pm 15\text{ V}$

PARAMETER	TEST CONDITIONS	T_A †	TLE2084M			TLE2084AM			UNIT
			MIN	TYP	MAX	MIN	TYP	MAX	
SR+	Positive slew rate	25°C	Full range			Full range			$V/\mu\text{s}$
			25			40			
SR-	Negative slew rate	25°C	Full range			Full range			$V/\mu\text{s}$
			30			45			
t_s	Settling time	25°C	To 10 mV			To 10 mV			μs
			To 1 mV			To 1 mV			
V_n	Equivalent input noise voltage	25°C	f = 10 Hz			f = 10 Hz			$\text{nV}/\sqrt{\text{Hz}}$
			f = 10 kHz			f = 10 kHz			
$V_{N(PP)}$	Peak-to-peak equivalent input noise voltage	25°C	f = 10 Hz to 10 kHz			f = 10 Hz to 10 kHz			μV
			f = 0.1 Hz to 10 Hz			f = 0.1 Hz to 10 Hz			
I_n	Equivalent input noise current	25°C	f = 10 kHz			f = 10 kHz			$\text{fA}/\sqrt{\text{Hz}}$
THD + N	Total harmonic distortion plus noise	25°C	0.008%			0.008%			
B_1	Unity-gain bandwidth	25°C	8*	10	8*	10		MHz	
B_{OM}	Maximum output-swing bandwidth	25°C	478*	637	478*	637		kHz	
ϕ_m	Phase margin at unity gain	25°C	57°			57°			

*On products compliant with MIL-PRF-38535, Class B, this parameter is not production tested.

† Full range is -55°C to 125°C .



TLE208x, TLE208xA, TLE208xY
EXCALIBUR HIGH-SPEED JFET-INPUT
OPERATIONAL AMPLIFIERS

SLOS182B – FEBRUARY 1997 – REVISED JUNE 2001

TLE2084Y electrical characteristics at $V_{CC\pm} = \pm 15\text{ V}$, $T_A = 25^\circ\text{C}$ (unless otherwise noted)

PARAMETER		TEST CONDITIONS		TLE2084Y			UNIT
				MIN	TYP	MAX	
V_{IO}	Input offset voltage	$V_{IC} = 0$, $R_S = 50\ \Omega$	$V_O = 0$,			7	mV
I_{IO}	Input offset current	$V_{IC} = 0$,	$V_O = 0$,		15	100	pA
I_{IB}	Input bias current	See Figure 4			25	175	pA
V_{ICR}	Common-mode input voltage range	$R_S = 50\ \Omega$		15 to -11	15 to 11.9		V
V_{OM+}	Maximum positive peak output voltage swing	$I_O = -200\ \mu\text{A}$		13.8	14.1		V
		$I_O = -2\ \text{mA}$		13.5	13.9		
		$I_O = -20\ \text{mA}$		11.5	12.3		
V_{OM-}	Maximum negative peak output voltage swing	$I_O = 200\ \mu\text{A}$		-13.8	-14.2		V
		$I_O = 2\ \text{mA}$		-13.5	-14		
		$I_O = 20\ \text{mA}$		-11.5	-12.4		
A_{VD}	Large-signal differential voltage amplification	$V_O = \pm 10\ \text{V}$	$R_L = 600\ \Omega$	80	96		dB
			$R_L = 2\ \text{k}\Omega$	90	109		
			$R_L = 10\ \text{k}\Omega$	95	118		
r_i	Input resistance	$V_{IC} = 0$		10 ¹²			Ω
c_i	Input capacitance	$V_{IC} = 0$, See Figure 5	Common mode	7.5			pF
			Differential	2.5			
z_o	Open-loop output impedance	$f = 1\ \text{MHz}$		80			Ω
CMRR	Common-mode rejection ratio	$V_{IC} = V_{ICRmin}$, $R_S = 50\ \Omega$	$V_O = 0$,	80	98		dB
k_{SVR}	Supply-voltage rejection ratio ($\Delta V_{CC\pm} / \Delta V_{IO}$)	$V_{CC\pm} = \pm 5\ \text{V}$ to $\pm 15\ \text{V}$, $V_O = 0$, $R_S = 50\ \Omega$		82	99		dB
I_{CC}	Supply current (four amplifiers)	$V_O = 0$,	No load	5.2	6.5	7.5	mA
I_{OS}	Short-circuit output current	$V_O = 0$	$V_{ID} = 1\ \text{V}$	-30	-45		mA
			$V_{ID} = -1\ \text{V}$	30	48		



TLE208x, TLE208xA, TLE208xY EXCALIBUR HIGH-SPEED JFET-INPUT OPERATIONAL AMPLIFIERS

SLOS182B – FEBRUARY 1997 – REVISED JUNE 2001

PARAMETER MEASUREMENT INFORMATION

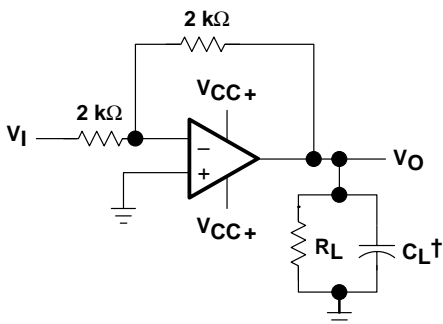

† Includes fixture capacitance

Figure 1. Slew-Rate Test Circuit



† Includes fixture capacitance

Figure 2. Unity-Gain Bandwidth and Phase-Margin Test Circuit

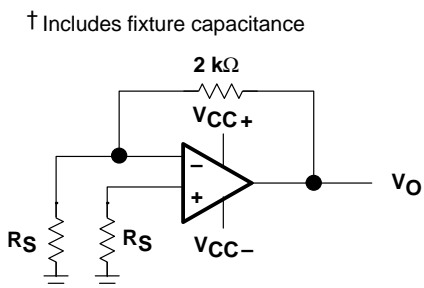

† Includes fixture capacitance

Figure 3. Noise-Voltage Test Circuit

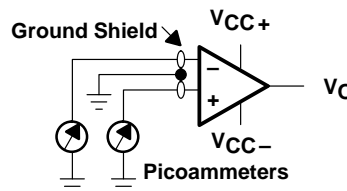

Figure 4. Input-Bias and Offset-Current Test Circuit

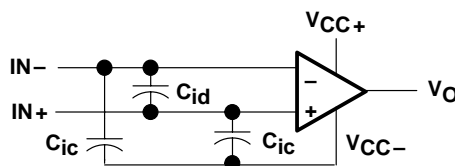

Figure 5. Internal Input Capacitance

typical values

Typical values presented in this data sheet represent the median (50% point) of device parametric performance.

input bias and offset current

At the picoampere bias-current level typical of the TLE208x and TLE208xA, accurate measurement of the bias becomes difficult. Not only does this measurement require a picoammeter, but test socket leakages can easily exceed the actual device bias currents. To accurately measure these small currents, Texas Instruments uses a two-step process. The socket leakage is measured using picoammeters with bias voltages applied but with no device in the socket. The device is then inserted in the socket and a second test is performed that measures both the socket leakage and the device input bias current. The two measurements are then subtracted algebraically to determine the bias current of the device.

TYPICAL CHARACTERISTICS

Table of Graphs

			FIGURE
V_{IO}	Input offset voltage	Distribution	6, 7, 8
α_{VIO}	Input offset voltage temperature coefficient	Distribution	9, 10, 11
I_{IO}	Input offset current	vs Free-air temperature	12 – 15
I_{IB}	Input bias current	vs Free-air temperature vs Supply voltage	12 – 15 16
V_{ICR}	Common-mode input voltage range	vs Free-air temperature	17
V_{ID}	Differential input voltage	vs Output voltage	18, 19
V_{OM+}	Maximum positive peak output voltage	vs Output current vs Free-air temperature vs Supply voltage	20, 21 24, 25 26
V_{OM-}	Maximum negative peak output voltage	vs Output current vs Free-air temperature vs Supply voltage	22, 23 24, 25 26
$V_{O(PP)}$	Maximum peak-to-peak output voltage	vs Frequency	27
V_O	Output voltage	vs Settling time	28
A_{VD}	Large-signal differential voltage amplification	vs Load resistance vs Free-air temperature	29 30, 31
A_{VD}	Small-signal differential voltage amplification	vs Frequency	32, 33
$CMRR$	Common-mode rejection ratio	vs Frequency vs Free-air temperature	34 35
k_{SVR}	Supply-voltage rejection ratio	vs Frequency vs Free-air temperature	36 37
I_{CC}	Supply current	vs Supply voltage vs Free-air temperature vs Differential input voltage	38, 39, 40 41, 42, 43 44 – 49
I_{OS}	Short-circuit output current	vs Supply voltage vs Elapsed time vs Free-air temperature	50 51 52
SR	Slew rate	vs Free-air temperature vs Load resistance vs Differential input voltage	53, 54 55 56
V_n	Equivalent input noise voltage	vs Frequency	57
V_n	Input-referred noise voltage	vs Noise bandwidth frequency Over a 10-second time interval	58 59
	Third-octave spectral noise density	vs Frequency bands	60
$THD + N$	Total harmonic distortion plus noise	vs Frequency	61, 62
B_1	Unity-gain bandwidth	vs Load capacitance	63
	Gain-bandwidth product	vs Free-air temperature vs Supply voltage	64 65
	Gain margin	vs Load capacitance	66
ϕ_m	Phase margin	vs Free-air temperature vs Supply voltage vs Load capacitance	67 68 69
	Phase shift	vs Frequency	32, 33

TLE208x, TLE208xA, TLE208xY
EXCALIBUR HIGH-SPEED JFET-INPUT
OPERATIONAL AMPLIFIERS

SLOS182B – FEBRUARY 1997 – REVISED JUNE 2001

TYPICAL CHARACTERISTICS

Table of Graphs (Continued)

		FIGURE
Noninverting large-signal pulse response	vs Time	70
Small-signal pulse response	vs Time	71
z_o	Closed-loop output impedance vs Frequency	72
a_x	Crosstalk attenuation vs Frequency	73

**DISTRIBUTION OF TLE2081
INPUT OFFSET VOLTAGE**

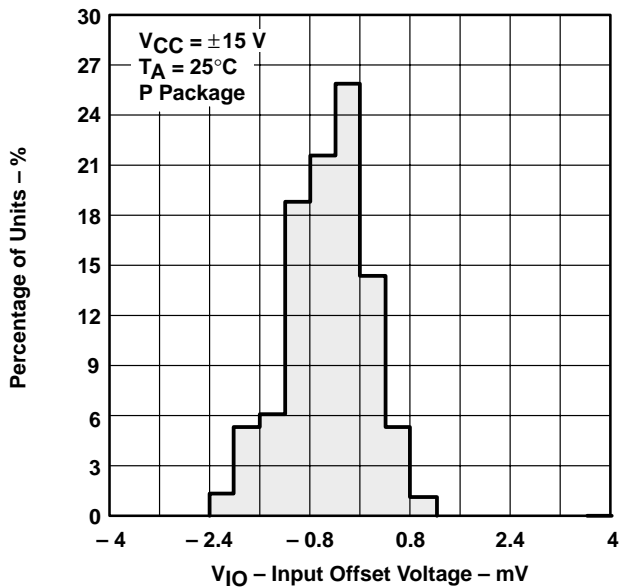

Figure 6

**DISTRIBUTION OF TLE2082
INPUT OFFSET VOLTAGE**

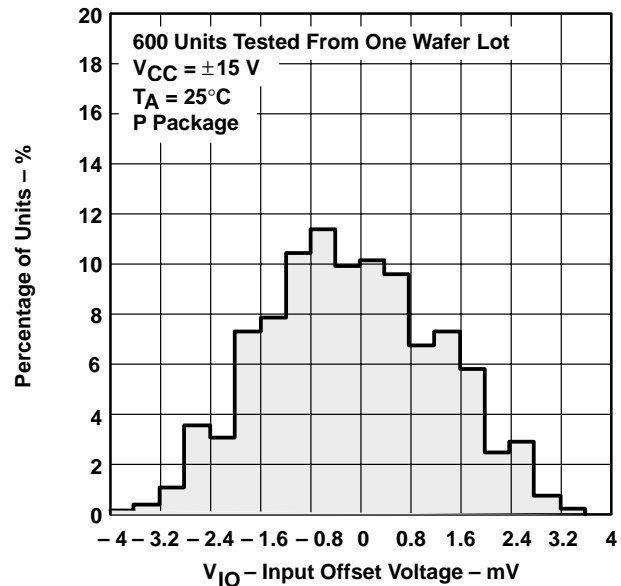

Figure 7

TYPICAL CHARACTERISTICS

DISTRIBUTION OF TLE2084
INPUT OFFSET VOLTAGE



Figure 8

DISTRIBUTION OF TLE2081 INPUT OFFSET
VOLTAGE TEMPERATURE COEFFICIENT



Figure 9

DISTRIBUTION OF TLE2082 INPUT OFFSET
VOLTAGE TEMPERATURE COEFFICIENT

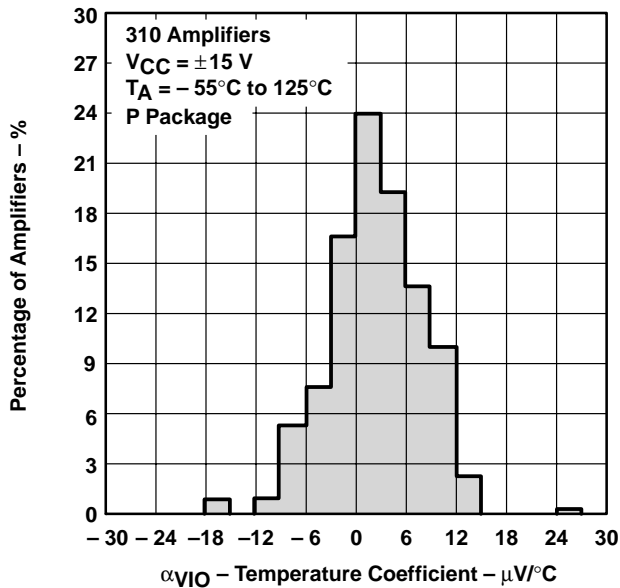

Figure 10

DISTRIBUTION OF TLE2084 INPUT OFFSET
VOLTAGE TEMPERATURE COEFFICIENT



Figure 11

TLE208x, TLE208xA, TLE208xY
EXCALIBUR HIGH-SPEED JFET-INPUT
OPERATIONAL AMPLIFIERS

SLOS182B – FEBRUARY 1997 – REVISED JUNE 2001

TYPICAL CHARACTERISTICS†

TLE2081 AND TLE2082
INPUT BIAS CURRENT AND INPUT OFFSET CURRENT
vs
FREE-AIR TEMPERATURE

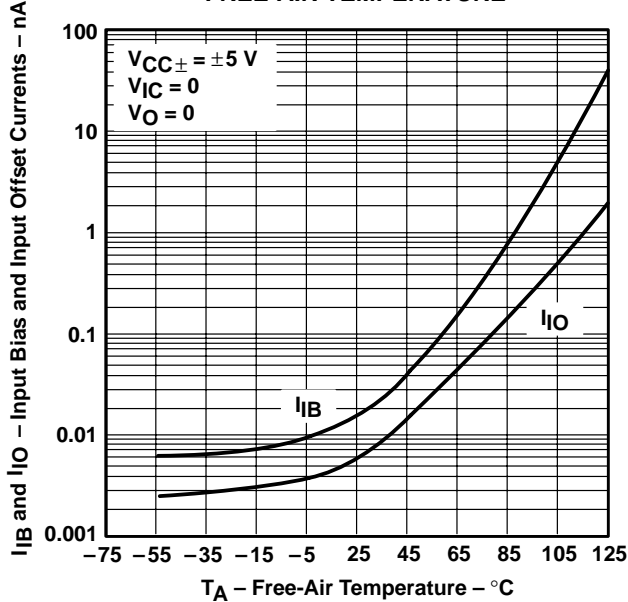

Figure 12

TLE2084
INPUT BIAS CURRENT AND INPUT OFFSET CURRENT
vs
FREE-AIR TEMPERATURE

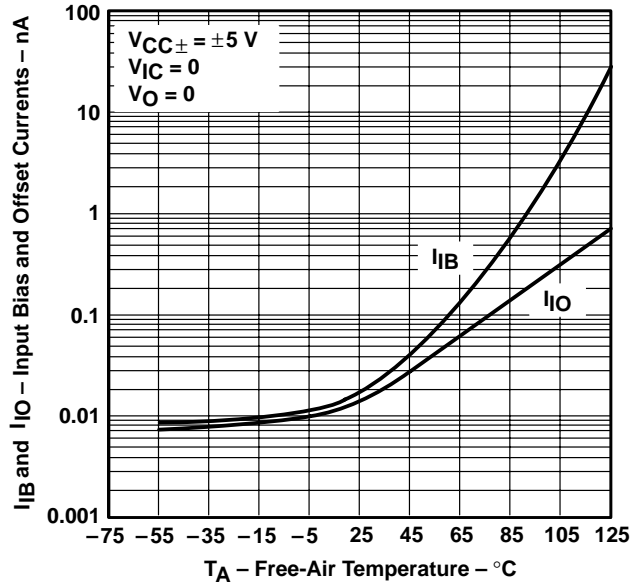

Figure 13

TLE2081 AND TLE2082
INPUT BIAS CURRENT AND INPUT OFFSET CURRENT
vs
FREE-AIR TEMPERATURE

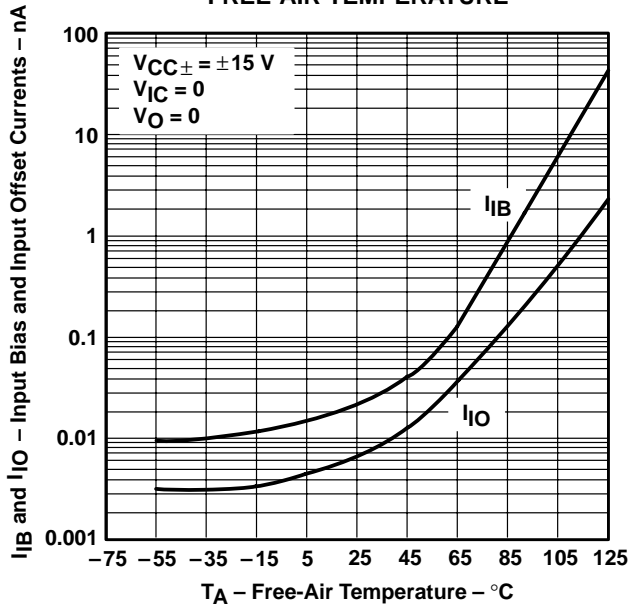

Figure 14

TLE2084
INPUT BIAS CURRENT AND INPUT OFFSET CURRENT
vs
FREE-AIR TEMPERATURE

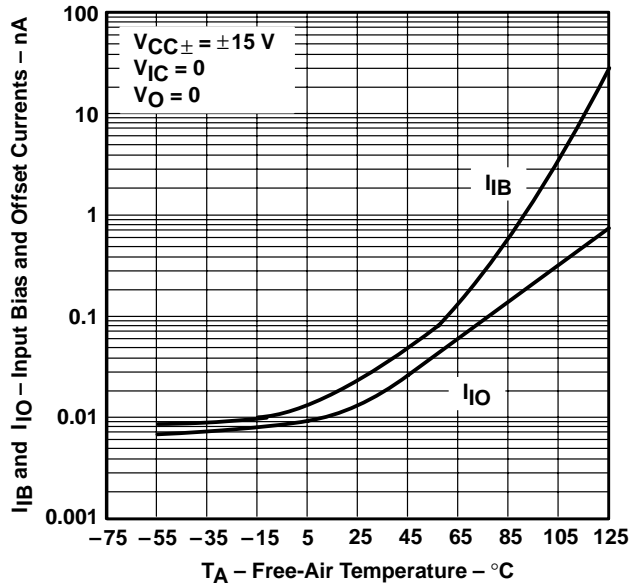
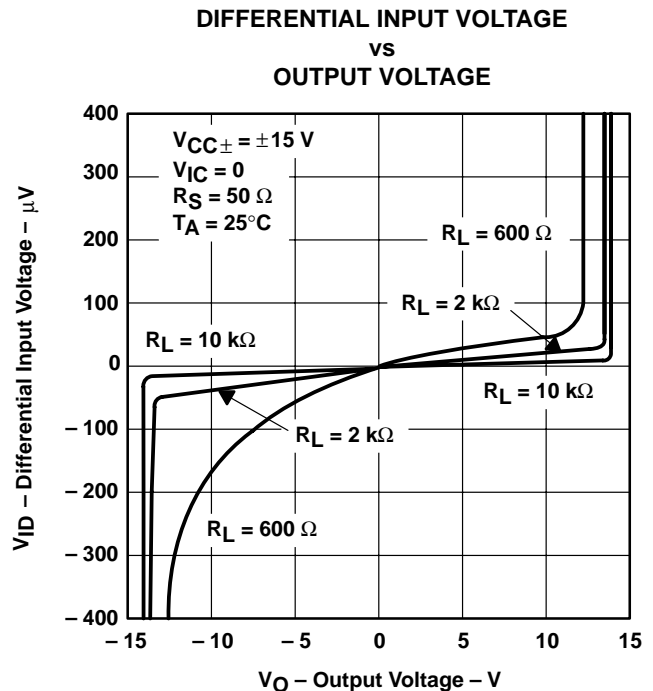
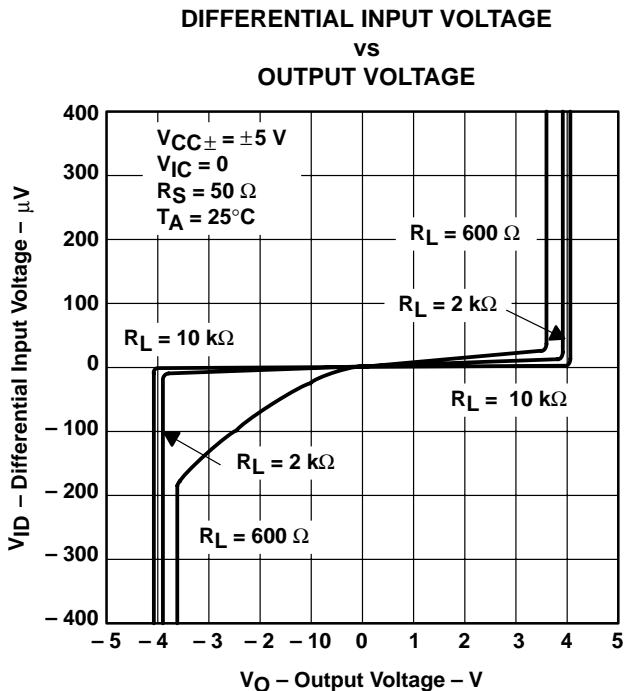
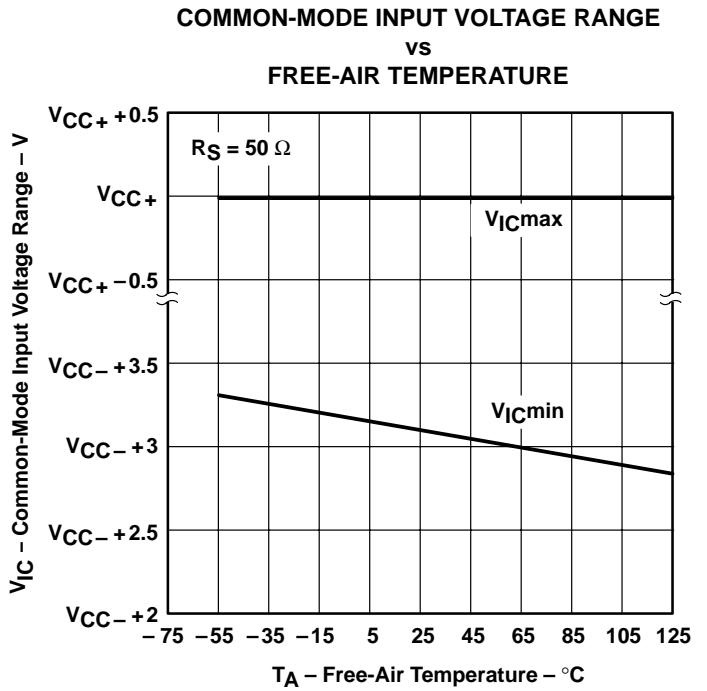
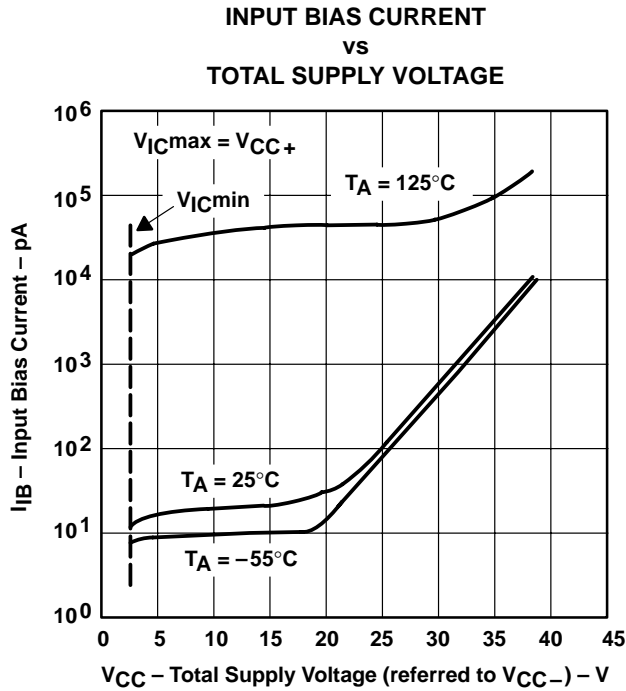

Figure 15

† Data at high and low temperatures are applicable only within the rated operating free-air temperature ranges of the various devices.



TYPICAL CHARACTERISTICS†



† Data at high and low temperatures are applicable only within the rated operating free-air temperature ranges of the various devices.

TLE208x, TLE208xA, TLE208xY EXCALIBUR HIGH-SPEED JFET-INPUT OPERATIONAL AMPLIFIERS

SLOS182B – FEBRUARY 1997 – REVISED JUNE 2001

TYPICAL CHARACTERISTICS†

**TLE2081 AND TLE2082
MAXIMUM POSITIVE PEAK OUTPUT VOLTAGE
vs
OUTPUT CURRENT**

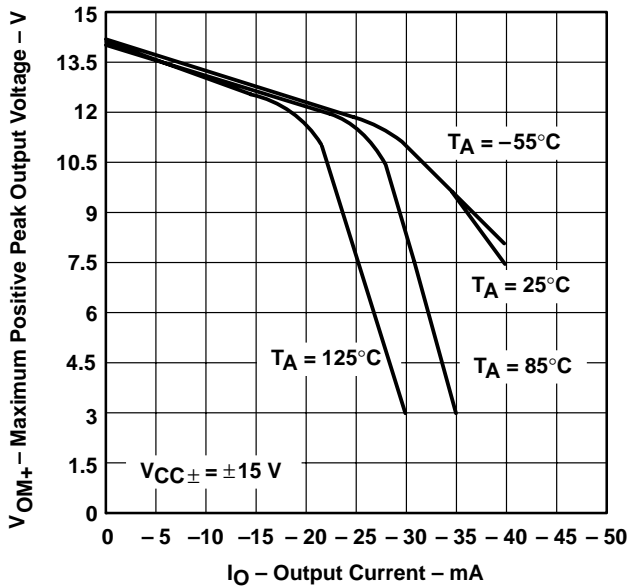

Figure 20

**TLE2084
MAXIMUM POSITIVE PEAK OUTPUT VOLTAGE
vs
OUTPUT CURRENT**

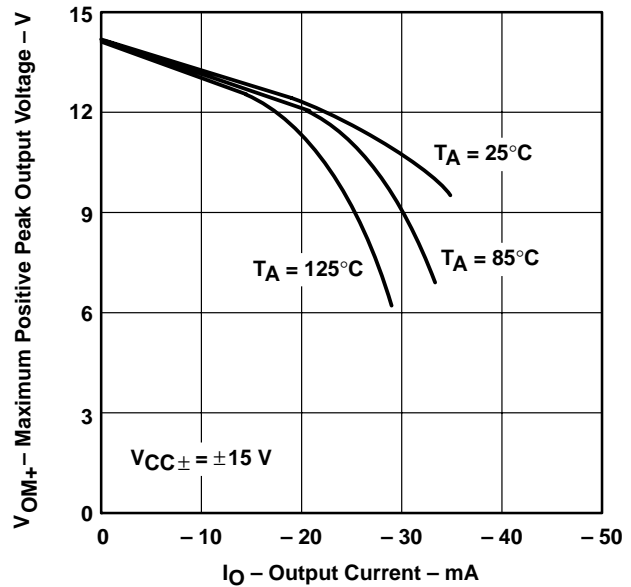

Figure 21

**TLE2081 AND TLE2082
MAXIMUM NEGATIVE PEAK OUTPUT VOLTAGE
vs
OUTPUT CURRENT**

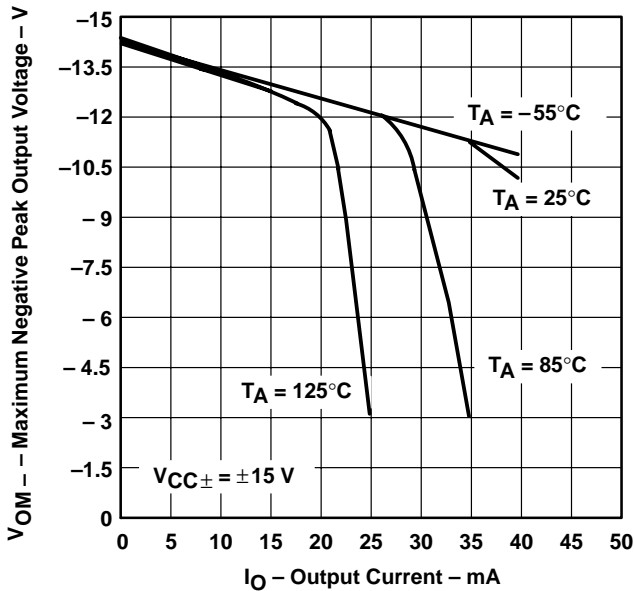

Figure 22

**TLE2084
MAXIMUM NEGATIVE PEAK OUTPUT VOLTAGE
vs
OUTPUT CURRENT**

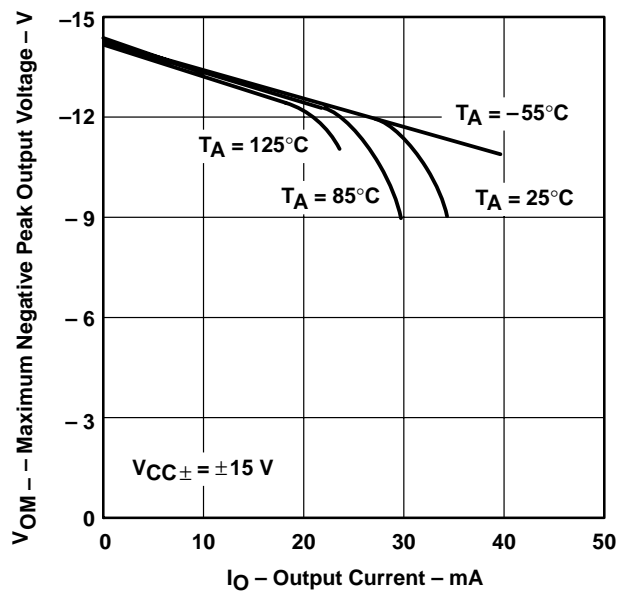

Figure 23

† Data at high and low temperatures are applicable only within the rated operating free-air temperature ranges of the various devices.



TYPICAL CHARACTERISTICS†

MAXIMUM PEAK OUTPUT VOLTAGE
vs
FREE-AIR TEMPERATURE

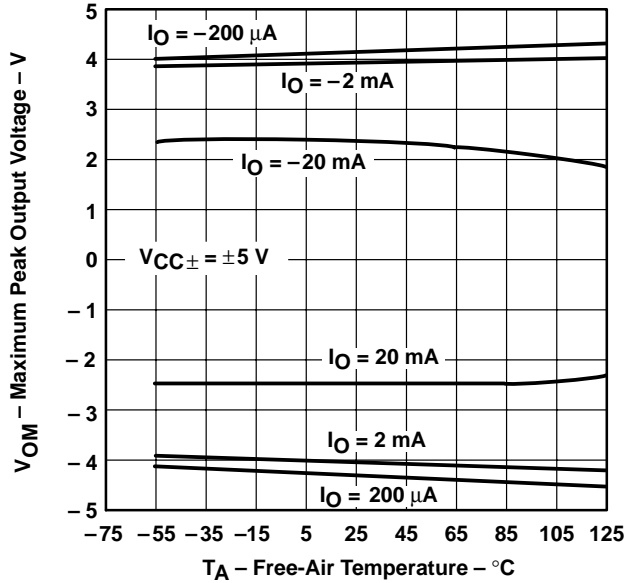

Figure 24

MAXIMUM PEAK OUTPUT VOLTAGE
vs
FREE-AIR TEMPERATURE

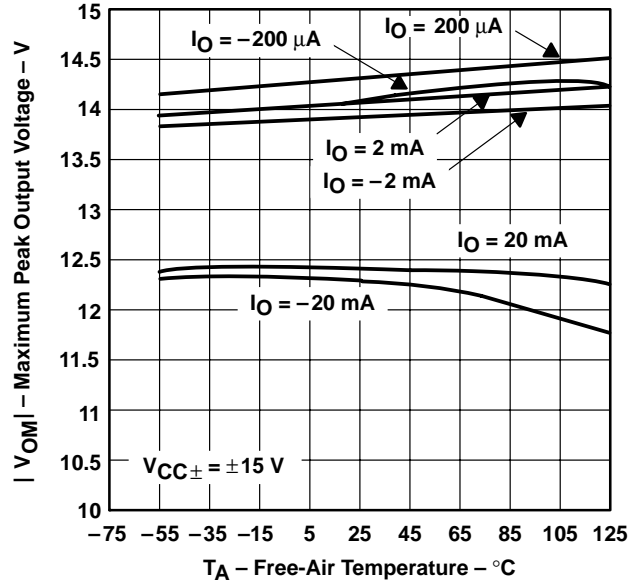

Figure 25

MAXIMUM PEAK OUTPUT VOLTAGE
vs
SUPPLY VOLTAGE



Figure 26

MAXIMUM PEAK-TO-PEAK OUTPUT VOLTAGE
vs
FREQUENCY

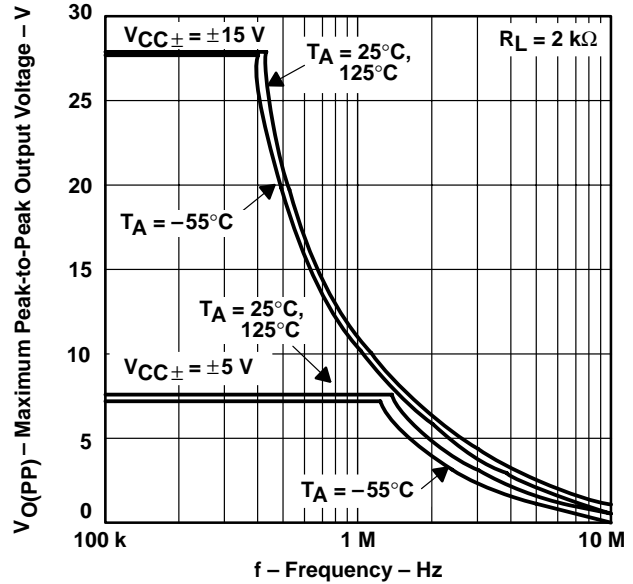

Figure 27

† Data at high and low temperatures are applicable only within the rated operating free-air temperature ranges of the various devices.

TLE208x, TLE208xA, TLE208xY EXCALIBUR HIGH-SPEED JFET-INPUT OPERATIONAL AMPLIFIERS

SLOS182B – FEBRUARY 1997 – REVISED JUNE 2001

TYPICAL CHARACTERISTICS†

OUTPUT VOLTAGE
vs
SETTLING TIME

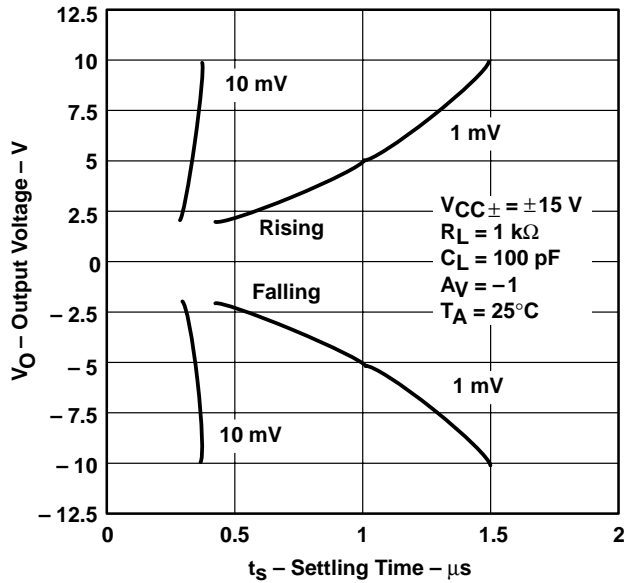

Figure 28

LARGE-SIGNAL DIFFERENTIAL
VOLTAGE AMPLIFICATION
vs
LOAD RESISTANCE

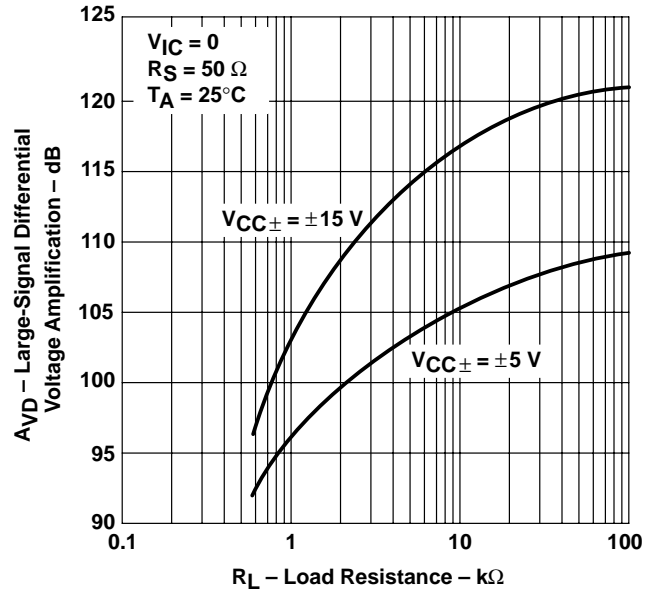

Figure 29

LARGE-SIGNAL DIFFERENTIAL
VOLTAGE AMPLIFICATION
vs
FREE-AIR TEMPERATURE

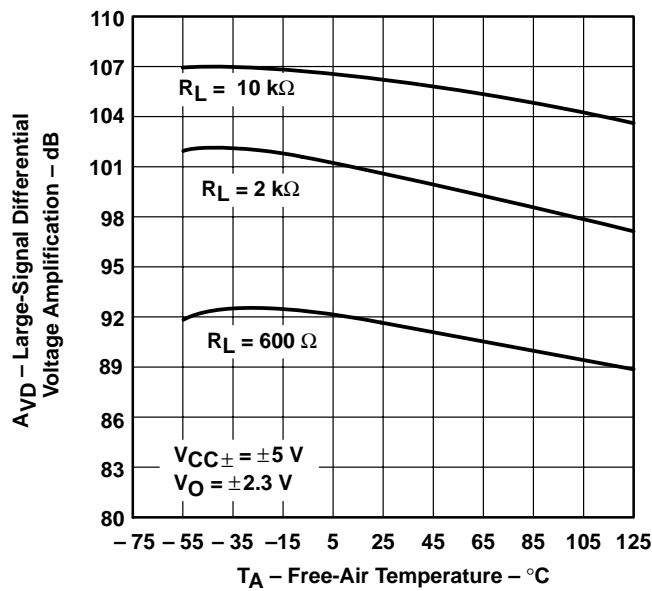

Figure 30

LARGE-SIGNAL DIFFERENTIAL
VOLTAGE AMPLIFICATION
vs
FREE-AIR TEMPERATURE

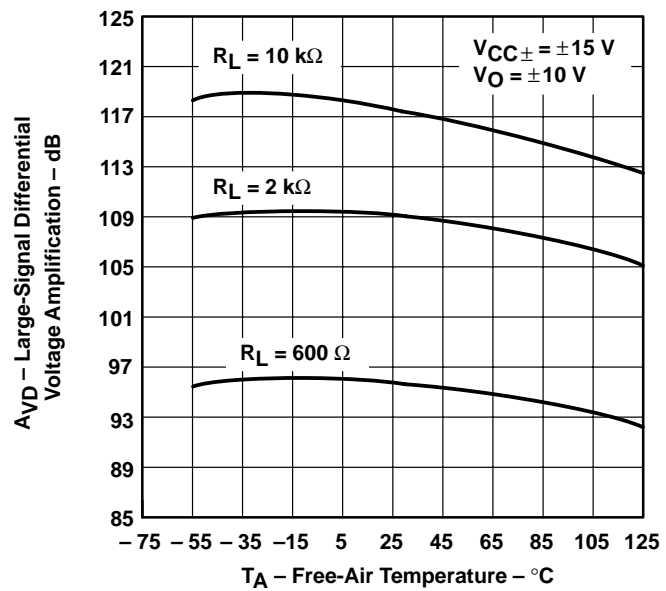

Figure 31

† Data at high and low temperatures are applicable only within the rated operating free-air temperature ranges of the various devices.

TYPICAL CHARACTERISTICS

SMALL-SIGNAL DIFFERENTIAL VOLTAGE
 AMPLIFICATION AND PHASE SHIFT
 vs
 FREQUENCY

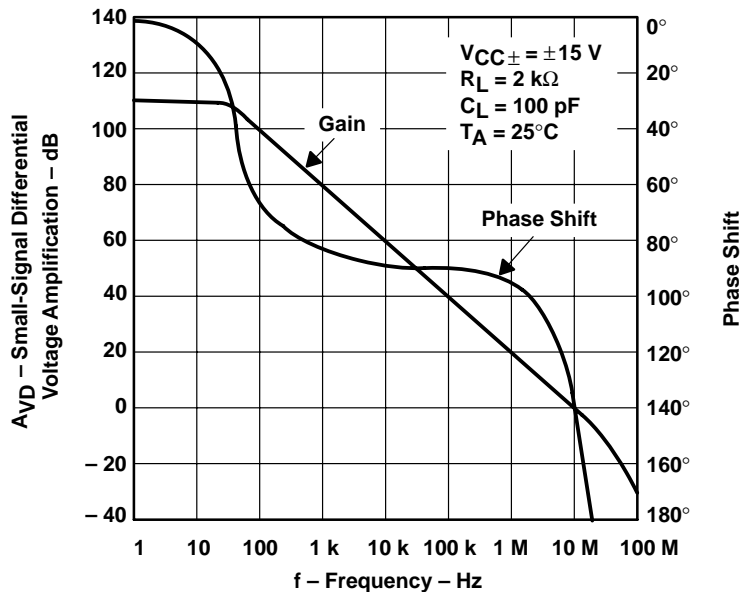

Figure 32

SMALL-SIGNAL DIFFERENTIAL VOLTAGE
 AMPLIFICATION AND PHASE SHIFT
 vs
 FREQUENCY

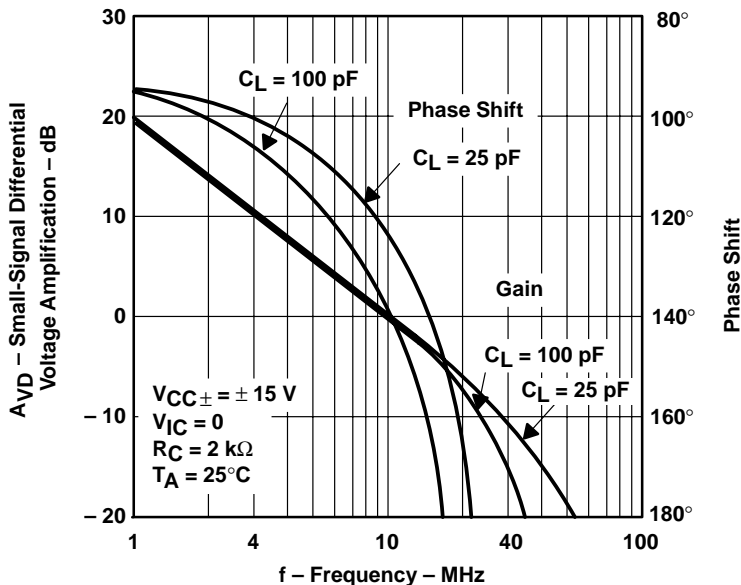

Figure 33

TLE208x, TLE208xA, TLE208xY EXCALIBUR HIGH-SPEED JFET-INPUT OPERATIONAL AMPLIFIERS

SLOS182B – FEBRUARY 1997 – REVISED JUNE 2001

TYPICAL CHARACTERISTICS†



Figure 34



Figure 35



Figure 36



Figure 37

† Data at high and low temperatures are applicable only within the rated operating free-air temperature ranges of the various devices.

TYPICAL CHARACTERISTICS†



† Data at high and low temperatures are applicable only within the rated operating free-air temperature ranges of the various devices.

TLE208x, TLE208xA, TLE208xY EXCALIBUR HIGH-SPEED JFET-INPUT OPERATIONAL AMPLIFIERS

SLOS182B – FEBRUARY 1997 – REVISED JUNE 2001

TYPICAL CHARACTERISTICS†



Figure 42

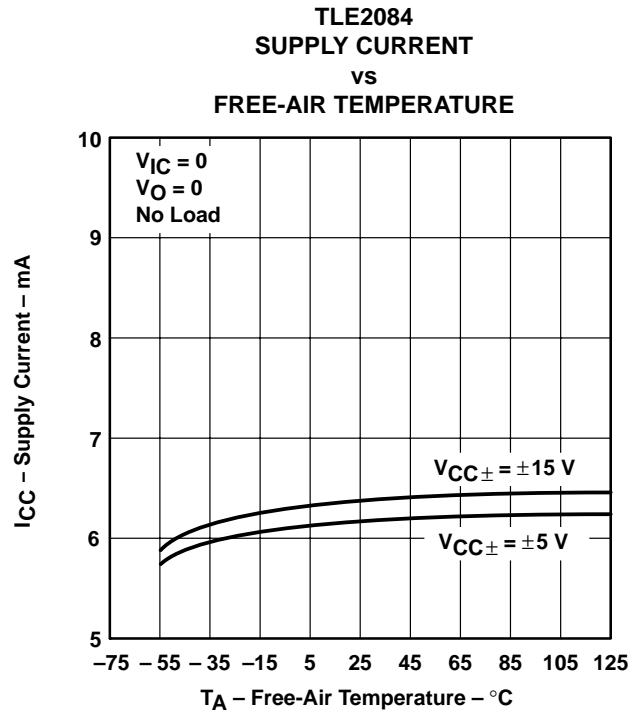

Figure 43

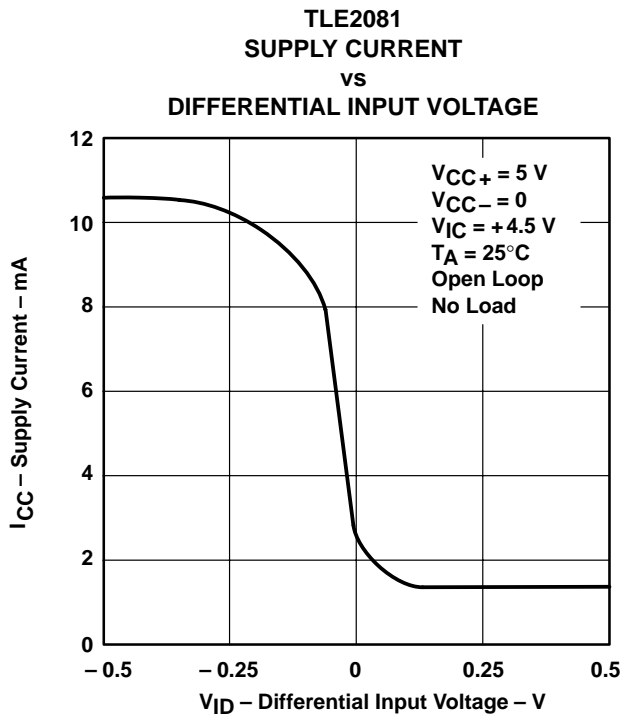

Figure 44

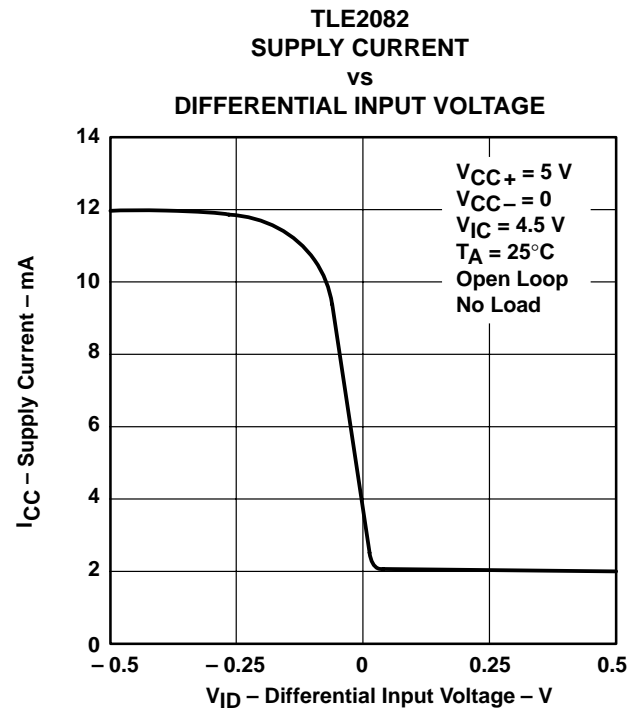
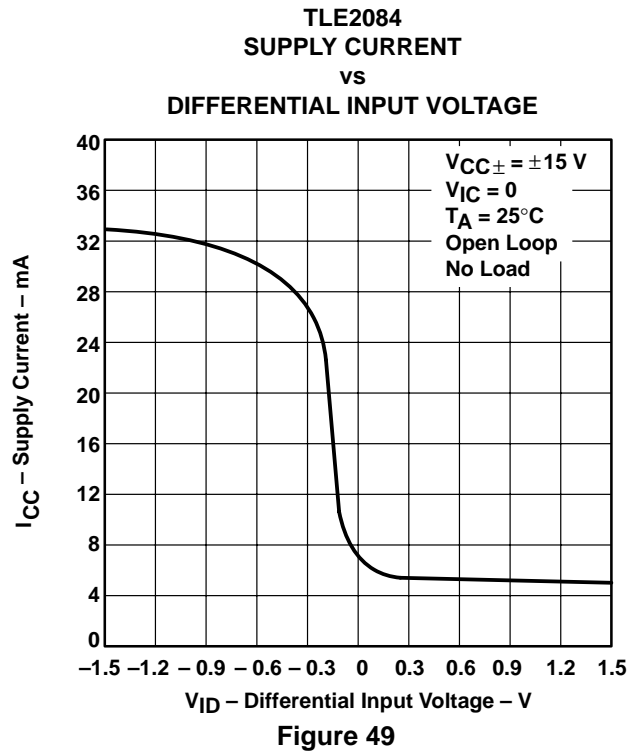
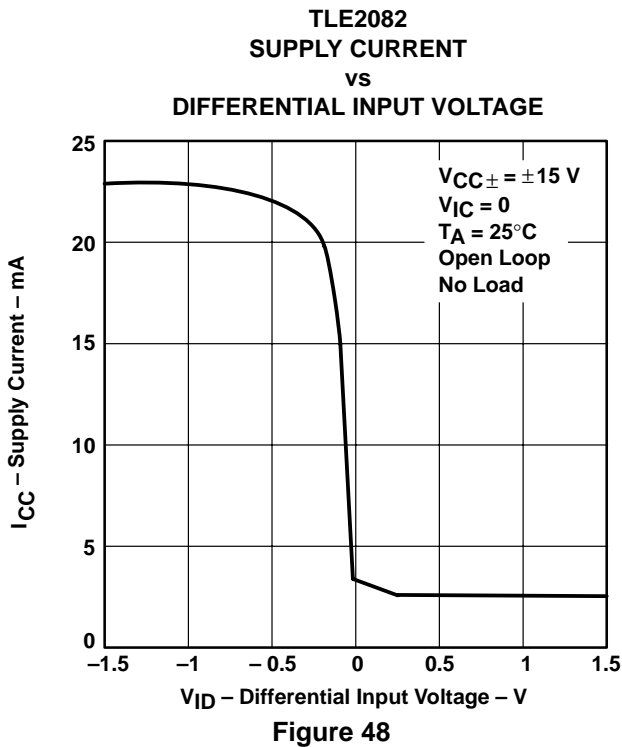
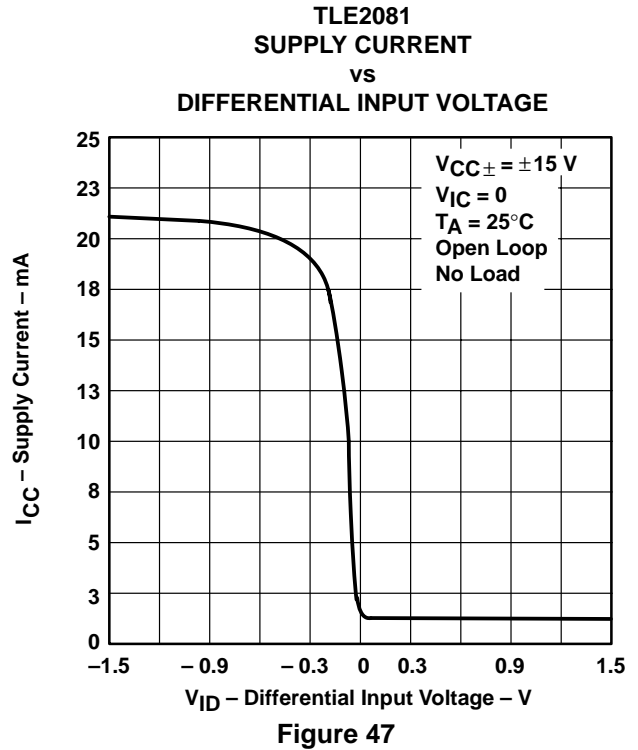

Figure 45

† Data at high and low temperatures are applicable only within the rated operating free-air temperature ranges of the various devices.

TYPICAL CHARACTERISTICS



TLE208x, TLE208xA, TLE208xY EXCALIBUR HIGH-SPEED JFET-INPUT OPERATIONAL AMPLIFIERS

SLOS182B – FEBRUARY 1997 – REVISED JUNE 2001

TYPICAL CHARACTERISTICS†

SHORT-CIRCUIT OUTPUT CURRENT
vs
SUPPLY VOLTAGE

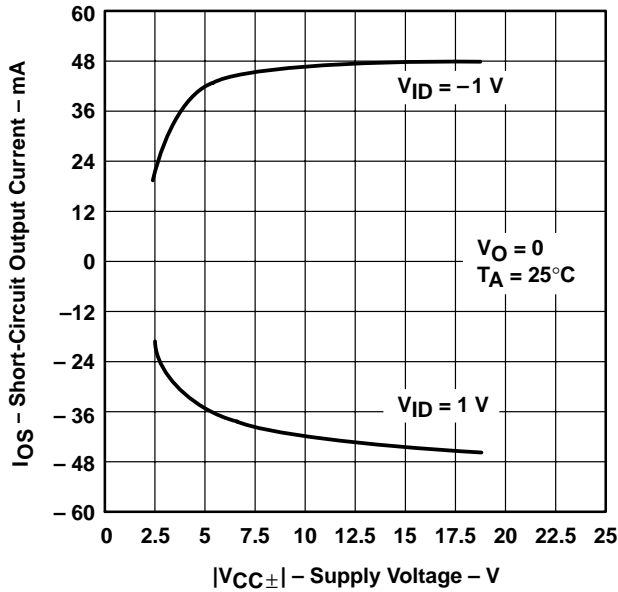

Figure 50

SHORT-CIRCUIT OUTPUT CURRENT
vs
ELAPSED TIME

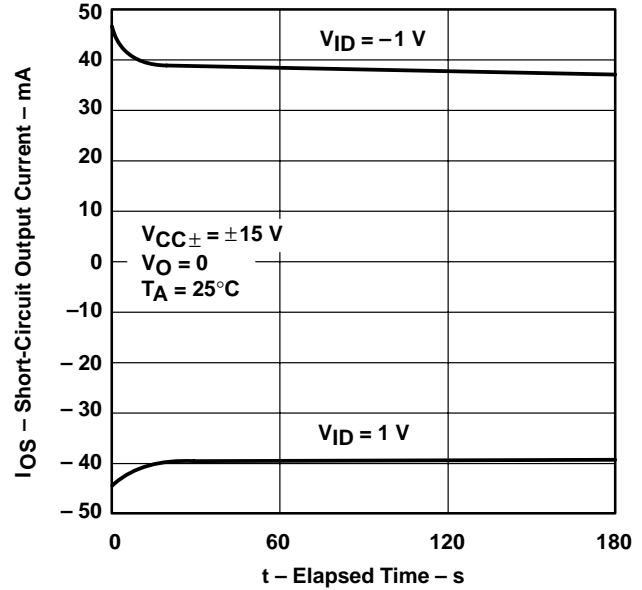

Figure 51

SHORT-CIRCUIT OUTPUT CURRENT
vs
FREE-AIR TEMPERATURE

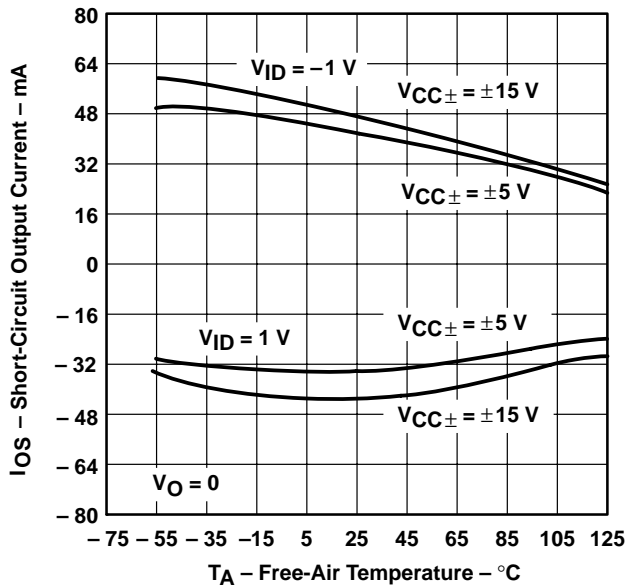

Figure 52

SLEW RATE
vs
FREE-AIR TEMPERATURE

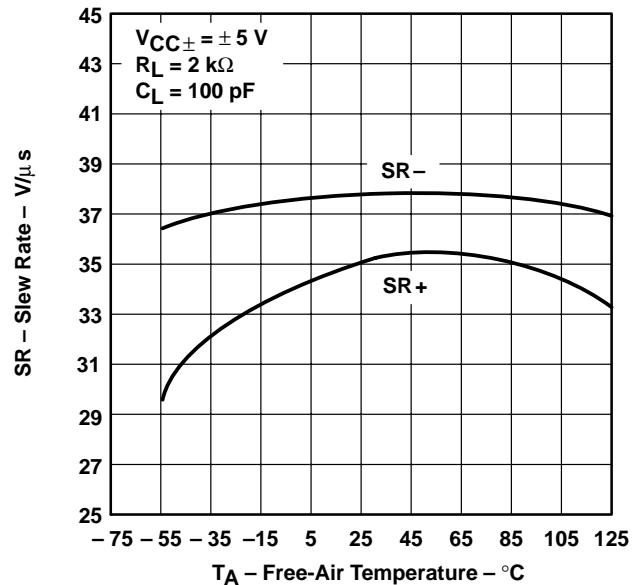

Figure 53

† Data at high and low temperatures are applicable only within the rated operating free-air temperature ranges of the various devices.



TYPICAL CHARACTERISTICS†

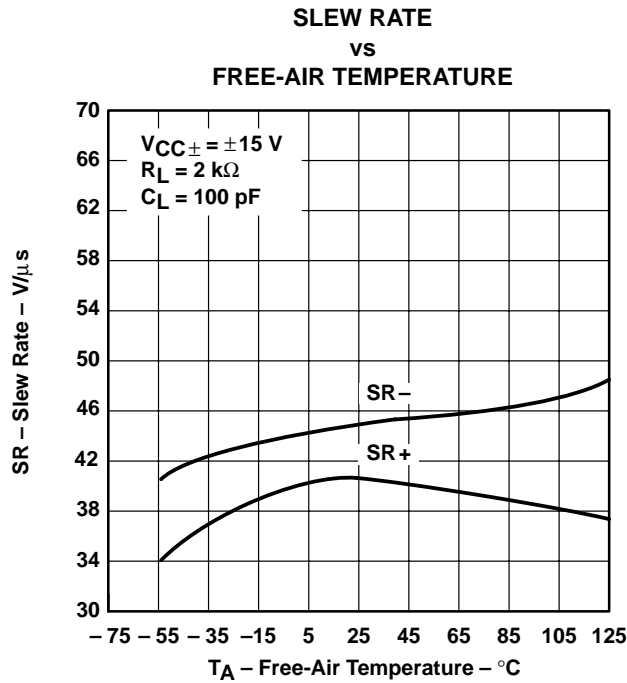

Figure 54

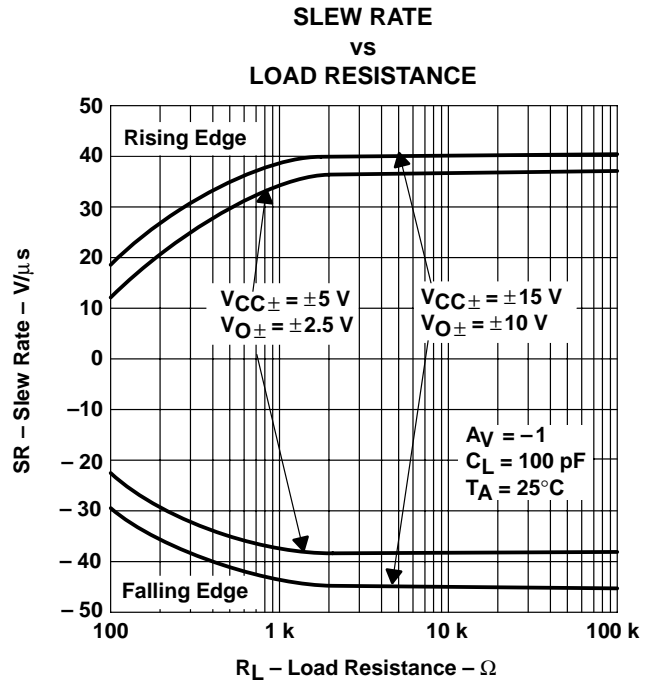

Figure 55

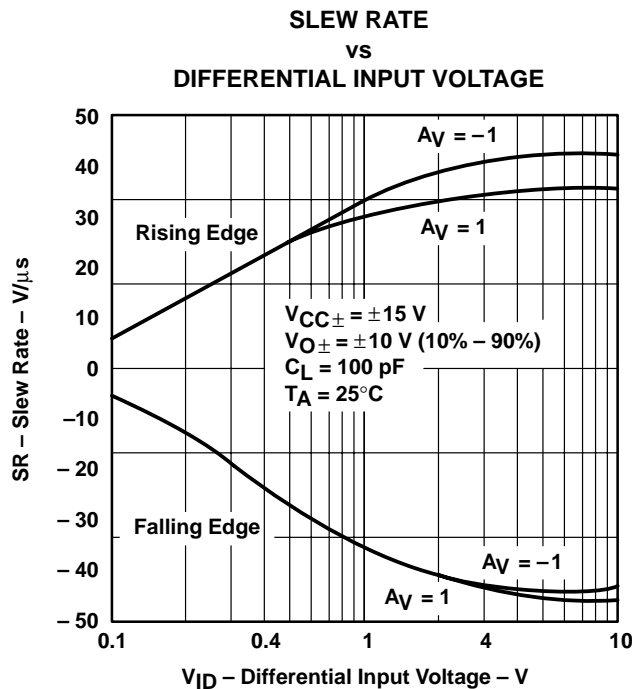

Figure 56

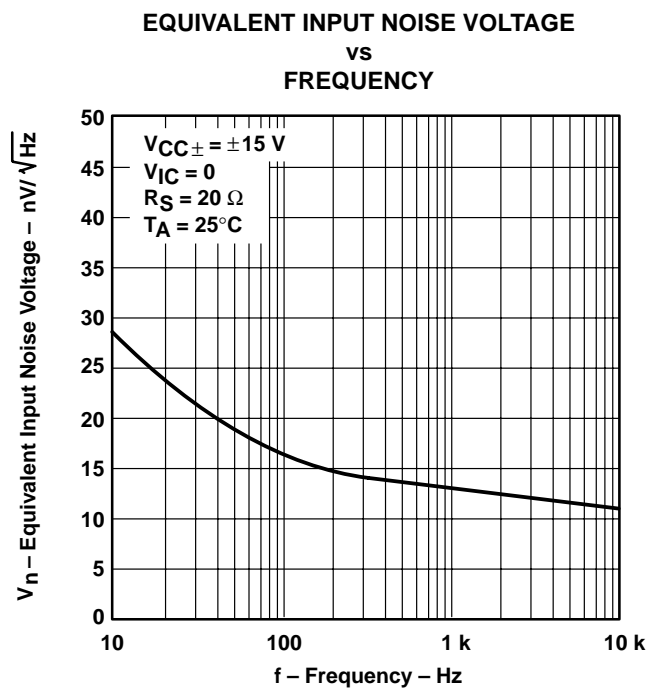

Figure 57

† Data at high and low temperatures are applicable only within the rated operating free-air temperature ranges of the various devices.

TLE208x, TLE208xA, TLE208xY
EXCALIBUR HIGH-SPEED JFET-INPUT
OPERATIONAL AMPLIFIERS

SLOS182B – FEBRUARY 1997 – REVISED JUNE 2001

TYPICAL CHARACTERISTICS

INPUT-REFERRED NOISE VOLTAGE
vs
NOISE BANDWIDTH FREQUENCY

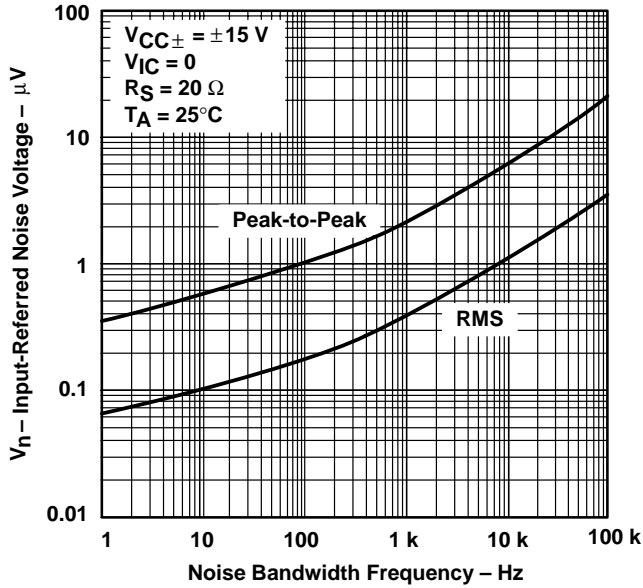

Figure 58

INPUT-REFERRED NOISE VOLTAGE
OVER A 10-SECOND TIME INTERVAL

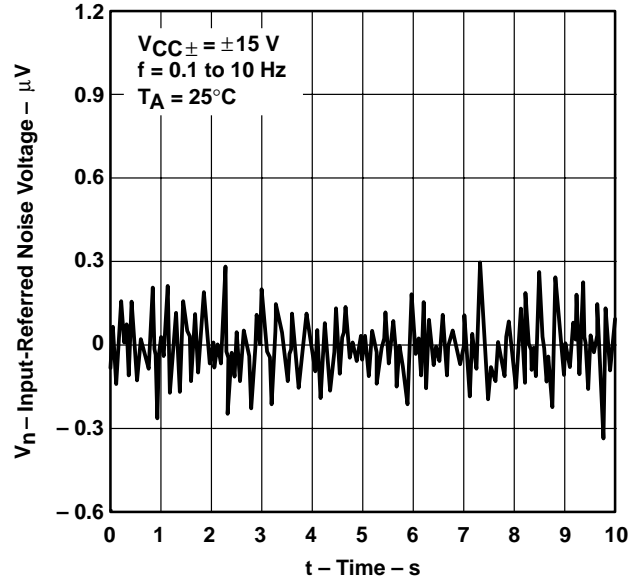

Figure 59

THIRD-OCTAVE SPECTRAL NOISE DENSITY
vs
FREQUENCY BANDS

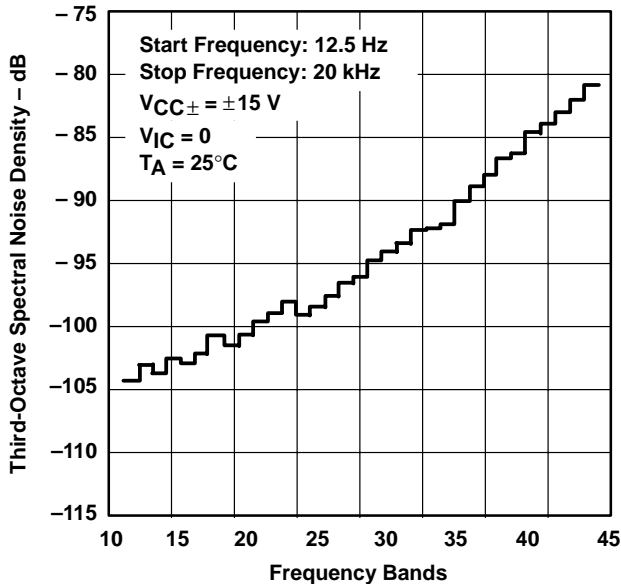

Figure 60

TOTAL HARMONIC DISTORTION PLUS NOISE
vs
FREQUENCY

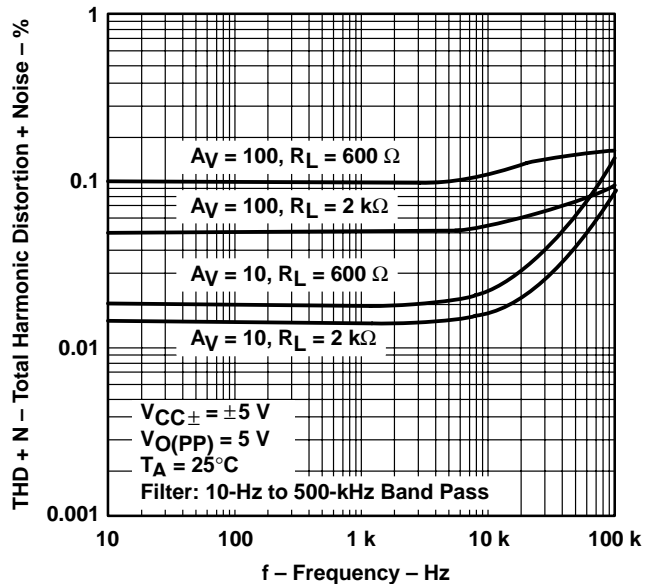

Figure 61



TYPICAL CHARACTERISTICS†

TOTAL HARMONIC DISTORTION PLUS NOISE
vs
FREQUENCY

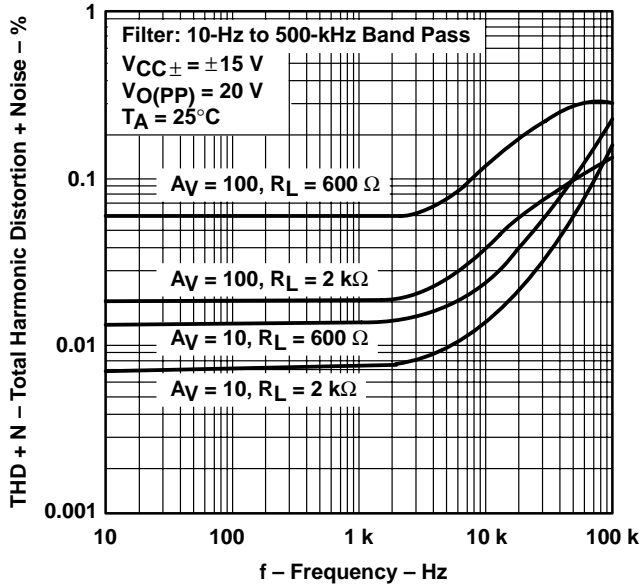

Figure 62

UNITY-GAIN BANDWIDTH
vs
LOAD CAPACITANCE

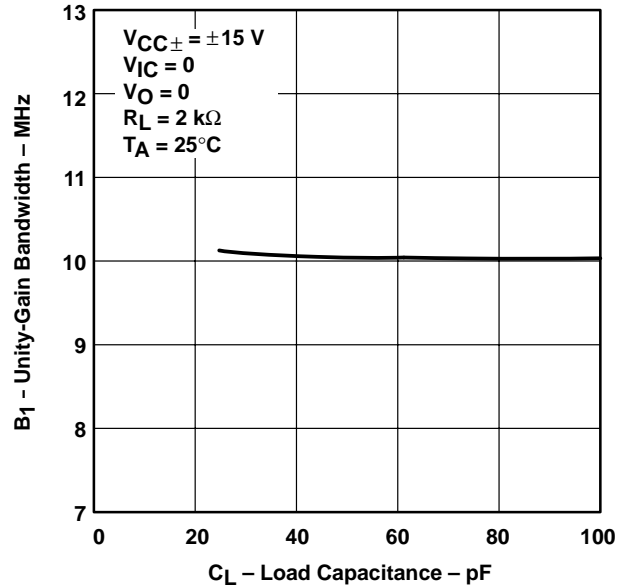

Figure 63

GAIN-BANDWIDTH PRODUCT
vs
FREE-AIR TEMPERATURE

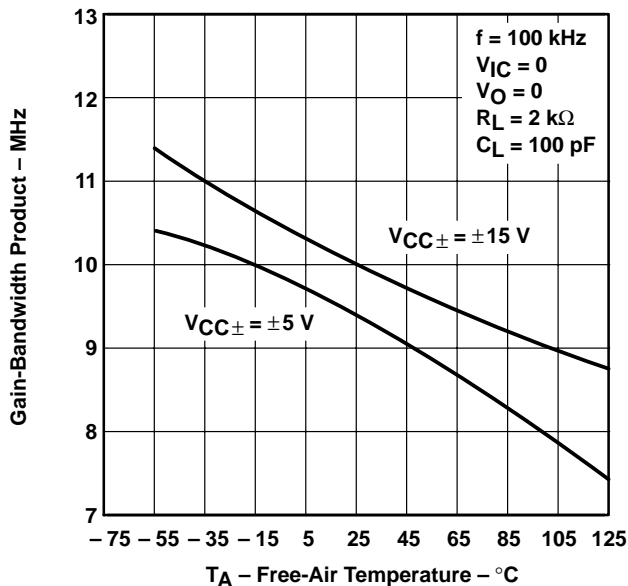

Figure 64

GAIN-BANDWIDTH PRODUCT
vs
SUPPLY VOLTAGE

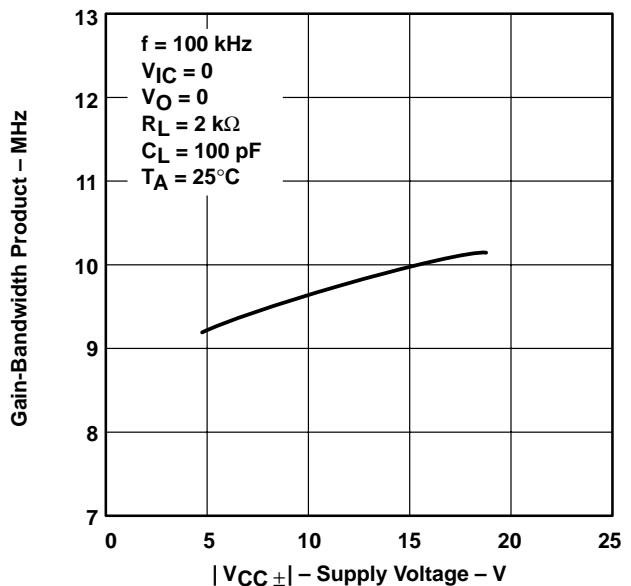

Figure 65

† Data at high and low temperatures are applicable only within the rated operating free-air temperature ranges of the various devices.

TLE208x, TLE208xA, TLE208xY EXCALIBUR HIGH-SPEED JFET-INPUT OPERATIONAL AMPLIFIERS

SLOS182B – FEBRUARY 1997 – REVISED JUNE 2001

TYPICAL CHARACTERISTICS†

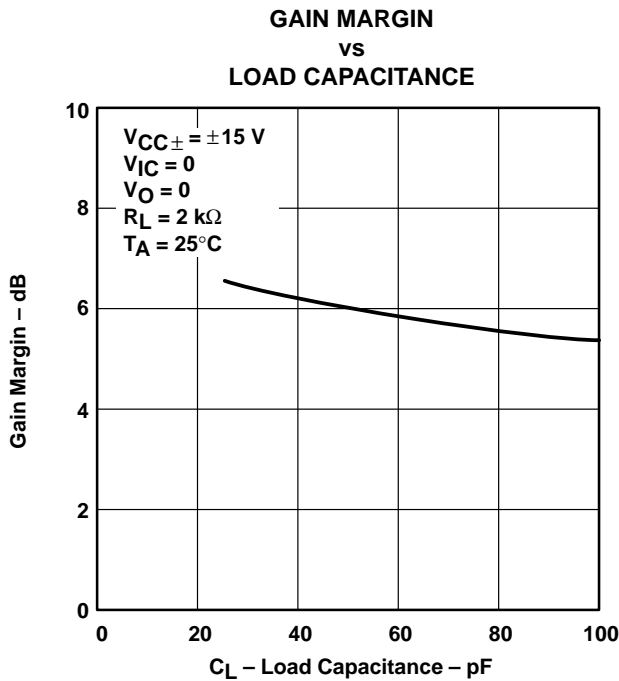

Figure 66

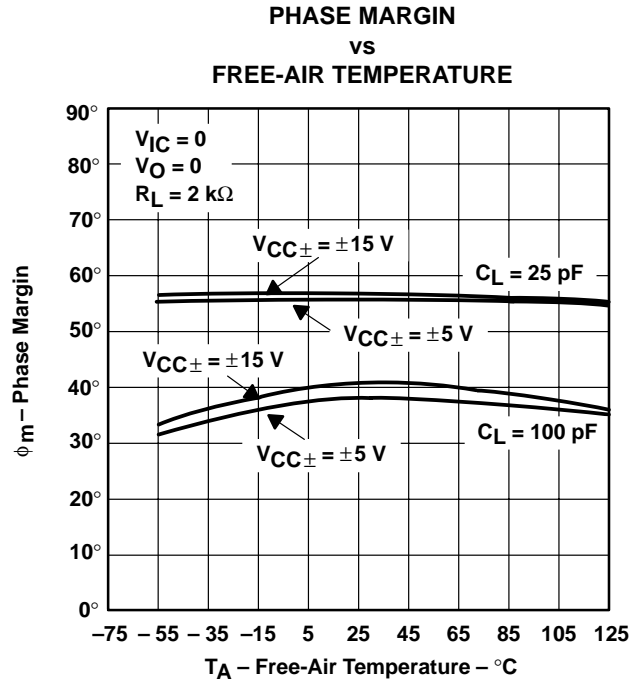

Figure 67

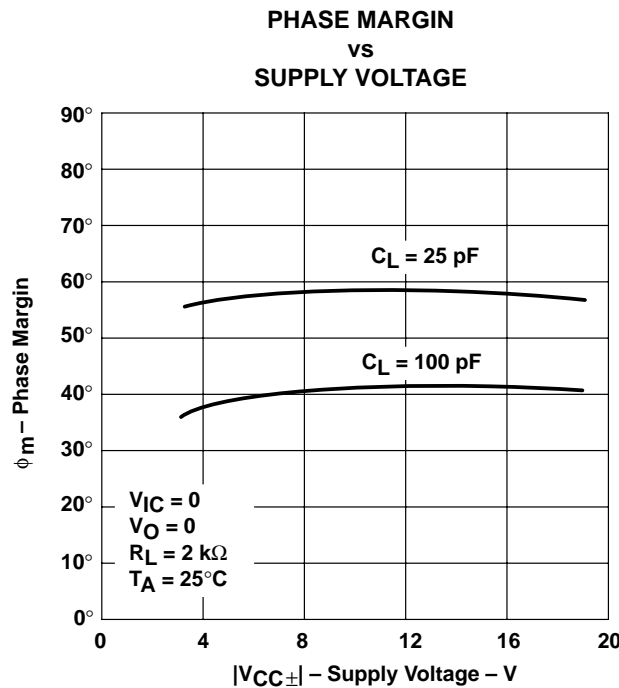

Figure 68

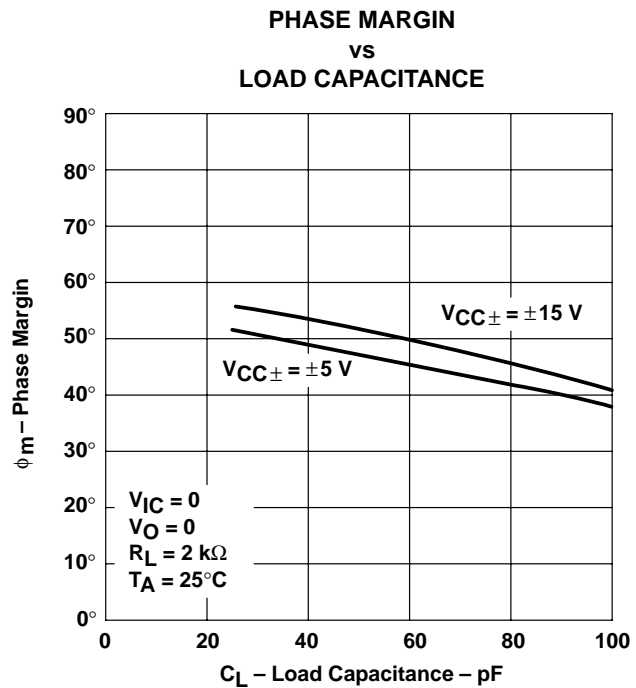

Figure 69

† Data at high and low temperatures are applicable only within the rated operating free-air temperature ranges of the various devices.

TYPICAL CHARACTERISTICS†

NONINVERTING LARGE-SIGNAL
PULSE RESPONSE

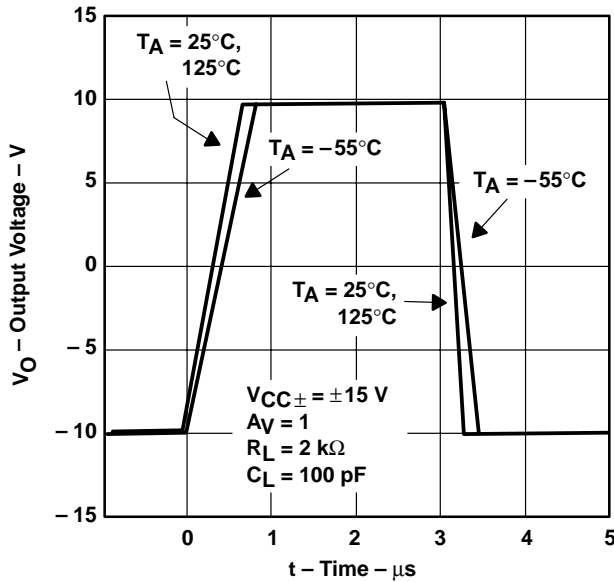

Figure 70

SMALL-SIGNAL PULSE RESPONSE



Figure 71

CLOSED-LOOP OUTPUT IMPEDANCE
vs
FREQUENCY

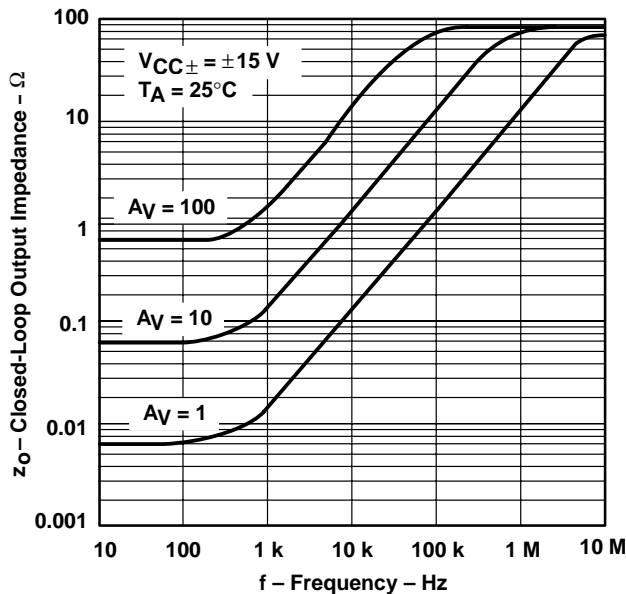

Figure 72

TLE2082 AND TLE2084
CROSSTALK ATTENUATION
vs
FREQUENCY



Figure 73

† Data at high and low temperatures are applicable only within the rated operating free-air temperature ranges of the various devices.

TLE208x, TLE208xA, TLE208xY EXCALIBUR HIGH-SPEED JFET-INPUT OPERATIONAL AMPLIFIERS

SLOS182B – FEBRUARY 1997 – REVISED JUNE 2001

APPLICATION INFORMATION

input characteristics

The TLE208x, TLE208xA, and TLE208xB are specified with a minimum and a maximum input voltage that if exceeded at either input could cause the device to malfunction. Because of the extremely high input impedance and resulting low bias current requirements, the TLE208x, TLE208xA, and TLE208xB are well suited for low-level signal processing; however, leakage currents on printed-circuit boards and sockets can easily exceed bias current requirements and cause degradation in system performance. It is good practice to include guard rings around inputs (see Figure 74). These guards should be driven from a low-impedance source at the same voltage level as the common-mode input.

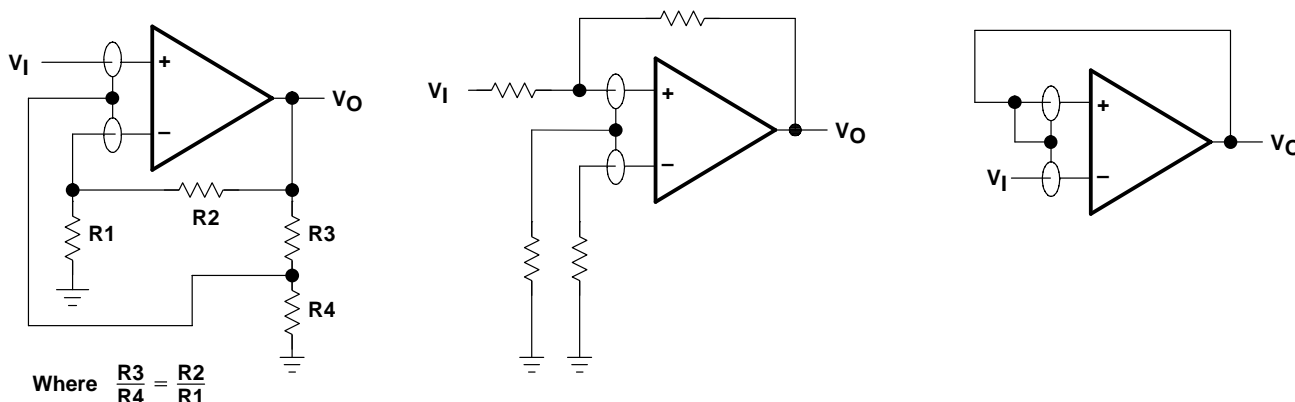

Figure 74. Use of Guard Rings

TLE2081 input offset voltage nulling

The TLE2061 series offers external null pins that can be used to further reduce the input offset voltage. The circuit of Figure 75 can be connected as shown if the feature is desired. When external nulling is not needed, the null pins may be left unconnected.

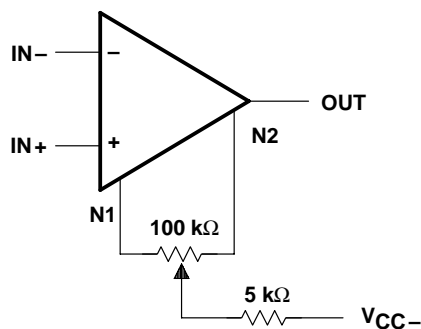

Figure 75. Input Offset Voltage Nulling

APPLICATION INFORMATION

macromodel information

Macromodel information provided was derived using *PSpice™ Parts™* model generation software. The Boyle macromodel (see Note 4) and subcircuit in Figure 58 were generated using the TLE208x typical electrical and operating characteristics at $T_A = 25^\circ\text{C}$. Using this information, output simulations of the following key parameters can be generated to a tolerance of 20% (in most cases):

- Maximum positive output voltage swing
- Maximum negative output voltage swing
- Slew rate
- Quiescent power dissipation
- Input bias current
- Open-loop voltage amplification
- Unity-gain frequency
- Common-mode rejection ratio
- Phase margin
- DC output resistance
- AC output resistance
- Short-circuit output current limit

NOTE 4: G.R. Boyle, B.M. Cohn, D. O. Pederson, and J. E. Solomon, "Macromodeling of Integrated Circuit Operational Amplifiers", *IEEE Journal of Solid-State Circuits*, SC-9, 353 (1974).

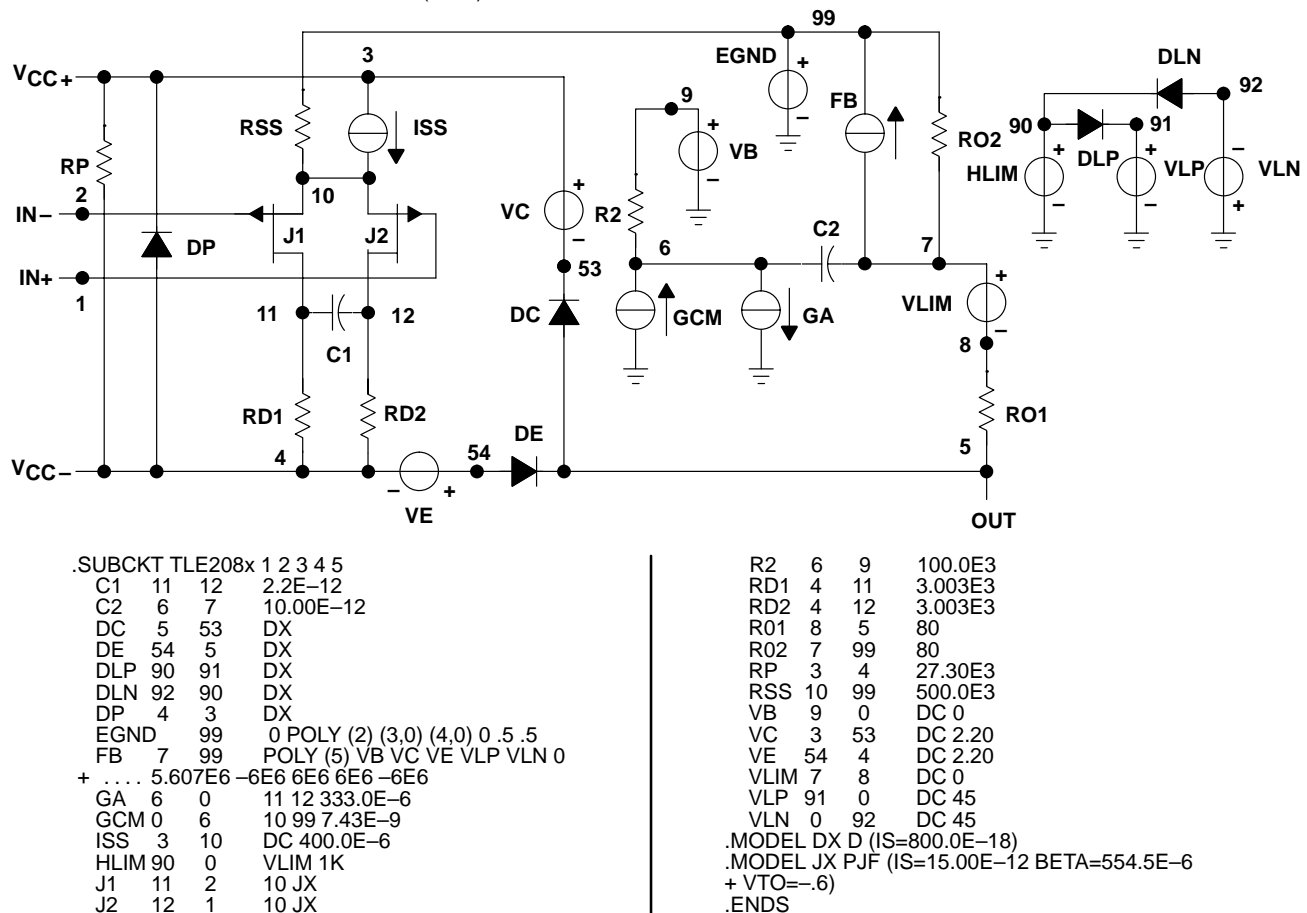

Figure 76. Boyle Macromodel and Subcircuit



PSpice and *Parts* are trademarks of MicroSim Corporation.

PACKAGING INFORMATION

Orderable Device	Status (1)	Package Type	Package Drawing	Pins	Package Qty	Eco Plan (2)	Lead/Ball Finish (6)	MSL Peak Temp (3)	Op Temp (°C)	Device Marking (4/5)	Samples
TLE2081ACD	ACTIVE	SOIC	D	8	75	Green (RoHS & no Sb/Br)	CU NIPDAU	Level-1-260C-UNLIM	0 to 70	2081AC	Samples
TLE2081ACDG4	ACTIVE	SOIC	D	8	75	Green (RoHS & no Sb/Br)	CU NIPDAU	Level-1-260C-UNLIM	0 to 70	2081AC	Samples
TLE2081ACDR	ACTIVE	SOIC	D	8	2500	Green (RoHS & no Sb/Br)	CU NIPDAU	Level-1-260C-UNLIM	0 to 70	2081AC	Samples
TLE2081ACDRG4	ACTIVE	SOIC	D	8	2500	Green (RoHS & no Sb/Br)	CU NIPDAU	Level-1-260C-UNLIM	0 to 70	2081AC	Samples
TLE2081ACP	ACTIVE	PDIP	P	8	50	Pb-Free (RoHS)	CU NIPDAU	N / A for Pkg Type	-40 to 85	TLE2081AC	Samples
TLE2081AID	ACTIVE	SOIC	D	8	75	Green (RoHS & no Sb/Br)	CU NIPDAU	Level-1-260C-UNLIM	-40 to 85	2081AI	Samples
TLE2081AIP	ACTIVE	PDIP	P	8	50	Pb-Free (RoHS)	CU NIPDAU	N / A for Pkg Type	-40 to 85	TLE2081AI	Samples
TLE2081CD	ACTIVE	SOIC	D	8	75	Green (RoHS & no Sb/Br)	CU NIPDAU	Level-1-260C-UNLIM	0 to 70	2081C	Samples
TLE2081CDG4	ACTIVE	SOIC	D	8	75	Green (RoHS & no Sb/Br)	CU NIPDAU	Level-1-260C-UNLIM	0 to 70	2081C	Samples
TLE2081CDR	ACTIVE	SOIC	D	8	2500	Green (RoHS & no Sb/Br)	CU NIPDAU	Level-1-260C-UNLIM	0 to 70	2081C	Samples
TLE2081CP	ACTIVE	PDIP	P	8	50	Pb-Free (RoHS)	CU NIPDAU	N / A for Pkg Type	0 to 70	TLE2081CP	Samples
TLE2081CPE4	ACTIVE	PDIP	P	8	50	Pb-Free (RoHS)	CU NIPDAU	N / A for Pkg Type	0 to 70	TLE2081CP	Samples
TLE2081ID	ACTIVE	SOIC	D	8	75	Green (RoHS & no Sb/Br)	CU NIPDAU	Level-1-260C-UNLIM	-40 to 85	2081I	Samples
TLE2081IDG4	ACTIVE	SOIC	D	8	75	Green (RoHS & no Sb/Br)	CU NIPDAU	Level-1-260C-UNLIM	-40 to 85	2081I	Samples
TLE2081IDR	ACTIVE	SOIC	D	8	2500	Green (RoHS & no Sb/Br)	CU NIPDAU	Level-1-260C-UNLIM		2081I	Samples
TLE2081IP	ACTIVE	PDIP	P	8	50	Pb-Free (RoHS)	CU NIPDAU	N / A for Pkg Type		TLE2081IP	Samples
TLE2082ACD	ACTIVE	SOIC	D	8	75	Green (RoHS & no Sb/Br)	CU NIPDAU	Level-1-260C-UNLIM		2082AC	Samples

Orderable Device	Status (1)	Package Type	Package Drawing	Pins	Package Qty	Eco Plan (2)	Lead/Ball Finish (6)	MSL Peak Temp (3)	Op Temp (°C)	Device Marking (4/5)	Samples
TLE2082ACDG4	ACTIVE	SOIC	D	8	75	Green (RoHS & no Sb/Br)	CU NIPDAU	Level-1-260C-UNLIM		2082AC	Samples
TLE2082ACDR	ACTIVE	SOIC	D	8	2500	Green (RoHS & no Sb/Br)	CU NIPDAU	Level-1-260C-UNLIM		2082AC	Samples
TLE2082ACDRG4	ACTIVE	SOIC	D	8	2500	Green (RoHS & no Sb/Br)	CU NIPDAU	Level-1-260C-UNLIM		2082AC	Samples
TLE2082ACP	ACTIVE	PDIP	P	8	50	Pb-Free (RoHS)	CU NIPDAU	N / A for Pkg Type		TLE2082AC	Samples
TLE2082ACPE4	ACTIVE	PDIP	P	8	50	Pb-Free (RoHS)	CU NIPDAU	N / A for Pkg Type		TLE2082AC	Samples
TLE2082AID	ACTIVE	SOIC	D	8	75	Green (RoHS & no Sb/Br)	CU NIPDAU	Level-1-260C-UNLIM		2082AI	Samples
TLE2082AIDG4	ACTIVE	SOIC	D	8	75	Green (RoHS & no Sb/Br)	CU NIPDAU	Level-1-260C-UNLIM		2082AI	Samples
TLE2082AIDR	ACTIVE	SOIC	D	8	2500	Green (RoHS & no Sb/Br)	CU NIPDAU	Level-1-260C-UNLIM		2082AI	Samples
TLE2082AIDRG4	ACTIVE	SOIC	D	8	2500	Green (RoHS & no Sb/Br)	CU NIPDAU	Level-1-260C-UNLIM		2082AI	Samples
TLE2082AIP	ACTIVE	PDIP	P	8	50	Pb-Free (RoHS)	CU NIPDAU	N / A for Pkg Type		TLE2082AI	Samples
TLE2082AIPE4	ACTIVE	PDIP	P	8	50	Pb-Free (RoHS)	CU NIPDAU	N / A for Pkg Type		TLE2082AI	Samples
TLE2082AMFKB	NRND	LCCC	FK	20	1	TBD	POST-PLATE	N / A for Pkg Type	-55 to 125	TLE2082AMFKB	
TLE2082AMJGB	NRND	CDIP	JG	8	1	TBD	A42	N / A for Pkg Type	-55 to 125	TLE2082AMJGB	
TLE2082AMP	OBSOLETE	PDIP	P	8		TBD	Call TI	Call TI	-55 to 125		
TLE2082CD	ACTIVE	SOIC	D	8	75	Green (RoHS & no Sb/Br)	CU NIPDAU	Level-1-260C-UNLIM		2082C	Samples
TLE2082CDG4	ACTIVE	SOIC	D	8	75	Green (RoHS & no Sb/Br)	CU NIPDAU	Level-1-260C-UNLIM		2082C	Samples
TLE2082CDR	ACTIVE	SOIC	D	8	2500	Green (RoHS & no Sb/Br)	CU NIPDAU	Level-1-260C-UNLIM		2082C	Samples
TLE2082CDRG4	ACTIVE	SOIC	D	8	2500	Green (RoHS & no Sb/Br)	CU NIPDAU	Level-1-260C-UNLIM		2082C	Samples

Orderable Device	Status (1)	Package Type	Package Drawing	Pins	Package Qty	Eco Plan (2)	Lead/Ball Finish (6)	MSL Peak Temp (3)	Op Temp (°C)	Device Marking (4/5)	Samples
TLE2082CP	ACTIVE	PDIP	P	8	50	Pb-Free (RoHS)	CU NIPDAU	N / A for Pkg Type		TLE2082CP	Samples
TLE2082CPE4	ACTIVE	PDIP	P	8	50	Pb-Free (RoHS)	CU NIPDAU	N / A for Pkg Type		TLE2082CP	Samples
TLE2082ID	ACTIVE	SOIC	D	8	75	Green (RoHS & no Sb/Br)	CU NIPDAU	Level-1-260C-UNLIM		2082I	Samples
TLE2082IDG4	ACTIVE	SOIC	D	8	75	Green (RoHS & no Sb/Br)	CU NIPDAU	Level-1-260C-UNLIM		2082I	Samples
TLE2082IDR	ACTIVE	SOIC	D	8	2500	Green (RoHS & no Sb/Br)	CU NIPDAU	Level-1-260C-UNLIM		2082I	Samples
TLE2082IDRG4	ACTIVE	SOIC	D	8	2500	Green (RoHS & no Sb/Br)	CU NIPDAU	Level-1-260C-UNLIM		2082I	Samples
TLE2082IP	ACTIVE	PDIP	P	8	50	Pb-Free (RoHS)	CU NIPDAU	N / A for Pkg Type		TLE2082IP	Samples
TLE2082IPE4	ACTIVE	PDIP	P	8	50	Pb-Free (RoHS)	CU NIPDAU	N / A for Pkg Type		TLE2082IP	Samples
TLE2082MFKB	NRND	LCCC	FK	20	1	TBD	POST-PLATE	N / A for Pkg Type	-55 to 125	TLE2082 MFKB	
TLE2082MJGB	OBSOLETE	CDIP	JG	8		TBD	Call TI	Call TI	-55 to 125		
TLE2082MP	OBSOLETE	PDIP	P	8		TBD	Call TI	Call TI	-55 to 125		
TLE2084ACDW	ACTIVE	SOIC	DW	16	40	Green (RoHS & no Sb/Br)	CU NIPDAU	Level-1-260C-UNLIM		TLE2084AC	Samples
TLE2084ACDWG4	ACTIVE	SOIC	DW	16	40	Green (RoHS & no Sb/Br)	CU NIPDAU	Level-1-260C-UNLIM		TLE2084AC	Samples
TLE2084ACN	ACTIVE	PDIP	N	14	25	Pb-Free (RoHS)	CU NIPDAU	N / A for Pkg Type		TLE2084ACN	Samples
TLE2084CDW	ACTIVE	SOIC	DW	16	40	Green (RoHS & no Sb/Br)	CU NIPDAU	Level-1-260C-UNLIM		TLE2084C	Samples
TLE2084CDWG4	ACTIVE	SOIC	DW	16	40	Green (RoHS & no Sb/Br)	CU NIPDAU	Level-1-260C-UNLIM		TLE2084C	Samples
TLE2084CDWR	ACTIVE	SOIC	DW	16	2000	Green (RoHS & no Sb/Br)	CU NIPDAU	Level-1-260C-UNLIM		TLE2084C	Samples
TLE2084CN	ACTIVE	PDIP	N	14	25	Pb-Free (RoHS)	CU NIPDAU	N / A for Pkg Type		TLE2084CN	Samples
TLE2084CNE4	ACTIVE	PDIP	N	14	25	Pb-Free (RoHS)	CU NIPDAU	N / A for Pkg Type		TLE2084CN	Samples

Orderable Device	Status (1)	Package Type	Package Drawing	Pins	Package Qty	Eco Plan (2)	Lead/Ball Finish (6)	MSL Peak Temp (3)	Op Temp (°C)	Device Marking (4/5)	Samples
TLE2084IDW	ACTIVE	SOIC	DW	16	40	Green (RoHS & no Sb/Br)	CU NIPDAU	Level-1-260C-UNLIM		TLE2084I	
TLE2084IDWG4	ACTIVE	SOIC	DW	16	40	Green (RoHS & no Sb/Br)	CU NIPDAU	Level-1-260C-UNLIM		TLE2084I	
TLE2084IDWR	OBSOLETE	SOIC	DW	16		TBD	Call TI	Call TI			

(1) The marketing status values are defined as follows:

ACTIVE: Product device recommended for new designs.

LIFEBUY: TI has announced that the device will be discontinued, and a lifetime-buy period is in effect.

NRND: Not recommended for new designs. Device is in production to support existing customers, but TI does not recommend using this part in a new design.

PREVIEW: Device has been announced but is not in production. Samples may or may not be available.

OBSOLETE: TI has discontinued the production of the device.

(2) Eco Plan - The planned eco-friendly classification: Pb-Free (RoHS), Pb-Free (RoHS Exempt), or Green (RoHS & no Sb/Br) - please check <http://www.ti.com/productcontent> for the latest availability information and additional product content details.

TBD: The Pb-Free/Green conversion plan has not been defined.

Pb-Free (RoHS): TI's terms "Lead-Free" or "Pb-Free" mean semiconductor products that are compatible with the current RoHS requirements for all 6 substances, including the requirement that lead not exceed 0.1% by weight in homogeneous materials. Where designed to be soldered at high temperatures, TI Pb-Free products are suitable for use in specified lead-free processes.

Pb-Free (RoHS Exempt): This component has a RoHS exemption for either 1) lead-based flip-chip solder bumps used between the die and package, or 2) lead-based die adhesive used between the die and leadframe. The component is otherwise considered Pb-Free (RoHS compatible) as defined above.

Green (RoHS & no Sb/Br): TI defines "Green" to mean Pb-Free (RoHS compatible), and free of Bromine (Br) and Antimony (Sb) based flame retardants (Br or Sb do not exceed 0.1% by weight in homogeneous material)

(3) MSL, Peak Temp. - The Moisture Sensitivity Level rating according to the JEDEC industry standard classifications, and peak solder temperature.

(4) There may be additional marking, which relates to the logo, the lot trace code information, or the environmental category on the device.

(5) Multiple Device Markings will be inside parentheses. Only one Device Marking contained in parentheses and separated by a "~" will appear on a device. If a line is indented then it is a continuation of the previous line and the two combined represent the entire Device Marking for that device.

(6) Lead/Ball Finish - Orderable Devices may have multiple material finish options. Finish options are separated by a vertical ruled line. Lead/Ball Finish values may wrap to two lines if the finish value exceeds the maximum column width.

Important Information and Disclaimer: The information provided on this page represents TI's knowledge and belief as of the date that it is provided. TI bases its knowledge and belief on information provided by third parties, and makes no representation or warranty as to the accuracy of such information. Efforts are underway to better integrate information from third parties. TI has taken and continues to take reasonable steps to provide representative and accurate information but may not have conducted destructive testing or chemical analysis on incoming materials and chemicals. TI and TI suppliers consider certain information to be proprietary, and thus CAS numbers and other limited information may not be available for release.

In no event shall TI's liability arising out of such information exceed the total purchase price of the TI part(s) at issue in this document sold by TI to Customer on an annual basis.

OTHER QUALIFIED VERSIONS OF TLE2082, TLE2082A, TLE2082AM, TLE2082M :

- Catalog: [TLE2082A](#), [TLE2082](#)
- Military: [TLE2082M](#), [TLE2082AM](#)

NOTE: Qualified Version Definitions:

- Catalog - TI's standard catalog product
- Military - QML certified for Military and Defense Applications

TAPE AND REEL INFORMATION
REEL DIMENSIONS

TAPE DIMENSIONS

A0	Dimension designed to accommodate the component width
B0	Dimension designed to accommodate the component length
K0	Dimension designed to accommodate the component thickness
W	Overall width of the carrier tape
P1	Pitch between successive cavity centers

TAPE AND REEL INFORMATION

*All dimensions are nominal

Device	Package Type	Package Drawing	Pins	SPQ	Reel Diameter (mm)	Reel Width W1 (mm)	A0 (mm)	B0 (mm)	K0 (mm)	P1 (mm)	W (mm)	Pin1 Quadrant
TLE2081ACDR	SOIC	D	8	2500	330.0	12.4	6.4	5.2	2.1	8.0	12.0	Q1
TLE2081CDR	SOIC	D	8	2500	330.0	12.4	6.4	5.2	2.1	8.0	12.0	Q1
TLE2081IDR	SOIC	D	8	2500	330.0	12.4	6.4	5.2	2.1	8.0	12.0	Q1
TLE2081IDR	SOIC	D	8	2500	330.0	12.4	6.4	5.2	2.1	8.0	12.0	Q1
TLE2082ACDR	SOIC	D	8	2500	330.0	12.4	6.4	5.2	2.1	8.0	12.0	Q1
TLE2082AIDR	SOIC	D	8	2500	330.0	12.4	6.4	5.2	2.1	8.0	12.0	Q1
TLE2082AIDR	SOIC	D	8	2500	330.0	12.4	6.4	5.2	2.1	8.0	12.0	Q1
TLE2082CDR	SOIC	D	8	2500	330.0	12.4	6.4	5.2	2.1	8.0	12.0	Q1
TLE2082IDR	SOIC	D	8	2500	330.0	12.4	6.4	5.2	2.1	8.0	12.0	Q1
TLE2084CDWR	SOIC	DW	16	2000	330.0	16.4	10.75	10.7	2.7	12.0	16.0	Q1

TAPE AND REEL BOX DIMENSIONS

*All dimensions are nominal

Device	Package Type	Package Drawing	Pins	SPQ	Length (mm)	Width (mm)	Height (mm)
TLE2081ACDR	SOIC	D	8	2500	340.5	338.1	20.6
TLE2081CDR	SOIC	D	8	2500	340.5	338.1	20.6
TLE2081IDR	SOIC	D	8	2500	340.5	338.1	20.6
TLE2081IDR	SOIC	D	8	2500	367.0	367.0	35.0
TLE2082ACDR	SOIC	D	8	2500	340.5	338.1	20.6
TLE2082AIDR	SOIC	D	8	2500	367.0	367.0	35.0
TLE2082AIDR	SOIC	D	8	2500	340.5	338.1	20.6
TLE2082CDR	SOIC	D	8	2500	340.5	338.1	20.6
TLE2082IDR	SOIC	D	8	2500	340.5	338.1	20.6
TLE2084CDWR	SOIC	DW	16	2000	367.0	367.0	38.0

JG (R-GDIP-T8)

CERAMIC DUAL-IN-LINE



- NOTES: A. All linear dimensions are in inches (millimeters).
 B. This drawing is subject to change without notice.
 C. This package can be hermetically sealed with a ceramic lid using glass frit.
 D. Index point is provided on cap for terminal identification.
 E. Falls within MIL STD 1835 GDIP1-T8

FK (S-CQCC-N**)

LEADLESS CERAMIC CHIP CARRIER

28 TERMINAL SHOWN



NO. OF TERMINALS **	A		B	
	MIN	MAX	MIN	MAX
20	0.342 (8,69)	0.358 (9,09)	0.307 (7,80)	0.358 (9,09)
28	0.442 (11,23)	0.458 (11,63)	0.406 (10,31)	0.458 (11,63)
44	0.640 (16,26)	0.660 (16,76)	0.495 (12,58)	0.560 (14,22)
52	0.740 (18,78)	0.761 (19,32)	0.495 (12,58)	0.560 (14,22)
68	0.938 (23,83)	0.962 (24,43)	0.850 (21,6)	0.858 (21,8)
84	1.141 (28,99)	1.165 (29,59)	1.047 (26,6)	1.063 (27,0)

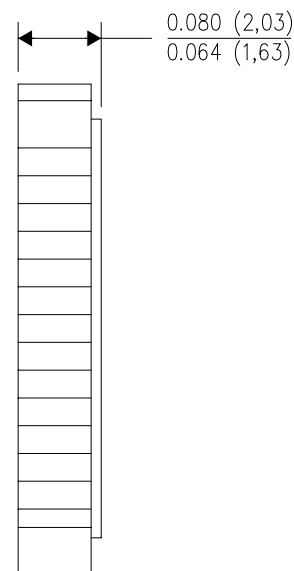
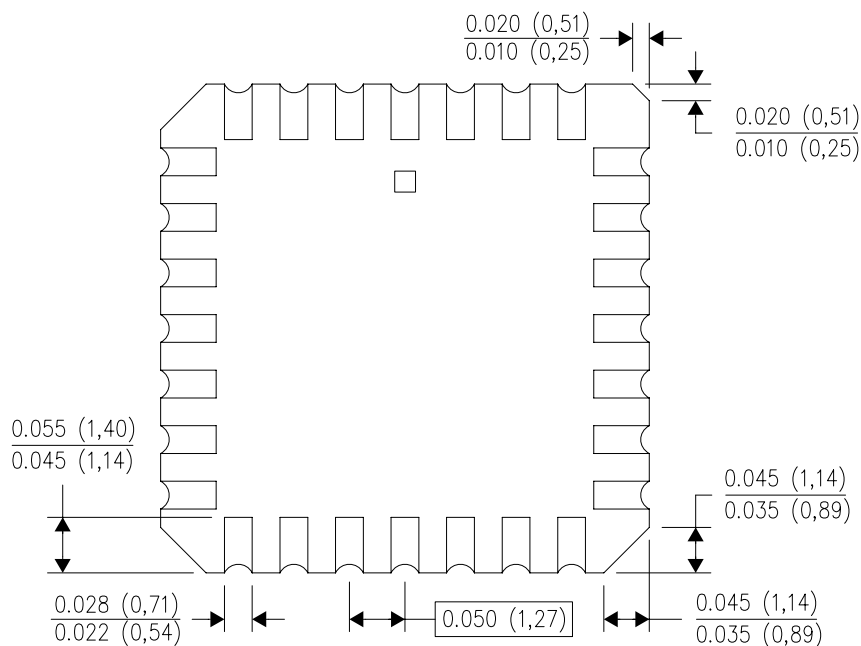

4040140/D 01/11

- NOTES:
- A. All linear dimensions are in inches (millimeters).
 - B. This drawing is subject to change without notice.
 - C. This package can be hermetically sealed with a metal lid.
 - D. Falls within JEDEC MS-004

P (R-PDIP-T8)

PLASTIC DUAL-IN-LINE PACKAGE



- NOTES:
- A. All linear dimensions are in inches (millimeters).
 - B. This drawing is subject to change without notice.
 - C. Falls within JEDEC MS-001 variation BA.

D (R-PDSO-G8)

PLASTIC SMALL OUTLINE

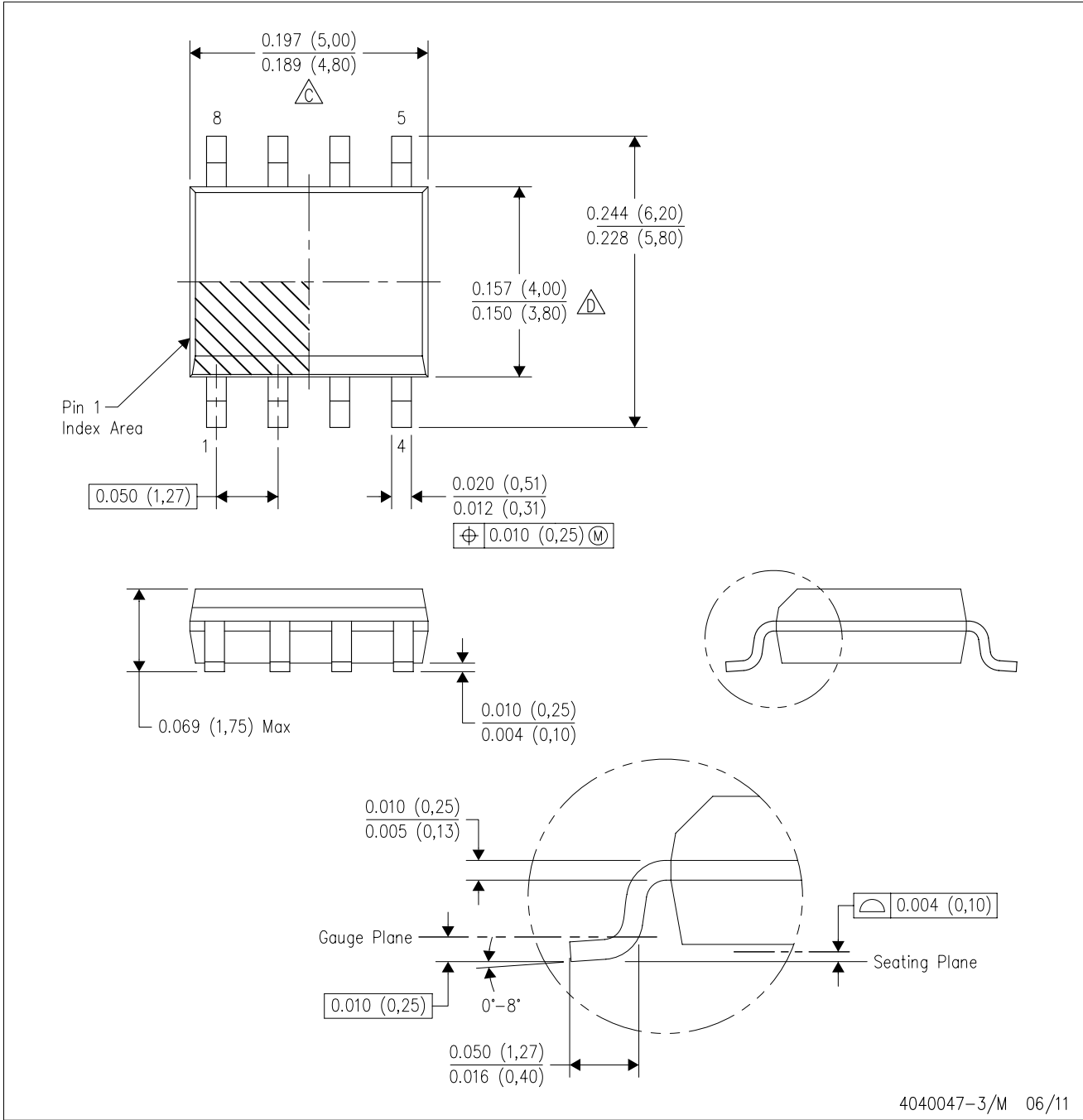

4040047-3/M 06/11

- NOTES:
- A. All linear dimensions are in inches (millimeters).
 - B. This drawing is subject to change without notice.
 - $\triangle C$ Body length does not include mold flash, protrusions, or gate burrs. Mold flash, protrusions, or gate burrs shall not exceed 0.006 (0,15) each side.
 - $\triangle D$ Body width does not include interlead flash. Interlead flash shall not exceed 0.017 (0,43) each side.
 - E. Reference JEDEC MS-012 variation AA.

D (R-PDSO-G8)

PLASTIC SMALL OUTLINE



4211283-2/E 08/12

- NOTES:
- A. All linear dimensions are in millimeters.
 - B. This drawing is subject to change without notice.
 - C. Publication IPC-7351 is recommended for alternate designs.
 - D. Laser cutting apertures with trapezoidal walls and also rounding corners will offer better paste release. Customers should contact their board assembly site for stencil design recommendations. Refer to IPC-7525 for other stencil recommendations.
 - E. Customers should contact their board fabrication site for solder mask tolerances between and around signal pads.

DW (R-PDSO-G16)

PLASTIC SMALL OUTLINE



- NOTES:
- All linear dimensions are in inches (millimeters). Dimensioning and tolerancing per ASME Y14.5M-1994.
 - This drawing is subject to change without notice.
 - Body dimensions do not include mold flash or protrusion not to exceed 0.006 (0,15).
 - Falls within JEDEC MS-013 variation AA.

IMPORTANT NOTICE

Texas Instruments Incorporated and its subsidiaries (TI) reserve the right to make corrections, enhancements, improvements and other changes to its semiconductor products and services per JESD46, latest issue, and to discontinue any product or service per JESD48, latest issue. Buyers should obtain the latest relevant information before placing orders and should verify that such information is current and complete. All semiconductor products (also referred to herein as "components") are sold subject to TI's terms and conditions of sale supplied at the time of order acknowledgment.

TI warrants performance of its components to the specifications applicable at the time of sale, in accordance with the warranty in TI's terms and conditions of sale of semiconductor products. Testing and other quality control techniques are used to the extent TI deems necessary to support this warranty. Except where mandated by applicable law, testing of all parameters of each component is not necessarily performed.

TI assumes no liability for applications assistance or the design of Buyers' products. Buyers are responsible for their products and applications using TI components. To minimize the risks associated with Buyers' products and applications, Buyers should provide adequate design and operating safeguards.

TI does not warrant or represent that any license, either express or implied, is granted under any patent right, copyright, mask work right, or other intellectual property right relating to any combination, machine, or process in which TI components or services are used. Information published by TI regarding third-party products or services does not constitute a license to use such products or services or a warranty or endorsement thereof. Use of such information may require a license from a third party under the patents or other intellectual property of the third party, or a license from TI under the patents or other intellectual property of TI.

Reproduction of significant portions of TI information in TI data books or data sheets is permissible only if reproduction is without alteration and is accompanied by all associated warranties, conditions, limitations, and notices. TI is not responsible or liable for such altered documentation. Information of third parties may be subject to additional restrictions.

Resale of TI components or services with statements different from or beyond the parameters stated by TI for that component or service voids all express and any implied warranties for the associated TI component or service and is an unfair and deceptive business practice. TI is not responsible or liable for any such statements.

Buyer acknowledges and agrees that it is solely responsible for compliance with all legal, regulatory and safety-related requirements concerning its products, and any use of TI components in its applications, notwithstanding any applications-related information or support that may be provided by TI. Buyer represents and agrees that it has all the necessary expertise to create and implement safeguards which anticipate dangerous consequences of failures, monitor failures and their consequences, lessen the likelihood of failures that might cause harm and take appropriate remedial actions. Buyer will fully indemnify TI and its representatives against any damages arising out of the use of any TI components in safety-critical applications.

In some cases, TI components may be promoted specifically to facilitate safety-related applications. With such components, TI's goal is to help enable customers to design and create their own end-product solutions that meet applicable functional safety standards and requirements. Nonetheless, such components are subject to these terms.

No TI components are authorized for use in FDA Class III (or similar life-critical medical equipment) unless authorized officers of the parties have executed a special agreement specifically governing such use.

Only those TI components which TI has specifically designated as military grade or "enhanced plastic" are designed and intended for use in military/aerospace applications or environments. Buyer acknowledges and agrees that any military or aerospace use of TI components which have **not** been so designated is solely at the Buyer's risk, and that Buyer is solely responsible for compliance with all legal and regulatory requirements in connection with such use.

TI has specifically designated certain components as meeting ISO/TS16949 requirements, mainly for automotive use. In any case of use of non-designated products, TI will not be responsible for any failure to meet ISO/TS16949.

Products

Audio	www.ti.com/audio
Amplifiers	amplifier.ti.com
Data Converters	dataconverter.ti.com
DLP® Products	www.dlp.com
DSP	dsp.ti.com
Clocks and Timers	www.ti.com/clocks
Interface	interface.ti.com
Logic	logic.ti.com
Power Mgmt	power.ti.com
Microcontrollers	microcontroller.ti.com
RFID	www.ti-rfid.com
OMAP Applications Processors	www.ti.com/omap
Wireless Connectivity	www.ti.com/wirelessconnectivity

Applications

Automotive and Transportation	www.ti.com/automotive
Communications and Telecom	www.ti.com/communications
Computers and Peripherals	www.ti.com/computers
Consumer Electronics	www.ti.com/consumer-apps
Energy and Lighting	www.ti.com/energy
Industrial	www.ti.com/industrial
Medical	www.ti.com/medical
Security	www.ti.com/security
Space, Avionics and Defense	www.ti.com/space-avionics-defense
Video and Imaging	www.ti.com/video

TI E2E Community

e2e.ti.com