



OCTAL BIDIRECTIONAL TRANSCEIVER WITH 8-BIT PARITY GENERATOR CHECKER (3-STATE OUTPUTS)

The MC74F657A and MC74F657B are Octal Bidirectional Transceivers with an 8-bit parity Generator/Checker and 3-state outputs.

The A and B options are faster versions of the F657 and contain eight non-inverting buffers with 3-state outputs and an 8-bit parity generator/checker. These devices are intended for bus-oriented applications. The buffers have a guaranteed current sinking capability of 24 mA at the A ports and 64 mA at the B ports. The Transmit/Receiver (T/R) input determines the direction of the data flow through the bidirectional transceivers. Transmit (active HIGH) enables data from A ports to B ports; Receive (active LOW) enables data from B ports to A ports.

- High-Impedance NPN Base Input for Reduced Loading (20 μ A in HIGH and LOW States)
- Ideal in Applications Where High Output Drive and Light Bus Loading are Required (I_{OL} is 20 μ A versus Fast std of 600 μ A)
- Combines F245 and F280A Functions in One Package
- 3-State Outputs
- B Outputs, PARITY, ERROR, Sink 64 mA and Source 15 mA
- 15 mA Source Current
- Input Diodes for Termination Effects
- Glitchless Outputs During Power Up and Power Down
- High Impedance Outputs During Power Off
- ESD Protection > 4000 Volts

PIN ASSIGNMENT

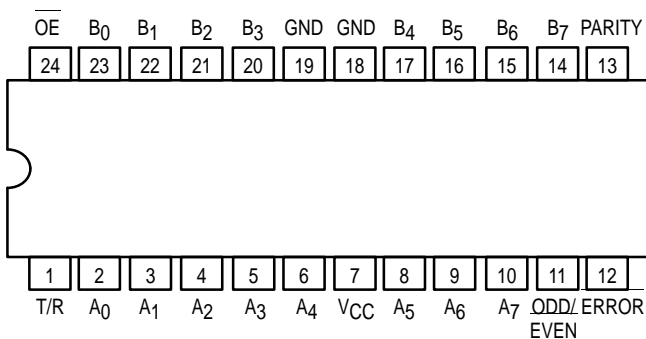

LOGIC SYMBOL

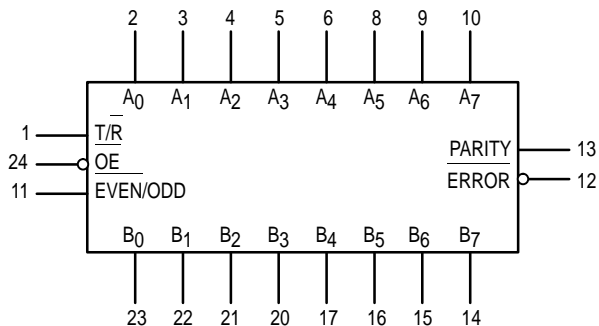

MC74F657A,B

OCTAL BIDIRECTIONAL TRANSCEIVER WITH 8-BIT PARITY GENERATOR CHECKER (3-STATE OUTPUTS)

FAST™ SCHOTTKY TTL

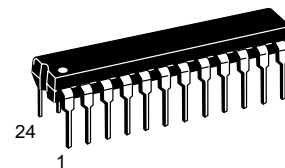

J SUFFIX
CERAMIC
CASE 758-01

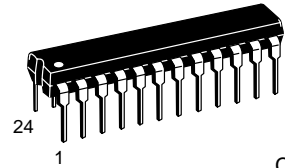

N SUFFIX
PLASTIC
CASE 724-03

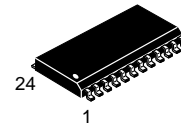

DW SUFFIX
SOIC
CASE 751E-03

ORDERING INFORMATION

MC74FXXXAJ/BJ	Ceramic
MC74FXXXAN/BN	Plastic
MC74FXXXADW/BDW	SOIC

LIFETIME BUY

LAST SHIP 30/09/99
LAST ORDER 31/03/99

MC74F657A, B

GUARANTEED OPERATING RANGES

Symbol	Parameter	Min	Typ	Max	Unit
V _{CC}	Supply Voltage	74	4.5	5.5	V
T _A	Operating Ambient Temperature Range	74	0	70	°C
I _{OH}	Output Current — High	74		-3.0/-15	mA
I _{OL}	Output Current — Low	74		24/64	mA

FUNCTION TABLE

Number of Inputs That are High	Inputs			Input/Output	Outputs	
	OE	T/R	Even/Odd	Parity	Error	Outputs Mode
0, 2, 4, 6, 8	L	H	H	H	Z	Transmit
	L	H	L	L	Z	Transmit
	L	L	H	H	H	Receive
	L	L	H	L	L	Receive
	L	L	L	H	L	Receive
	L	L	L	L	H	Receive

Number of Inputs That are High	Inputs			Input/Output	Outputs	
	OE	T/R	Even/Odd	Parity	Error	Outputs Mode
1, 3, 5, 7	L	H	H	L	Z	Transmit
	L	H	L	H	Z	Transmit
	L	L	H	H	L	Receive
	L	L	H	L	H	Receive
	L	L	L	H	H	Receive
	L	L	L	L	L	Receive
Don't Care	H	X	X	Z	Z	Z

H = HIGH Voltage Level; L = LOW Voltage Level; X = Don't Care; Z = HIGH impedance state.

LIFETIME BUY

LAST SHIP 30/09/99 LAST ORDER 31/03/99

MC74F657A, B

DC CHARACTERISTICS OVER OPERATING TEMPERATURE RANGE (unless otherwise specified)

Symbol	Parameter		Limits			Unit	Test Conditions		
			Min	Typ	Max				
V _{IH}	Input HIGH Voltage		2.0			V	Guaranteed Input HIGH Voltage		
V _{IL}	Input LOW Voltage				0.8	V	Guaranteed Input LOW Voltage		
V _{IK}	Input Clamp Diode Voltage			-0.73	-1.2	V	V _{CC} = MIN, I _{IN} = -18 mA		
V _{OH}	Output HIGH Voltage	All Outputs	74	2.4		V	I _{OH} = -3.0 mA	V _{CC} = 4.5 V	
				2.7	3.4			V _{CC} = 4.75 V	
		B0-B7 PARITY, ERROR	74	2.0		V	I _{OH} = -15 mA	V _{CC} = 4.5 V	
V _{OL}	Output LOW Voltage	A0-A7	74		0.35	0.5	V	I _{OL} = 24 mA	V _{CC} = MIN
		B0-B7 PARITY, ERROR	74		0.4	0.55	V	I _{OL} = 64 mA	
I _{IH}	Input HIGH Current	T/R, OE, EVEN/ODD				100	μA	V _{CC} = 0 V, V _{IN} = 7.0 V	
		A0-A7				2.0	mA	V _{CC} = 5.5 V, V _{IN} = 5.5 V	
		B0-B7, PARITY				1.0	mA	V _{CC} = 5.5 V, V _{IN} = 5.5 V	
		EVEN/ODD				20	μA	V _{CC} = MAX, V _{IN} = 2.7 V	
		T/R, OE				40	μA		
I _{IL}	Input LOW Current	EVEN/ODD				-20	μA	V _{CC} = MAX, V _{IN} = 0.5 V	
		T/R, OE				-40	μA		
I _{IH} +I _{OZH}	Off-State Current HIGH Level Voltage Applied	A0-A7 B0-B7 PARITY				70	μA	V _{CC} = MAX, V _{OUT} = 2.7 V	
I _{IL} +I _{OZL}	Off-State Current LOW Level Voltage Applied					-70	μA	V _{CC} = MAX, V _{OUT} = 0.5 V	
I _{OZH}	Off-State Output Current, High-Level Voltage Applied	ERROR				50	μA	V _{CC} = MAX, V _{OUT} = 2.7 V	
I _{OZL}	Off-State Output Current, Low-Level Voltage Applied					-50	μA	V _{CC} = MAX, V _{OUT} = 0.5 V	
I _{OS}	Output Short Circuit Current (Note 2)	A _n Outputs		-60		-150	mA	V _{CC} = MAX, V _{OUT} = 0 V	
		PARITY, B _n Outputs, ERROR		-100		-225			
I _{CC}	Total Supply Current	I _{CCH}			90	135	mA	V _{CC} = MAX	
		I _{CCL}			106	150			
		I _{CCZ}			98	145			

NOTES:

1. For conditions shown as MIN or MAX, use appropriate value specified under recommended operating conditions for the applicable device type.
2. Not more than one output should be shorted at one time, nor for more than 1 second.

LIFETIME BUY

LAST SHIP 30/09/99 LAST ORDER 31/03/99

MC74F657A, B

F657A

AC ELECTRICAL CHARACTERISTICS

Symbol	Parameter	74F			74F		Unit
		T _A = +25°C V _{CC} = +5.0 V C _L = 50 pF			T _A = 0°C to +70°C V _{CC} = +5.0 V ± 10% C _L = 50 pF		
		Min	Typ	Max	Min	Max	
t _{PLH} t _{PHL}	Propagation Delay A _n to B _n or B _n to A _n	2.0		7.0	2.0	7.5	ns
t _{PLH} t _{PHL}	Propagation Delay A _n to PARITY	6.0		13	5.5	14	ns
t _{PLH} t _{PHL}	Propagation Delay EVEN / ODD to PARITY, ERROR	4.5		10.5	4.5	11	ns
t _{PLH} t _{PHL}	Propagation Delay B _n to ERROR	7.0		18	6.5	19	ns
t _{PLH} t _{PHL}	Propagation Delay PARITY to ERROR	8.0		14	7.0	15	ns
t _{PZH} t _{PZL}	Output Enable Time to HIGH or LOW Level	3.0		8.0	3.0	9.0	ns
t _{PHZ} t _{PLZ}	Output Disable Time from HIGH or LOW Level	2.0		7.5	2.0	8.0	ns

F657B

AC ELECTRICAL CHARACTERISTICS

Symbol	Parameter	74F			74F		Unit
		T _A = +25°C V _{CC} = +5.0 V C _L = 50 pF			T _A = 0°C to +70°C V _{CC} = +5.0 V ± 10% C _L = 50 pF		
		Min	Typ	Max	Min	Max	
t _{PLH} t _{PHL}	Propagation Delay A _n to B _n or B _n to A _n	2.0		6.0	2.0	6.5	ns
t _{PLH} t _{PHL}	Propagation Delay A _n to PARITY	4.5		11.5	4.5	13	ns
t _{PLH} t _{PHL}	Propagation Delay EVEN/ODD to PARITY, ERROR	2.0		7.5	2.0	8.5	ns
t _{PLH} t _{PHL}	Propagation Delay B _n to ERROR	4.0		15	3.5	16	ns
t _{PLH} t _{PHL}	Propagation Delay PARITY to ERROR	5.0		11	4.0	12	ns
t _{PZH} t _{PZL}	Output Enable Time to HIGH or LOW Level	2.0		7.0	2.0	8.0	ns
t _{PHZ} t _{PLZ}	Output Disable Time from HIGH or LOW Level	2.0		6.0	2.0	6.5	ns

LIFETIME BUY

LAST SHIP 30/09/99

LAST ORDER 31/03/99

MC74F657A, B

LOGIC DIAGRAM

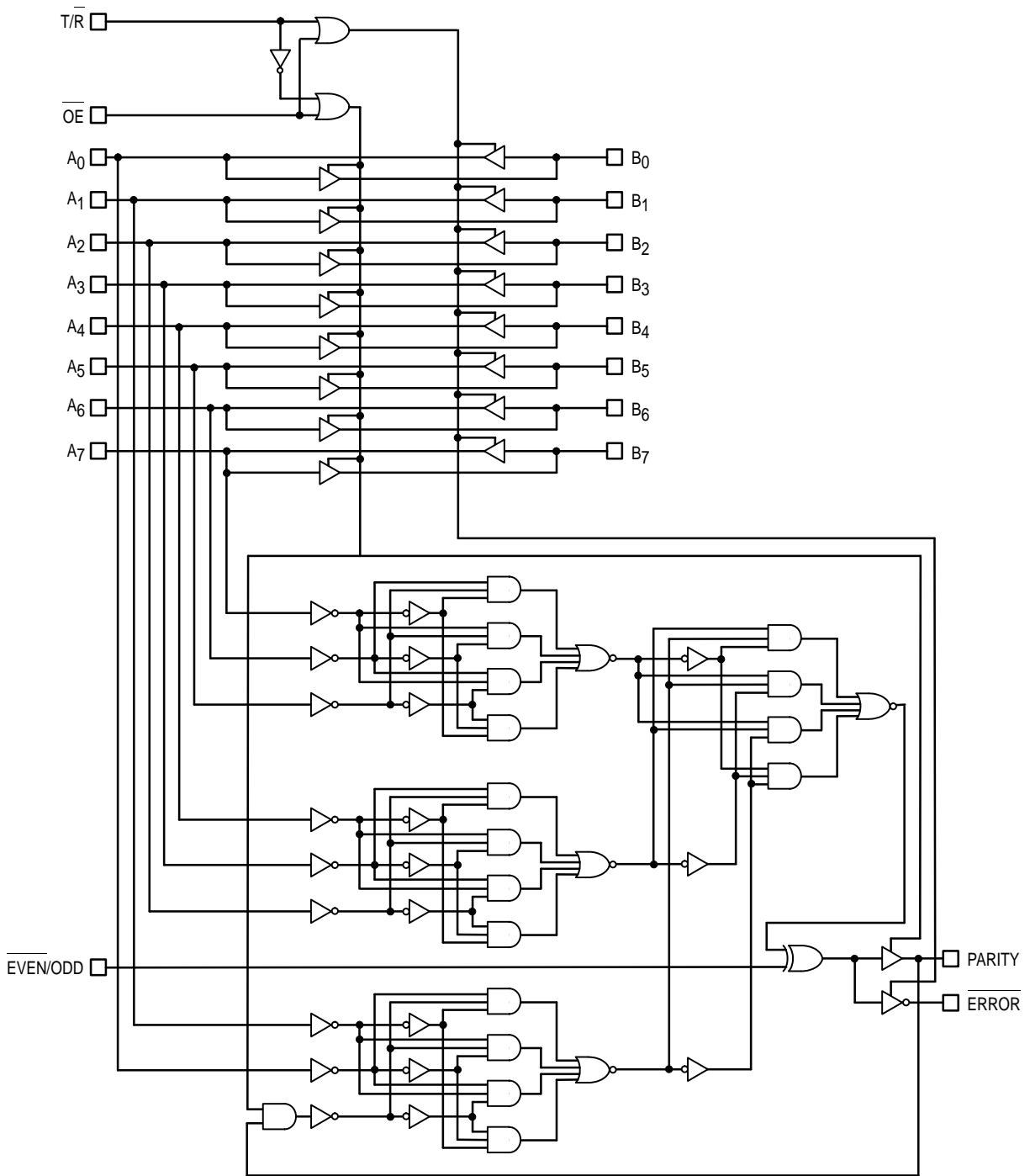

LIFETIME BUY

LAST ORDER 31/03/99 LAST SHIP 30/09/99

LIFETIME BUY

LAST ORDER 31/03/99 LAST SHIP 30/09/99

Mfax is a trademark of Motorola, Inc.

Motorola reserves the right to make changes without further notice to any products herein. Motorola makes no warranty, representation or guarantee regarding the suitability of its products for any particular purpose, nor does Motorola assume any liability arising out of the application or use of any product or circuit, and specifically disclaims any and all liability, including without limitation consequential or incidental damages. "Typical" parameters which may be provided in Motorola data sheets and/or specifications can and do vary in different applications and actual performance may vary over time. All operating parameters, including "Typicals" must be validated for each customer application by customer's technical experts. Motorola does not convey any license under its patent rights nor the rights of others. Motorola products are not designed, intended, or authorized for use as components in systems intended for surgical implant into the body, or other applications intended to support or sustain life, or for any other application in which the failure of the Motorola product could create a situation where personal injury or death may occur. Should Buyer purchase or use Motorola products for any such unintended or unauthorized application, Buyer shall indemnify and hold Motorola and its officers, employees, subsidiaries, affiliates, and distributors harmless against all claims, costs, damages, and expenses, and reasonable attorney fees arising out of, directly or indirectly, any claim of personal injury or death associated with such unintended or unauthorized use, even if such claim alleges that Motorola was negligent regarding the design or manufacture of the part. Motorola and  are registered trademarks of Motorola, Inc. Motorola, Inc. is an Equal Opportunity/Affirmative Action Employer.

How to reach us:

USA/EUROPE/Locations Not Listed: Motorola Literature Distribution; P.O. Box 5405, Denver, Colorado 80217.
1-303-675-2140 or 1-800-441-2447

JAPAN: Motorola Japan Ltd.; SPS, Technical Information Center, 3-20-1, Minami-Azabu. Minato-ku, Tokyo 106-8573 Japan.
81-3-3440-3569

ASIA/PACIFIC: Motorola Semiconductors H.K. Ltd.; Silicon Harbour Centre, 2 Dai King Street, Tai Po Industrial Estate, Tai Po, N.T., Hong Kong. 852-26668334

Customer Focus Center: 1-800-521-6274

Mfax™: RMFAX0@email.sps.mot.com – TOUCHTONE 1-602-244-6609
Motorola Fax Back System – US & Canada ONLY 1-800-774-1848
– <http://sps.motorola.com/mfax/>

HOME PAGE: <http://motorola.com/sps/>

