

## HX13050-S CAN Bus Transceiver

### General Description

The HX13050-S serves as the intermediary between the Controller Area Network (CAN) protocol controller and the physical bus, primarily designed for high-speed applications in passenger cars, with a maximum speed of up to 1 Mbaud. It facilitates differential transmission to the bus and differential reception for the CAN controller.

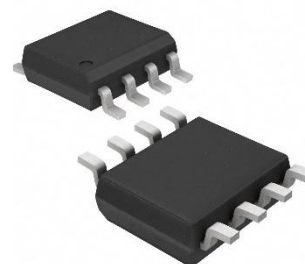

SOP-8

### Features

- Operating voltage range:  $VCC = 5V \pm 10\%$
- Fully compliant with the ISO 11898 standard
- High-speed operation (up to 1 Mbaud)
- Transceiver disengages from the bus in unpowered state (zero load)
- At least 110 nodes can be connected
- Very low-current standby mode with remote wake-up capability via the bus
- Differential receiver with high common-mode range for ElectroMagnetic Immunity (EMI)
- Transmit Data (TXD) dominant time-out function
- Bus pins protected against transients in automotive environments
- Thermally stabilized

### Applications

- Automotive electronics
- Security systems
- Industrial control automation
- Intelligent instrumentation
- Building automation systems
- Road traffic control automation
- Point-to-point and point-to-multipoint communications
- Level converter
- Serial servers

### PIN CONFIGURATIONS AND FUNCTIONS

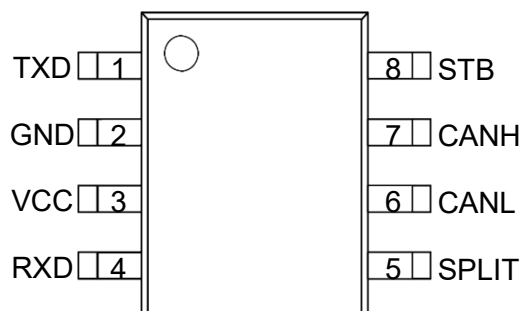

Pin Descriptio		
Pin	SYMBOL	Description
1	TXD	transmit data input
2	GND	ground supply
3	VCC	supply voltage, $VCC=5V \pm 10\%$
4	RXD	receive data output; reads out data from the bus lines
5	SPLIT	common-mode stabilization output
6	CANL	LOW-level CAN bus line
7	CANH	HIGH-level CAN bus line
8	STB	High speed and standby mode selection, low for high speed

www.haixindianzi.com

## Absolute Maximum Rating

SYMBOL	PARAMETER	MIN	MAX	UNIT
VCC	Supply voltage range	-0.3	+6	V
TXD, RXD, STB	MCU Side Port	-0.3	VCC+0.3	V
CANL, CANH, SPLIT	Bus-side port voltage	-60	+60	V
Vtr	Pin 6, 7 Transient Voltage	-200	+200	V
	storage temperature	-55	150	°C
	ambient temperature	-40	85	°C
	Welding temperature range		300	°C
SOP8	Continuous power consumption		400	mW

## SPECIFICATIONS

(VCC=5V±10%, Temp=TMIN~TMAX, typical values at VCC=+5V, Temp=25°C, unless otherwise noted)

## Bus Transmitter DC Characteristics

SYMBOL	PARAMETER	TESTCONDITIONS	MIN	MAX	UNIT	SYMBOL
VOH(D)	CANH output voltage (dominant)	VI=0V, STB=0V, RL=60Ω	2.9	3.4	4.5	
VOL(D)	CANL output voltage (dominant)	F1、2	0.8		1.5	
VO(R)	Bus Output Differential Voltage(implicit)	VI=3V,STB=0V, RL=60Ω, F1、2	2	2.5	3	V
VOD(D)	Bus Output Differential Voltage (dominant)	VI=0V,STB=0V, RL=60Ω, F1、2	1.5		3	V
VOD(R)	Bus Output Differential Voltage (implicit)	VI=3V, S=0V, F1、2	-0.012		0.012	V
		VI=3V, STB=0V, NO LOAD	-0.5		0.05	V
Vdom(TX)sym	dominant output voltage symmetry	Vdom(TX)sym=VCC- VCANH VCANL	-400		400	mV
VTXsym	Output Voltage Symmetry	VTXsym= VCANH + VCANL	0.9Vcc		1.1Vcc	V
VOC	Common mode output voltage	STB=0V, F 8	2	2.5	3	V
ΔVOC	Explicit and implicit common mode output voltage difference			30		mV
IOS	Short-circuit output current	CANH=-12V, CANL=open, F11	-105	-72		mA
		CANH=12V, CANL=open, F11		0.36	1	
		CANL=-12V, CANH=open, F11	-1	0.5		
		CANL=12V, CANH=open, F11		71	105	
IO(R)	Hidden output current	-27V<CANH<32V 0<VCC<5.25V	-2.0		2.5	mA
VIL	Low Level Input			0.36	1	
Ios Io(R)	Short-circuit output current Hidden output current	CANH=-12V, CANL=open, F 11	-1	0.5		
		CANH=12V, CANL=open, F 11		71	105	
		-27V<CANH<32V 0<VCC<5.25V	-2.0		2.5	mA

## Bus Transmitter Switch Characteristic

tPLH	Transmission delay (low to high)	STB=0V, F 4	25	65	120	ns
tPHL	Transmission delay (high to low)		25	45	90	ns
tr	Differential output rise delay time			25		ns
tf	Differential output fall delay time			50		ns
tEN	Enable time from listen mode to dominant	F 7			10	μs
tdom	Explicit timeout	F 10	300	450	700	μs
tBUS	Bus wake-up time		0.7		5	μs

Bus Receiver DC Paramete						
SYMBOL	PARAMETER	TESTCONDITIONS	MIN	MAX	UNIT	SYMBOL
V <sub>IT+</sub>	Positive Input Threshold	S=0V, F5		800	900	mV
V <sub>IT-</sub>	Negative Input Threshold		500	650		
V <sub>HYS</sub>	Comparator Threshold Hysteresis Interval		100	125		
V <sub>OH</sub>	High Level Output Voltage	IO=-2mA, F6	4	4.6		V
V <sub>OL</sub>	Low Level Output Voltage	IO=2Ma,F6		0.2	0.4	V
I <sub>(OFF)</sub>	Bus input current at power down	CANH or CANL=5V, Other pin=0V			5	μA
C <sub>I</sub>	CANH, CANL input capacitance to ground			13		pF
C <sub>ID</sub>	CANH, CANL Differential Input Capacitors			5		pF
R <sub>IN</sub>	CANH, CANL Input Resistance	TXD=3V, STB=0V	15	30	40	KΩ
R <sub>ID</sub>	CANH, CANL Differential Input Resistors		30		80	KΩ
R <sub>I</sub> match	RI(CANH), RIN(CANL) mismatches	CANH=CANL	-3%		3%	
V <sub>COM</sub>	Common mode voltage range		-12		12	V
Bus Receiver Switching Characteris						
t <sub>PLH</sub>	Propagation delay (low to high)	STB=0V or VCC F6	60	100	130	ns
t <sub>PHL</sub>	Propagation delay (high to low)		45	70	90	ns
t <sub>r</sub>	RXD signal rise time			8		ns
t <sub>f</sub>	RXD signal fall time			8		ns
Device Switching Character						
T <sub>d</sub> (LOOP1)	Loop delay 1, driver input to receiver output, implicit to explicit	STB=0V, F9	90		190	ns
T <sub>d</sub> (LOOP2)	Loop Delay 2, Driver Input to Receiver Output, Explicit to Implicit		90		190	ns
Over-temperature protectio						
T <sub>j</sub> (sd)	Over temperature shutdown		155	165	180	℃
TXD Pin Characteristi						
V <sub>O</sub>	Common mode stabilised output voltage	-500uA<I <sub>o</sub> <500uA	0.3VCC		0.7VCC	V
I <sub>O</sub> (stb)	leakage current	STB=2V,-12V<V <sub>O</sub> <12V	-5		5	μA
I <sub>IH</sub> (TXD)	TXD port high level input current	V <sub>I</sub> =VCC	-2		2	μA
I <sub>IL</sub> (TXD)	TXD Port Low Level Input Current	V <sub>I</sub> =0	-50		-10	μA
I <sub>O</sub> (off)	Current in TXD when VCC=0V	VCC=0V, TXD=5V			1	μA
V <sub>IH</sub>	Input High LowerLimit		2		VCC+0.3	V
V <sub>IL</sub>	Input Low Limit		-0.3		0.8	V
TXD <sub>O</sub>	TXD Port Dangle Voltage			H		logic
Power consumption characteristic						
I <sub>CC</sub>	Silent Mode Power Consumption	STB=VCC, V <sub>I</sub> =VCC		5	12	μA
	Dominant power consumption	V <sub>I</sub> =0V, S=0V LOAD=60Ω		50	70	mA
	Implicit power consumption	V <sub>I</sub> =VCC, S=0V NO LOAD		6	10	mA

**Menu** (1)H=high; L=low; X=no care

**Table 1 CAN Transceiver Truth**

Vcc	TXD <sup>(1)</sup>	STB <sup>(1)</sup>	CANH <sup>(1)</sup>	CANL <sup>(1)</sup>	BUS STATE	RXD <sup>(1)</sup>
4.5V~5.5V	L	L	H	L	dominant	L
4.5V~5.5V	H (or float)	X	0.5VCC	0.5VCC	implicit	H
4.5V~5.5V	X	H(or float)	0.5VCC	0.5VCC	implicit	<u>H</u>
0<VCC<4.5V	X	X	0V<VCANH<VCC	0V<VCANL<VCC	implicit	X

**Table 2 Driver Function**

INPUTS		OUTPUTS		Bus State
L	L	H	L	Dominate(dominant)
H (or floa)	X	Z	Z	Recessive(implicit)
X	H(or float)	Z	Z	Recessive(implicit)

**Table 3 Receiver Function**

VID=CANH-CANL	RXD <sup>(1)</sup>	Bus State <sup>(1)</sup>
VID≥0.9V	L	Dominate(dominant)
0.5< VID<0.9V		
VID≤0.5V	H	Recessive (implicit)
Open	H	Recessive (implicit)

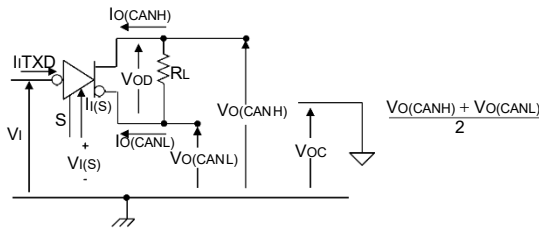

F1.Driver Voltage, Current Test Definitions

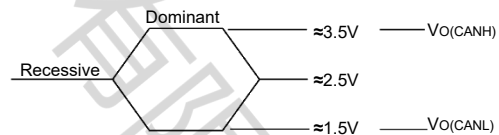

F2. Bus Logic Voltage Definition

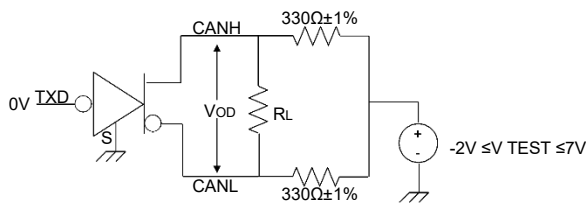

F3. Driver VOD Test Circuit

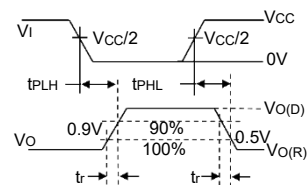
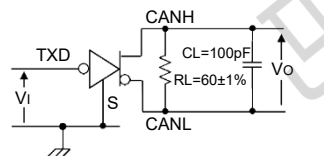

F4. Driver Test Circuit and Voltage Waveforms

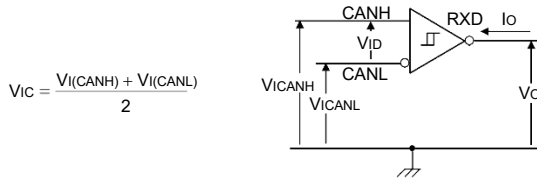

**F5. Receiver Voltage and Current Definitions**

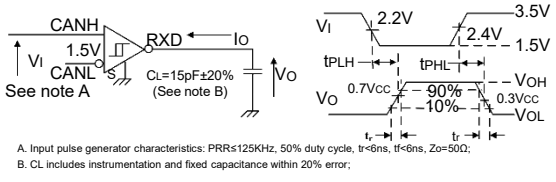

**F6. Receiver test circuit and voltage waveform**

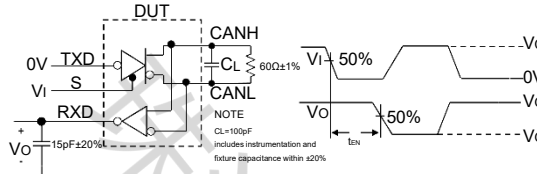

**F7. t<sub>EN</sub> Test Circuit and Voltage Waveforms**

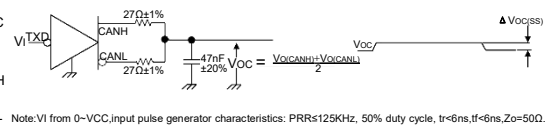

**F8. Common Mode Output Voltage Test and**

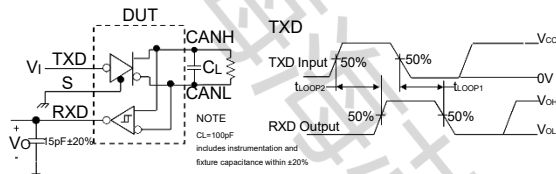

**F9. t(LOOP) Test Circuit and Waveforms**

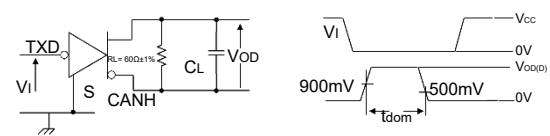

**F10. Revealed Timeout Test Circuit and Waveforms**

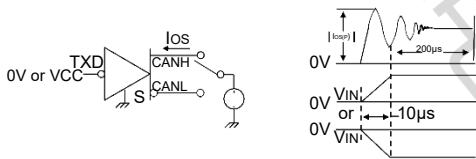

**F9. Driver Short Circuit Current Test Circuit and Waveforms**

## FUNCTIONAL BLOCK DIAGRAM

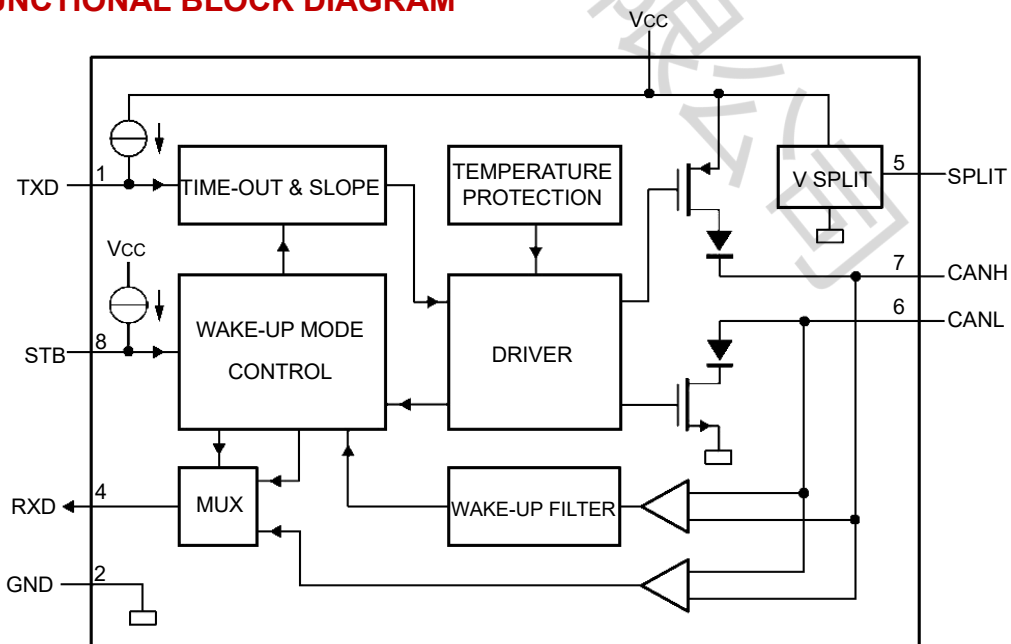

## DESCRIPTION

### Brief description

The HX13050-S is an interface chip that connects the CAN protocol controller with the physical bus. It can be used in trucks, buses, cars, industrial control, and other applications. With a data transmission rate of 1Mbps, the HX13050-S has the capability to transmit differential signals between the bus and the CAN protocol controller, fully compliant with the ISO 11898 standard.

### Short circuit protection

The HX13050-S's driver stage incorporates a current limit protection feature, designed to safeguard the circuit from shorts to the positive and negative supply voltages. In the event of a short-circuit, power consumption would rise, but thanks to the short-circuit protection function, the driver stage is protected from potential damage.

### Fail Safe

The TXD pin features a pull-up to VCC connection, ensuring that the bus remains in a recessive state when the TXD pin is not powered. The STB pin has a pull-up to VCC pass-through, ensuring that the transceiver remains in the standby state when the STB pin is not powered. In the event of a power supply drop, the TXD, STB, and RXD pins will become unconnected to prevent reverse power flow through these pins.

### Over Temperature Protection

The HX13050-S features an over-temperature protection function. When the junction temperature exceeds 160°C, the current of the driver stage is reduced. As the driver tube is the main energy-consuming component, reducing the current lowers power consumption, ultimately cooling the chip. Other parts of the chip continue to operate normally during this process.

### Significant Timeout Function

The TXD dominant timeout timer circuit is built-in to prevent the bus line from being driven to a permanently dominant state (blocking all network communications) if the TXD pin is forced permanently low due to a hardware or software application failure. The timer is triggered by a negative edge on the TXD pin.

If the low level on the TXD pin persists longer than the internal timer value ( $t_{dom}$ ), the transmitter is disabled, driving the bus into a recessive state. The timer is reset by a positive edge on the TXD pin.

### Control Modes

The control pin STB allows selection between two operation modes: high-speed mode and standby mode. In high-speed mode—the normal mode—the transceiver sends and receives data over the CANH and CANL buses by grounding the STB pin. In this mode, the differential receiver converts analogue data on the bus to digital data and outputs it via a multiplexer (MUX) to the RXD pin.

If the STB pin is left unconnected or connected to a high voltage level, it enters standby mode. In this mode, the transmitter and receiver are turned off, and the bus line is monitored by a low-power differential comparator. When a high voltage level is applied to the STB pin, it activates the low-power receiver and wake-up filter. As soon as the low-power differential comparator detects a dominant bus level above  $t_{BUS}$ , the RXD pin goes low.

## DIMENSIONAL DRAWINGS

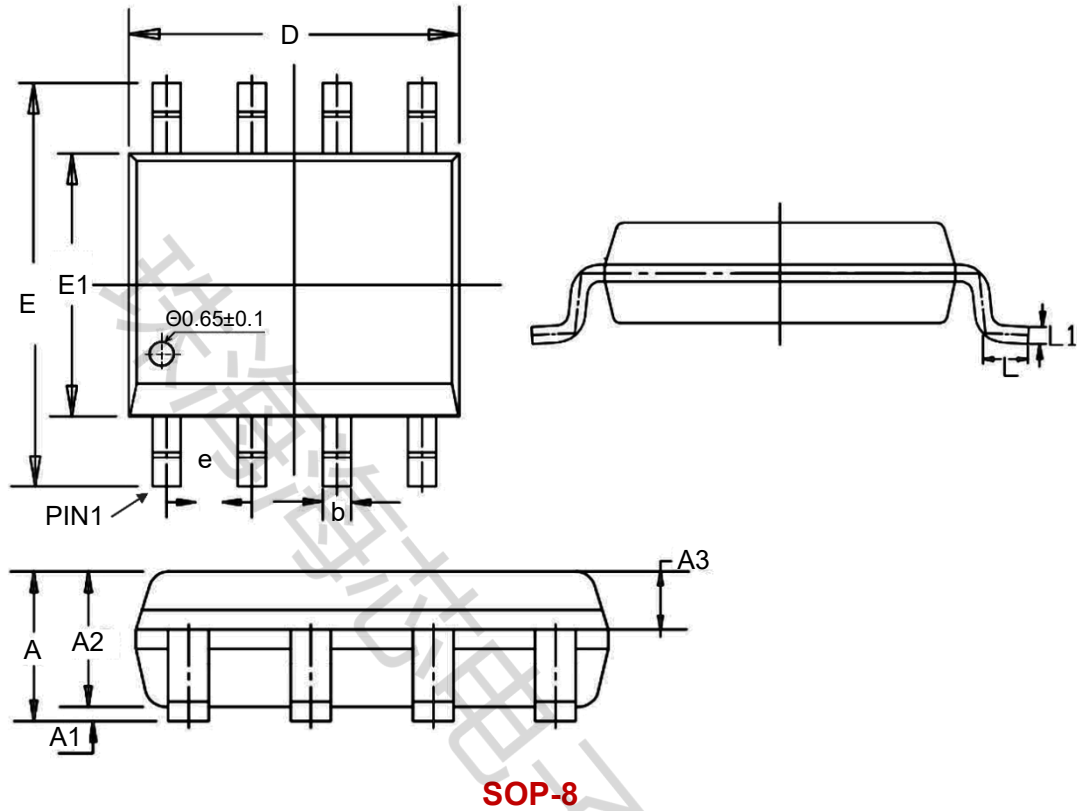

UNIT:mm

	MIN	NOM	MAX
A	1.450	1.550	1.650
A1	0.100	0.150	0.200
A2	1.300	1.400	1.500
A3	0.600	0.650	0.700
b	0.380		0.510
e	1.240	1.270	1.300
D	4.800	4.900	5.000
E	5.800	6.000	6.200
E1	3.800	3.900	4.000
L	0.450	0.600	0.750
L1		0.25BSC	

Part Number	Package Type	Package	quantity
HX13050-S	SOP-8	Taping	2500

## Disclaimer

All products due to improve reliability, function or design or for other reasons, product specifications and data are subject to change without notice.

Zhuhai Haixin Electronics Co., Ltd., branches, agents, employees, and all persons acting on its or their representatives (collectively, the "zhuhai Haixindianzi"), assumes no responsibility for any errors, inaccuracies or incomplete data contained in the table or any other any disclosure of any information related to the product.([www.haixindianzi.com](http://www.haixindianzi.com))

Zhuhai Haixin makes no guarantee, representation or warranty on the product for any particular purpose of any goods or continuous production. To the maximum extent permitted by applicable law on Zhuhai Haixin relinquished: (1) any application and all liability arising out of or use of any products; (2) any and all liability, including but not limited to special, consequential damages or incidental ; (3) any and all implied warranties, including a particular purpose, non-infringement and merchantability guarantee.

Statement on certain types of applications are based on knowledge of the product is often used in a typical application of the general product Haixin Zhuhai demand that the Zhuhai Haixin of. Statement on whether the product is suitable for a particular application is non-binding. It is the customer's responsibility to verify specific product features in the products described in the specification is appropriate for use in a particular application. Parameter data sheets and technical specifications can be provided may vary depending on the application and performance over time. All operating parameters, including typical parameters must be made by customer's technical experts validated for each customer application. Product specifications do not expand or modify Zhuhai Haixin purchasing terms and conditions, including but not limited to warranty herein.

Unless expressly stated in writing, Zhuhai Haixin products are not intended for use in medical, life saving, or life sustaining applications or any other application. Wherein Haixin product failure could lead to personal injury or death, use or sale of products used in Zhuhai Haixin such applications using client did not express their own risk. Contact your authorized Zhuhai Haixin people who are related to product design applications and other terms and conditions in writing.

The information provided in this document and the company's products without a license, express or implied, by estoppel or otherwise, to any intellectual property rights granted to the Haixin act or document. Product names and trademarks referred to herein are trademarks of their respective representatives will be all.