

Surface Mount Fast Recovery Rectifiers

Reverse Voltage - 50 to 1000 V

Forward Current - 1 A

FEATURES

- ◆ For surface mounted applications
- ◆ Low profile package
- ◆ Glass Passivated Chip Junction
- ◆ Easy to pick and place
- ◆ Fast reverse recovery time
- ◆ Lead free in comply with EU RoHS 2011/65/EU directives

MECHANICAL DATA

- ◆ Case: SOD-123FL
- ◆ Terminals: Solderable per MIL-STD-750, Method 2026
- ◆ Approx. Weight: 15mg /0.00053oz

Absolute Maximum Ratings and characteristics

Ratings at 25 °C ambient temperature unless otherwise specified.
Single phase half-wave 60 Hz, resistive or inductive load, for capacitive load current derate by 20 %.

Pinning

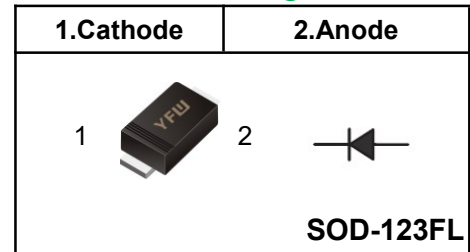

Mar ing Code

F1A	F1A
F1B	F1B
F1D	F1D
F1G	F1G
F1J	F1J
F1K	F1K
F1M	F1M

Parameter	Symbols	F1A	F1B	F1D	F1G	F1J	F1K	F1M	Units	
Maximum Repetitive Peak Reverse Voltage	V_{RRM}	50	100	200	400	600	800	1000	V	
Maximum RMS voltage	V_{RMS}	35	70	140	280	420	560	700	V	
Maximum DC Blocking Voltage	V_{DC}	50	100	200	400	600	800	1000	V	
Maximum Average Forward Rectified Current at $T_c = 125\text{ }^\circ\text{C}$	$I_{F(AV)}$	1							A	
Peak Forward Surge Current 8.3 ms Single Half Sine Wave Superimposed on Rated Load	I_{FSM}	30							A	
Maximum Instantaneous Forward Voltage at 1 A	V_F	1.3							V	
Maximum DC Reverse Current $T_a = 25\text{ }^\circ\text{C}$ at Rated DC Blocking Voltage $T_a = 125\text{ }^\circ\text{C}$	I_R	5 100							μA	
Typical Junction Capacitance at $V_R=4\text{V}, f=1\text{MHz}$	C_j	15							pF	
Maximum Reverse Recovery Time ⁽¹⁾	T_{rr}	150				250		500		nS
Typical Thermal Resistance ⁽²⁾	$R_{\theta JA}$	85							$^\circ\text{C/W}$	
Operating and Storage Temperature Range	T_j, T_{stg}	-55 ~ +150							$^\circ\text{C}$	

(1) Measured with $I_F=0.5\text{A}, I_R=1\text{A}, I_n=0.25\text{A}$

(2) P.C.B. mounted with 2.0" X 2.0" (5 X 5 cm) copper pad areas.

Fig.1 Forward Current Derating Curve

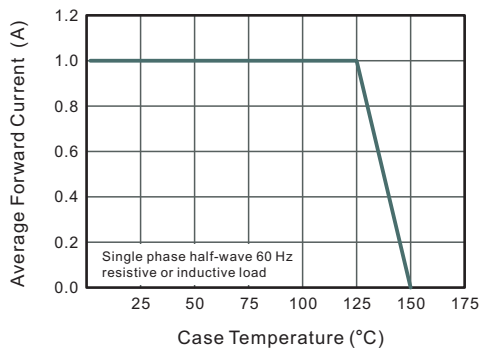

Fig.2 Typical Reverse Characteristics

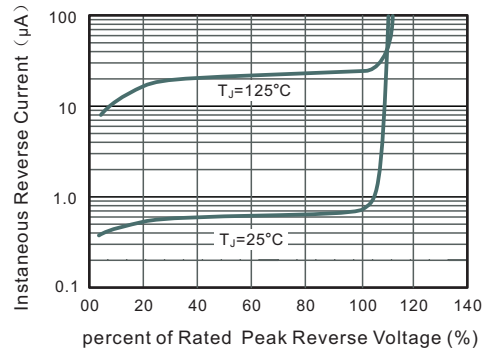

Fig.3 Typical Instantaneous Forward Characteristics

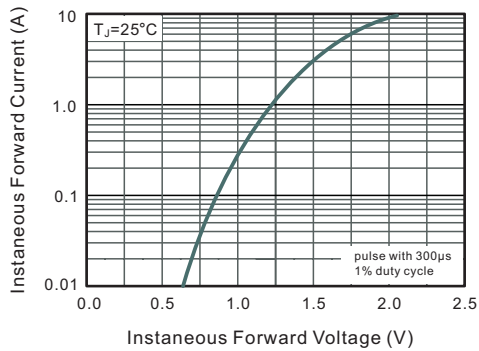

Fig.4 Typical Junction Capacitance

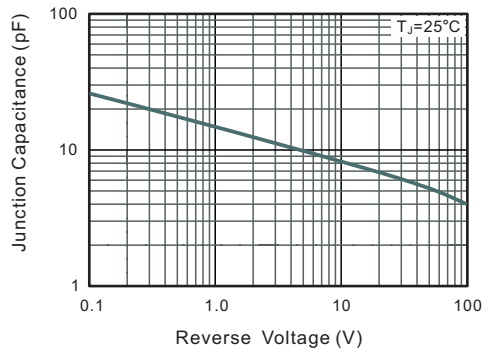
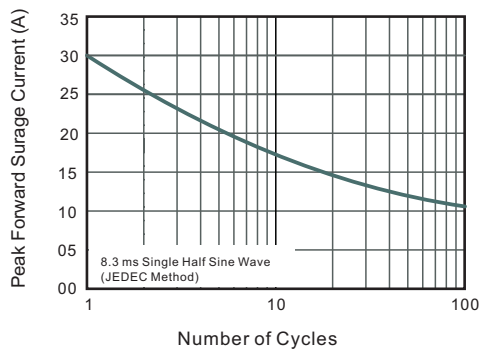
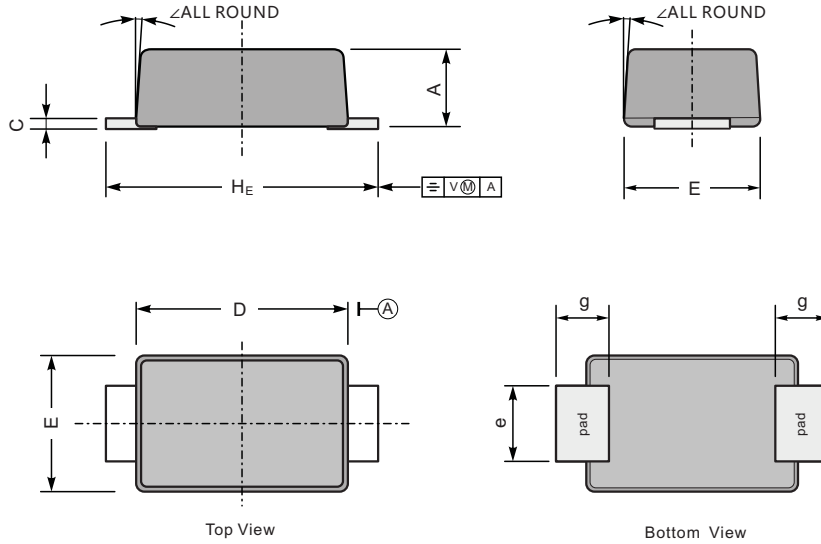

Fig.5 Maximum Non-Repetitive Peak Forward Surge Current



Package Outline SOD-123FL

Plastic surface mounted package; 2 leads



UNIT		A	C	D	E	e	g	H _E	\angle
mm	max	1.3	0.20	2.9	1.9	1.1	0.9	3.8	7°
	min	0.9	0.12	2.6	1.7	0.8	0.7	3.5	
mil	max	43	7.9	114	75	43	35	150	
	min	35	4.7	102	67	31	28	138	

The recommended mounting pad size

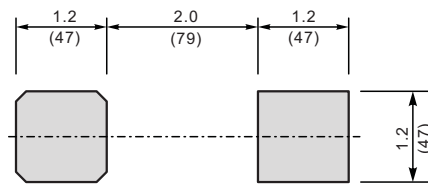

Unit: $\frac{\text{mm}}{\text{mil}}$

Summary of Packing Options

Package	Packing Description	Packing Quantity	Industry Standard
SOD-123FL	Tape/Reel, 13" reel	10000	EIA-481-1
	Tape/Reel, 7" reel	3000	EIA-481-1