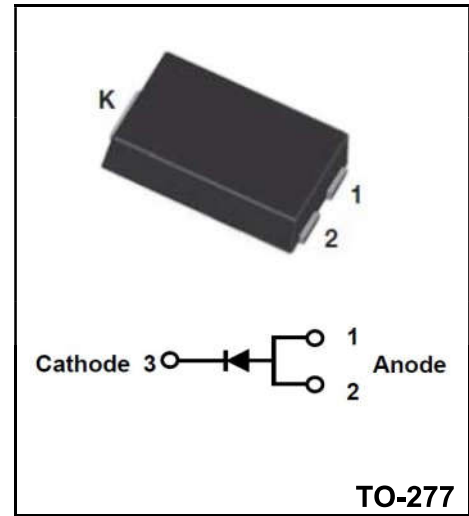

Trench MOS Barrier Schottky Rectifier
Reverse Voltage - 200 V
Forward Current - 10 A
FEATURES

- ◆Advanced trench technology
- ◆ Low forward voltage drop
- ◆ Low power losses
- ◆ High efficiency operation
- ◆Lead free in comply with EU RoHS 2011/65/EU directives

MECHANICAL DATA

- ◆Case: TO-277
- ◆Terminals: Solderable per MIL-STD-750, Method 2026

Maximum Ratings (Per Leg) at Ta=25°C unless otherwise specified

Parameter		Symbols	Value	Units
Maximum Repetitive Peak Reverse Voltage		V_{RRM}	200	V
Maximum RMS voltage		V_{RMS}	200	V
Maximum DC Blocking Voltage		V_{DC}	200	V
Maximum Average Forward Rectified Current	Per diode	$I_{F(AV)}$	10	A
Peak Forward Surge Current, 8.3ms Single Half Sine-wave superimposed on rated load per diode		I_{FSM}	280	A
Operating Temperature Range		T_J	-55 ~ +150	°C
Storage Temperature Range		T_{STG}	-55 ~ +150	°C
Typical Thermal Resistance Per diode(munted on FR-4 PCB)	TO-277	$R_{\theta JC}$	60	°C/W

Note1: Thermal resistance from Junction to case per leg mounted on heatsink.
Electrical Characteristics (Per Leg) unless otherwise specified

Characteristics		Symbols	Value		Units
Forward Voltage Drop(Note2)		V_F	Typ	Max	V
at $I_F=2A$ Instantaneous forward voltage per diode	TA=25°C		0.56	-	
	TA=125°C		0.50	-	
at $I_F=10A$ Instantaneous forward voltage per diode	TA=25°C		0.71	0.78	
	TA=125°C	0.65	-		
Instantaneous reverse current per diode at rated reverse voltage	TA=25°C	I_R	-	50	uA
	TA=125°C		-	10	mA

Note2: (1)Pulse test: 300 μs pulse width, 1 % duty cycle
(2) Pulse test: Pulse width 40 ms

Ratings and Characteristic Curves

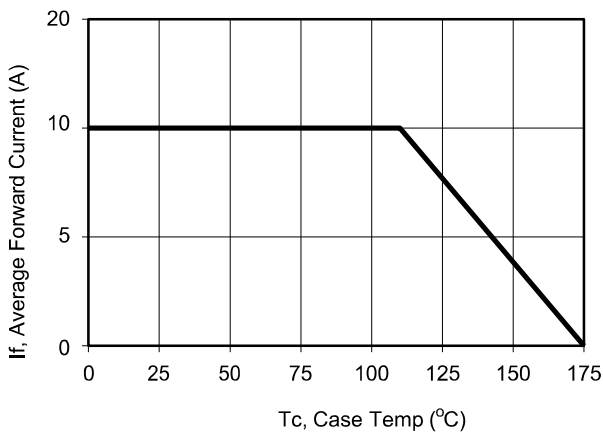

Current Derating, Case

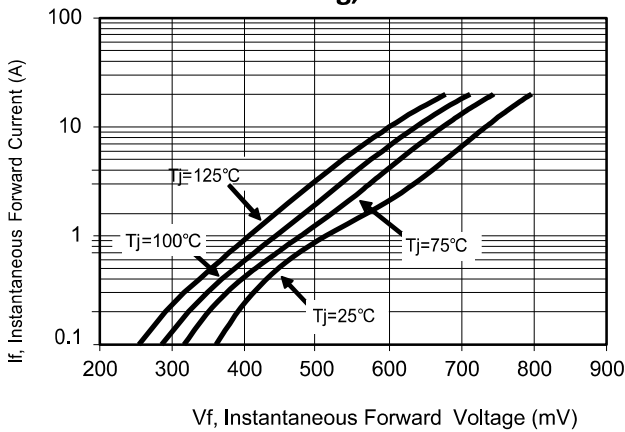

Typical Forward Voltage

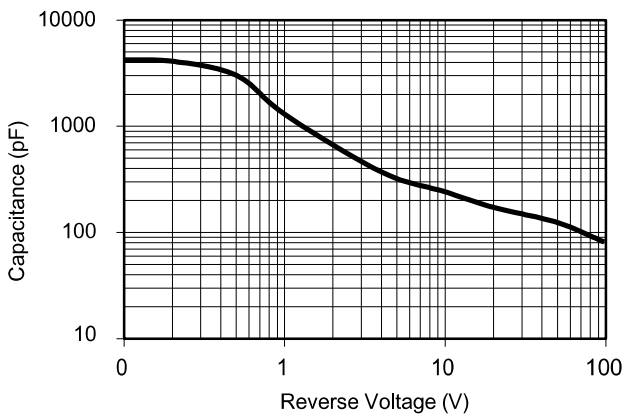

Typical Junction Capacitance

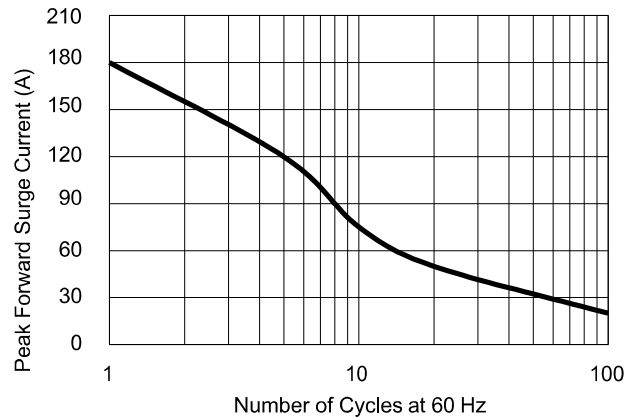

Maximum Repetitive Surge Current

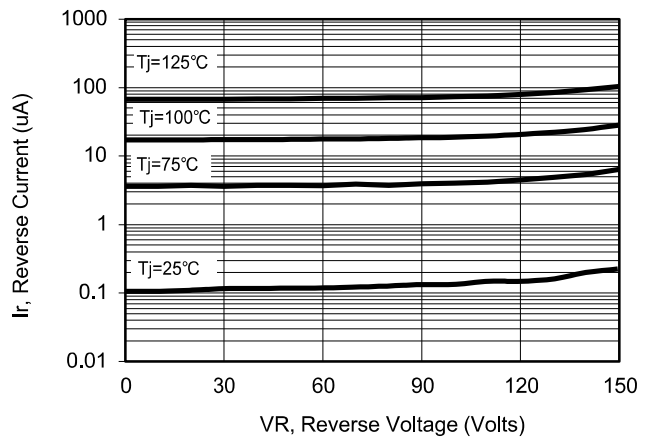

Typical Reverse Current

Package Outline TO-277

Plastic surface mounted package; 3 leads

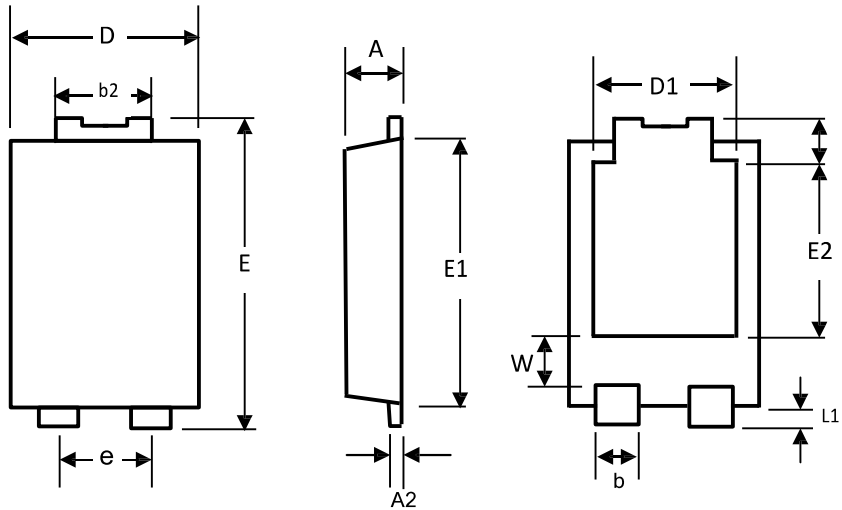

Dim	Min	Max
A	1.1	1.2
A2	0.3	0.4
b1	0.8	1
b2	1.7	1.9
D	3.9	4.1
D1	3.054	
E	6.4	6.6
e	1.84	
E1	5.3	5.5
E2	3.549	
L	0.8	1
L1	0.5	0.7
W	1.1	1.4

unit:mm

Mounting Pad Layout

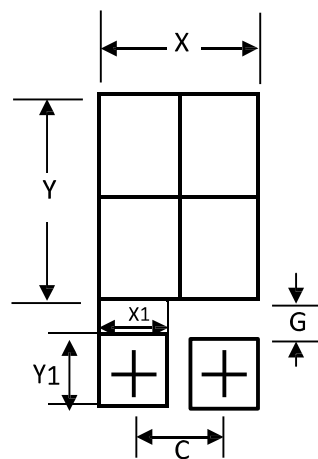

Dim	Min
C	1.8
G	0.9
X	3.4
X1	1.4
Y	4.9
Y1	1.4

unit:mm

Summary of Packing Options

Package	Packing Description	Packing Quantity	Industry Standard
TO-277	Tape/Reel,13"reel	5000	EIA-481-1