

60V N-Channel Power MOSFET

DESCRIPTION

The IRLR024NTR uses advanced trench technology to provide excellent RDS(ON), low gate charge. It can be used in a wide variety of applications.

KEY CHARACTERISTICS

- ① VDS = 60V, ID= 30A
RDS(ON) < 30mΩ @ VGS=10V
RDS(ON) < 40mΩ @ VGS=4.5V
- ② High density cell design for lower Rdson
- ③ Fully characterized avalanche voltage and current
- ④ Good stability and uniformity with high EAS
- ⑤ Excellent package for good heat dissipation

Application

- ① Power switching application
- ② Hard switched and High frequency circuits
- ③ Uninterruptible power supply

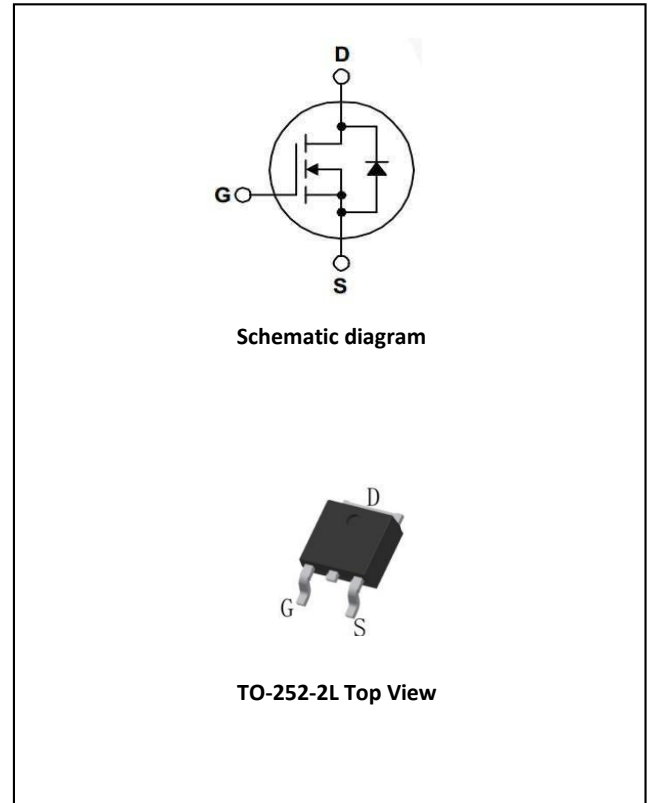

Package Marking And Ordering Information

Device Marking	Ordering Codes	Package	Product Code	Packing
IRLR024NTR	IRLR024NTR	TO-252	IRLR024NTR	Reel

Absolute Maximum Ratings (TA=25°C unless otherwise noted)

Parameter	Symbol	Limit	Unit
Drain-Source Voltage	V _{DS}	60	V
Gate-Source Voltage	V _{GS}	±20	V
Drain Current-Continuous	I _D	30	A
Drain Current-Pulsed ^(Note 1)	I _{DM}	80	A
Maximum Power Dissipation(Tc=25°C)	P _D	44	W
Single pulse avalanche energy ^(Note 2)	E _{AS}	56	mJ
Operating Junction and Storage Temperature Range	T _J , T _{STG}	-55 To 175	°C

Thermal Characteristic

Thermal Resistance, Junction-to-Case	$R_{\theta JC}$	3.4	$^{\circ}\text{C}/\text{W}$
--------------------------------------	-----------------	-----	-----------------------------

Electrical Characteristics (TA=25 $^{\circ}\text{C}$ unless otherwise noted)

Parameter	Symbol	Condition	Min	Typ	Max	Unit
Off Characteristics						
Drain-Source Breakdown Voltage	BV_{DSS}	$V_{GS}=0V, I_D=250\mu A$	60	-	-	V
Zero Gate Voltage Drain Current	I_{DSS}	$V_{DS}=60V, V_{GS}=0V$	-	-	1	μA
Gate-Body Leakage Current	I_{GSS}	$V_{GS}=\pm 20V, V_{DS}=0V$	-	-	± 100	nA
On Characteristics						
Gate Threshold Voltage	$V_{GS(th)}$	$V_{DS}=V_{GS}, I_D=250\mu A$	1.3	1.8	2.3	V
Drain-Source On-State Resistance ^(Note 3)	$R_{DS(ON)}$	$V_{GS}=10V, I_D=10A$	-	25	30	m Ω
		$V_{GS}=4.5V, I_D=10A$	-	30	40	
Forward Transconductance	g_{FS}	$V_{DS}=5V, I_D=10A$	-	11	-	S
Dynamic Characteristics						
Input Capacitance	C_{iss}	$V_{DS}=25V, V_{GS}=0V,$ $f=1.0\text{MHz}$	-	670	-	pF
Output Capacitance	C_{oss}		-	76	-	pF
Reverse Transfer Capacitance	C_{rss}		-	66	-	pF
Switching Characteristics ^(Note 4)						
Turn-on Delay Time	$t_{d(on)}$	$V_{DD}=30V, I_D=10A,$ $V_{GS}=10V, R_{GEN}=10\Omega$	-	19.2	-	nS
Turn-on Rise Time	t_r		-	6.4	-	nS
Turn-Off Delay Time	$t_{d(off)}$		-	29.2	-	nS
Turn-Off Fall Time	t_f		-	8.2	-	nS
Total Gate Charge	Q_g	$V_{DS}=48V, I_D=10A$ $V_{GS}=10V$	-	21	-	nC
Gate-Source Charge	Q_{gs}		-	5	-	nC
Gate-Drain Charge	Q_{gd}		-	6.5	-	nC
Drain-Source Diode Characteristics						
Diode Forward Voltage	V_{SD}	$V_{GS}=0V, I_S=20A$	-	-	1.2	V
Reverse Recovery Time	T_{rr}	$T_j=25^{\circ}\text{C}, I_F=10A, di/dt=100A/\mu S$ ^(note3)	-	33.6	-	nS
Reverse Recovery Charge	Q_{rr}		-	32.1	-	nC

Notes:

- 1.Repetitive Rating: Pulse width limited by maximum junction temperature.
- 2.EAS condition : $T_j=25^{\circ}\text{C}, V_{DD}=30V, V_{GS}=10V, L=0.5\text{mH}, R_g=25\Omega$
- 3.Pulse Test: Pulse Width $\leq 300\mu s$, Duty Cycle $\leq 2\%$.
- 4.Guaranteed by design, not subject to production.

Characteristics Curves

Figure 1 Output Characteristics

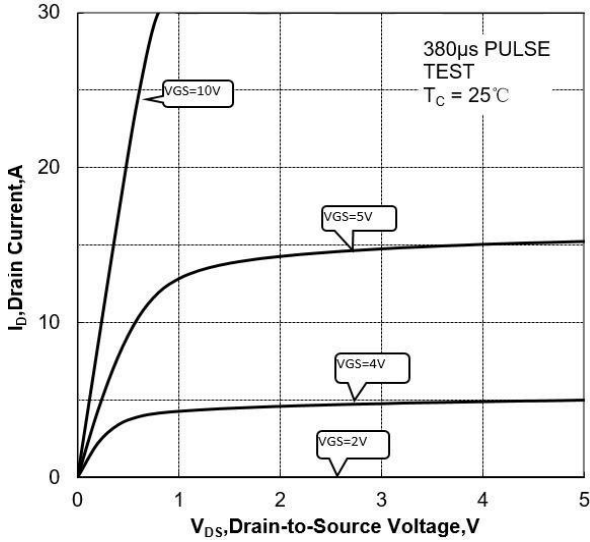

Figure 2 Transfer Characteristics

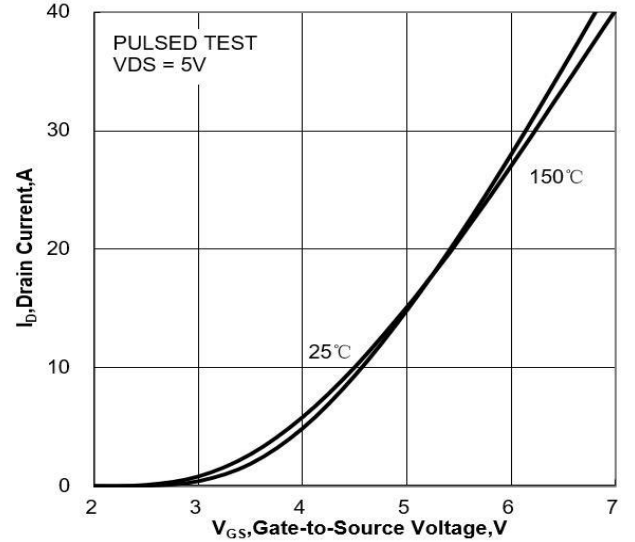

Figure 3 On-Resistance vs. ID and VGS

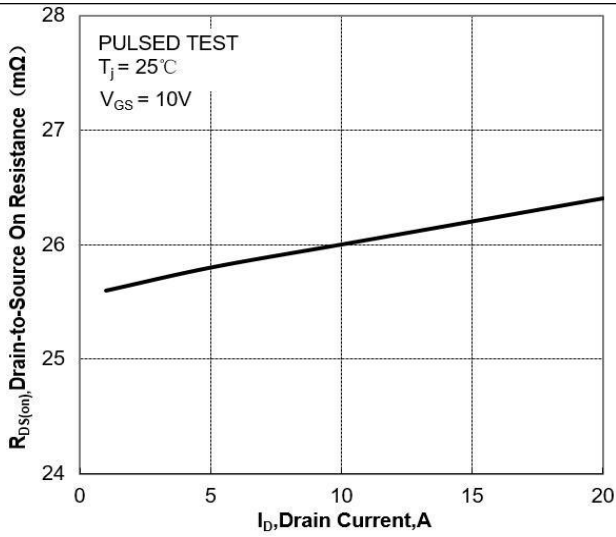

Figure 4 On-Resistance vs. Junction Temperature

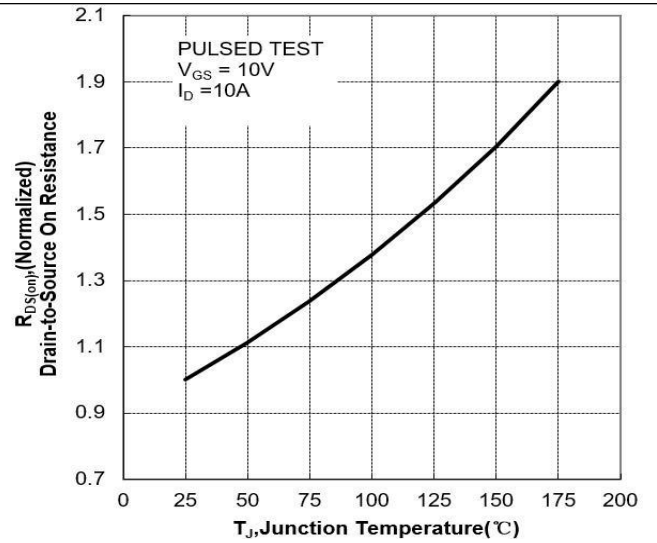

Figure 5 On-Resistance vs. VGS

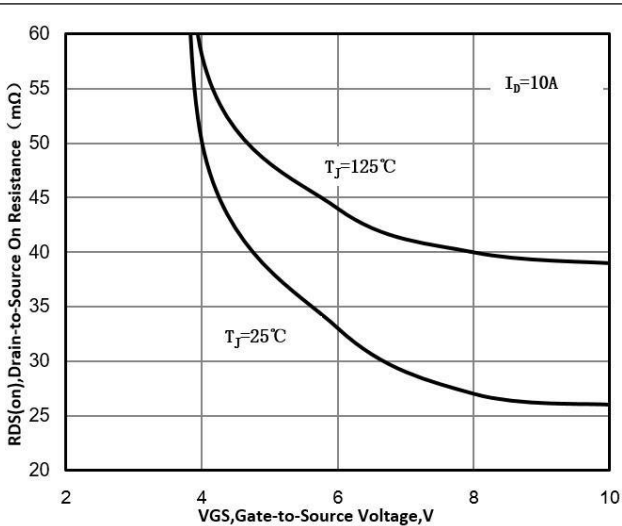

Figure 6 Body Diode Forward Voltage

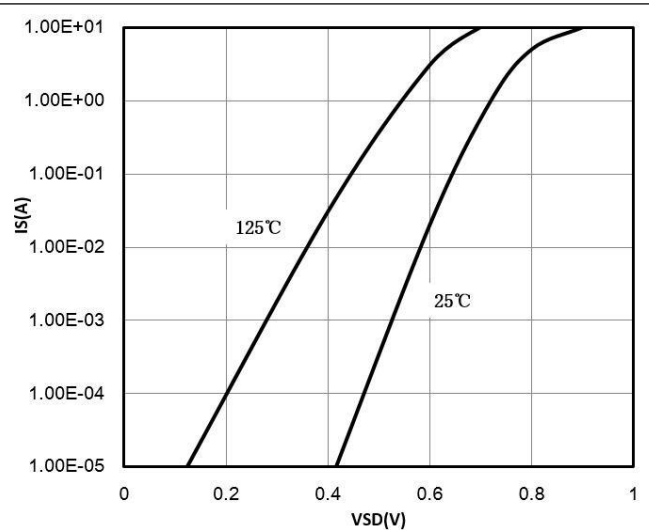

Figure 7 Gate-Charge Characteristics

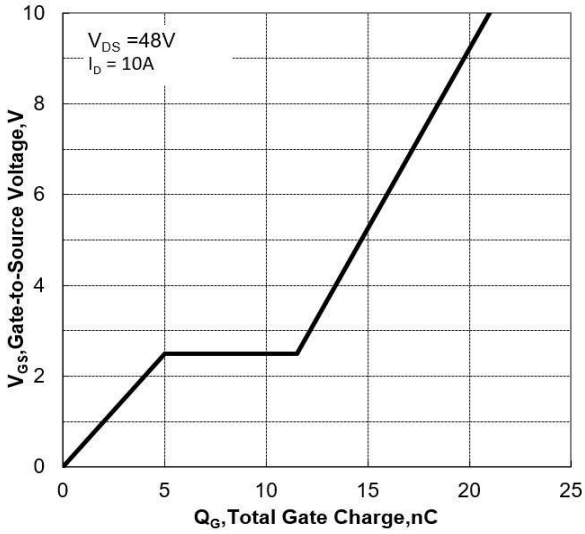

Figure 8 Capacitance Characteristics

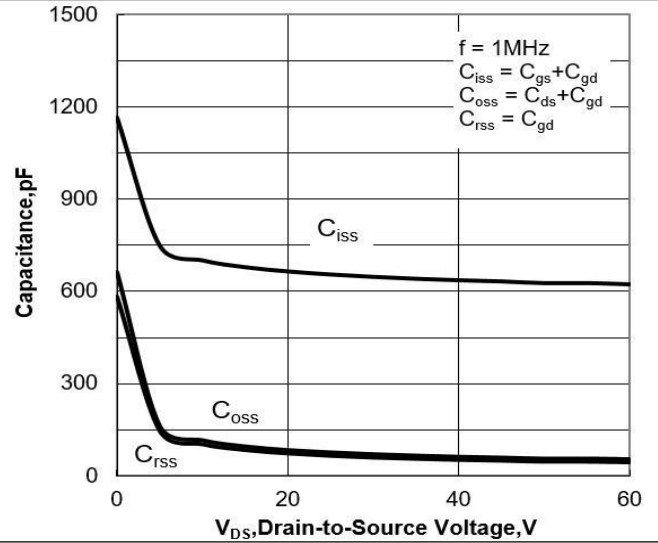

Figure 9 Maximum Forward Biased Safe Operation Area

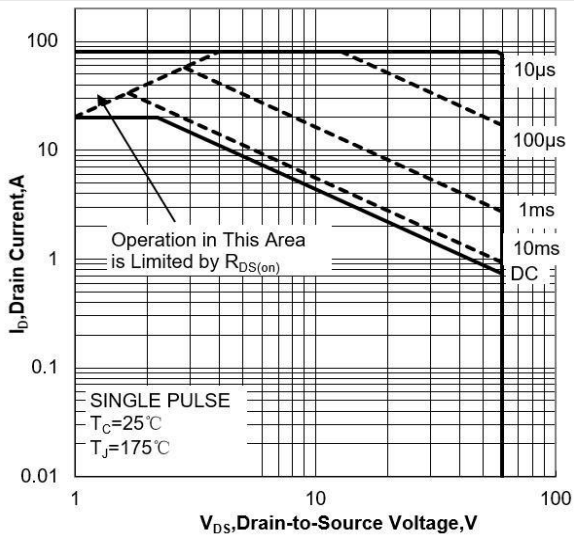

Figure 10 Single Pulse Power Rating Junction-to-Ambient

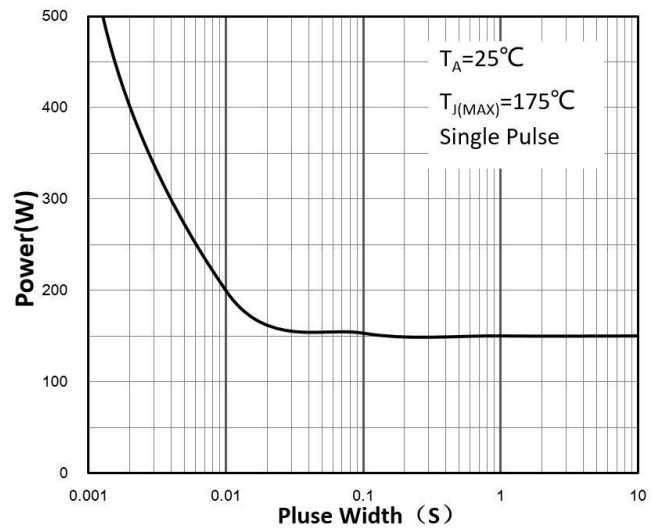
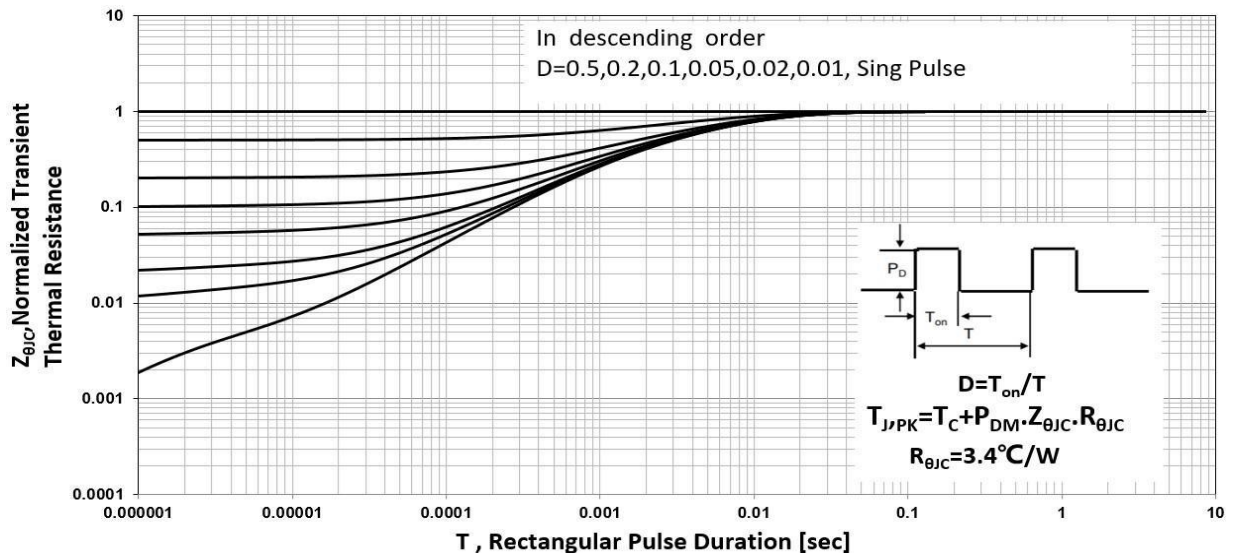
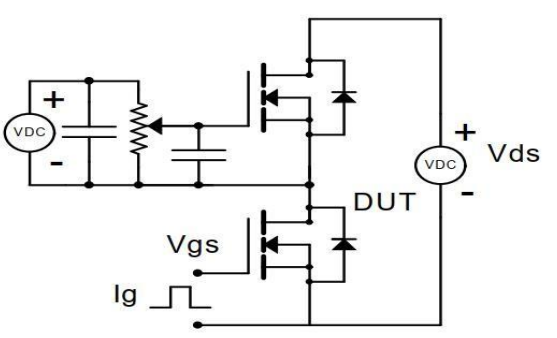
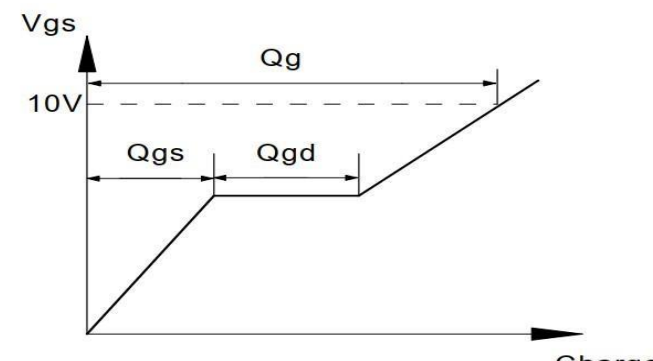
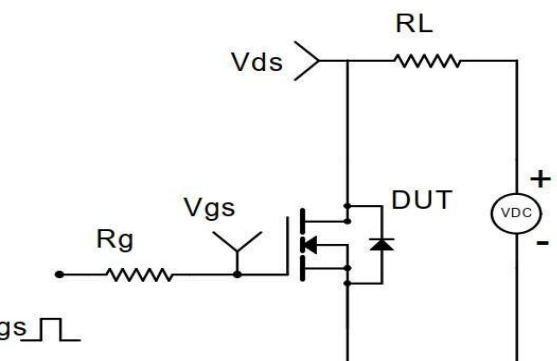
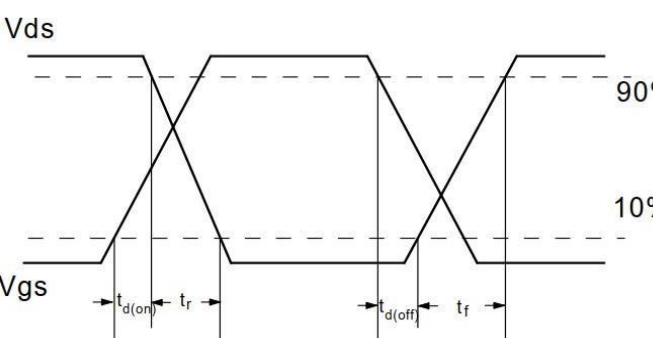
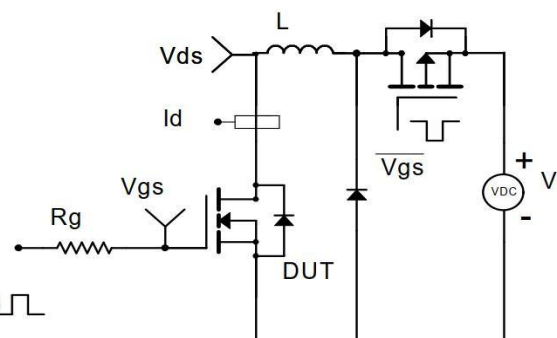
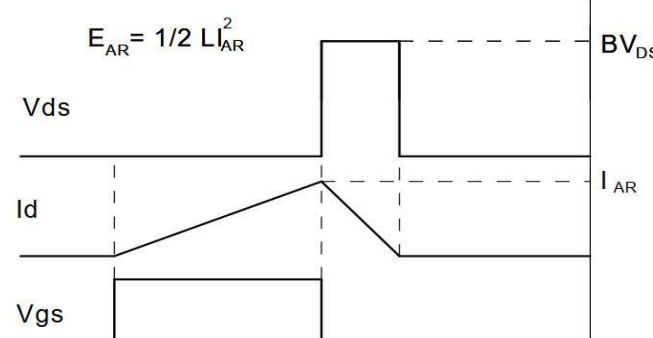
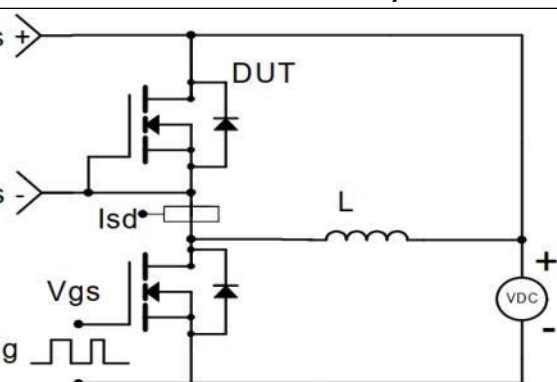
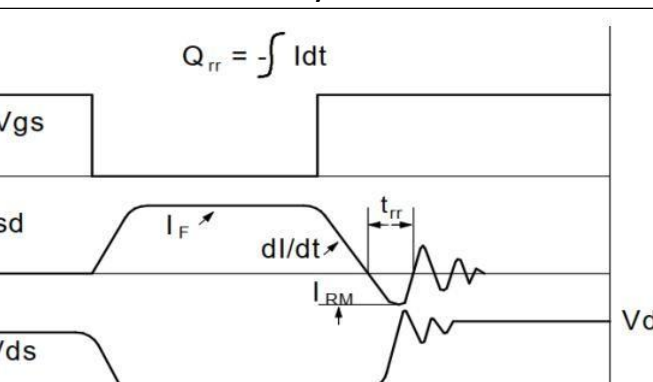

Figure 11 Normalized Maximum Transient Thermal Impedance



Test Circuit and Waveform

<p style="text-align: center;">Gate Charge Test Circuit</p> 	<p style="text-align: center;">Gate Charge Test Waveform</p> 
<p style="text-align: center;">Resistive Switching Test Circuit</p> 	<p style="text-align: center;">Resistive Switching Test Waveforms</p> 
<p style="text-align: center;">Unclamped Inductive Switching (UIS) Test Circuit</p> 	<p style="text-align: center;">Unclamped Inductive Switching (UIS) Test Waveforms</p> 
<p style="text-align: center;">Diode Recovery Test Circuit</p> 	<p style="text-align: center;">Diode Recovery Test Waveforms</p> 

Package Description

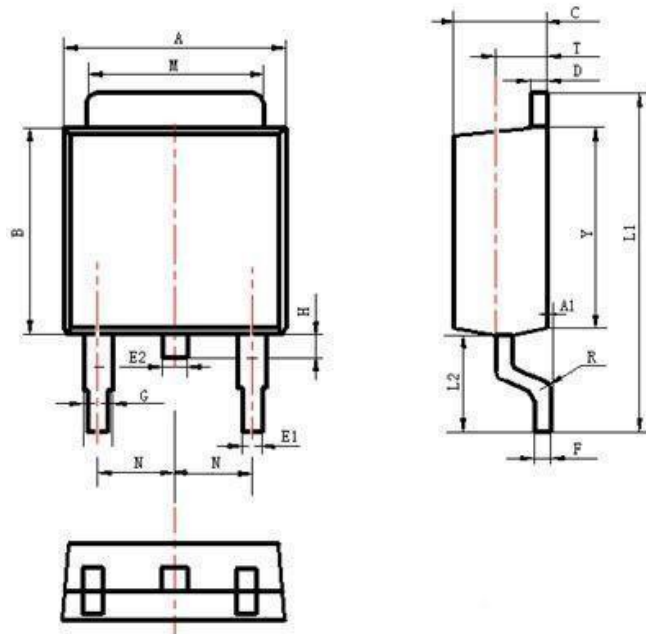

Items	Values(mm)	
	MIN	MAX
A	6.30	6.90
A1	0	0.13
B	5.70	6.30
C	2.10	2.50
D	0.30	0.60
E1	0.60	0.90
E2	0.70	1.00
F	0.30	0.60
G	0.70	1.20
L1	9.60	10.50
L2	2.70	3.10
H	0.60	1.00
M	5.10	5.50
N	2.09	2.49
R	0.3	
T	1.40	1.60
Y	5.10	6.30

TO-252 Package



NOTE:

1. Exceeding the maximum ratings of the device in performance may cause damage to the device, even the permanent failure, which may affect the dependability of the machine. Please do not exceed the absolute maximum ratings of the device when circuit designing.
2. When installing the heat sink, please pay attention to the torsional moment and the smoothness of the heat sink.
3. MOSFETs is the device which is sensitive to the static electricity, it is necessary to protect the device from being damaged by the static electricity when using it.
4. Shenzhen Minos reserves the right to make changes in this specification sheet and is subject to change without prior notice.

CONTACT:

深圳市迈诺斯科技有限公司（总部）

地址：深圳市福田区华富街道田面社区深南中路4026号田面城市大厦22B-22C

邮编：518025

电话：0755-83273777