

MC14001B Series

B-Suffix Series CMOS Gates

MC14001B, MC14011B, MC14023B,
MC14025B, MC14071B, MC14073B,
MC14081B, MC14082B

The B Series logic gates are constructed with P and N channel enhancement mode devices in a single monolithic structure (Complementary MOS). Their primary use is where low power dissipation and/or high noise immunity is desired.

Features

- Supply Voltage Range = 3.0 Vdc to 18 Vdc
- All Outputs Buffered
- Capable of Driving Two Low-power TTL Loads or One Low-power Schottky TTL Load Over the Rated Temperature Range.
- Double Diode Protection on All Inputs Except: Triple Diode Protection on MC14011B and MC14081B
- Pin-for-Pin Replacements for Corresponding CD4000 Series B Suffix Devices
- NLV Prefix for Automotive and Other Applications Requiring Unique Site and Control Change Requirements; AEC-Q100 Qualified and PPAP Capable
- These Devices are Pb-Free and are RoHS Compliant

MAXIMUM RATINGS (Voltages Referenced to V_{SS})

Symbol	Parameter	Value	Unit
V_{DD}	DC Supply Voltage Range	-0.5 to +18.0	V
V_{in}, V_{out}	Input or Output Voltage Range (DC or Transient)	-0.5 to $V_{DD} + 0.5$	V
I_{in}, I_{out}	Input or Output Current (DC or Transient) per Pin	± 10	mA
P_D	Power Dissipation, per Package (Note 1)	500	mW
T_A	Ambient Temperature Range	-55 to +125	$^{\circ}C$
T_{stg}	Storage Temperature Range	-65 to +150	$^{\circ}C$
T_L	Lead Temperature (8-Second Soldering)	260	$^{\circ}C$
V_{ESD}	ESD Withstand Voltage Human Body Model Machine Model Charged Device Model	> 3000 > 300 N/A	V

Stresses exceeding those listed in the Maximum Ratings table may damage the device. If any of these limits are exceeded, device functionality should not be assumed, damage may occur and reliability may be affected.

1. Temperature Derating: "D/DW" Packages: -7.0 mW/ $^{\circ}C$ From 65 $^{\circ}C$ To 125 $^{\circ}C$

This device contains protection circuitry to guard against damage due to high static voltages or electric fields. However, precautions must be taken to avoid applications of any voltage higher than maximum rated voltages to this high-impedance circuit. For proper operation, V_{in} and V_{out} should be constrained to the range $V_{SS} \leq (V_{in} \text{ or } V_{out}) \leq V_{DD}$.

Unused inputs must always be tied to an appropriate logic voltage level (e.g., either V_{SS} or V_{DD}). Unused outputs must be left open.



ON Semiconductor®

<http://onsemi.com>



SOIC-14
D SUFFIX
CASE 751A



TSSOP-14
DT SUFFIX
CASE 948G

MARKING DIAGRAMS



SOIC-14

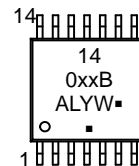

TSSOP-14

- xx = Specific Device Code
- A = Assembly Location
- WL, L = Wafer Lot
- YY, Y = Year
- WW, W = Work Week
- G or ■ = Pb-Free Package

(Note: Microdot may be in either location)

DEVICE INFORMATION

Device	Description
MC14001B	Quad 2-Input NOR Gate
MC14011B	Quad 2-Input NAND Gate
MC14023B	Triple 3-Input NAND Gate
MC14025B	Triple 3-Input NOR Gate
MC14071B	Quad 2-Input OR Gate
MC14073B	Triple 3-Input AND Gate
MC14081B	Quad 2-Input AND Gate
MC14082B	Dual 4-Input AND Gate

ORDERING INFORMATION

See detailed ordering and shipping information in the package dimensions section on page 8 of this data sheet.

MC14001B Series

LOGIC DIAGRAMS



V_{DD} = PIN 14
 V_{SS} = PIN 7
 FOR ALL DEVICES

PIN ASSIGNMENTS



NC = NO CONNECTION

MC14001B Series

ELECTRICAL CHARACTERISTICS (Voltages Referenced to V_{SS})

Characteristic	Symbol	V _{DD} Vdc	- 55°C		25°C			125°C		Unit	
			Min	Max	Min	Typ (Note 2)	Max	Min	Max		
Output Voltage V _{in} = V _{DD} or 0	"0" Level V _{OL}	5.0	-	0.05	-	0	0.05	-	0.05	Vdc	
		10	-	0.05	-	0	0.05	-	0.05		
		15	-	0.05	-	0	0.05	-	0.05		
	"1" Level V _{in} = 0 or V _{DD}	V _{OH}	5.0	4.95	-	4.95	5.0	-	4.95		-
			10	9.95	-	9.95	10	-	9.95		-
			15	14.95	-	14.95	15	-	14.95		-
Input Voltage (V _O = 4.5 or 0.5 Vdc) (V _O = 9.0 or 1.0 Vdc) (V _O = 13.5 or 1.5 Vdc)	"0" Level V _{IL}	5.0	-	1.5	-	2.25	1.5	-	1.5	Vdc	
		10	-	3.0	-	4.50	3.0	-	3.0		
		15	-	4.0	-	6.75	4.0	-	4.0		
	"1" Level (V _O = 0.5 or 4.5 Vdc) (V _O = 1.0 or 9.0 Vdc) (V _O = 1.5 or 13.5 Vdc)	V _{IH}	5.0	3.5	-	3.5	2.75	-	3.5		-
			10	7.0	-	7.0	5.50	-	7.0		-
			15	11	-	11	8.25	-	11		-
Output Drive Current (V _{OH} = 2.5 Vdc) (V _{OH} = 4.6 Vdc) (V _{OH} = 9.5 Vdc) (V _{OH} = 13.5 Vdc)	Source I _{OH}	5.0	-3.0	-	-2.4	-4.2	-	-1.7	-	mAdc	
		5.0	-0.64	-	-0.51	-0.88	-	-0.36	-		
		10	-1.6	-	-1.3	-2.25	-	-0.9	-		
		15	-4.2	-	-3.4	-8.8	-	-2.4	-		
	Sink I _{OL}	5.0	0.64	-	0.51	0.88	-	0.36	-		
		10	1.6	-	1.3	2.25	-	0.9	-		
		15	4.2	-	3.4	8.8	-	2.4	-		
Input Current	I _{in}	15	-	±0.1	-	±0.00001	±0.1	-	±1.0	μAdc	
Input Capacitance (V _{in} = 0)	C _{in}	-	-	-	-	5.0	7.5	-	-	pF	
Quiescent Current (Per Package)	I _{DD}	5.0	-	0.25	-	0.0005	0.25	-	7.5	μAdc	
		10	-	0.5	-	0.0010	0.5	-	15		
		15	-	1.0	-	0.0015	1.0	-	30		
Total Supply Current (Notes 3, 4) (Dynamic plus Quiescent, Per Gate, C _L = 50 pF)	I _T	5.0	I _T = (0.3 μA/kHz) f + I _{DD} /N							μAdc	
		10	I _T = (0.6 μA/kHz) f + I _{DD} /N								
		15	I _T = (0.9 μA/kHz) f + I _{DD} /N								

Product parametric performance is indicated in the Electrical Characteristics for the listed test conditions, unless otherwise noted. Product performance may not be indicated by the Electrical Characteristics if operated under different conditions.

2. Data labelled "Typ" is not to be used for design purposes but is intended as an indication of the IC's potential performance.
3. The formulas given are for the typical characteristics only at 25°C.
4. To calculate total supply current at loads other than 50 pF:

$$I_T(C_L) = I_T(50 \text{ pF}) + (C_L - 50) \text{ Vfk}$$

where: I_T is in μA (per package), C_L in pF, V = (V_{DD} - V_{SS}) in volts, f in kHz is input frequency, and k = 0.001 x the number of exercised gates per package.

MC14001B Series

B-SERIES GATE SWITCHING TIMES

SWITCHING CHARACTERISTICS (Note 5) ($C_L = 50 \text{ pF}$, $T_A = 25^\circ\text{C}$)

Characteristic	Symbol	V_{DD} Vdc	Min	Typ (Note 6)	Max	Unit
Output Rise Time, All B-Series Gates $t_{TLH} = (1.35 \text{ ns/pF}) C_L + 33 \text{ ns}$ $t_{TLH} = (0.60 \text{ ns/pF}) C_L + 20 \text{ ns}$ $t_{TLH} = (0.40 \text{ ns/pF}) C_L + 20 \text{ ns}$	t_{TLH}	5.0 10 15	- - -	100 50 40	200 100 80	ns
Output Fall Time, All B-Series Gates $t_{THL} = (1.35 \text{ ns/pF}) C_L + 33 \text{ ns}$ $t_{THL} = (0.60 \text{ ns/pF}) C_L + 20 \text{ ns}$ $t_{THL} = (0.40 \text{ ns/pF}) C_L + 20 \text{ ns}$	t_{THL}	5.0 10 15	- - -	100 50 40	200 100 80	ns
Propagation Delay Time MC14001B, MC14011B only $t_{PLH}, t_{PHL} = (0.90 \text{ ns/pF}) C_L + 80 \text{ ns}$ $t_{PLH}, t_{PHL} = (0.36 \text{ ns/pF}) C_L + 32 \text{ ns}$ $t_{PLH}, t_{PHL} = (0.26 \text{ ns/pF}) C_L + 27 \text{ ns}$ All Other 2, 3, and 4 Input Gates $t_{PLH}, t_{PHL} = (0.90 \text{ ns/pF}) C_L + 115 \text{ ns}$ $t_{PLH}, t_{PHL} = (0.36 \text{ ns/pF}) C_L + 47 \text{ ns}$ $t_{PLH}, t_{PHL} = (0.26 \text{ ns/pF}) C_L + 37 \text{ ns}$ 8-Input Gates (MC14068B, MC14078B) $t_{PLH}, t_{PHL} = (0.90 \text{ ns/pF}) C_L + 155 \text{ ns}$ $t_{PLH}, t_{PHL} = (0.36 \text{ ns/pF}) C_L + 62 \text{ ns}$ $t_{PLH}, t_{PHL} = (0.26 \text{ ns/pF}) C_L + 47 \text{ ns}$	t_{PLH}, t_{PHL}	5.0 10 15 5.0 10 15 5.0 10 15	- - - - - - - - -	125 50 40 160 65 50 200 80 60	250 100 80 300 130 100 350 150 110	ns

5. The formulas given are for the typical characteristics only at 25°C .

6. Data labelled "Typ" is not to be used for design purposes but is intended as an indication of the IC's potential performance.



*All unused inputs of AND, NAND gates must be connected to V_{DD} .
 All unused inputs of OR, NOR gates must be connected to V_{SS} .

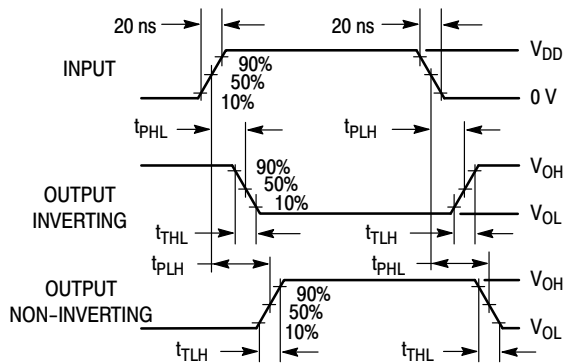

Figure 1. Switching Time Test Circuit and Waveforms

MC14001B Series

CIRCUIT SCHEMATIC NOR, OR GATES

MC14001B, MC14071B
One of Four Gates Shown



*Inverter omitted in MC14001B

MC14025B
One of Three Gates Shown



*Inverter omitted in MC14025B

CIRCUIT SCHEMATIC NAND, AND GATES

MC14023B, MC14073B
One of Three Gates Shown



*Inverter omitted in MC14023B

MC14011B, MC14081B
One of Four Gates Shown



*Inverter omitted in MC14011B

MC14001B Series

TYPICAL B-SERIES GATE CHARACTERISTICS

N-CHANNEL DRAIN CURRENT (SINK)

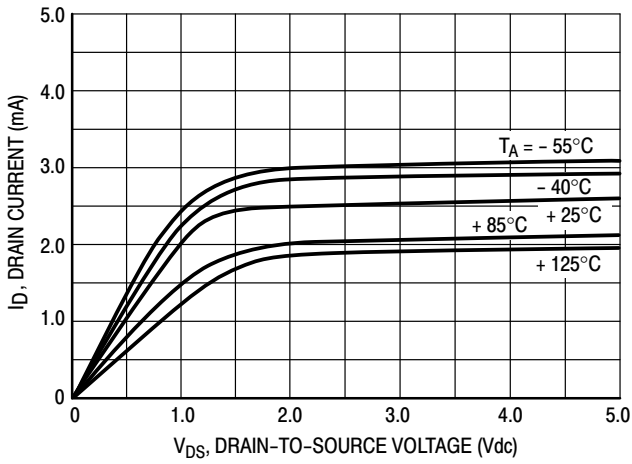

Figure 2. $V_{GS} = 5.0 \text{ Vdc}$

P-CHANNEL DRAIN CURRENT (SOURCE)



Figure 3. $V_{GS} = -5.0 \text{ Vdc}$



Figure 4. $V_{GS} = 10 \text{ Vdc}$



Figure 5. $V_{GS} = -10 \text{ Vdc}$



Figure 6. $V_{GS} = 15 \text{ Vdc}$



Figure 7. $V_{GS} = -15 \text{ Vdc}$

These typical curves are not guarantees, but are design aids.
 Caution: The maximum rating for output current is 10 mA per pin.

MC14001B Series

TYPICAL B-SERIES GATE CHARACTERISTICS (cont'd)

VOLTAGE TRANSFER CHARACTERISTICS



Figure 8. $V_{DD} = 5.0 \text{ Vdc}$

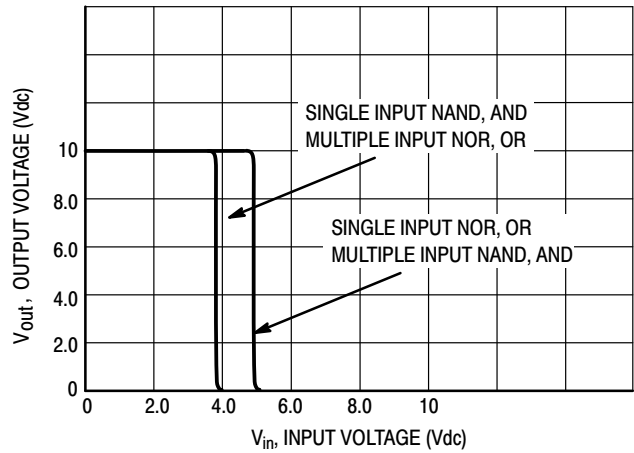

Figure 9. $V_{DD} = 10 \text{ Vdc}$

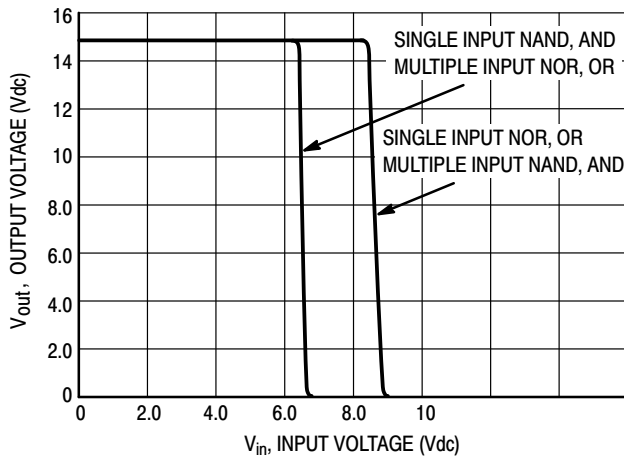

Figure 10. $V_{DD} = 15 \text{ Vdc}$

DC NOISE MARGIN

The DC noise margin is defined as the input voltage range from an ideal “1” or “0” input level which does not produce output state change(s). The typical and guaranteed limit values of the input values V_{IL} and V_{IH} for the output(s) to be at a fixed voltage V_O are given in the Electrical Characteristics table. V_{IL} and V_{IH} are presented graphically in Figure 11.

Guaranteed minimum noise margins for both the “1” and “0” levels =

- 1.0 V with a 5.0 V supply
- 2.0 V with a 10.0 V supply
- 2.5 V with a 15.0 V supply

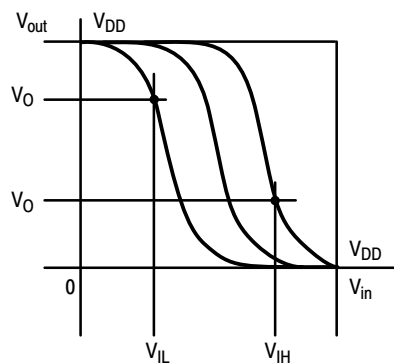

(a) Inverting Function

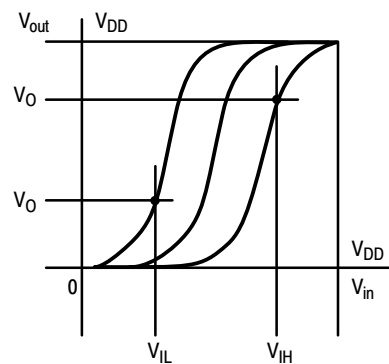

(b) Non-Inverting Function

$V_{SS} = 0 \text{ VOLTS DC}$

Figure 11. DC Noise Immunity

MC14001B Series

ORDERING INFORMATION

Device	Package	Shipping†
MC14001BDG	SOIC-14 (Pb-Free)	55 Units / Rail
NLV14001BDG*		
MC14001BDR2G	SOIC-14 (Pb-Free)	2500 Units / Tape & Reel
NLV14001BDR2G*		
MC14001BDTR2G	TSSOP-14 (Pb-Free)	
NLV14001BDTR2G*		
MC14001BFELG	SOEIAJ-14 (Pb-Free)	2000 Units / Tape & Reel

MC14011BDG	SOIC-14 (Pb-Free)	55 Units / Rail
NLV14011BDG*		
MC14011BDR2G	SOIC-14 (Pb-Free)	2500 Units / Tape & Reel
NLV14011BDR2G*		
MC14011BDTR2G	TSSOP-14 (Pb-Free)	
NLV14011BDTR2G*		
MC14011BFG	SOEIAJ-14 (Pb-Free)	50 Units / Rail
MC14011BFELG		2000 Units / Tape & Reel

MC14023BDG	SOIC-14 (Pb-Free)	55 Units / Rail
MC14023BDR2G	SOIC-14 (Pb-Free)	2500 Units / Tape & Reel
NLV14023BDR2G*		
MC14023BFELG	SOEIAJ-14 (Pb-Free)	2000 Units / Tape & Reel

MC14025BDG	SOIC-14 (Pb-Free)	55 Units / Rail
NLV14025BDG*		
MC14025BDR2G	SOIC-14 (Pb-Free)	2500 Units / Tape & Reel
NLV14025BDR2G*		

MC14071BDG	SOIC-14 (Pb-Free)	55 Units / Rail
NLV14071BDG*		
MC14071BDR2G	SOIC-14 (Pb-Free)	2500 Units / Tape & Reel
NLV14071BDR2G*		
MC14071BDTG	TSSOP-14 (Pb-Free)	96 Units per Rail
MC14071BDTR2G		2500 Units / Tape & Reel
NLV14071BDTR2G*		

MC14073BDG	SOIC-14 (Pb-Free)	55 Units / Rail
MC14073BDR2G	SOIC-14 (Pb-Free)	2500 Units / Tape & Reel

MC14001B Series

ORDERING INFORMATION (continued)

Device	Package	Shipping†
MC14081BDG	SOIC-14 (Pb-Free)	55 Units / Rail
NLV14081BDG*		
MC14081BDR2G	SOIC-14 (Pb-Free)	2500 Units / Tape & Reel
NLV14081BDR2G*		
MC14081BDTR2G	TSSOP-14 (Pb-Free)	
NLV14081BDTR2G*		

MC14082BDG	SOIC-14 (Pb-Free)	55 Units / Rail
NLV14082BDG*		
MC14082BDR2G		2500 Units / Tape & Reel

†For information on tape and reel specifications, including part orientation and tape sizes, please refer to our Tape and Reel Packaging Specifications Brochure, BRD8011/D.

*NLV Prefix for Automotive and Other Applications Requiring Unique Site and Control Change Requirements; AEC-Q100 Qualified and PPAP Capable.

MECHANICAL CASE OUTLINE PACKAGE DIMENSIONS



SCALE 1:1

SOIC-14 NB
CASE 751A-03
ISSUE L

DATE 03 FEB 2016



NOTES:

1. DIMENSIONING AND TOLERANCING PER ASME Y14.5M, 1994.
2. CONTROLLING DIMENSION: MILLIMETERS.
3. DIMENSION b DOES NOT INCLUDE DAMBAR PROTRUSION. ALLOWABLE PROTRUSION SHALL BE 0.13 TOTAL IN EXCESS OF AT MAXIMUM MATERIAL CONDITION.
4. DIMENSIONS D AND E DO NOT INCLUDE MOLD PROTRUSIONS.
5. MAXIMUM MOLD PROTRUSION 0.15 PER SIDE.

DIM	MILLIMETERS		INCHES	
	MIN	MAX	MIN	MAX
A	1.35	1.75	0.054	0.068
A1	0.10	0.25	0.004	0.010
A3	0.19	0.25	0.008	0.010
b	0.35	0.49	0.014	0.019
D	8.55	8.75	0.337	0.344
E	3.80	4.00	0.150	0.157
e	1.27 BSC		0.050 BSC	
H	5.80	6.20	0.228	0.244
h	0.25	0.50	0.010	0.019
L	0.40	1.25	0.016	0.049
M	0°	7°	0°	7°

SOLDERING FOOTPRINT*



DIMENSIONS: MILLIMETERS

*For additional information on our Pb-Free strategy and soldering details, please download the ON Semiconductor Soldering and Mounting Techniques Reference Manual, SOLDERRM/D.

GENERIC MARKING DIAGRAM*



- XXXXXX = Specific Device Code
- A = Assembly Location
- WL = Wafer Lot
- Y = Year
- WW = Work Week
- G = Pb-Free Package

*This information is generic. Please refer to device data sheet for actual part marking. Pb-Free indicator, "G" or microdot "▪", may or may not be present. Some products may not follow the Generic Marking.

STYLES ON PAGE 2

DOCUMENT NUMBER:	98ASB42565B	Electronic versions are uncontrolled except when accessed directly from the Document Repository. Printed versions are uncontrolled except when stamped "CONTROLLED COPY" in red.
DESCRIPTION:	SOIC-14 NB	PAGE 1 OF 2

onsemi and ONSEMI are trademarks of Semiconductor Components Industries, LLC dba onsemi or its subsidiaries in the United States and/or other countries. onsemi reserves the right to make changes without further notice to any products herein. onsemi makes no warranty, representation or guarantee regarding the suitability of its products for any particular purpose, nor does onsemi assume any liability arising out of the application or use of any product or circuit, and specifically disclaims any and all liability, including without limitation special, consequential or incidental damages. onsemi does not convey any license under its patent rights nor the rights of others.

SOIC-14
CASE 751A-03
ISSUE L

DATE 03 FEB 2016

STYLE 1:
 PIN 1. COMMON CATHODE
 2. ANODE/CATHODE
 3. ANODE/CATHODE
 4. NO CONNECTION
 5. ANODE/CATHODE
 6. NO CONNECTION
 7. ANODE/CATHODE
 8. ANODE/CATHODE
 9. ANODE/CATHODE
 10. NO CONNECTION
 11. ANODE/CATHODE
 12. ANODE/CATHODE
 13. NO CONNECTION
 14. COMMON ANODE

STYLE 2:
 CANCELLED

STYLE 3:
 PIN 1. NO CONNECTION
 2. ANODE
 3. ANODE
 4. NO CONNECTION
 5. ANODE
 6. NO CONNECTION
 7. ANODE
 8. ANODE
 9. ANODE
 10. NO CONNECTION
 11. ANODE
 12. ANODE
 13. NO CONNECTION
 14. COMMON CATHODE

STYLE 4:
 PIN 1. NO CONNECTION
 2. CATHODE
 3. CATHODE
 4. NO CONNECTION
 5. CATHODE
 6. NO CONNECTION
 7. CATHODE
 8. CATHODE
 9. CATHODE
 10. NO CONNECTION
 11. CATHODE
 12. CATHODE
 13. NO CONNECTION
 14. COMMON ANODE

STYLE 5:
 PIN 1. COMMON CATHODE
 2. ANODE/CATHODE
 3. ANODE/CATHODE
 4. ANODE/CATHODE
 5. ANODE/CATHODE
 6. NO CONNECTION
 7. COMMON ANODE
 8. COMMON CATHODE
 9. ANODE/CATHODE
 10. ANODE/CATHODE
 11. ANODE/CATHODE
 12. ANODE/CATHODE
 13. NO CONNECTION
 14. COMMON ANODE

STYLE 6:
 PIN 1. CATHODE
 2. CATHODE
 3. CATHODE
 4. CATHODE
 5. CATHODE
 6. CATHODE
 7. CATHODE
 8. ANODE
 9. ANODE
 10. ANODE
 11. ANODE
 12. ANODE
 13. ANODE
 14. ANODE

STYLE 7:
 PIN 1. ANODE/CATHODE
 2. COMMON ANODE
 3. COMMON CATHODE
 4. ANODE/CATHODE
 5. ANODE/CATHODE
 6. ANODE/CATHODE
 7. ANODE/CATHODE
 8. ANODE/CATHODE
 9. ANODE/CATHODE
 10. ANODE/CATHODE
 11. COMMON CATHODE
 12. COMMON ANODE
 13. ANODE/CATHODE
 14. ANODE/CATHODE

STYLE 8:
 PIN 1. COMMON CATHODE
 2. ANODE/CATHODE
 3. ANODE/CATHODE
 4. NO CONNECTION
 5. ANODE/CATHODE
 6. ANODE/CATHODE
 7. COMMON ANODE
 8. COMMON ANODE
 9. ANODE/CATHODE
 10. ANODE/CATHODE
 11. NO CONNECTION
 12. ANODE/CATHODE
 13. ANODE/CATHODE
 14. COMMON CATHODE

DOCUMENT NUMBER:	98ASB42565B	Electronic versions are uncontrolled except when accessed directly from the Document Repository. Printed versions are uncontrolled except when stamped "CONTROLLED COPY" in red.
DESCRIPTION:	SOIC-14 NB	PAGE 2 OF 2

onsemi and **ONSEMI** are trademarks of Semiconductor Components Industries, LLC dba **onsemi** or its subsidiaries in the United States and/or other countries. **onsemi** reserves the right to make changes without further notice to any products herein. **onsemi** makes no warranty, representation or guarantee regarding the suitability of its products for any particular purpose, nor does **onsemi** assume any liability arising out of the application or use of any product or circuit, and specifically disclaims any and all liability, including without limitation special, consequential or incidental damages. **onsemi** does not convey any license under its patent rights nor the rights of others.

MECHANICAL CASE OUTLINE PACKAGE DIMENSIONS

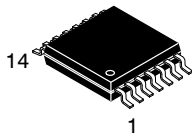

TSSOP-14 WB
CASE 948G
ISSUE C

DATE 17 FEB 2016

SCALE 2:1



NOTES:

1. DIMENSIONING AND TOLERANCING PER ANSI Y14.5M, 1982.
2. CONTROLLING DIMENSION: MILLIMETER.
3. DIMENSION A DOES NOT INCLUDE MOLD FLASH, PROTRUSIONS OR GATE BURRS. MOLD FLASH OR GATE BURRS SHALL NOT EXCEED 0.15 (0.006) PER SIDE.
4. DIMENSION B DOES NOT INCLUDE INTERLEAD FLASH OR PROTRUSION. INTERLEAD FLASH OR PROTRUSION SHALL NOT EXCEED 0.25 (0.010) PER SIDE.
5. DIMENSION K DOES NOT INCLUDE DAMBAR PROTRUSION. ALLOWABLE DAMBAR PROTRUSION SHALL BE 0.08 (0.003) TOTAL IN EXCESS OF THE K DIMENSION AT MAXIMUM MATERIAL CONDITION.
6. TERMINAL NUMBERS ARE SHOWN FOR REFERENCE ONLY.
7. DIMENSION A AND B ARE TO BE DETERMINED AT DATUM PLANE -W-.

DIM	MILLIMETERS		INCHES	
	MIN	MAX	MIN	MAX
A	4.90	5.10	0.193	0.200
B	4.30	4.50	0.169	0.177
C	---	1.20	---	0.047
D	0.05	0.15	0.002	0.006
F	0.50	0.75	0.020	0.030
G	0.65 BSC		0.026 BSC	
H	0.50	0.60	0.020	0.024
J	0.09	0.20	0.004	0.008
J1	0.09	0.16	0.004	0.006
K	0.19	0.30	0.007	0.012
K1	0.19	0.25	0.007	0.010
L	6.40 BSC		0.252 BSC	
M	0°	8°	0°	8°

GENERIC MARKING DIAGRAM*



- A = Assembly Location
- L = Wafer Lot
- Y = Year
- W = Work Week
- = Pb-Free Package

(Note: Microdot may be in either location)

*This information is generic. Please refer to device data sheet for actual part marking. Pb-Free indicator, "G" or microdot "▪", may or may not be present. Some products may not follow the Generic Marking.

SOLDERING FOOTPRINT

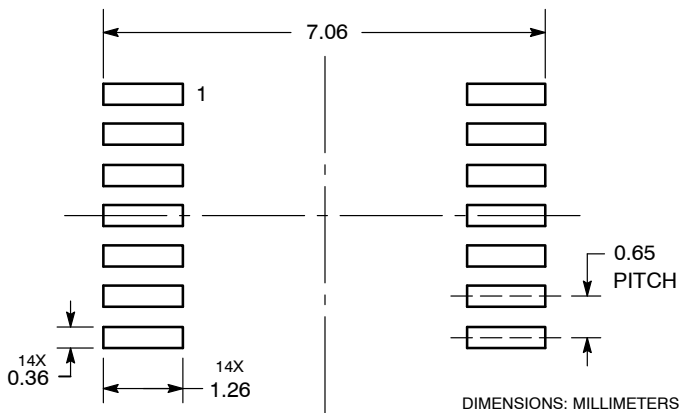

DOCUMENT NUMBER:	98ASH70246A	Electronic versions are uncontrolled except when accessed directly from the Document Repository. Printed versions are uncontrolled except when stamped "CONTROLLED COPY" in red.
DESCRIPTION:	TSSOP-14 WB	PAGE 1 OF 1

onsemi and onsemi are trademarks of Semiconductor Components Industries, LLC dba onsemi or its subsidiaries in the United States and/or other countries. onsemi reserves the right to make changes without further notice to any products herein. onsemi makes no warranty, representation or guarantee regarding the suitability of its products for any particular purpose, nor does onsemi assume any liability arising out of the application or use of any product or circuit, and specifically disclaims any and all liability, including without limitation special, consequential or incidental damages. onsemi does not convey any license under its patent rights nor the rights of others.

onsemi, **Onsemi**, and other names, marks, and brands are registered and/or common law trademarks of Semiconductor Components Industries, LLC dba "**onsemi**" or its affiliates and/or subsidiaries in the United States and/or other countries. **onsemi** owns the rights to a number of patents, trademarks, copyrights, trade secrets, and other intellectual property. A listing of **onsemi**'s product/patent coverage may be accessed at www.onsemi.com/site/pdf/Patent-Marking.pdf. **onsemi** reserves the right to make changes at any time to any products or information herein, without notice. The information herein is provided "as-is" and **onsemi** makes no warranty, representation or guarantee regarding the accuracy of the information, product features, availability, functionality, or suitability of its products for any particular purpose, nor does **onsemi** assume any liability arising out of the application or use of any product or circuit, and specifically disclaims any and all liability, including without limitation special, consequential or incidental damages. Buyer is responsible for its products and applications using **onsemi** products, including compliance with all laws, regulations and safety requirements or standards, regardless of any support or applications information provided by **onsemi**. "Typical" parameters which may be provided in **onsemi** data sheets and/or specifications can and do vary in different applications and actual performance may vary over time. All operating parameters, including "Typicals" must be validated for each customer application by customer's technical experts. **onsemi** does not convey any license under any of its intellectual property rights nor the rights of others. **onsemi** products are not designed, intended, or authorized for use as a critical component in life support systems or any FDA Class 3 medical devices or medical devices with a same or similar classification in a foreign jurisdiction or any devices intended for implantation in the human body. Should Buyer purchase or use **onsemi** products for any such unintended or unauthorized application, Buyer shall indemnify and hold **onsemi** and its officers, employees, subsidiaries, affiliates, and distributors harmless against all claims, costs, damages, and expenses, and reasonable attorney fees arising out of, directly or indirectly, any claim of personal injury or death associated with such unintended or unauthorized use, even if such claim alleges that **onsemi** was negligent regarding the design or manufacture of the part. **onsemi** is an Equal Opportunity/Affirmative Action Employer. This literature is subject to all applicable copyright laws and is not for resale in any manner.

ADDITIONAL INFORMATION

TECHNICAL PUBLICATIONS:

Technical Library: www.onsemi.com/design/resources/technical-documentation
onsemi Website: www.onsemi.com

ONLINE SUPPORT: www.onsemi.com/support

For additional information, please contact your local Sales Representative at www.onsemi.com/support/sales

