

## DS55113/DS75113 Dual TRI-STATE® Differential Line Driver

### General Description

The DS55113/DS75113 dual differential line drivers with TRI-STATE outputs are designed to provide all the features of the DS55114/DS75114 line drivers with the added feature of driver output controls. There are individual controls for each output pair, as well as a common control for both output pairs. When an output control is low, the associated output is in a high-impedance state and the output can neither drive nor load the bus. This permits many devices to be connected together on the same transmission line for party-line applications.

The output stages are similar to TTL totem-pole outputs, but with the sink outputs, YS and ZS, and the corresponding active pull-up terminals, YP and ZP, available on adjacent package pins.

### Features

- Each circuit offers a choice of open-collector or active pull-up (totem-pole) outputs
- Single 5V supply
- Differential line operation
- Dual channels
- TTL/LS compatibility
- High-impedance output state for party-line applications
- Short-circuit protection
- High current outputs
- Single-ended or differential AND/NAND outputs
- Common and individual output controls
- Clamp diodes at inputs
- Easily adaptable to DS55114/DS75114 applications

### Connection Diagram

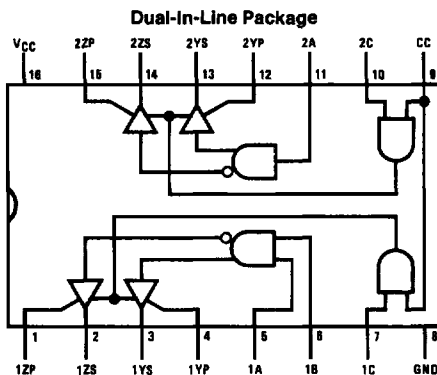

Positive logic:  $Y = AB$   
 $Z = \overline{AB}$

Output is OFF when  
C or CC is low

TL/F/5785-1

Top View

Order Number DS55113J, DS75113M or DS75113N  
See NS Package Number J16A, M16A or N16A

For Complete Military 883 Specifications, see RETS Datasheet.

Order Number DS55113J/883  
See NS Package Number J16A

### Truth Table

Inputs				Outputs	
Output Control		Data		AND	NAND
C	CC	A	B*	Y	Z
L	X	X	X	Z	Z
X	L	X	X	Z	Z
H	H	L	X	L	H*
H	H	X	L	L	H
H	H	H	H	H	L

H = high level  
L = low level  
X = irrelevant  
Z = high impedance (OFF)  
\*B input and 4th line of truth table applicable only to driver number 1

**Absolute Maximum Ratings** (Note 1)

If Military/Aerospace specified devices are required, please contact the National Semiconductor Sales Office/Distributors for availability and specifications.

Supply Voltage ( $V_{CC}$ ) (Note 1) 7V

Input Voltage 5.5V

OFF-State Voltage Applied to Open-Collector Outputs 12V

Maximum Power Dissipation\* at 25°C

Cavity Package 1433 mW

Molded DIP Package 1362 mW

SO Package 1002 mW

Operating Free-Air Temperature Range

DS55113 -55°C to +125°C

DS75113 0°C to +70°C

\*Derate cavity package 9.6 mW/°C above 25°C; derate molded DIP package 10.9 mW/°C above 25°C; derate SO package 8.01 mW/°C above 25°C (Note 2).

Storage Temperature Range -65°C to +150°C

Lead Temperature (1/16" from case for 60 seconds): J Package 300°C

Lead Temperature (1/16" from case for 4 seconds): N Package 260°C

**Operating Conditions**

	Min	Max	Units
Supply Voltage ( $V_{CC}$ )			
DS55113	4.5	5.5	V
DS75113	4.75	5.25	V
High Level Output Current ( $I_{OH}$ )		-40	mA
Low Level Output Current ( $I_{OL}$ )		40	mA
Operating Free-Air Temperature ( $T_A$ )			
DS55113	-55	125	°C
DS75113	0	70	°C

**Electrical Characteristics** Over recommended operating free-air temperature range (unless otherwise noted)

Symbol	Parameter	Conditions (Note 3)	DS55113			DS75113			Units		
			Min	Typ (Note 4)	Max	Min	Typ (Note 4)	Max			
$V_{IH}$	High Level Input Voltage		2			2			V		
$V_{IL}$	Low Level Input Voltage				0.8			0.8	V		
$V_{IK}$	Input Clamp Voltage	$V_{CC} = \text{Min}, I_I = -12 \text{ mA}$		-0.9	-1.5		-0.9	-1.5	V		
$V_{OH}$	High Level Output Voltage	$V_{CC} = \text{Min}, V_{IH} = 2V, V_{IL} = 0.8V$		$I_{OH} = -10 \text{ mA}$	2.4	3.4		2.4	3.4	V	
				$I_{OH} = -40 \text{ mA}$	2	3.0		2	3.0		
$V_{OL}$	Low Level Output Voltage	$V_{CC} = \text{Min}, V_{IH} = 2V, V_{IL} = 0.8V, I_{OL} = 40 \text{ mA}$		0.23	0.4		0.23	0.4	V		
$V_{OK}$	Output Clamp Voltage	$V_{CC} = \text{Max}, I_O = -40 \text{ mA}$		-1.1	-1.5		-1.1	-1.5	V		
$I_{O(\text{off})}$	Off-State Open-Collector Output Current	$V_{CC} = \text{Max}$	$V_{OH} = 12V$	$T_A = 25^\circ\text{C}$	1	10				$\mu\text{A}$	
				$T_A = 125^\circ\text{C}$			200				
			$V_{OH} = 5.25V$	$T_A = 25^\circ\text{C}$				1	10		
				$T_A = 70^\circ\text{C}$					20		
$I_{OZ}$	Off-State (High-Impedance-State) Output Current	$V_{CC} = \text{Max},$ Output Controls at 0.8V	$T_A = 25^\circ\text{C}, V_O = 0 \text{ to } V_{CC}$	$T_A = \text{Max}$	$V_O = 0V$			$\pm 10$		$\pm 10$	$\mu\text{A}$
					$V_O = 0.4V$			$\pm 80$		$\pm 20$	
					$V_O = 2.4V$			$\pm 80$		$\pm 20$	
					$V_O = V_{CC}$			80		20	
$I_I$	Input Current at Maximum Input Voltage	A, B, C CC	$V_{CC} = \text{Max}, V_I = 5.5V$				1		1	mA	
							2		2		
$I_{IH}$	High Level Input Current	A, B, C CC	$V_{CC} = \text{Max}, V_I = 2.4V$				40		40	$\mu\text{A}$	
							80		80		
$I_{IL}$	Low Level Input Current	A, B, C CC	$V_{CC} = \text{Max}, V_I = 0.4V$				-1.6		-1.6	mA	
							-3.2		-3.2		

7

## Electrical Characteristics

Over recommended operating free-air temperature range (unless otherwise noted) (Continued)

Symbol	Parameter	Conditions (Note 3)	DS55113			DS75113			Units
			Min	Typ (Note 4)	Max	Min	Typ (Note 4)	Max	
I <sub>OS</sub>	Short-Circuit Output Current (Note 5)	V <sub>CC</sub> = Max, V <sub>O</sub> = 0V	-40	-90	-120	-40	-90	-120	mA
I <sub>CC</sub>	Supply Current (Both Drivers)	All Inputs at 0V, No Load T <sub>A</sub> = 25°C	V <sub>CC</sub> = Max	47	65		47	65	mA
			V <sub>CC</sub> = 7V	65	85		65	85	

**Note 1:** All voltage values are with respect to network ground terminal.

**Note 2:** For operation above 25°C free-air temperature, refer to Dissipation Derating Curves in the Thermal information section.

**Note 3:** All parameters with the exception of OFF-state open-collector output current are measured with the active pull-up connected to the sink output.

**Note 4:** All typical values are at T<sub>A</sub> = 25°C and V<sub>CC</sub> = 5V, with the exception of I<sub>CC</sub> at 7V.

**Note 5:** Only one output should be shorted at a time, and duration of the short-circuit should not exceed one second.

## Switching Characteristics V<sub>CC</sub> = 5V, C<sub>L</sub> = 30 pF, T<sub>A</sub> = 25°C

Symbol	Parameter	Conditions	DS55113			DS75113			Unit
			Min	Typ	Max	Min	Typ	Max	
t <sub>PLH</sub>	Propagation Delay Time, Low-to-High-Level Output	(Figure 1)		13	20		13	30	ns
t <sub>PHL</sub>	Propagation Delay Time, High-to-Low-Level Output			12	20		12	30	ns
t <sub>PZH</sub>	Output Enable Time to High Level	R <sub>L</sub> = 180Ω, (Figure 2)		7	15		7	20	ns
t <sub>PZL</sub>	Output Enable Time to Low Level	R <sub>L</sub> = 250Ω, (Figure 3)		14	30		14	40	ns
t <sub>PHZ</sub>	Output Disable Time from High Level	R <sub>L</sub> = 180Ω, (Figure 2)		10	20		10	30	ns
t <sub>PLZ</sub>	Output Disable Time from Low Level	R <sub>L</sub> = 250Ω, (Figure 3)		17	35		17	35	ns



# AC Test Circuits and Switching Time Waveforms

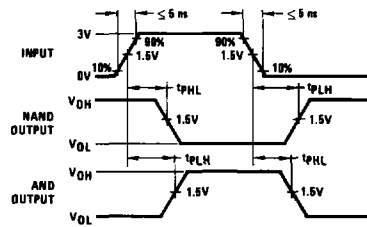
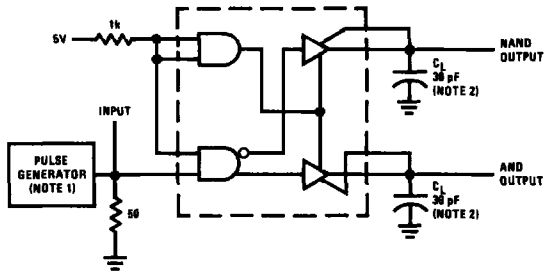

FIGURE 1.  $t_{pLH}$  and  $t_{pHL}$

TL/F/5785-3

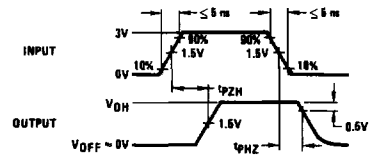
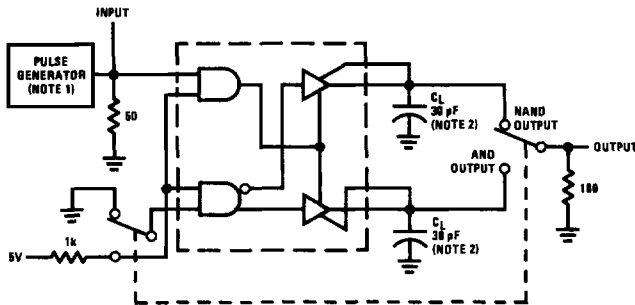

FIGURE 2.  $t_{pZH}$  and  $t_{pHZ}$

TL/F/5785-4

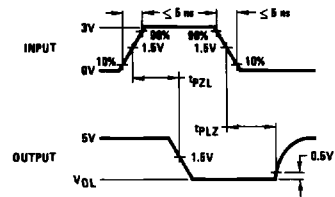
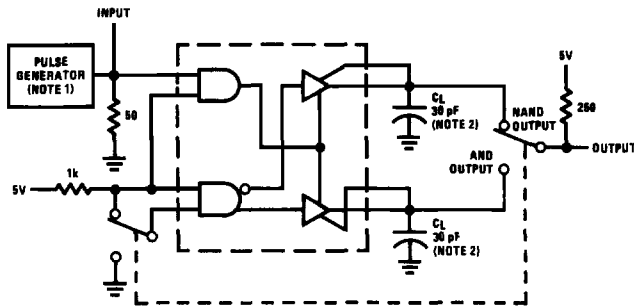

FIGURE 3.  $t_{pZL}$  and  $t_{pLZ}$

TL/F/5785-5

**Note 1:** The pulse generator has the following characteristics:  $Z_{OUT} = 50\Omega$ , PRR = 500 kHz,  $t_W = 100$  ns.

**Note 2:**  $C_L$  includes probe and jig capacitance.

# Typical Performance Characteristics\*

### Output Voltage vs Output Control Voltage

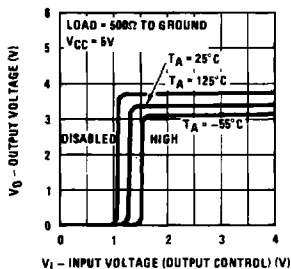

### Output Voltage vs Output Control Voltage

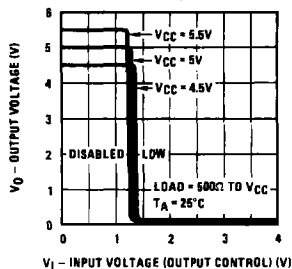

### Output Voltage vs Output Control Voltage

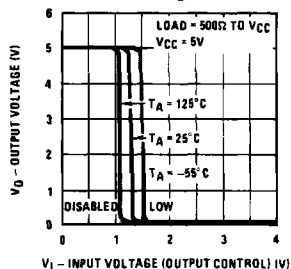

### Output Voltage vs Free-Air Temperature

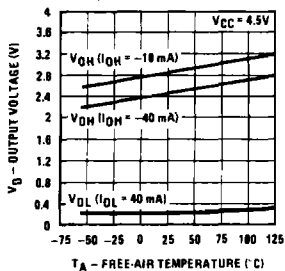

### High Level Output Voltage vs Output Current

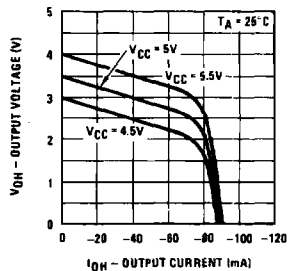

### Low Level Output Voltage vs Output Current

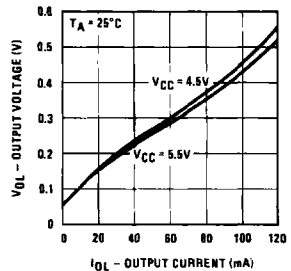

### Supply Current (Both Drivers) vs Supply Voltage

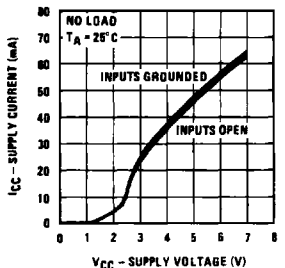

### Supply Current (Both Drivers) vs Free-Air Temperature

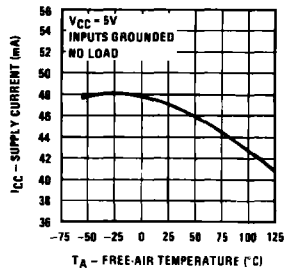

### Supply Current (Both Drivers) vs Frequency

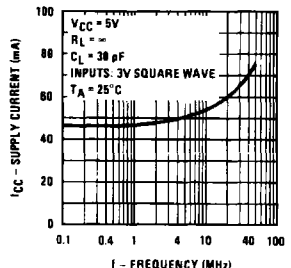

### Propagation Delay Times from Data Inputs vs Free-Air Temperature

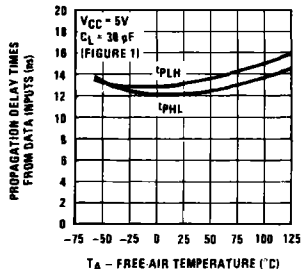

### Output Enable and Disable Times vs Free-Air Temperature

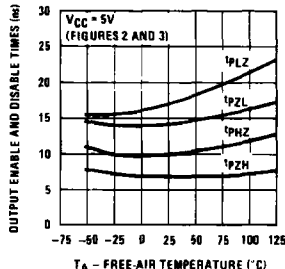

\*Data for temperatures below 0°C and above 70°C and for supply voltages below 4.75V and above 5.25V are applicable to DS55113 circuits only. These parameters were measured with the active pull-up connected to the sink output.

## Typical Performance Characteristics\* (Continued)

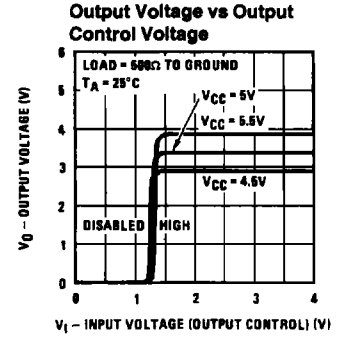
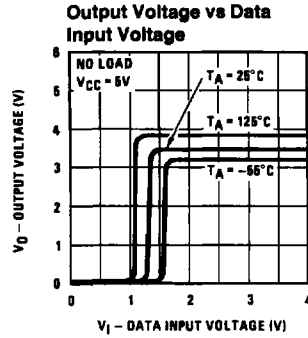
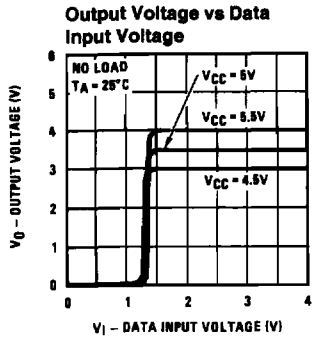

TL/F/5785-6

\*Data for temperatures below 0°C and above 70°C and for supply voltages below 4.75V and above 5.25V are applicable to DS55113 circuits only. These parameters were measured with the active pull-up connected to the sink output.