

1. Description

KNX6180B is an N-channel enhancement mode power MOS field effect transistor which is produced using KIA proprietary F-Cell™ high-voltage planar VDMOS technology. The improved process and cell structure have been especially tailored to minimize on-state resistance, provide superior switching performance, and withstand high energy pulse in the avalanche and commutation mode.

These devices are widely used in AC-DC power supplies, DC-DC converters and H-bridge PWM motor drivers.

2. Features

- 10A,800V, $R_{DS(ON)(typ.)}=0.87\Omega @ V_{GS}=10V$
- Low Gate Charge
- Low Crss
- Fast switching
- Improved dv/dt capability

3. Pin configuration

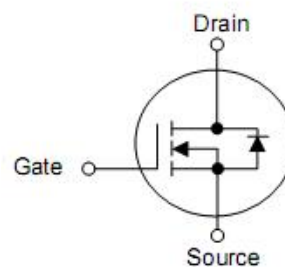
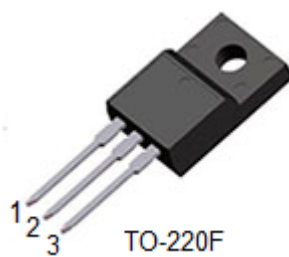

Pin	Function
1	Gate
2	Drain
3	Source

4. Ordering Information

Part Number	Package	Brand
KNF6180B	TO-220F	KIA

5. Absolute maximum ratings

$T_C=25^\circ\text{C}$ unless otherwise specified

Parameter	Symbol	Ratings	Unit
Drain-Source Voltage	V_{DSS}	800	V
Gate-Source Voltage	V_{GSS}	± 30	V
Continuous Drain Current	I_D	$T_C=25^\circ\text{C}$	10
		$T_C=100^\circ\text{C}$	6.32
Pulsed Drain Current at $V_{GS}=10\text{V}$	I_{DM}	40	A
Power Dissipation ($T_C=25^\circ\text{C}$)	P_D	62	W
Derating Factor above 25°C		0.5	W/ $^\circ\text{C}$
Single Pulsed Avalanche Energy ¹⁾	EAS	938	mJ
Reverse Diode dv/dt ²⁾	dv/dt	4.5	V/ns
MOSFET dv/dt Ruggedness ³⁾	dv/dt	50	V/ns
Operation Junction Temperature Range	T_J	-55 to 150	$^\circ\text{C}$
Storage Temperature Range	T_{STG}	-55 to 150	$^\circ\text{C}$

6. Thermal characteristics

Parameter	Symbol	Ratings	Unit
Thermal Resistance, Junction-to-Case	$R_{\theta JC}$	2.02	$^\circ\text{C/W}$
Thermal Resistance, Junction-to-Ambient	$R_{\theta JA}$	62.5	$^\circ\text{C/W}$

7. Electrical characteristics

 (T_c=25°C, unless otherwise notes)

Parameter	Symbol	Conditions	Min	Typ	Max	Units
Drain-to-Source Breakdown Voltage	BV _{DSS}	V _{GS} =0V, I _D =250uA	800	-	-	V
Drain-to-Source Leakage Current	I _{DSS}	V _{DS} =800V, V _{GS} =0V	-	-	1	uA
Gate-to-Source Leakage Current	I _{GSS}	V _{GS} =±30V, V _{DS} =0V	-	-	±100	nA
Gate Threshold Voltage	V _{GS(TH)}	V _{DS} =V _{GS} , I _D =250uA	2.0	-	4.0	V
Static Drain-to-Source On-Resistance	R _{DS(ON)}	V _{GS} =10V, I _D =5.0A	-	0.87	1.05	mΩ
Gate Resistance	R _g	F=1MHz	-	16	-	Ω
Input Capacitance	C _{iss}	V _{GS} =0V, V _{DS} =25V F=1.0MHz	-	1625	-	pF
Output Capacitance	C _{oss}		-	152	-	pF
Reverse Transfer Capacitance	C _{rss}		-	6.4	-	pF
Turn-on Delay Time	t _{d(on)}	V _{DD} =400V, R _G =25Ω, I _D =10A ^{4), 5)}	-	28	-	nS
Rise Time	t _r		-	42	-	nS
Turn-Off Delay Time	t _{d(off)}		-	90	-	nS
Fall Time	t _f		-	75	-	nS
Total Gate Charge	Q _g	V _{DS} =640V, V _{GS} =10V, I _D =10A ^{4), 5)}	-	32	-	nC
Gate-to-Source Charge	Q _{gs}		-	8.5	-	nC
Gate-to-Drain (Miller) Charge	Q _{gd}		-	12	-	nC
Continuous Source Current	I _S	Integral Reverse P-N Junction Diode in the MOSFET	-	-	10	A
Pulsed Source Current	I _{SM}		-	-	40	A
Diode Forward Voltage	V _{SD}	I _S =10A, V _{GS} =0V	-	-	1.4	V
Reverse Recovery Time	t _{rr}	I _S =10A, V _{GS} =0V, dI _F /dt=100A/us ⁴⁾	-	611	-	ns
Reverse Recovery Charge	Q _{rr}		-	5.6	-	nC

Notes:

- L=30mH, I_{AS}=7.5A, V_{DD}=100V, R_G=25Ω, starting T_J=25°C;
- V_{DS}=0~400V, I_{SD}≤10A, T_J=25°C;
- V_{DS}=0~480V
- Pulse Test: Pulse width≤300us, Duty cycle≤2%;
- Essentially independent of operating temperature.

8. Typical Characteristics

Figure 1. On-Region Characteristics

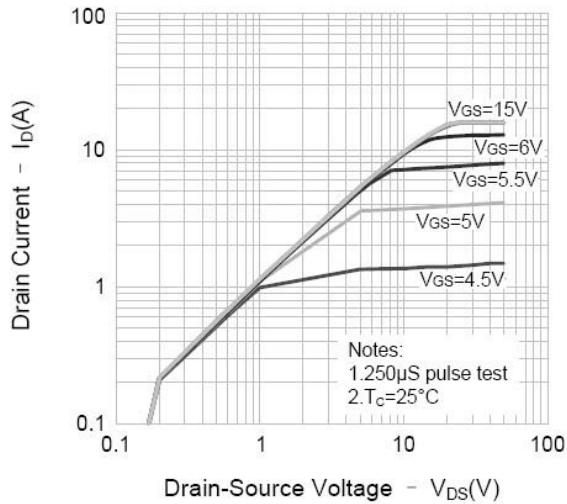

Figure 2. Transfer Characteristics

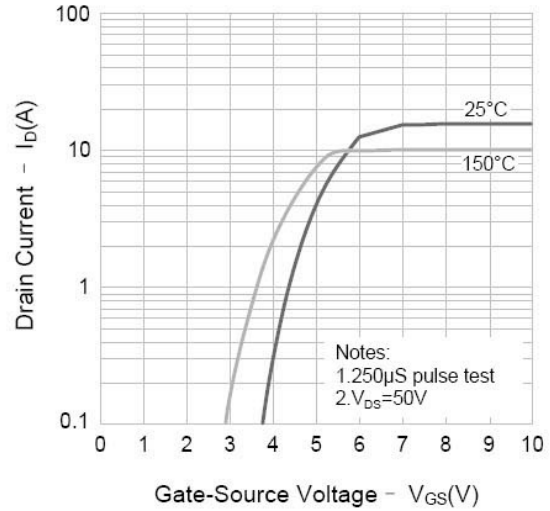

Figure 3. On-Resistance Variation vs. Drain Current and Gate Voltage

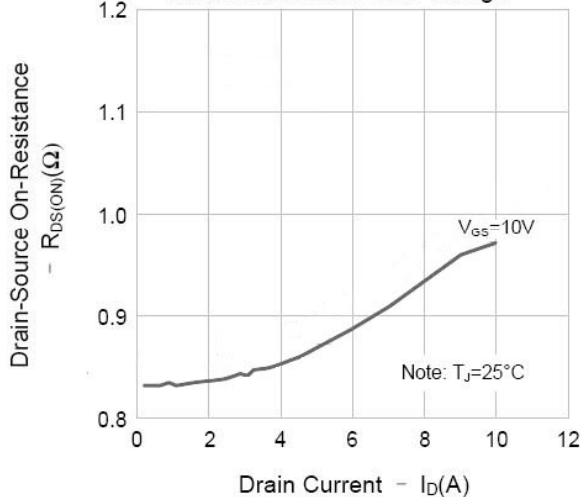

Figure 4. Body Diode Forward Voltage Variation vs. Source Current and Temperature

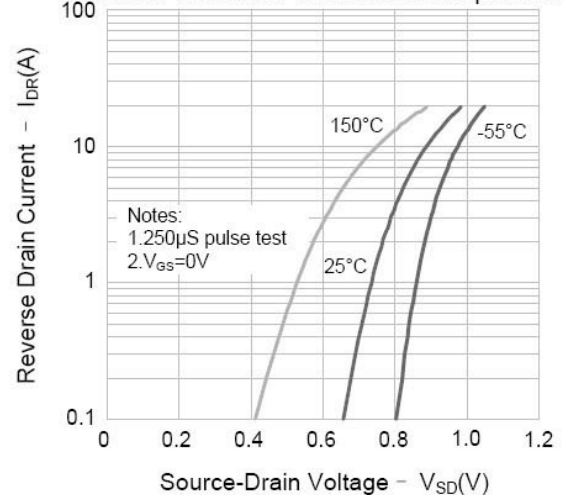

Figure 5. Capacitance Characteristics

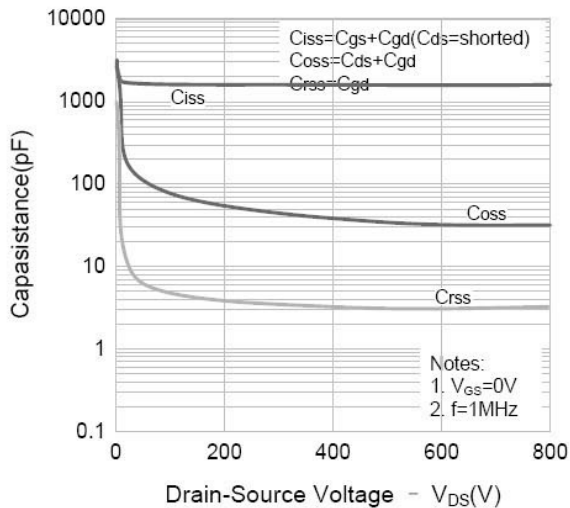

Figure 6. Gate Charge Characteristics

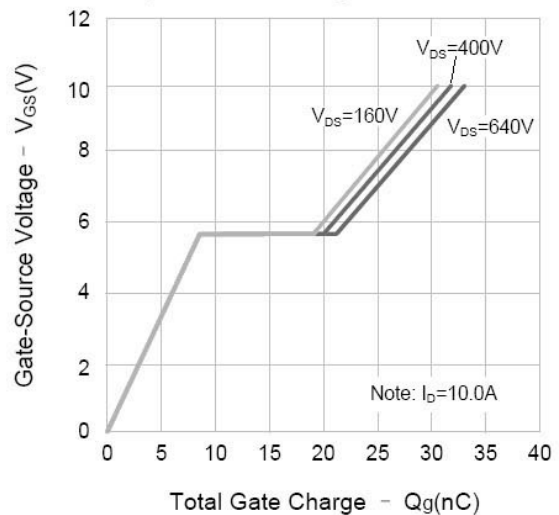

Figure 7. Breakdown Voltage Variation vs. Temperature

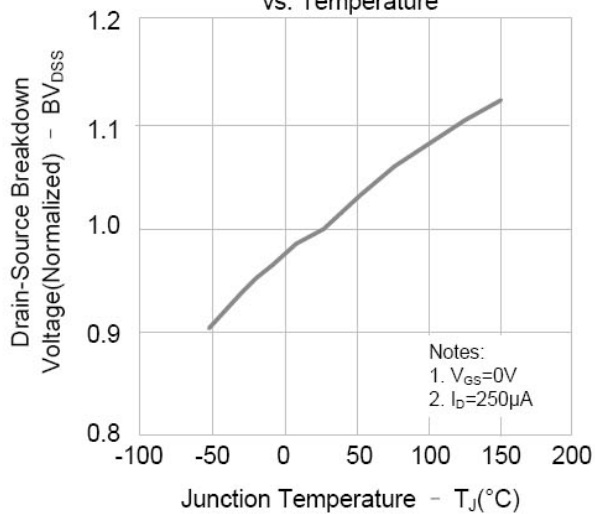

Figure 8. On-resistance Variation vs. Temperature

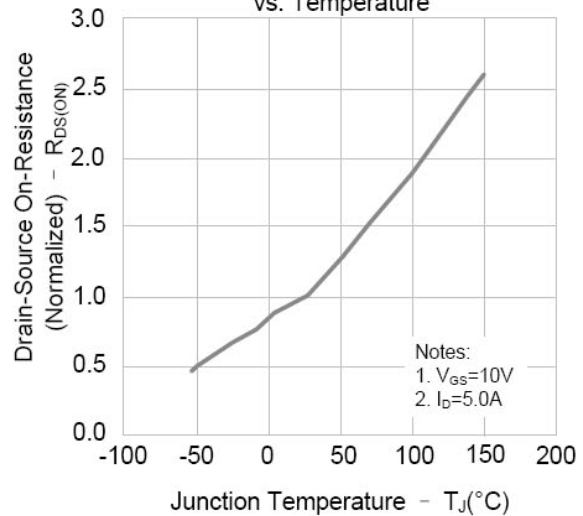

Figure 9-1. Max. Safe Operating Area(SVF10N80F)

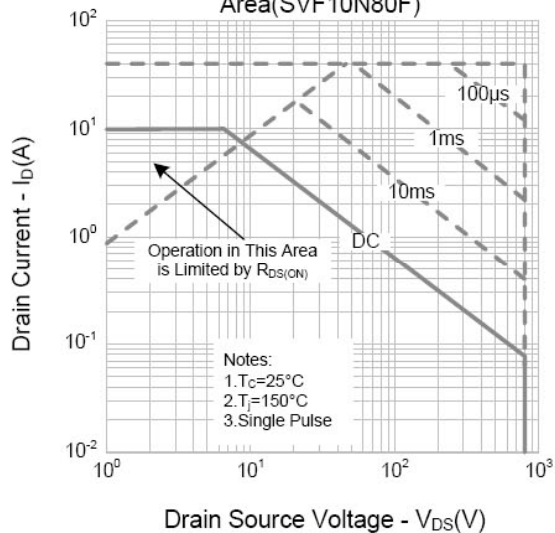

Figure 9-2. Max. Safe Operating Area (SVF10N80K)

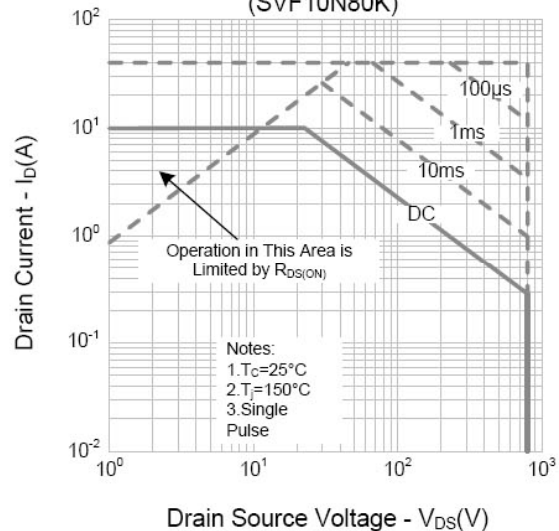
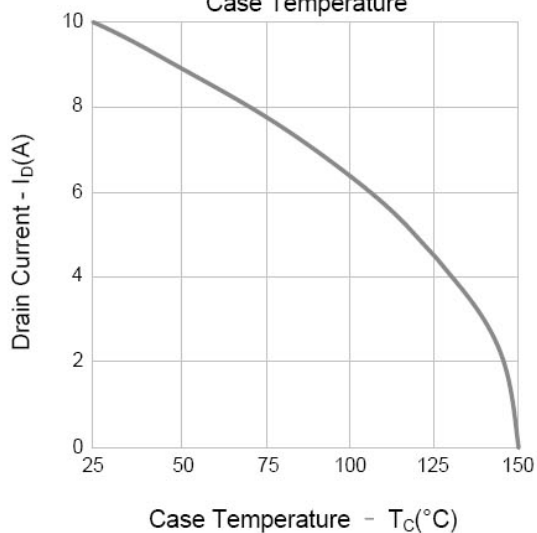
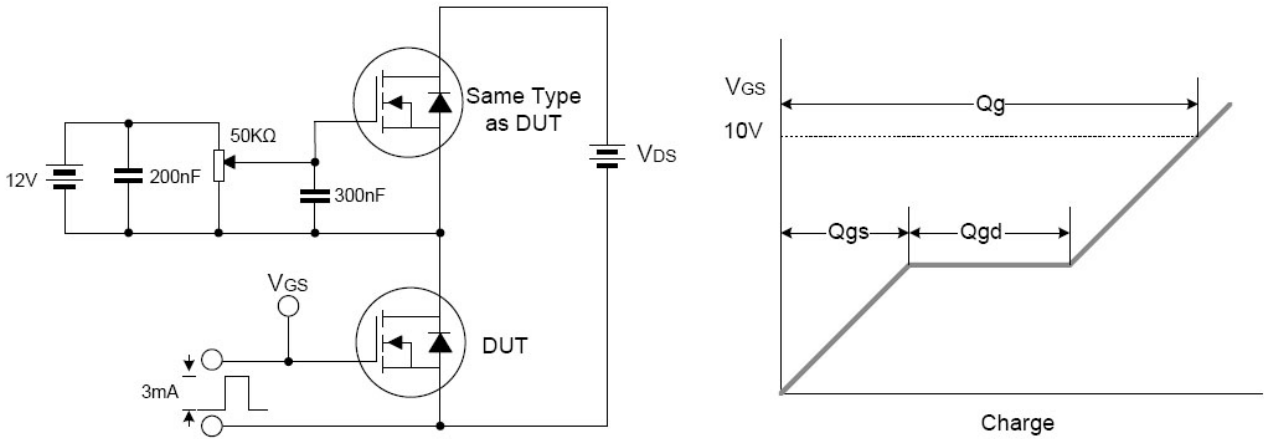

Figure 10. Maximum Drain Current vs. Case Temperature



9. Test Circuits and Waveforms

Gate Charge Test Circuit & Waveform



Resistive Switching Test Circuit & Waveform

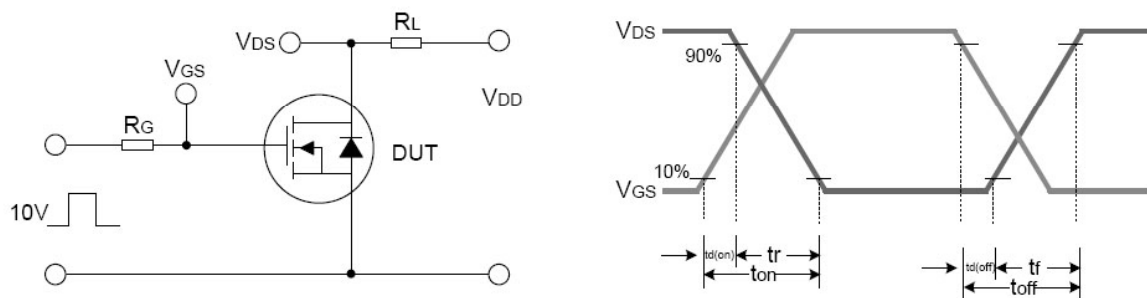

Unclamped Inductive Switching Test Circuit & Waveform

