

SN65C189, SN65C189A, SN75C189, SN75C189A QUADRUPLE LOW-POWER LINE RECEIVERS

SLLS041D – OCTOBER 1988 – REVISED MAY 1995

- Meets or Exceeds the Requirements of ANSI EIA/TIA-232-E and ITU Recommendation V.28
- Low Supply Current . . . 420 μ A Typ
- Preset On-Chip Input Noise Filter
- Built-in Input Hysteresis
- Response and Threshold Control Inputs
- Push-Pull Outputs
- Functionally Interchangeable and Pin Compatible With Texas Instruments SN75189/SN75189A, Motorola MC1489/MC1489A, and National Semiconductor DS14C88A

description

The SN65C189, SN65C189A, SN75C189, and SN75C189A are low-power bipolar quadruple line receivers that are used to interface data terminal equipment (DTE) with data circuit-terminating equipment (DCE). These devices have been designed to conform with ANSI Standard EIA/TIA-232-E.

The SN65C189 and SN75C189 have a 0.33 V typical hysteresis compared with 0.97 V for the SN65C189A and SN75C189A. Each receiver has provision for adjustment of the overall input threshold levels. This is achieved by choosing external series resistors and voltages to provide bias levels for the response control pins. The output is in the high logic state if the input is left open circuited or shorted to ground.

These devices have an on-chip filter that rejects input pulses of shorter than 1- μ s minimum duration. An external capacitor may be connected from the control pins to ground to provide further input noise filtering for each receiver.

The SN65C189, SN75C189, SN65C189A, and SN75C189A have been designed using low-power techniques in a bipolar technology. In most applications, these receivers will interface to single inputs of peripheral devices such as UARTs, ACEs, or microprocessors. By using sampling, such peripheral devices are usually insensitive to the transition times of the input signals. If this is not the case or for other uses, it is recommended that the SN65C189, SN75C189, SN65C189A, and SN75C189A outputs be buffered by single Schmitt input gates or single gates of the HCMOS, ALS, or 74F logic families.

The SN65C189 and SN65C189A are characterized for operation from -40°C to 85°C . The SN75C189 and SN75C189A are characterized for operation from 0°C to 70°C .

D, DB†, N, OR NS† PACKAGE
(TOP VIEW)

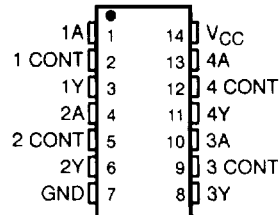

† The DB and NS packages are only available left-end taped and reeled, i.e., order SN75C189ADBLE or SN75C189ANSLE.

logic symbol†

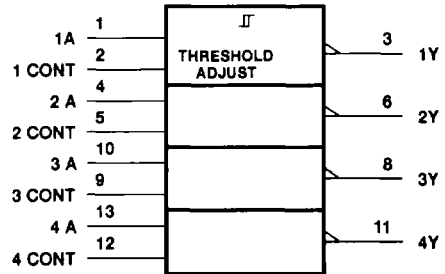

† This symbol is in accordance with ANSI/IEEE Std 91-1984 and IEC Publication 617-12.

logic diagram (each receiver)

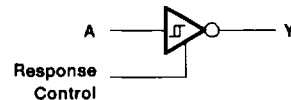

PRODUCTION DATA Information is current as of publication date. Products conform to specifications per the terms of Texas Instruments standard warranty. Production processing does not necessarily include testing of all parameters.

 **TEXAS
INSTRUMENTS**

POST OFFICE BOX 655303 • DALLAS, TEXAS 75265

Copyright © 1995, Texas Instruments Incorporated

2-733

SN65C189, SN65C189A, SN75C189, SN75C189A QUADRUPLE LOW-POWER LINE RECEIVERS

SLLS041D – OCTOBER 1988 – REVISED MAY 1995

schematic of inputs and outputs

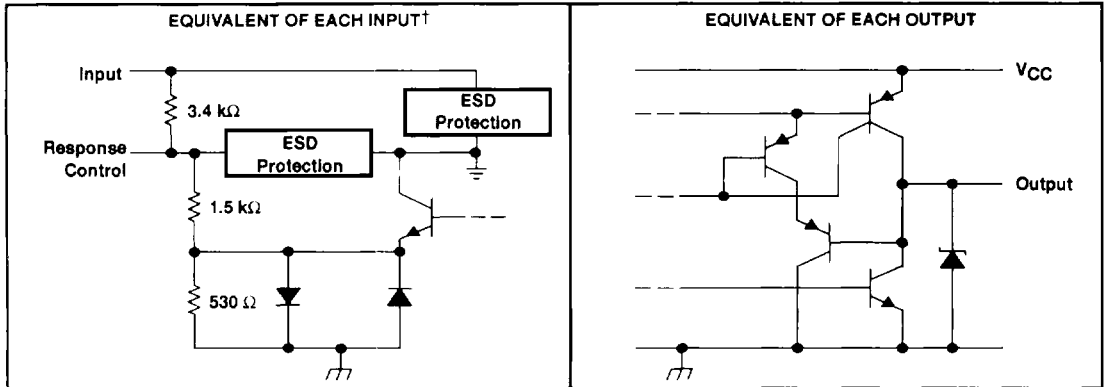

† All resistor values shown are nominal.

absolute maximum ratings over operating free-air temperature range (unless otherwise noted)†

Supply voltage, V _{CC} (see Note 1)	7 V
Input voltage range, V _I	-30 V to 30 V
Output voltage range, V _O	-0.3 V to V _{CC} + 0.3 V
Continuous total dissipation	See Dissipation Rating Table
Operating free-air temperature range, T _A : SN65C189, SN65C189A	-40°C to 85°C
SN75C189, SN75C189A	0°C to 70°C
Storage temperature range, T _{stg}	-65°C to 150°C
Lead temperature 1,6 mm (1/16 inch) from case for 10 seconds	260°C

† Stresses beyond those listed under "absolute maximum ratings" may cause permanent damage to the device. These are stress ratings only, and functional operation of the device at these or any other conditions beyond those indicated under "recommended operating conditions" is not implied. Exposure to absolute-maximum-rated conditions for extended periods may affect device reliability.

NOTE 1: All voltages are with respect to the network ground terminal.

DISSIPATION RATING TABLE

PACKAGE	T _A = 25°C POWER RATING	DERATING FACTOR ABOVE T _A = 25°C	T _A = 70°C POWER RATING	T _A = 85°C POWER RATING
D	950 mW	7.6 mW/°C	608 mW	494 mW
DB	525 mW	4.2 mW/°C	336 mW	273 mW
N	1150 mW	9.2 mW/°C	736 mW	598 mW
NS	500 mW	4.0 mW/°C	320 mW	260 mW

SN65C189, SN65C189A, SN75C189, SN75C189A QUADRUPLE LOW-POWER LINE RECEIVERS

SLLS041D – OCTOBER 1988 – REVISED MAY 1995

recommended operating conditions

		MIN	NOM	MAX	UNIT
Supply voltage, V_{CC}		4.5	5	6	V
Input voltage, V_I (see Note 2)		-25		25	V
High-level output current, I_{OH}				-3.2	mA
Low-level output current, I_{OL}				3.2	mA
Response control current				±1	mA
Operating free-air temperature, T_A	SN65C189, SN65C189A	-40		85	°C
	SN75C189, SN75C189A	0		70	

NOTE 2: The algebraic convention, where the more positive (less negative) limit is designated as maximum, is used in this data sheet for logic levels only, e.g., if -10 V is a maximum, the typical value is a more negative voltage.

electrical characteristics over recommended free-air temperature range, $V_{CC} = 5\text{ V} \pm 10\%$ (unless otherwise noted) (see Note 3)

PARAMETER		TEST CONDITIONS		MIN	TYP†	MAX	UNIT	
V_{IT+}	Positive-going input threshold voltage	°C189	See Figure 1	1		1.5	V	
		°C189A		1.6		2.25		
V_{IT-}	Negative-going input threshold voltage	°C189	See Figure 1	0.75		1.25	V	
		°C189A		0.75	1	1.25		
V_{hys}	Input hysteresis voltage ($V_{IT+} - V_{IT-}$)	°C189	See Figure 1	0.15	0.33		V	
		°C189A		0.65	0.97			
V_{OH}	High-level output voltage	$V_{CC} = 4.5\text{ V to }6\text{ V}, V_I = 0.75\text{ V}, I_{OH} = -20\text{ }\mu\text{A}$		3.5			V	
		$V_{CC} = 4.5\text{ V to }6\text{ V}, V_I = 0.75\text{ V}, I_{OH} = -3.2\text{ mA}$		2.5				
V_{OL}	Low-level output voltage	$V_{CC} = 4.5\text{ V to }6\text{ V}, V_I = 3\text{ V}, I_{OL} = 3.2\text{ mA}$				0.4	V	
I_{IH}	High-level input current	See Figure 2		$V_I = 25\text{ V}$		8.3	mA	
				$V_I = 3\text{ V}$	0.43	1		
I_{IL}	Low-level input current	See Figure 2		$V_I = -25\text{ V}$		-8.3	mA	
				$V_I = -3\text{ V}$	-0.43	-1		
I_{OS}	Short-circuit output current	See Figure 3				-35	mA	
I_{CC}	Supply current	$V_I = 5\text{ V},$ See Figure 2		No load,		420	700	μA

† All typical values are at $T_A = 25^\circ\text{C}$.

NOTE 3: All characteristics are measured with response control terminal open.

switching characteristics, $V_{CC} = 5\text{ V} \pm 10\%$, $T_A = 25^\circ\text{C}$

PARAMETER	TEST CONDITIONS	MIN	TYP	MAX	UNIT
t_{PLH}	Propagation delay time, low- to high-level output			6	μs
t_{PHL}	Propagation delay time, high- to low-level output			6	μs
t_{TLH}	Transition time, low- to high-level output‡	$R_L = 5\text{ k}\Omega, C_L = 50\text{ pF},$ See Figure 4		500	ns
t_{THL}	Transition time, high- to low-level output‡			300	ns
$t_{W(N)}$	Duration of longest pulse rejected as noise§	1		6	μs

‡ Measured between 10% and 90% points of output waveform.

§ The receiver ignores any positive- or negative-going pulse that is less than the minimum value of $t_{W(N)}$ and accepts any positive- or negative-going pulse greater than the maximum of $t_{W(N)}$.



POST OFFICE BOX 855303 • DALLAS, TEXAS 75265

2-735

SN65C189, SN65C189A, SN75C189, SN75C189A QUADRUPLE LOW-POWER LINE RECEIVERS

SLLS041D – OCTOBER 1988 – REVISED MAY 1995

PARAMETER MEASUREMENT INFORMATION†

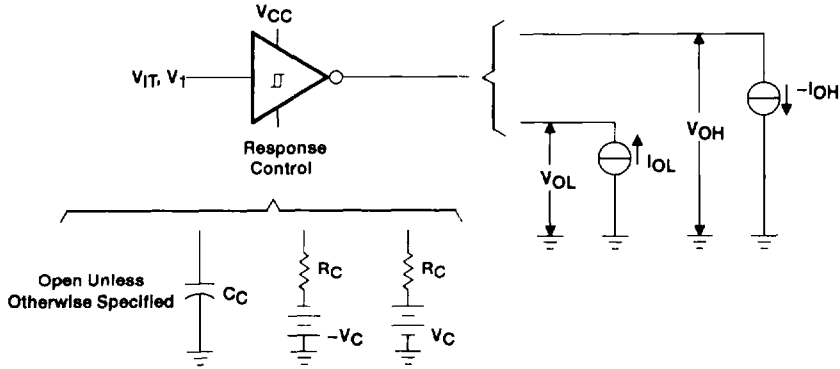

Figure 1. V_{T+} , V_{T-} , V_{OH} , V_{OL}

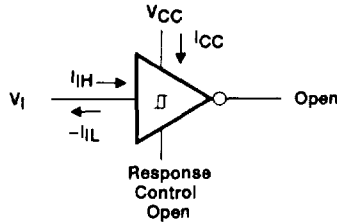

Figure 2. I_{IH} , I_{IL} , I_{CC}

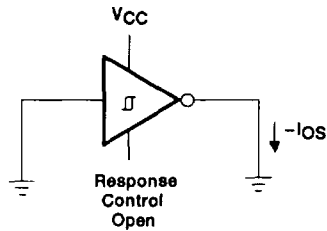

Figure 3. I_{OS}

† Arrows indicate actual direction of current flow. Current into a terminal is a positive value.

SN65C189, SN65C189A, SN75C189, SN75C189A QUADRUPLE LOW-POWER LINE RECEIVERS

SLLS041D - OCTOBER 1988 - REVISED MAY 1995

PARAMETER MEASUREMENT INFORMATION

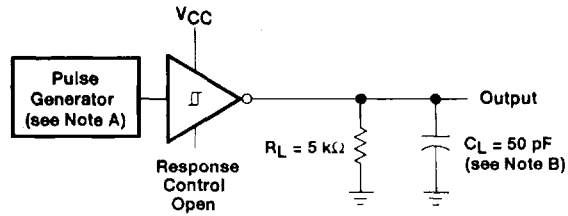

TEST CIRCUIT

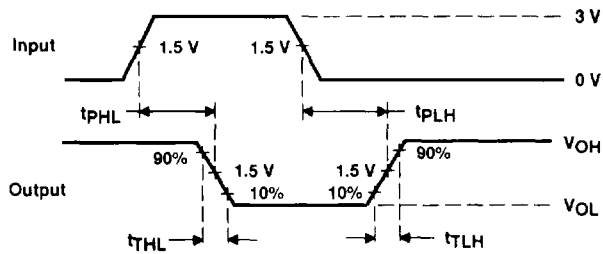

VOLTAGE WAVEFORMS

- NOTES: A. The pulse generator has the following characteristics: $Z_O = 50\ \Omega$, $t_w = 25\ \mu\text{s}$.
B. C_L includes probe and jig capacitances.

Figure 4. Test Circuit and Voltage Waveforms



POST OFFICE BOX 655303 • DALLAS, TEXAS 75285

2-737

SN65C189, SN65C189A, SN75C189, SN75C189A QUADRUPLE LOW-POWER LINE RECEIVERS

SLLS041D - OCTOBER 1988 - REVISED MAY 1995

TYPICAL CHARACTERISTICS

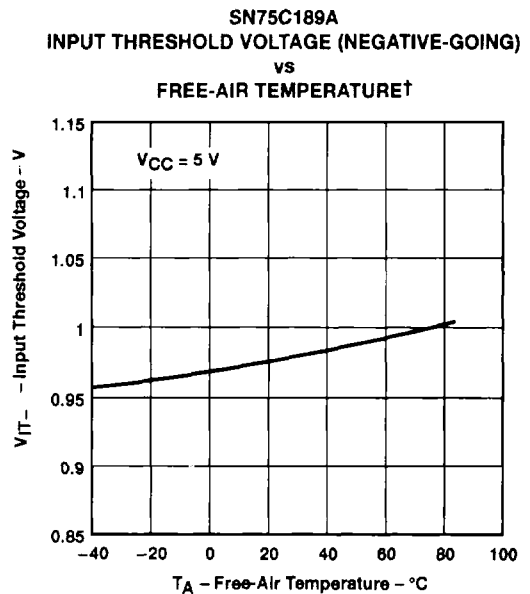
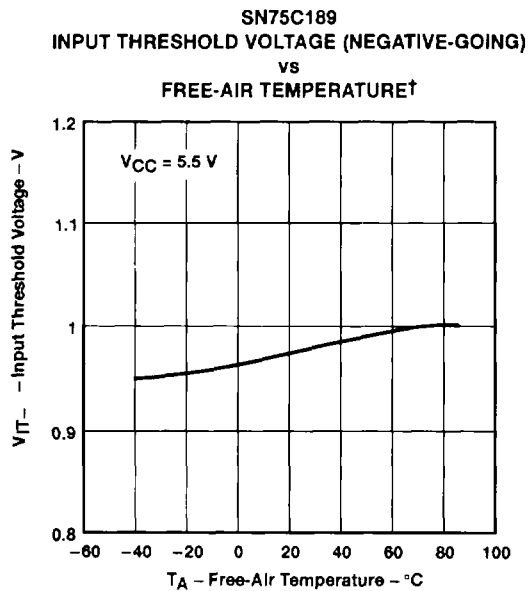
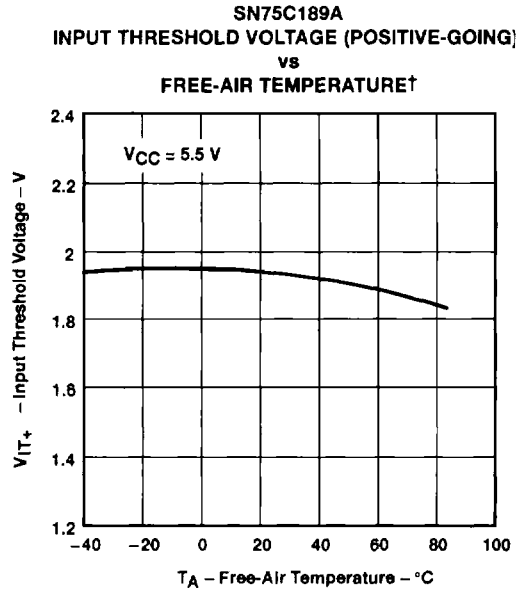
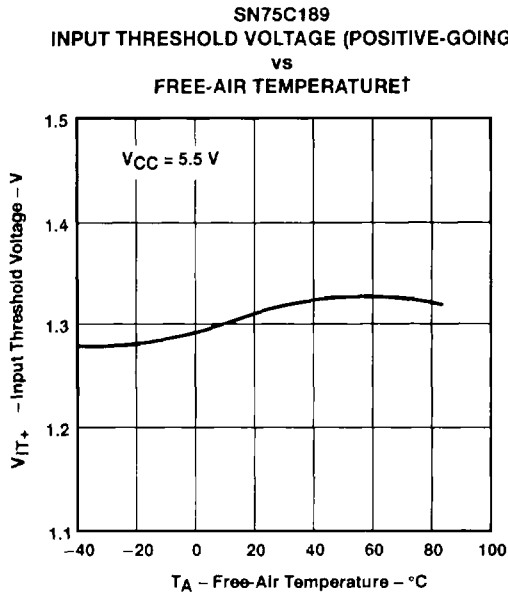

† Only the 0°C to 70°C portion of the curves applies to the SN75¹.



POST OFFICE BOX 655303 • DALLAS, TEXAS 75265

SN65C189, SN65C189A, SN75C189, SN75C189A QUADRUPLE LOW-POWER LINE RECEIVERS

SLLS041D - OCTOBER 1988 - REVISED MAY 1995

TYPICAL CHARACTERISTICS

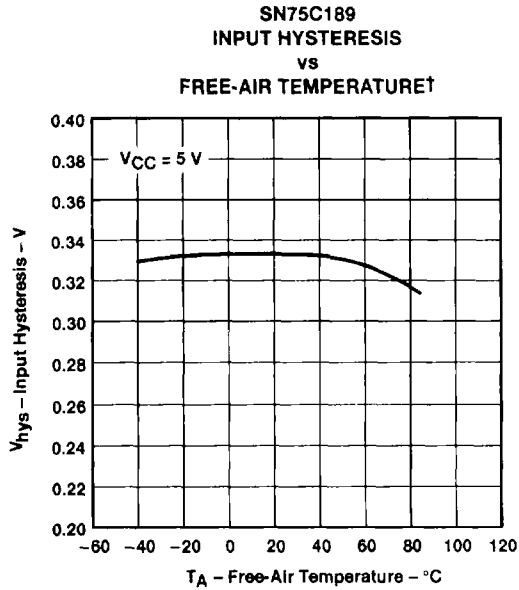

Figure 9

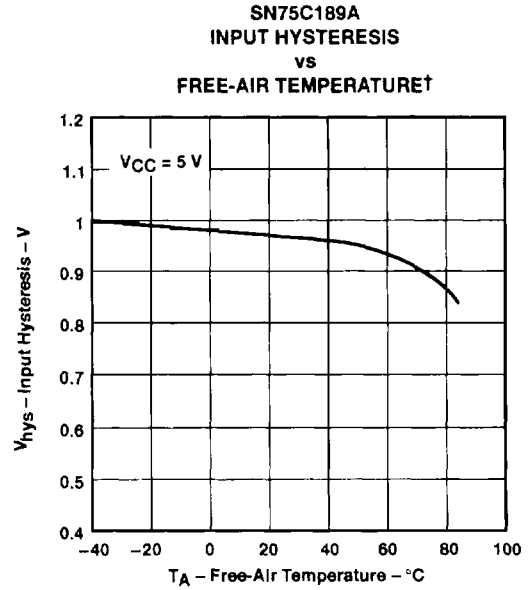

Figure 10

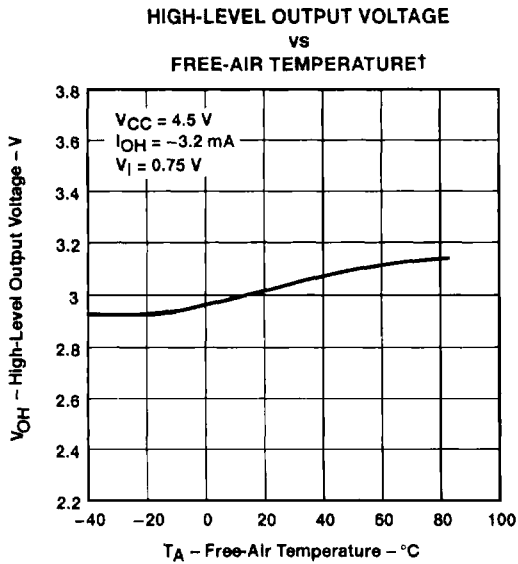

Figure 11

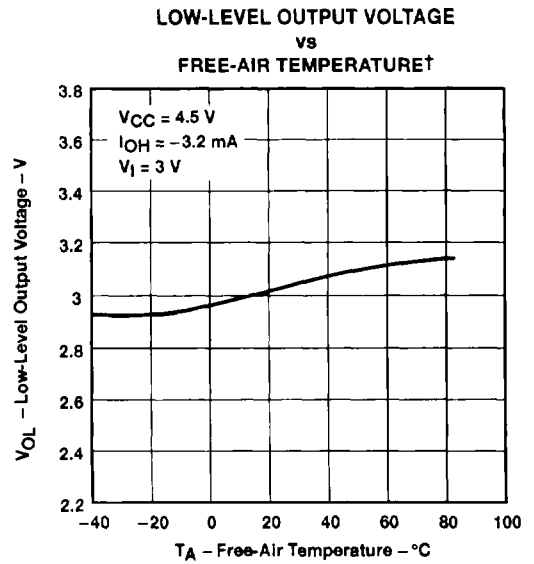

Figure 12

† Only the 0°C to 70°C portion of the curves applies to the SN75'.



SN65C189, SN65C189A, SN75C189, SN75C189A QUADRUPLE LOW-POWER LINE RECEIVERS

SLL5041D - OCTOBER 1988 - REVISED MAY 1995

TYPICAL CHARACTERISTICS

SN75C189
HIGH-LEVEL INPUT CURRENT
vs
FREE-AIR TEMPERATURE†

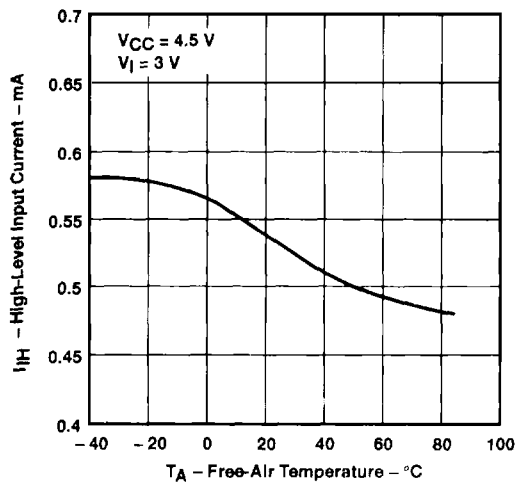

Figure 13

SN75C189A
HIGH-LEVEL INPUT CURRENT
vs
FREE-AIR TEMPERATURE†

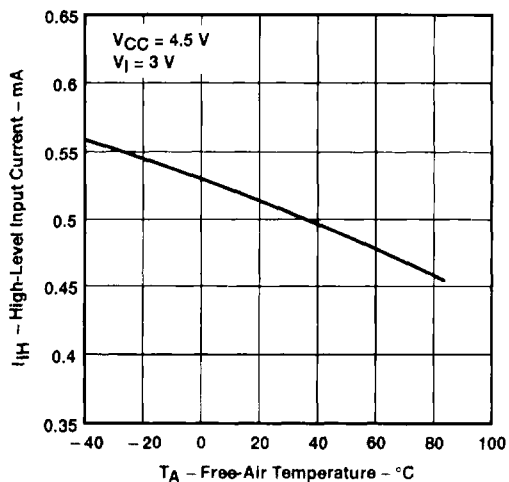

Figure 14

SN75C189
LOW-LEVEL INPUT CURRENT
vs
FREE-AIR TEMPERATURE†

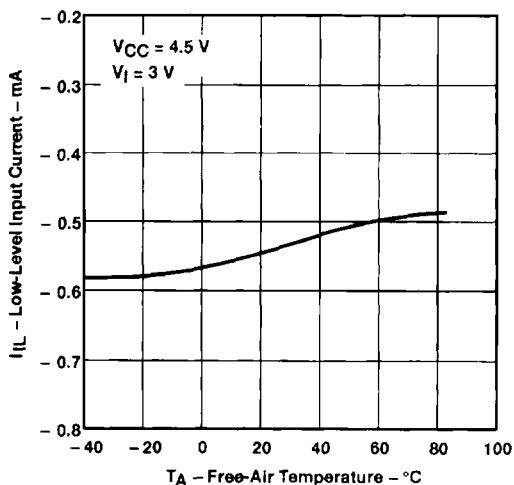

Figure 15

SN75C189A
LOW-LEVEL INPUT CURRENT
vs
FREE-AIR TEMPERATURE†

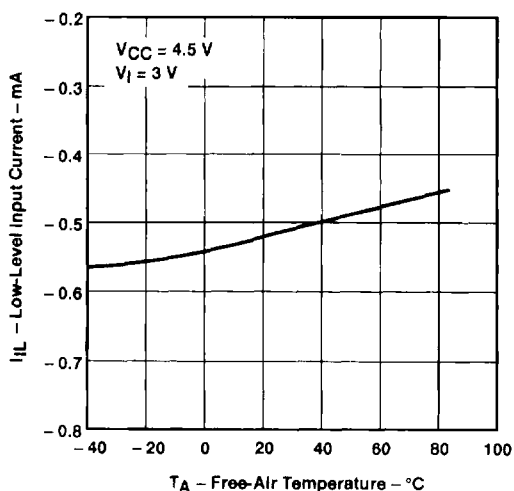

Figure 16

† Only the 0°C to 70°C portion of the curves applies to the SN75¹.



POST OFFICE BOX 655303 • DALLAS, TEXAS 75265

SN65C189, SN65C189A, SN75C189, SN75C189A QUADRUPLE LOW-POWER LINE RECEIVERS

SLLS041D - OCTOBER 1988 - REVISED MAY 1995

TYPICAL CHARACTERISTICS

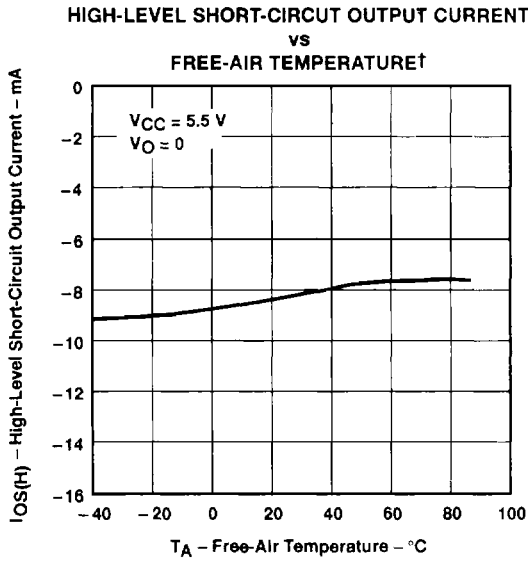

Figure 17

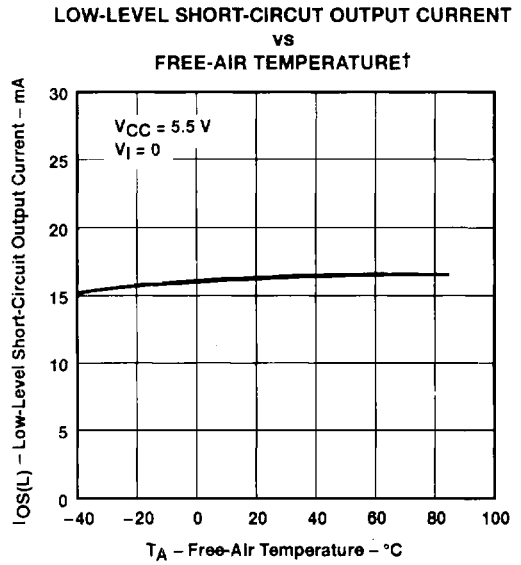

Figure 18

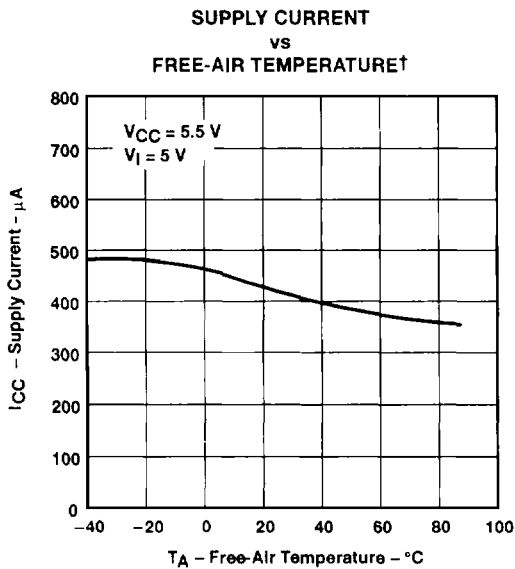

Figure 19

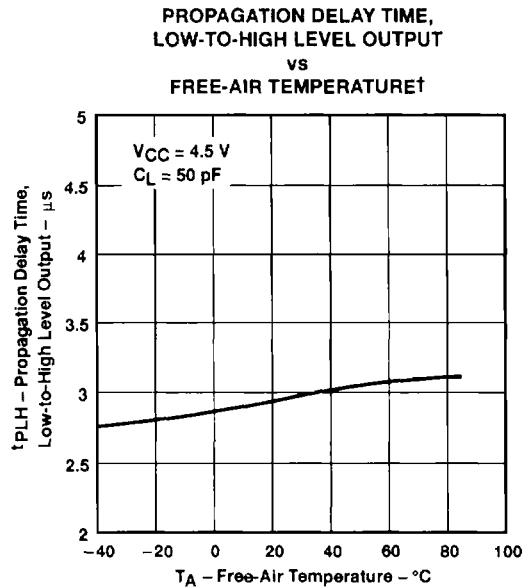

Figure 20

† Only the 0°C to 70°C portion of the curves applies to the SN75'.



SN65C189, SN65C189A, SN75C189, SN75C189A QUADRUPLE LOW-POWER LINE RECEIVERS

SLLS041D - OCTOBER 1988 - REVISED MAY 1995

TYPICAL CHARACTERISTICS

PROPAGATION DELAY TIME,
HIGH-TO-LOW-LEVEL OUTPUT
vs
FREE-AIR TEMPERATURE†

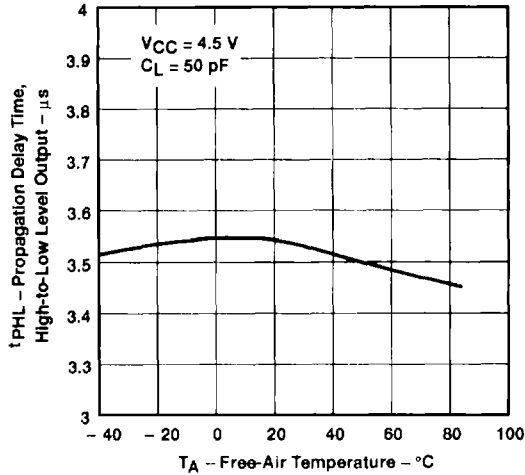

Figure 21

TRANSITION TIME,
LOW-TO-HIGH-LEVEL
vs
FREE-AIR TEMPERATURE†

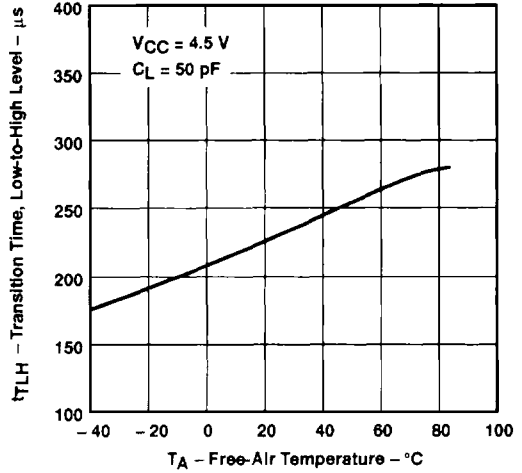

Figure 22

TRANSITION TIME,
HIGH-TO-LOW-LEVEL OUTPUT
vs
FREE-AIR TEMPERATURE†

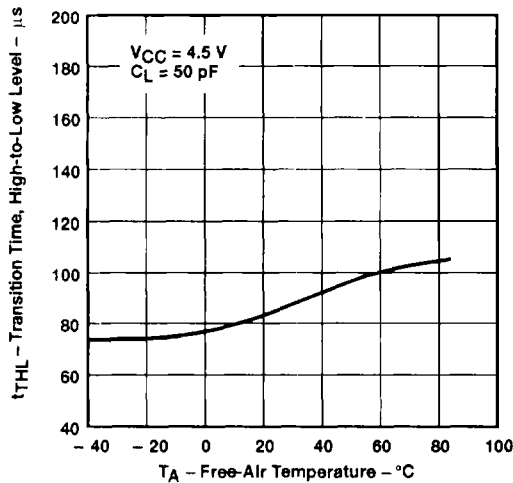

Figure 23

† Only the 0°C to 70°C portion of the curves applies to the SN75.



POST OFFICE BOX 655303 • DALLAS, TEXAS 75265