

**9005 • 9008
 9006**

**EXTENDABLE AND-OR-INVERT GATES
 EXTENDER (9006)**

DESCRIPTION: — The 9005 and 9008 are AND-OR-INVERT gates which may be OR extended with the use of the 9006.

ORDERING CODE: See Section 9

PKGS	PIN OUT	COMMERCIAL GRADE	MILITARY GRADE	PKG TYPE
		V _{CC} = +5.0 V ±5%, T _A = 0°C to +75°C	V _{CC} = +5.0 V ±10%, T _A = -55°C to +125°C	
Ceramic DIP (D)	A	9005DC	9005DM	6A
	B	9006DC	9006DM	
	C	9008DC	9008DM	
Flatpak (F)	A	9005FC	9005FM	3I
	B	9006FC	9006FM	
	C	9008FC	9008FM	

INPUT LOADING/FAN-OUT: See Section 3 for U.L. definitions

PINS	9005 (U.L.) HIGH/LOW	9006 (U.L.) HIGH/LOW	9008 (U.L.) HIGH/LOW
Non-extendable Gate Inputs	1.5/1.0		
Extendable Gate Inputs	2.25/1.5		
All Inputs	30/8.8	2.25/1.5	2.25/1.5
Outputs	(33)/(8.5)		(33)/(8.5)

*Outputs on 9006 have open-emitter and collector

**CONNECTION DIAGRAMS
 PINOUT A**

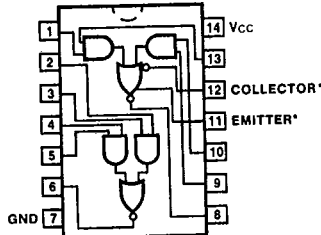

*Four extenders (9006) may be tied to these terminals

V_{CC} = Pin 14
 GND = Pin 7

PINOUT B

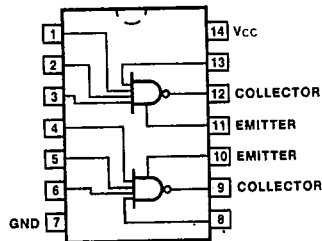

V_{CC} = Pin 14
 GND = Pin 7

PINOUT C

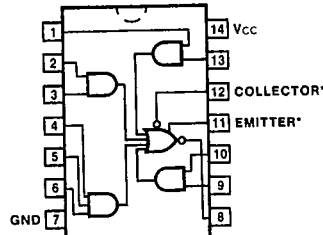

*Four extender (9006) may be tied to these terminals

V_{CC} = Pin 14
 GND = Pin 7

9XXX Series

NATIONAL SEMICONDUCTOR LOGIC D 6501122 0064083 7

T-43-15

DC AND AC CHARACTERISTICS OVER COMMERCIAL TEMPERATURE RANGE: $V_{CC} = +5.0\text{ V} \pm 5\%$

SYMBOL	PARAMETER	0°C		25°C		75°C		UNITS	CONDITIONS	
		Min	Max	Min	Max	Min	Max			
V_{IH}	Input HIGH Voltage	1.9		1.8		1.6		V	Guaranteed Input HIGH Threshold Voltage	
V_{IL}	Input LOW Voltage	0.85		0.85		0.85		V	Guaranteed Input LOW Threshold Voltage	
V_{OL}	Output LOW Voltage	0.45		0.45		0.45		V	$V_{CC} = 5.25\text{ V}$, $I_{OL} = 16\text{ mA}$,	
		0.45		0.45		0.45		V	$V_{CC} = 4.75\text{ V}$, $I_{OL} = 14.1\text{ mA}$	
I_{IL}	Input LOW Current 9005 Non-Extendable Gate	-1.6		-1.6		-1.6		mA	$V_{CC} = \text{Max}$ $V_{CC} = \text{Min}$	$V_{IN} = .45\text{ V}$ 5.25 V on Other Inputs
	Input LOW Current Extendable Gates and Extender	-1.41		-1.41		-1.41				
	Power Supply Current, ON 9005 Non-Extendable Gate 9005 Extendable Gate 9008	7.7		7.7		7.7		mA	All Inputs Open	
		13.6		13.6		13.6				
I_{CC}	Power Supply Current, OFF 9005 Non-Extendable Gate 9005 Extendable Gate 9008	3.4		3.4		3.4		mA	All Inputs Except Extender Inputs Gnd	
	5.1		5.1		5.1					
	10.2		10.2		10.2		mA	All Inputs HIGH		
	2.05		2.05		2.05					
ΔI_{CC}	Extra Current Drain when one 9006 Extender is attached to a 9005 Gate ON	2.54		2.54		2.54		mA	All Inputs Gnd	
	2.54		2.54		2.54					

DC AND AC CHARACTERISTICS OVER MILITARY TEMPERATURE RANGE: $V_{CC} = +5.0\text{ V} \pm 10\%$

SYMBOL	PARAMETER	-55°C		25°C		125°C		UNITS	CONDITIONS	
		Min	Max	Min	Max	Min	Max			
V_{IH}	Input HIGH Voltage	2.0		1.7		1.4		V	Guaranteed Input HIGH Threshold Voltage	
V_{IL}	Input LOW Voltage	0.8		0.9		0.8		V	Guaranteed Input LOW Threshold Voltage	
V_{OL}	Output LOW Voltage	0.4		0.4		0.4		V	$V_{CC} = 5.5\text{ V}$, $I_{OL} = 17.6\text{ mA}$	
		0.4		0.4		0.4		V	$V_{CC} = 4.5\text{ V}$, $I_{OL} = 13.6\text{ mA}$	
I_{IL}	Input LOW Current 9005 Non-extendable Gate	-1.6		-1.6		-1.6		mA	$V_{CC} = \text{Max}$ $V_{CC} = \text{Min}$	$V_{IN} = .4\text{ V}$ 5.5 V on Other Inputs
	Input LOW Current Extendable Gate and Extender	-1.24		-1.24		-1.24				
	Power Supply Current, ON 9005 Non-extendable Gate 9005 Extendable Gate 9008	-2.4		-2.4		-2.4		mA	All Inputs HIGH	
		-1.86		-1.86		-1.86				

NOTE:

Output characteristics above apply to a 9005 (both gates) or a 9008.

Input characteristics above apply to a 9005 (both gates) or a 9008 using either the internal gates or an external 9006 extender.

7-43-15

9XXX Series

NATIONAL SEMICONDUCTOR LOGIC DE D 6501122 0064084 9

DC AND AC CHARACTERISTICS OVER MILITARY TEMPERATURE RANGE: $V_{CC} = +5.0 \text{ V} \pm 10\%$ (Cont'd)

SYMBOL	PARAMETER	-55°C		25°C		125°C		UNITS	CONDITIONS
		Min	Max	Min	Max	Min	Max		
I _{CC}	Power Supply Current, ON 9005 Non-extendable Gate 9005 Extendable Gate 9008	6.5	11.3	6.5	11.3	6.5	11.3	mA	All Inputs Open
	Power Supply Current, OFF 9005 Non-extendable Gate 9005 Extendable Gate 9008	3.1	4.7	3.1	4.7	3.1	4.7		
ΔI _{CC}	Extra Current Drain from one 9006 Extender Gate ON	1.61		1.61		1.61		mA	All Inputs HIGH All Inputs Gnd 9006 Attached to a 9005
	Extra Current Drain from one 9006 Extender Gate OFF	2.35		2.35		2.35			

NOTE:
Output characteristics apply to a 9005 (both gates) or a 9008.
Input characteristics apply to a 9005 (both gates) or a 9008 using either the internal gates or an external 9006 extender.

SWITCHING CHARACTERISTICS (T_A = 25°C)

SYMBOL	LIMITS		UNITS	TEST CONDITIONS
	Min	Max		
t _{PLH} t _{PHL}	3.0	12	ns	V _{CC} = 5.0 V, C _L = 15 pF 9005 Non-extendable Gate Only, See Figure a
	3.0	14		
t _{PLH} t _{PHL}	3.0	15	ns	V _{CC} = 5.0 V, C _L = 15 pF, C _N = 5.0 pF 9005 Extendable Gate and 9008, See Figure b
	3.0	12		
Δt _{PLH} Δt _{PHL}	-2.0	4.0	ns	9006 Only The 9006 is tested by measuring its propagation time through the 9005. The delay readings shall not exceed the 9005 readings by the specified amount. See Figure c
	-2.0	4.0		

SWITCHING CHARACTERISTICS TEST CIRCUITS

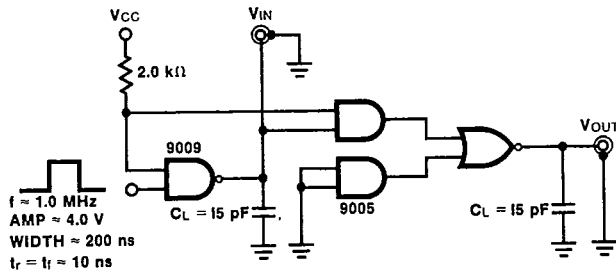

Note: Capacitance includes probe and jig capacitance

Fig. a 9005 Non-Extendable Gate

5

SWITCHING CHARACTERISTICS (Cont'd)
TEST CIRCUITS

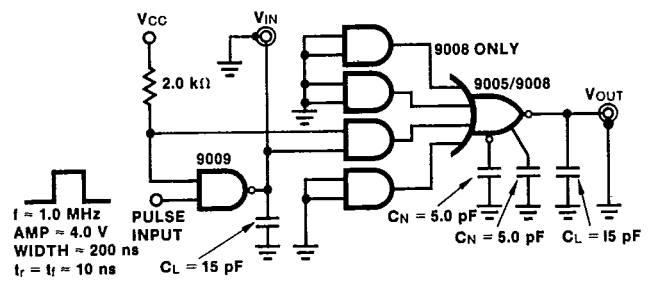

Note: Capacitance includes probe and jig capacitance

Fig. b 9005 or 9008 Extendable Gate

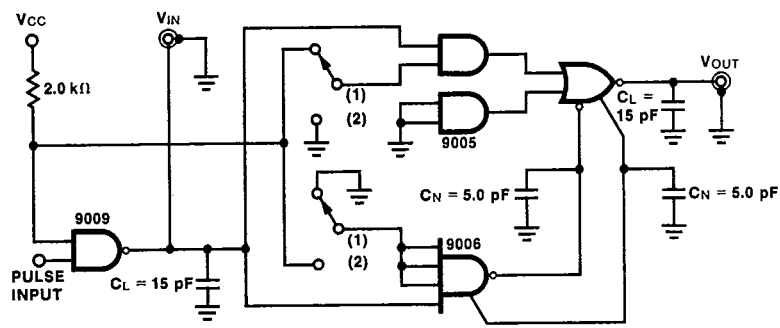

Note: Capacitance includes probe and jig capacitance

Fig. c 9006 Extender

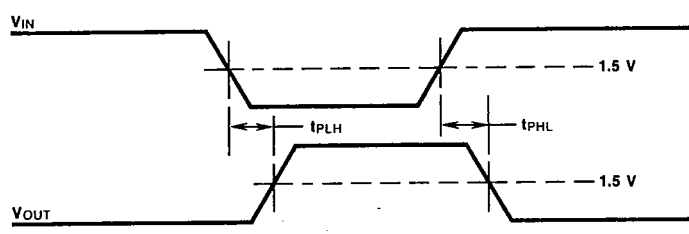

NOTES:
With switch in position (1) measure delay of 9005. With switch in position (2) measure delay (9005) + Δdelay (9006). Capacitances include probe and jig capacitances.

Fig. d Switching Waveform