

# MC74AC86, MC74ACT86

## Quad 2-Input Exclusive-OR Gate

- Outputs Source/Sink 24 mA

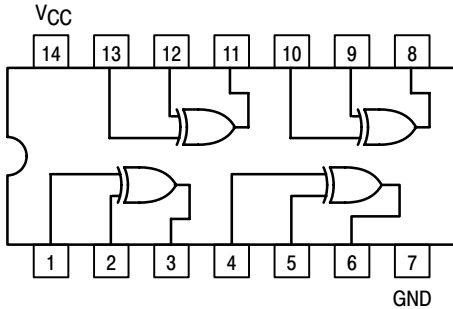

Figure 1. Pinout: 14-Lead Packages Conductors  
(Top View)

### MAXIMUM RATINGS\*

Rating	Symbol	Value	Unit
DC Supply Voltage (Referenced to GND)	$V_{CC}$	-0.5 to +7.0	V
DC Input Voltage (Referenced to GND)	$V_{in}$	-0.5 to $V_{CC} + 0.5$	V
DC Output Voltage (Referenced to GND)	$V_{out}$	-0.5 to $V_{CC} + 0.5$	V
DC Input Current, per Pin	$I_{in}$	$\pm 20$	mA
DC Output Sink/Source Current, per Pin	$I_{out}$	$\pm 50$	mA
DC $V_{CC}$ or GND Current per Output Pin	$I_{CC}$	$\pm 50$	mA
Storage Temperature	$T_{stg}$	-65 to +150	$^{\circ}C$

\*Maximum Ratings are those values beyond which damage to the device may occur. Functional operation should be restricted to the Recommended Operating Conditions.



ON Semiconductor®

<http://onsemi.com>

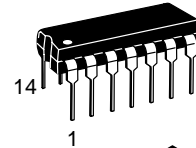

PDIP-14  
N SUFFIX  
CASE 646

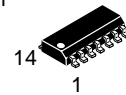

SO-14  
D SUFFIX  
CASE 751A

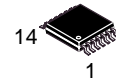

TSSOP-14  
DT SUFFIX  
CASE 948G

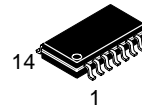

EIAJ-14  
M SUFFIX  
CASE 965

### ORDERING INFORMATION

Device	Package	Shipping
MC74AC86N	PDIP-14	25 Units/Rail
MC74ACT86N	PDIP-14	25 Units/Rail
MC74AC86D	SOIC-14	55 Units/Rail
MC74AC86DR2	SOIC-14	2500 Tape & Reel
MC74ACT86D	SOIC-14	55 Units/Rail
MC74ACT86DR2	SOIC-14	2500 Tape & Reel
MC74AC86DT	TSSOP-14	96 Units/Rail
MC74AC86DTR2	TSSOP-14	2500 Tape & Reel
MC74ACT86DT	TSSOP-14	96 Units/Rail
MC74ACT86DTR2	TSSOP-14	2500 Tape & Reel
MC74AC86M	EIAJ-14	50 Units/Rail
MC74ACT86M	EIAJ-14	50 Units/Rail
MC74ACT86MEL	EIAJ-14	2000 Tape & Reel

### DEVICE MARKING INFORMATION

See general marking information in the device marking section on page 266 of this data sheet.

# MC74AC86, MC74ACT86

## RECOMMENDED OPERATING CONDITIONS

Symbol	Parameter	Min	Typ	Max	Unit	
V <sub>CC</sub>	Supply Voltage	'AC	2.0	5.0	6.0	V
		'ACT	4.5	5.0	5.5	
V <sub>in</sub> , V <sub>out</sub>	DC Input Voltage, Output Voltage (Ref. to GND)	0		V <sub>CC</sub>	V	
t <sub>r</sub> , t <sub>f</sub>	Input Rise and Fall Time (Note 1) 'AC Devices except Schmitt Inputs	V <sub>CC</sub> @ 3.0 V	–	150	–	ns/V
		V <sub>CC</sub> @ 4.5 V	–	40	–	
		V <sub>CC</sub> @ 5.5 V	–	25	–	
t <sub>r</sub> , t <sub>f</sub>	Input Rise and Fall Time (Note 2) 'ACT Devices except Schmitt Inputs	V <sub>CC</sub> @ 4.5 V	–	10	–	ns/V
		V <sub>CC</sub> @ 5.5 V	–	8.0	–	
T <sub>J</sub>	Junction Temperature (PDIP)	–	–	140	°C	
T <sub>A</sub>	Operating Ambient Temperature Range	–40	25	85	°C	
I <sub>OH</sub>	Output Current – High	–	–	–24	mA	
I <sub>OL</sub>	Output Current – Low	–	–	24	mA	

- V<sub>in</sub> from 30% to 70% V<sub>CC</sub>; see individual Data Sheets for devices that differ from the typical input rise and fall times.
- V<sub>in</sub> from 0.8 V to 2.0 V; see individual Data Sheets for devices that differ from the typical input rise and fall times.

## DC CHARACTERISTICS

Symbol	Parameter	V <sub>CC</sub> (V)	74AC		74AC	Unit	Conditions
			T <sub>A</sub> = +25°C		T <sub>A</sub> = –40°C to +85°C		
			Typ	Guaranteed Limits			
V <sub>IH</sub>	Minimum High Level Input Voltage	3.0	1.5	2.1	2.1	V	V <sub>OUT</sub> = 0.1 V or V <sub>CC</sub> – 0.1 V
		4.5	2.25	3.15	3.15		
		5.5	2.75	3.85	3.85		
V <sub>IL</sub>	Maximum Low Level Input Voltage	3.0	1.5	0.9	0.9	V	V <sub>OUT</sub> = 0.1 V or V <sub>CC</sub> – 0.1 V
		4.5	2.25	1.35	1.35		
		5.5	2.75	1.65	1.65		
V <sub>OH</sub>	Minimum High Level Output Voltage	3.0	2.99	2.9	2.9	V	I <sub>OUT</sub> = –50 μA
		4.5	4.49	4.4	4.4		
		5.5	5.49	5.4	5.4		
		3.0	–	2.56	2.46	V	*V <sub>IN</sub> = V <sub>IL</sub> or V <sub>IH</sub> –12 mA I <sub>OH</sub> –24 mA –24 mA
		4.5	–	3.86	3.76		
5.5	–	4.86	4.76				
V <sub>OL</sub>	Maximum Low Level Output Voltage	3.0	0.002	0.1	0.1	V	I <sub>OUT</sub> = 50 μA
		4.5	0.001	0.1	0.1		
		5.5	0.001	0.1	0.1		
		3.0	–	0.36	0.44	V	*V <sub>IN</sub> = V <sub>IL</sub> or V <sub>IH</sub> 12 mA I <sub>OL</sub> 24 mA 24 mA
		4.5	–	0.36	0.44		
5.5	–	0.36	0.44				
I <sub>IN</sub>	Maximum Input Leakage Current	5.5	–	±0.1	±1.0	μA	V <sub>I</sub> = V <sub>CC</sub> , GND
I <sub>OLD</sub>	†Minimum Dynamic Output Current	5.5	–	–	75	mA	V <sub>OLD</sub> = 1.65 V Max
I <sub>OHD</sub>		5.5	–	–	–75	mA	V <sub>OHD</sub> = 3.85 V Min
I <sub>CC</sub>	Maximum Quiescent Supply Current	5.5	–	4.0	40	μA	V <sub>IN</sub> = V <sub>CC</sub> or GND

\*All outputs loaded; thresholds on input associated with output under test.

†Maximum test duration 2.0 ms, one output loaded at a time.

NOTE: I<sub>IN</sub> and I<sub>CC</sub> @ 3.0 V are guaranteed to be less than or equal to the respective limit @ 5.5 V V<sub>CC</sub>.

# MC74AC86, MC74ACT86

**AC CHARACTERISTICS** (For Figures and Waveforms – See Section 3 of the ON Semiconductor FACT Data Book, DL138/D)

Symbol	Parameter	V <sub>CC</sub> * (V)	74AC			74AC		Unit	Fig. No.
			T <sub>A</sub> = +25°C C <sub>L</sub> = 50 pF			T <sub>A</sub> = -40°C to +85°C C <sub>L</sub> = 50 pF			
			Min	Typ	Max	Min	Max		
t <sub>PLH</sub>	Propagation Delay Inputs to Outputs	3.3 5.0	2.0 1.5	6.0 4.5	11.5 8.5	1.5 1.0	12.5 9.0	ns	3-5
t <sub>PHL</sub>	Propagation Delay Inputs to Outputs	3.3 5.0	2.0 1.5	6.5 4.5	11.5 8.5	1.5 1.0	12.5 9.5	ns	3-5

\*Voltage Range 3.3 V is 3.3 V ±0.3 V.  
Voltage Range 5.0 V is 5.0 V ±0.5 V.

## DC CHARACTERISTICS

Symbol	Parameter	V <sub>CC</sub> (V)	74ACT		74ACT		Unit	Conditions
			T <sub>A</sub> = +25°C		T <sub>A</sub> = -40°C to +85°C			
			Typ	Guaranteed Limits	Typ	Guaranteed Limits		
V <sub>IH</sub>	Minimum High Level Input Voltage	4.5	1.5	2.0	2.0	V	V <sub>OUT</sub> = 0.1 V or V <sub>CC</sub> - 0.1 V	
		5.5	1.5	2.0	2.0			
V <sub>IL</sub>	Maximum Low Level Input Voltage	4.5	1.5	0.8	0.8	V	V <sub>OUT</sub> = 0.1 V or V <sub>CC</sub> - 0.1 V	
		5.5	1.5	0.8	0.8			
V <sub>OH</sub>	Minimum High Level Output Voltage	4.5	4.49	4.4	4.4	V	I <sub>OUT</sub> = -50 μA	
		5.5	5.49	5.4	5.4			
		4.5	-	3.86	3.76	V	*V <sub>IN</sub> = V <sub>IL</sub> or V <sub>IH</sub> -24 mA I <sub>OH</sub> -24 mA	
		5.5	-	4.86	4.76			
V <sub>OL</sub>	Maximum Low Level Output Voltage	4.5	0.001	0.1	0.1	V	I <sub>OUT</sub> = 50 μA	
		5.5	0.001	0.1	0.1			
		4.5	-	0.36	0.44	V	*V <sub>IN</sub> = V <sub>IL</sub> or V <sub>IH</sub> 24 mA I <sub>OL</sub> 24 mA	
		5.5	-	0.36	0.44			
I <sub>IN</sub>	Maximum Input Leakage Current	5.5	-	±0.1	±1.0	μA	V <sub>I</sub> = V <sub>CC</sub> , GND	
ΔI <sub>CC</sub> T	Additional Max. I <sub>CC</sub> /Input	5.5	0.6	-	1.5	mA	V <sub>I</sub> = V <sub>CC</sub> - 2.1 V	
I <sub>OLD</sub>	†Minimum Dynamic Output Current	5.5	-	-	75	mA	V <sub>OLD</sub> = 1.65 V Max	
I <sub>OHD</sub>		5.5	-	-	-75	mA	V <sub>OHD</sub> = 3.85 V Min	
I <sub>CC</sub>	Maximum Quiescent Supply Current	5.5	-	4.0	40	μA	V <sub>IN</sub> = V <sub>CC</sub> or GND	

\*All outputs loaded; thresholds on input associated with output under test.

†Maximum test duration 2.0 ms, one output loaded at a time.

# MC74AC86, MC74ACT86

**AC CHARACTERISTICS** (For Figures and Waveforms – See Section 3 of the ON Semiconductor FACT Data Book, DL138/D)

Symbol	Parameter	V <sub>CC</sub> * (V)	74ACT			74ACT		Unit	Fig. No.
			T <sub>A</sub> = +25°C C <sub>L</sub> = 50 pF			T <sub>A</sub> = -40°C to +85°C C <sub>L</sub> = 50 pF			
			Min	Typ	Max	Min	Max		
t <sub>PLH</sub>	Propagation Delay	5.0	1.5	8.5	9.5	1.0	10.0	ns	3-5
t <sub>PHL</sub>	Propagation Delay	5.0	1.5	7.0	9.5	1.0	10.5	ns	3-5

\*Voltage Range 5.0 V is 5.0 V ±0.5 V.

## CAPACITANCE

Symbol	Parameter	Value Typ	Unit	Test Conditions
C <sub>IN</sub>	Input Capacitance	4.5	pF	V <sub>CC</sub> = 5.0 V
C <sub>PD</sub>	Power Dissipation Capacitance	35	pF	V <sub>CC</sub> = 5.0 V

# MC74AC86, MC74ACT86

## MARKING DIAGRAMS

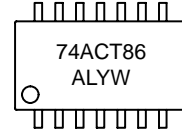
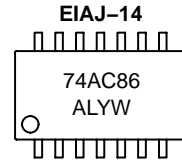
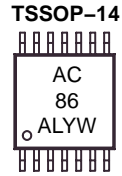
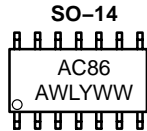
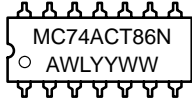
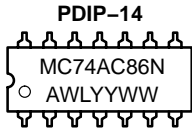

A = Assembly Location  
WL, L = Wafer Lot  
YY, Y = Year  
WW, W = Work Week