

## 74LCX257

### Low Voltage Quad 2-Input Multiplexer with 5V Tolerant Inputs and Outputs

#### General Description

The LCX257 is a quad 2-input multiplexer with 3-STATE outputs. Four bits of data from two sources can be selected using a Common Data Select input. The four outputs present the selected data in true (non inverted) form. The outputs may be switched to a high impedance state by placing a logic HIGH on the common Output Enable ( $\overline{OE}$ ) input, allowing the outputs to interface directly with bus-oriented systems.

The 74LCX257 is fabricated with advanced CMOS technology to achieve high speed operation while maintaining CMOS low power dissipation.

#### Features

- 5V tolerant inputs and outputs
- 2.3V–3.6V  $V_{CC}$  specifications provided
- 6.5 ns  $t_{PD}$  max ( $V_{CC} = 3.3V$ ), 10  $\mu A$   $I_{CC}$  max
- Power down high impedance inputs and outputs
- Supports live insertion/withdrawal (Note 1)
- Implements patented noise/EMI reduction circuitry
- Latch-up performance exceeds 500 mA
- ESD performance:
  - Human body model > 2000V
  - Machine model > 200V

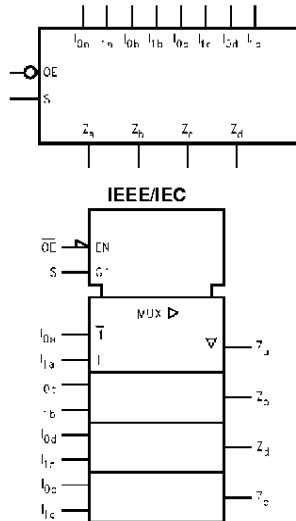
**Note 1:** To ensure the high-impedance state during power up or down  $\overline{OE}$  should be tied to  $V_{CC}$  through a pull-up resistor. The minimum value or the resistor is determined by the current-sourcing capability of the driver.

#### Ordering Code:

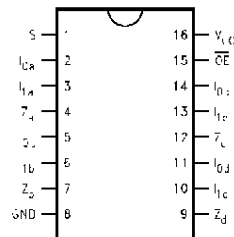
Order Number	Package Number	Package Description
74LCX257M	M16A	16-Lead Small Outline Integrated Circuit (SOIC), JEDEC MS-012, 0.150" Narrow
74LCX257SJ	M16D	16-Lead Small Outline Package (SOP), EIAJ TYPE II, 5.3mm Wide
74LCX257MTC	MTC16	16-Lead Thin Shrink Small Outline Package (TSSOP), JEDEC MO-153, 4.4mm Wide

Devices also available in Tape and Reel. Specify by appending the suffix letter 'X' to the ordering code.

#### Logic Symbols



#### Connection Diagram



#### Pin Descriptions

Pin Names	Description
S	Common Data Select Input
$\overline{OE}$	3-STATE Output Enable Input
$I_{0a}-I_{0d}$	Data Inputs from Source 0
$I_{1a}-I_{1d}$	Data Inputs from Source 1
$Z_a-Z_d$	3-STATE Multiplexer Outputs

## Functional Description

The LCX257 is a quad 2-input multiplexer with 3-STATE outputs. It selects four bits of data from two sources under control of a Common Data Select input. When the Select input is LOW, the  $I_{0x}$  inputs are selected and when Select is HIGH, the  $I_{1x}$  inputs are selected. The data on the selected inputs appears at the outputs in true (non inverted) form. The device is the logic implementation of a 4-pole, 2-position switch where the position of the switch is determined by the logic levels supplied to the Select input.

The logic equations for the outputs are shown below:

$$Z_a = \overline{OE} \cdot (I_{1a} \cdot S + I_{0a} \cdot \overline{S})$$

$$Z_b = \overline{OE} \cdot (I_{1b} \cdot S + I_{0b} \cdot \overline{S})$$

$$Z_c = \overline{OE} \cdot (I_{1c} \cdot S + I_{0c} \cdot \overline{S})$$

$$Z_d = \overline{OE} \cdot (I_{1d} \cdot S + I_{0d} \cdot \overline{S})$$

When the Output Enable ( $\overline{OE}$ ) is HIGH, the outputs are forced to a high impedance state. If the outputs are tied together, all but one device must be in the high impedance state to avoid high currents that would exceed the maximum ratings. Designers should ensure the Output Enable

signals to 3-STATE devices whose outputs are tied together are designed so there is no overlap.

## Truth Table

Output Enable	Select Input	Data Inputs		Outputs
		$I_0$	$I_1$	
H	X	X	X	Z
L	H	X	L	L
L	H	X	H	H
L	L	L	X	L
L	L	H	X	H

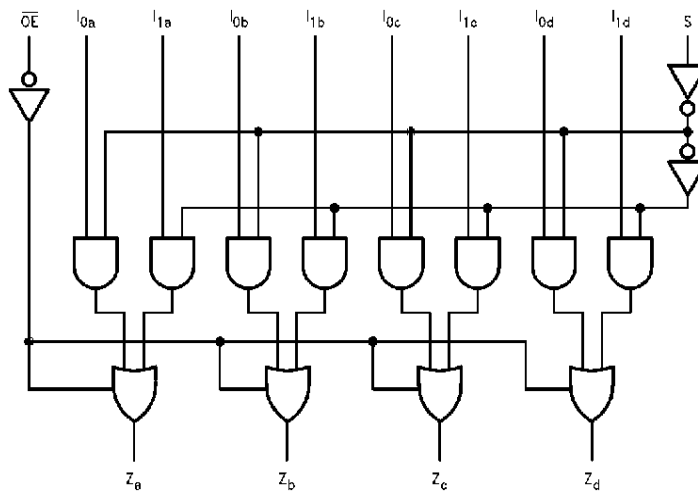
H = HIGH Voltage Level

L = LOW Voltage Level

X = Immaterial

Z = High Impedance

## Logic Diagram

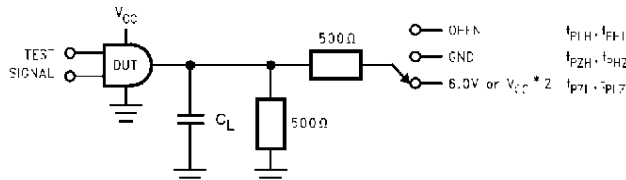


Please note that this diagram is provided only for the understanding of logic operations and should not be used to estimate propagation delays

Absolute Maximum Ratings (Note 1)						
Symbol	Parameter	Value	Conditions	Units		
$V_{CC}$	Supply Voltage	-0.5 to +7.0		V		
$V_I$	DC Input Voltage	-0.5 to +7.0		V		
$V_O$	DC Output Voltage	-0.5 to +7.0 -0.5 to $V_{CC} + 0.5$	Output in 3-STATE Output in HIGH or LOW State (Note 2)	V		
$I_{IK}$	DC Input Diode Current	-50	$V_I < GND$	mA		
$I_{OK}$	DC Output Diode Current	-50 +50	$V_O < GND$ $V_O > V_{CC}$	mA		
$I_O$	DC Output Source/Sink Current	$\pm 50$		mA		
$I_{CC}$	DC Supply Current per Supply Pin	$\pm 100$		mA		
$I_{GND}$	DC Ground Current per Ground Pin	$\pm 100$		mA		
$T_{STG}$	Storage Temperature	-65 to +150		°C		
Recommended Operating Conditions (Note 4)						
Symbol	Parameter	Min	Max	Units		
$V_{CC}$	Supply Voltage	Operating	2.0	3.6	V	
		Data Retention	1.5	3.6		
$V_I$	Input Voltage	0	5.5	V		
$V_O$	Output Voltage	HIGH or LOW State	0	$V_{CC}$	V	
		3-STATE	0	5.5		
$I_{OH}/I_{OL}$	Output Current	$V_{CC} = 3.0V - 3.6V$		$\pm 24$	mA	
		$V_{CC} = 2.7V - 3.0V$		$\pm 12$		
		$V_{CC} = 2.3V - 2.7V$		$\pm 8$		
$T_A$	Free-Air Operating Temperature	-40	85	°C		
$\Delta t/\Delta V$	Input Edge Rate, $V_{IN} = 0.8V - 2.0V$ , $V_{CC} = 3.0V$	0	10	ns/V		
<p><b>Note 2:</b> The Absolute Maximum Ratings are those values beyond which the safety of the device cannot be guaranteed. The device should not be operated at these limits. The parametric values defined in the Electrical Characteristics tables are not guaranteed at the Absolute Maximum Ratings. The 'Recommended Operating Conditions' table will define the conditions for actual device operation.</p> <p><b>Note 3:</b> <math>I_O</math> Absolute Maximum rating must be observed.</p> <p><b>Note 4:</b> Unused Inputs must be held HIGH or LOW. They may not float.</p>						
DC Electrical Characteristics						
Symbol	Parameter	Conditions	$V_{CC}$ (V)	$T_A = -40^\circ C$ to $+85^\circ C$		Units
				Min	Max	
$V_{IH}$	HIGH Level Input Voltage		2.3 - 2.7	1.7		V
			2.7 - 3.6	2.0		
$V_{IL}$	LOW Level Input Voltage		2.3 - 2.7		0.7	V
			2.7 - 3.6		0.8	
$V_{OH}$	HIGH Level Output Voltage	$I_{OH} = -100 \mu A$	2.3 - 3.6	$V_{CC} - 0.2$		V
		$I_{OH} = -8 \text{ mA}$	2.3	1.8		
		$I_{OH} = -12 \text{ mA}$	2.7	2.2		
		$I_{OH} = -18 \text{ mA}$	3.0	2.4		
		$I_{OH} = -24 \text{ mA}$	3.0	2.2		
$V_{OL}$	LOW Level Output Voltage	$I_{OL} = 100 \mu A$	2.3 - 3.6		0.2	V
		$I_{OL} = 8 \text{ mA}$	2.3		0.6	
		$I_{OL} = 12 \text{ mA}$	2.7		0.4	
		$I_{OL} = 16 \text{ mA}$	3.0		0.4	
		$I_{OL} = 24 \text{ mA}$	3.0		0.55	
$I_I$	Input Leakage Current	$0 \leq V_I \leq 5.5V$	2.3 - 3.6		$\pm 5.0$	$\mu A$
$I_{OZ}$	3-STATE Output Leakage	$0 \leq V_O \leq 5.5V$ $V_I = V_{IH}$ or $V_{IL}$	2.3 - 3.6		$\pm 5.0$	$\mu A$
$I_{OFF}$	Power-Off Leakage Current	$V_I$ or $V_O = 5.5V$	0		10	$\mu A$

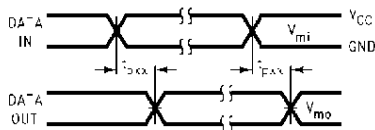
DC Electrical Characteristics (Continued)								
Symbol	Parameter	Conditions	V <sub>CC</sub> (V)	T <sub>A</sub> = -40°C to +85°C				Units
				Min	Max			
I <sub>CC</sub>	Quiescent Supply Current	V <sub>I</sub> = V <sub>CC</sub> or GND	2.3 – 3.6		10			μA
		3.6V ≤ V <sub>I</sub> , V <sub>O</sub> ≤ 5.5V (Note 5)	2.3 – 3.6		±10			
ΔI <sub>CC</sub>	Increase in I <sub>CC</sub> per Input	V <sub>IH</sub> = V <sub>CC</sub> - 0.6V	2.3 – 3.6		500			μA
<b>Note 5:</b> Outputs disabled or 3-STATE only								
AC Electrical Characteristics								
Symbol	Parameter	T <sub>A</sub> = -40°C to +85°C, R <sub>L</sub> = 500 Ω						Units
		V <sub>CC</sub> = 3.3V ± 0.3V		V <sub>CC</sub> = 2.7V		V <sub>CC</sub> = 2.5V ± 0.2V		
		C <sub>L</sub> = 50 pF		C <sub>L</sub> = 50 pF		C <sub>L</sub> = 30 pF		
		Min	Max	Min	Max	Min	Max	
t <sub>PHL</sub>	Propagation Delay	1.5	7.0	1.5	8.5	1.5	9.1	ns
t <sub>PLH</sub>	S → Z <sub>n</sub>	1.5	7.0	1.5	8.5	1.5	9.1	
t <sub>PHL</sub>	Propagation Delay	1.5	6.0	1.5	6.5	1.5	7.2	ns
t <sub>PLH</sub>	I <sub>n</sub> → Z <sub>n</sub>	1.5	6.0	1.5	6.5	1.5	7.2	
t <sub>PZL</sub>	Output Enable Time	1.5	7.0	1.5	8.5	1.5	9.1	ns
t <sub>PZH</sub>	OE → Z <sub>n</sub>	1.5	7.0	1.5	8.5	1.5	9.1	
t <sub>PLZ</sub>	Output Disable Time	1.5	5.5	1.5	6.0	4.0	6.6	ns
t <sub>PHZ</sub>	OE → Z <sub>n</sub>	1.5	5.5	1.5	6.0	2.0	6.6	
t <sub>OSHL</sub>	Output to Output Skew (Note 6)		1.0			4.0		ns
t <sub>OSLH</sub>			1.0			4.0		
<b>Note 6:</b> Skew is defined as the absolute value of the difference between the actual propagation delay for any two separate outputs of the same device. The specification applies to any outputs switching in the same direction, either HIGH-to-LOW (t <sub>OSHL</sub> ) or LOW-to-HIGH (t <sub>OSLH</sub> ).								
Dynamic Switching Characteristics								
Symbol	Parameter	Conditions	V <sub>CC</sub> (V)	T <sub>A</sub> = 25°C				Units
				Typical				
V <sub>OLP</sub>	Quiet Output Dynamic Peak V <sub>OL</sub>	C <sub>L</sub> = 50 pF, V <sub>IH</sub> = 3.3V, V <sub>IL</sub> = 0V	3.3	0.8			V	
		C <sub>L</sub> = 30 pF, V <sub>IH</sub> = 2.5V, V <sub>IL</sub> = 0V	2.5	0.6				
V <sub>OLV</sub>	Quiet Output Dynamic Valley V <sub>OL</sub>	C <sub>L</sub> = 50 pF, V <sub>IH</sub> = 3.3V, V <sub>IL</sub> = 0V	3.3	-0.8			V	
		C <sub>L</sub> = 30 pF, V <sub>IH</sub> = 2.5V, V <sub>IL</sub> = 0V	2.5	-0.6				
Capacitance								
Symbol	Parameter	Conditions	Typical		Units			
C <sub>IN</sub>	Input Capacitance	V <sub>CC</sub> = Open, V <sub>I</sub> = 0V or V <sub>CC</sub>	7		pF			
C <sub>OUT</sub>	Output Capacitance	V <sub>CC</sub> = 3.3V, V <sub>I</sub> = 0V or V <sub>CC</sub>	8		pF			
C <sub>PD</sub>	Power Dissipation Capacitance	V <sub>CC</sub> = 3.3V, V <sub>I</sub> = 0V or V <sub>CC</sub> , f = 10 MHz	25		pF			

**AC LOADING and WAVEFORMS** Generic for LCX Family

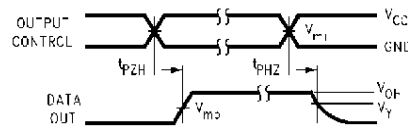


**FIGURE 1. AC Test Circuit ( $C_L$  includes probe and jig capacitance)**

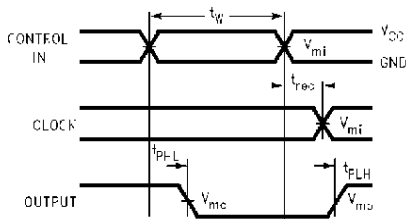
Test	Switch
$t_{PLH}, t_{PHL}$	Open
$t_{PZL}, t_{PLZ}$	6V at $V_{CC} = 3.3 \pm 0.3V$ $V_{CC} \times 2$ at $V_{CC} = 2.5 \pm 0.2V$
$t_{PZH}, t_{PHZ}$	GND



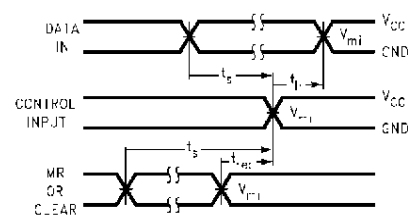
**Waveform for Inverting and Non-Inverting Functions**



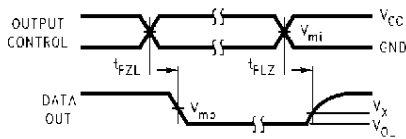
**3-STATE Output High Enable and Disable Times for Logic**



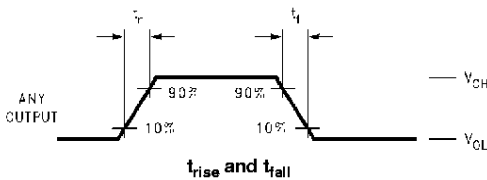
**Propagation Delay, Pulse Width and  $t_{rec}$  Waveforms**



**Setup Time, Hold Time and Recovery Time for Logic**



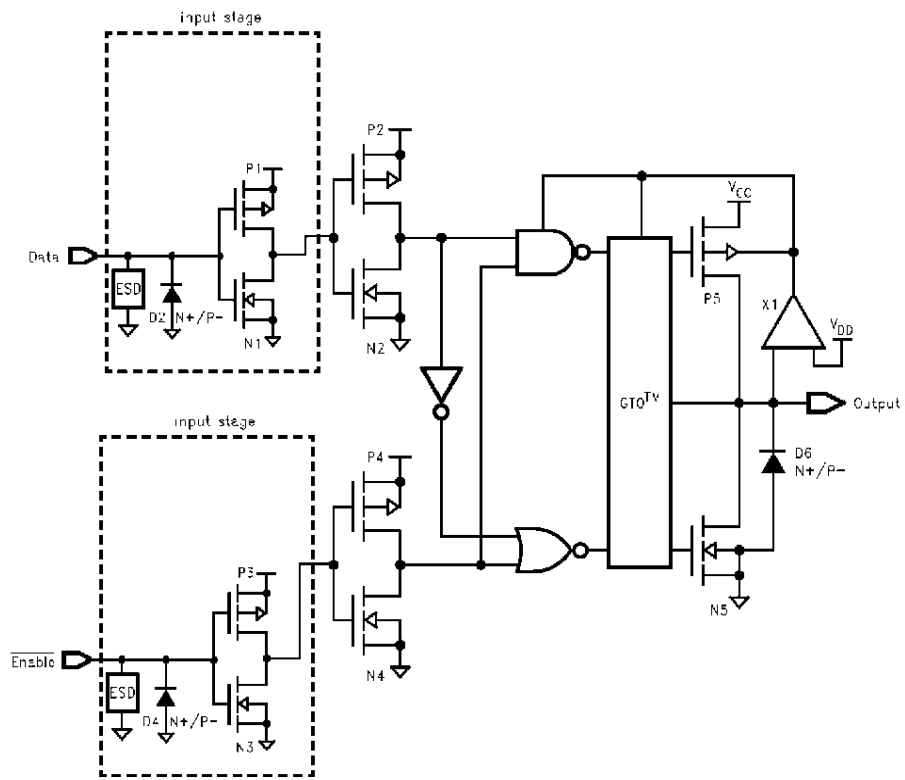
**3-STATE Output Low Enable and Disable Times for Logic**



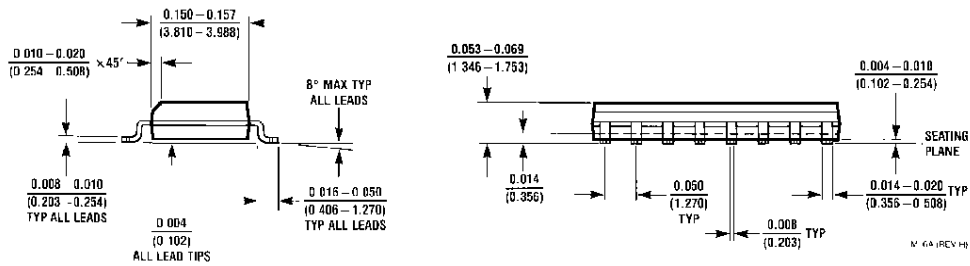
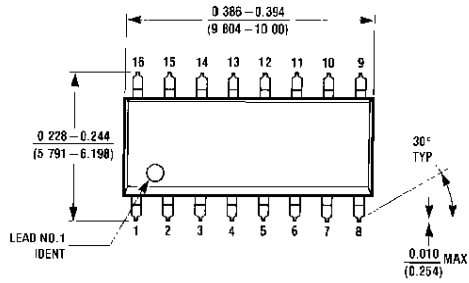
**FIGURE 2. Waveforms (Input Characteristics;  $f = 1MHz, t_R = t_F = 3ns$ )**

Symbol	$V_{CC}$		
	$3.3V \pm 0.3V$	2.7V	$2.5V \pm 0.2V$
$V_{mi}$	1.5V	1.5V	$V_{CC}/2$
$V_{m0}$	1.5V	1.5V	$V_{CC}/2$
$V_x$	$V_{OL} + 0.3V$	$V_{OL} + 0.3V$	$V_{OL} + 0.15V$
$V_y$	$V_{OH} - 0.3V$	$V_{OH} - 0.3V$	$V_{OH} - 0.15V$

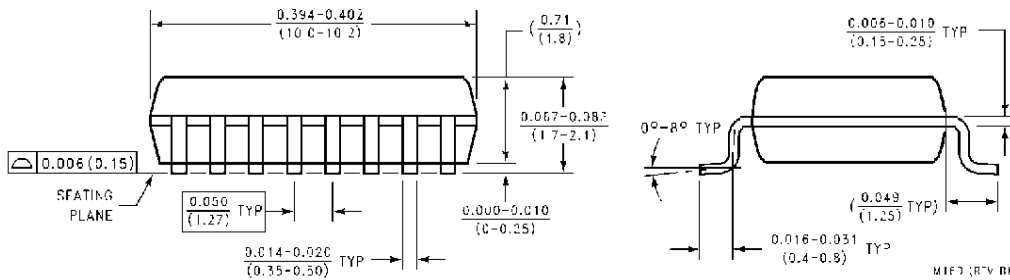
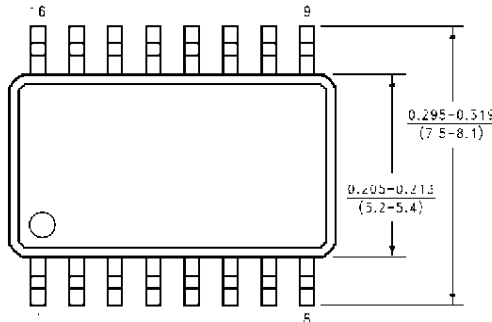
Schematic Diagram Generic for LCX Family



**Physical Dimensions** inches (millimeters) unless otherwise noted

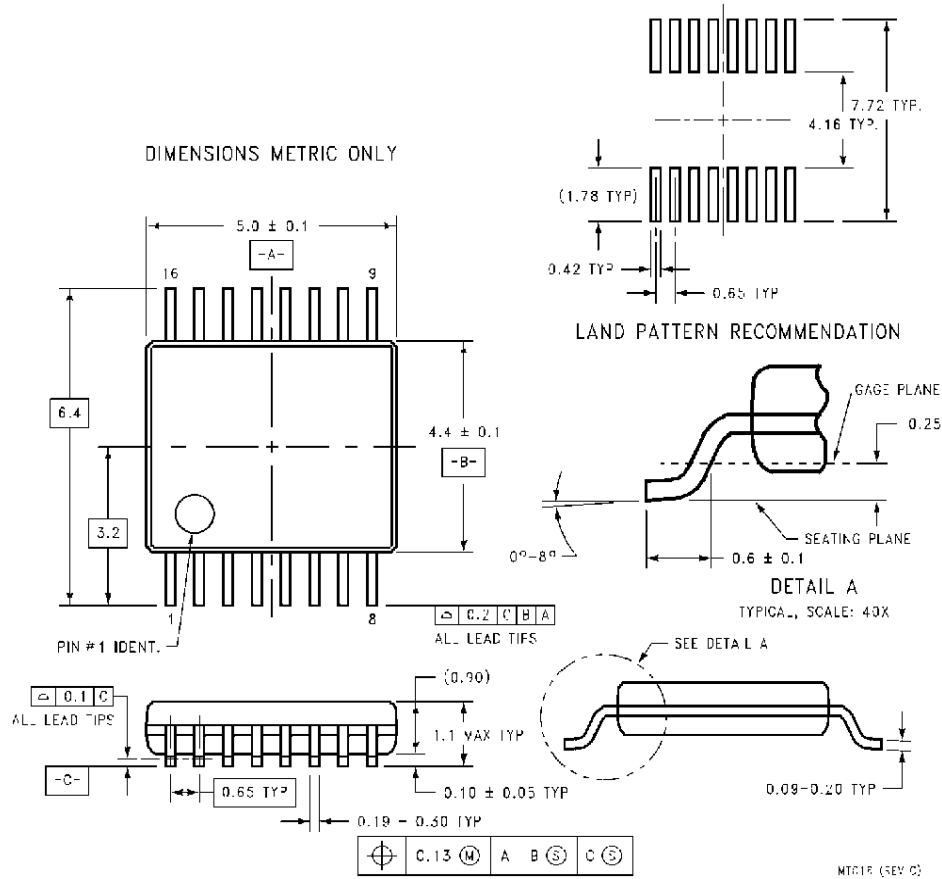


**16-Lead Small Outline Integrated Circuit (SOIC), JEDEC MS-012, 0.150" Narrow  
Package Number M16A**



**16-Lead Small Outline Package (SOP), EIAJ TYPE II, 5.3mm Wide  
Package Number M16D**

**Physical Dimensions** inches (millimeters) unless otherwise noted (Continued)



**16-Lead Thin Shrink Small Outline Package (TSSOP), JEDEC MO-153, 4.4mm Wide  
Package Number MTC16**

**LIFE SUPPORT POLICY**

FAIRCHILD'S PRODUCTS ARE NOT AUTHORIZED FOR USE AS CRITICAL COMPONENTS IN LIFE SUPPORT DEVICES OR SYSTEMS WITHOUT THE EXPRESS WRITTEN APPROVAL OF THE PRESIDENT OF FAIRCHILD SEMICONDUCTOR CORPORATION. As used herein:

1. Life support devices or systems are devices or systems which, (a) are intended for surgical implant into the body, or (b) support or sustain life, and (c) whose failure to perform when properly used in accordance with instructions for use provided in the labeling, can be reasonably expected to result in a significant injury to the user.
2. A critical component in any component of a life support device or system whose failure to perform can be reasonably expected to cause the failure of the life support device or system, or to affect its safety or effectiveness.

[www.fairchildsemi.com](http://www.fairchildsemi.com)