

<p>NPN型 小功率 贴片开关三极管 NPN Switching Transistor SMD</p>	<p>MMBT3904 对应其他工业型号 3904</p>
<ul style="list-style-type: none"> ■ Excellent hFE linearity ■ Low noise ■ Transistor Polarity: NPN ■ Transistor pinout: BEC ■ SOT-23 Package ■ Marking Code: 1AM ■ hFE: 100~200, 200~300 	

<p>Inner circuit</p>  <p>SOT-23 内部结构</p>	<p>MMBT3904</p>  <p>1. Base 2. Emitter 3. Collector</p> <p>SOT-23 管脚排列</p>	<p>元件标识 (打印)</p>  <p>DEVICE MARKING</p>
---	---	--

■ CLASSIFICATION OF hFE

RANK	L	H
RANGE	100~200	200~300

■ MAXIMUM RATINGS

Parameter	Symbol	Value	Unit
Collector-Base Voltage	V_{CBO}	60	V
Collector-Emitter Voltage	V_{CEO}	40	V
Emitter-Base Voltage	V_{EBO}	6	V
Collector Current	I_C	200	mA
Collector Power Dissipation	P_C	300	mW
Thermal Resistance From Junction To Ambient	$R_{\theta JA}$	417	$^{\circ}C/W$
Operation Junction and Storage Temperature Range	T_J, T_{stg}	-55~+150	$^{\circ}C$

■ ELECTRICAL CHARACTERISTICS (T_A=25°C unless otherwise noted)

Characteristic	Test Condition	Symbol	Min	Typ	Max	Unit
Collector-Emitter Breakdown Voltage	I _B =0, I _C =1mA	V _{(BR)CEO}	40	--	--	V
Collector-Base Breakdown Voltage	I _E =0, I _C =10μA	V _{(BR)CBO}	60	--	--	
Emitter-Base Breakdown Voltage	I _C =0, I _E =10μA	V _{(BR)EBO}	6.0	--	--	
Base Cutoff Current	V _{CE} =30V, V _{EB} =3V	I _{BEX}	--	--	50	nA
Collector Cutoff Current	V _{CE} =30V, V _{EB} =3V	I _{CEx}	--	--	50	
DC Current Gain	I _C =0.1mA, V _{CE} =1V	hFE	40	--	--	
	I _C =1mA, V _{CE} =1V		70	--	--	
	I _C =10mA, V _{CE} =1V		100	--	300	
	I _C =50mA, V _{CE} =1V		60	--	--	
	I _C =100mA, V _{CE} =1V		30	--	300	
Collector-Emitter Saturation Voltage	I _C =10mA, I _B =1mA	V _{CE(sat)}	--	--	0.25	V
	I _C =50mA, I _B =5mA		--	--	0.40	
Base-Emitter Saturation Voltage	I _C =10mA, I _B =1mA	V _{BE(sat)}	0.65	--	0.85	
	I _C =50mA, I _B =5mA		--	--	0.95	
Current-Gain-Bandwidth Product	I _C =0mA, V _{CE} =-20V f=100MHz	f _T	300	--	--	MHz
Collector Output Capacitance	V _{CB} =5V, I _E =0, f=1MHz	C _{OB}	--	--	4.0	pF
Input Capacitance	V _{EB} =0.5V, I _C =0, f=1MHz	C _{ibo}	--	--	8.0	
Input Impedance	I _C =1mA, V _{CE} =10V, f=1kHz	h _{ie}	1.0	--	10	KΩ
Voltage Feedback Ratio	I _C =1mA, V _{CE} =10V, f=1kHz	h _{re}	0.5	--	8.0	× 10 ⁻⁴
Small-Signal Current Gain	I _C =1mA, V _{CE} =10V, f=1kHz	hFE	100	--	400	
Output Admittance	I _C =1mA, V _{CE} =10V, f=1kHz	h _{oe}	1.0	--	40	μΩ
Noise Figure	I _C =100μA, V _{CE} =5V, R _s =1KΩ, f=1kHz	NF	--	--	5.0	db
Delay Time	V _{CC} =3V, V _{BE(off)} =-0.5V I _C =10mA, I _B 1=1mA	t _d	--	--	35	nS
Rise Time		t _r	--	--	35	
Storage Time	V _{CC} =3V, I _C =10mA I _B 1 = I _B 2 = 1mA	t _s	--	--	225	
Fall Time		t _f	--	--	75	

1. FR-5 = 1.0 × 0.75 × 0.062 in.

2. Alumina = 0.4 × 0.3 × 0.024 in. 99.5% alumina.

3. Pulse Width ≤ 300us; Duty Cycle ≤ 2.0%.

4. Pulse Test: Pulse Width ≤ 300us; Duty Cycle ≤ 2.0%.

■ TYPICAL CHARACTERISTICS

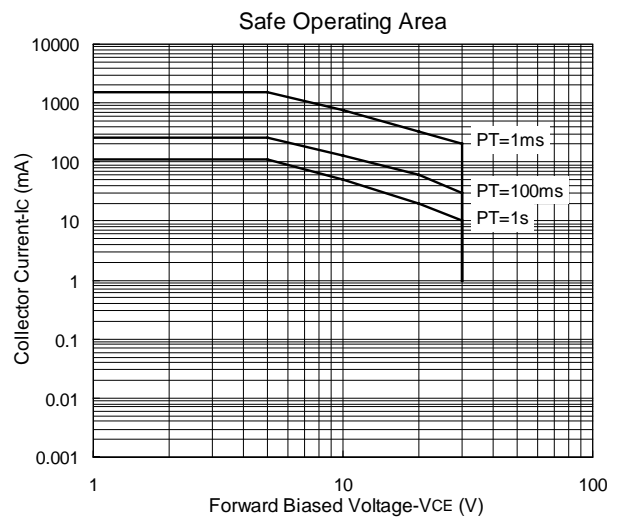
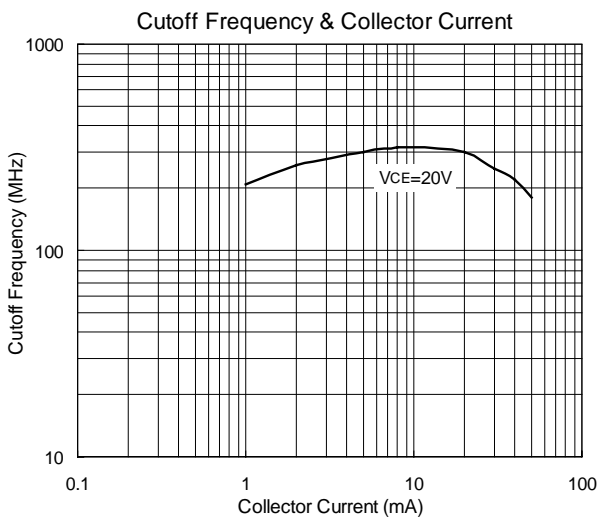
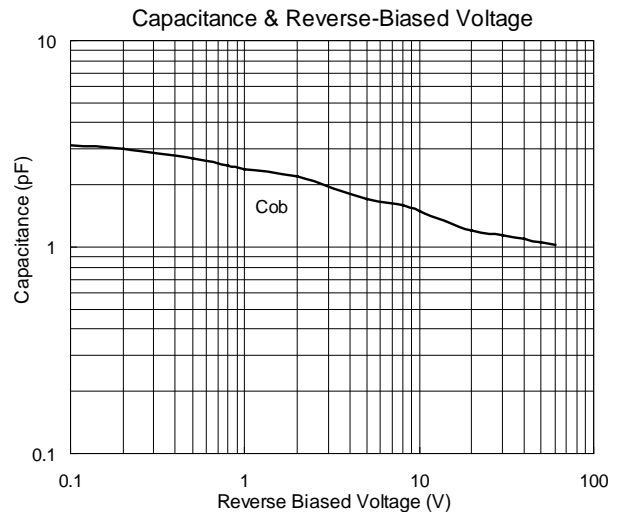
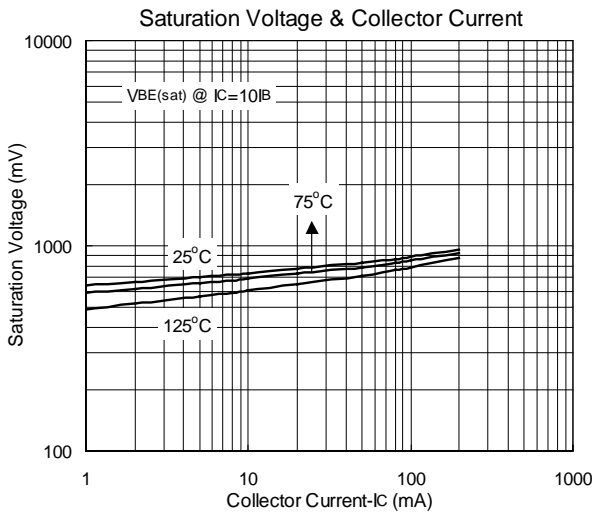
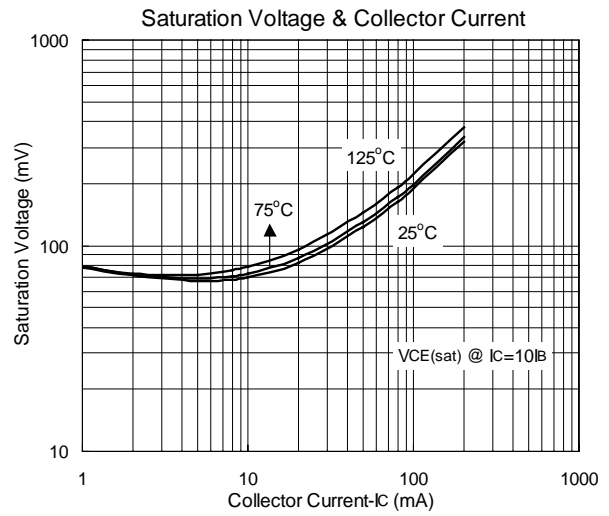
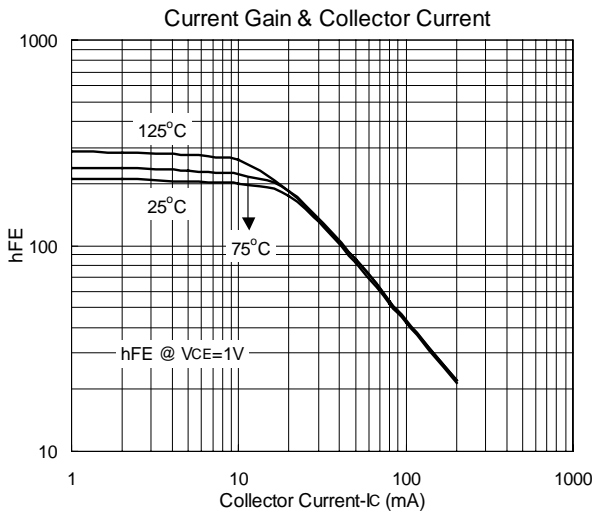

■ DIMENSION

单位 (UNIT) : mm

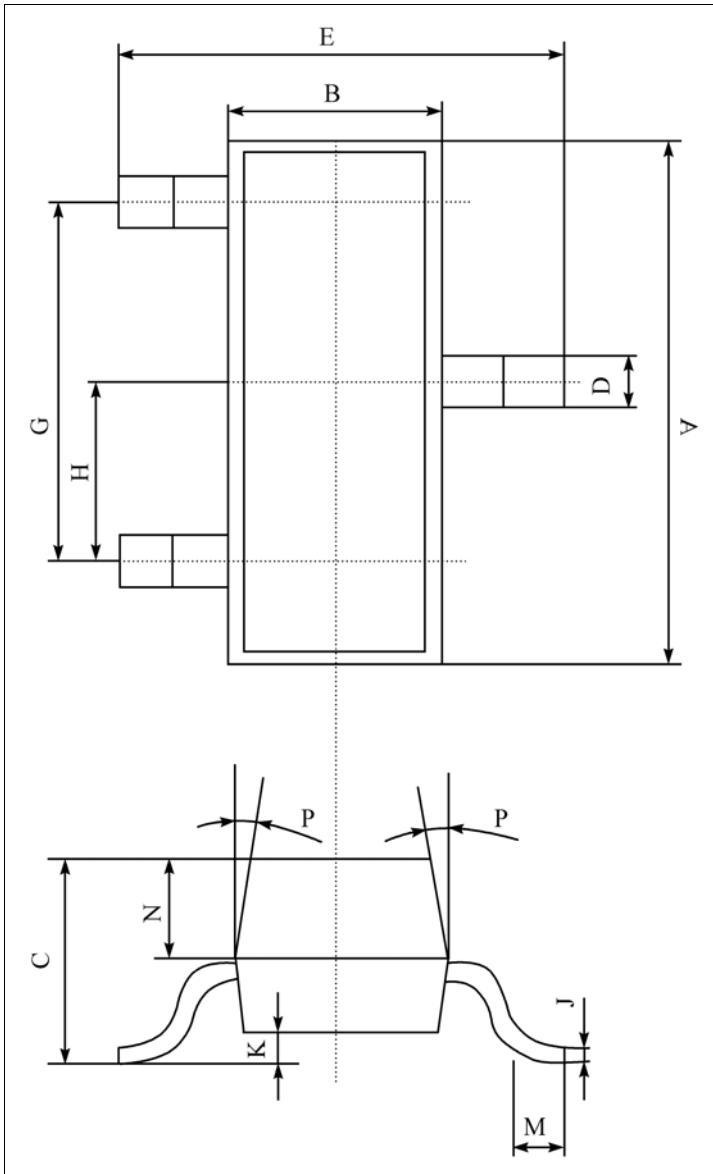

序号	数值及公差
A	2.90±0.10
B	1.30±0.10
C	1.00±0.10
D	0.40±0.10
E	2.40±0.20
G	1.90±0.10
H	0.95±0.05
J	0.13±0.05
K	0.00-0.10
M	≥0.20
N	0.60±0.10
P	7±2°

Packing
SOT-23 包装规格
SMD片式表面贴封装
包装方式: 载带卷盘包装
Tape & Reel, 3Kpcs/Reel
每卷数量3000只 (3Kpcs/Reel)
每盒数量45000只 (45Kpcs/BOX)
每箱数量180000只 (180Kpcs/Cartons)

SOT-23 Tape and reel

SOT-23 Embossed Carrier Tape

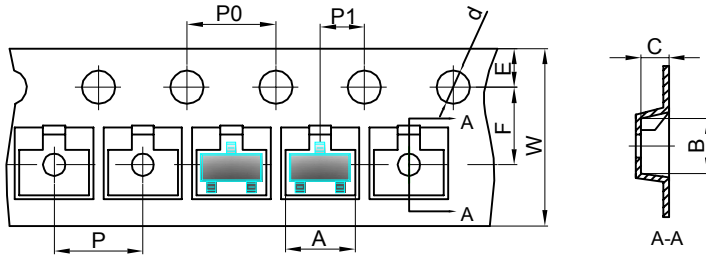

Dimensions are in millimeter										
Pkg type	A	B	C	d	E	F	P0	P	P1	W
SOT-23	3.15	2.77	1.22	Ø1.50	1.75	3.50	4.00	4.00	2.00	8.00

SOT-23 Tape Leader and Trailer

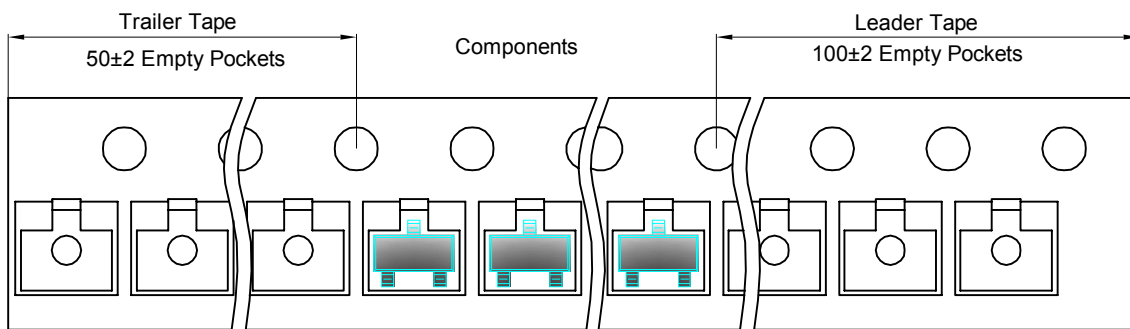

SOT-23 Reel

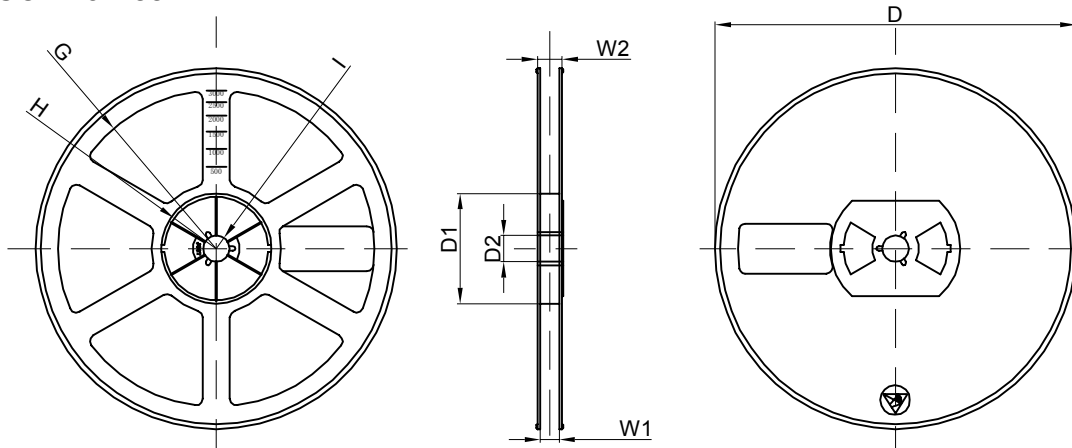

Dimensions are in millimeter								
Reel Option	D	D1	D2	G	H	I	W1	W2
7" Dia	Ø178.00	54.40	13.00	R78.00	R25.60	R6.50	9.50	12.30

REEL	Reel Size	Box	Box Size(mm)	Carton	Carton Size(mm)	G.W.(kg)
3000 pcs	7 inch	45,000 pcs	192×192×193	180,000 pcs	404×404×214	