

■ PRODUCT CHARACTERISTICS

BVCBO	700V
BVCEO	400V
HFE@5V2A	8-40
IC	8A

Symbol

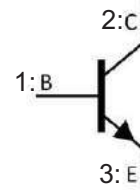

■ APPLICATIONS

- Fluorescent lamp
- Electronic ballast
- Electronic transformer
- Switch mode power supply

■ FEATURES

- * $V_{CEO(SUS)}$ 400V
- * 700V Blocking Capability

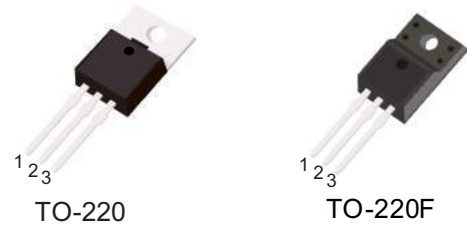

■ ORDER INFORMATION

Order codes		Package	Packing
Halogen-Free	Halogen		
N/A	MOT13007MF	TO-220F	50 pieces/Tube
N/A	MOT13007MA	TO-220	50 pieces/Tube

■ ABSOLUTE MAXIMUM RATING

PARAMETER	SYMBOL	RATINGS	UNIT
Collector-Emitter Sustaining Voltage	V_{CEO}	400	V
Collector-Emitter Breakdown Voltage	V_{CBO}	700	V
Emitter-Base Voltage	V_{EBO}	9.0	V
Collector Current	Continuous	I_C	8.0
	Peak (1)	I_{CM}	16
Base Current	Continuous	I_B	4.0
	Peak (1)	I_{BM}	8.0
Emitter Current	Continuous	I_E	12
	Peak (1)	I_{EM}	24
Total Device Dissipation	$T_C = 25^\circ\text{C}$	P_D	80
Operating and Storage Junction Temperature	T_J, T_{STG}	-55~+150	$^\circ\text{C}$

Note: Absolute maximum ratings are those values beyond which the device could be permanently damaged. Absolute maximum ratings are stress ratings only and functional device operation is not implied.

■ THERMAL DATA

PARAMETER	SYMBOL	RATINGS	UNIT
Junction to Case	θ_{JC}	1.56	$^\circ\text{C/W}$
Junction to Ambient	θ_{JA}	62.5	$^\circ\text{C/W}$

Note 1: Pulse Test: Pulse Width = 5.0 ms, Duty Cycle $\leq 10\%$.

Measurement made with thermocouple contacting the bottom insulated mounting surface of the package (in a location beneath the die), the device mounted on a heatsink with thermal grease applied at a mounting torque of 6 to 8•lbs.

■ ELECTRICAL CHARACTERISTICS ($T_C=25^\circ\text{C}$, unless otherwise noted)

PARAMETER	SYMBOL	TEST CONDITIONS	MIN	TYP	MAX	UNIT
Collector-Emitter Sustaining Voltage	$V_{CEO(SUS)}$	$I_C=10\text{mA}, I_B=0$	400			V
Collector Cutoff Current	I_{CBO}	$V_{CES}=700\text{V}$			0.1	mA
		$V_{CES}=700\text{V}, T_C=125^\circ\text{C}$			1.0	mA
Emitter Cutoff Current	I_{EBO}	$V_{EB}=9.0\text{V}, I_C=0$			100	μA
DC Current Gain	h_{FE1}	$I_C=2.0\text{A}, V_{CE}=5.0\text{V}$	8.0		40	
	h_{FE2}	$I_C=5.0\text{A}, V_{CE}=5.0\text{V}$	5.0		30	
Collector-Emitter Saturation Voltage	$V_{CE(SAT)}$	$I_C=2.0\text{A}, I_B=0.4\text{A}$			1.0	V
		$I_C=5.0\text{A}, I_B=1.0\text{A}$			2.0	V
		$I_C=8.0\text{A}, I_B=2.0\text{A}$			3.0	V
		$I_C=5.0\text{A}, I_B=1.0\text{A}, T_C=100^\circ\text{C}$			3.0	V
Base-Emitter Saturation Voltage	$V_{BE(SAT)}$	$I_C=2.0\text{A}, I_B=0.4\text{A}$			1.2	V
		$I_C=5.0\text{A}, I_B=1.0\text{A}$			1.6	V
		$I_C=5.0\text{A}, I_B=1.0\text{A}, T_C=100^\circ\text{C}$			1.5	V
Current-Gain-Bandwidth Product	f_T	$I_C=500\text{mA}, V_{CE}=10\text{V}, f=1.0\text{MHz}$	4.0	14		MHz
Output Capacitance	C_{ob}	$V_{CB}=10\text{V}, I_E=0, f=0.1\text{MHz}$		80		pF
Resistive Load (Table 1)						
Delay Time	t_D	$V_{CC}=125\text{V}, I_C=5.0\text{A},$ $I_{B1}=I_{B2}=1.0\text{A}, t_p=25\mu\text{s},$ Duty Cycle $\leq 1.0\%$		0.025	0.1	μs
Rise Time	t_R			0.5	1.5	μs
Storage Time	t_S			1.8	3.0	μs
Fall Time	t_F			0.23	0.7	μs

* Pulse Test: Pulse Width $\leq 300\mu\text{s}$, Duty Cycle $\leq 2.0\%$

■ TYPICAL CHARACTERISTICS

Figure 2. Base-Emitter Saturation Voltage

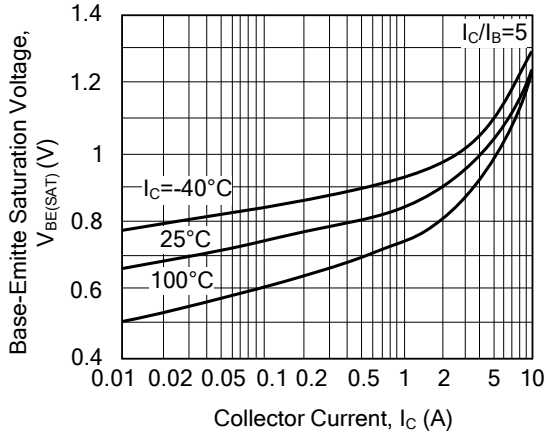

Figure 3. Collector-Emitter Saturation Voltage

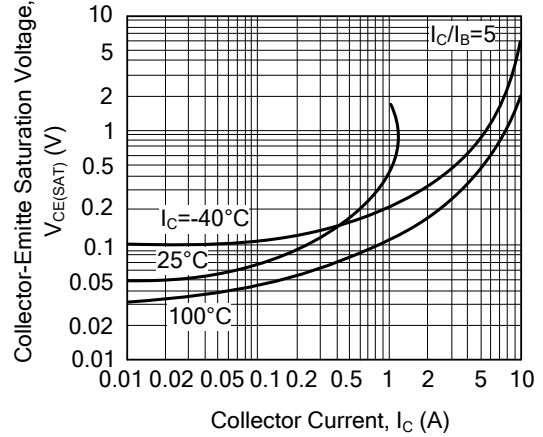

Figure 4. Collector Saturation Region

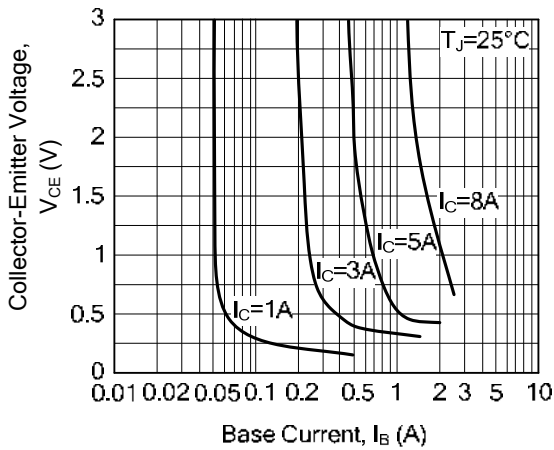

Figure 5. DC Current Gain

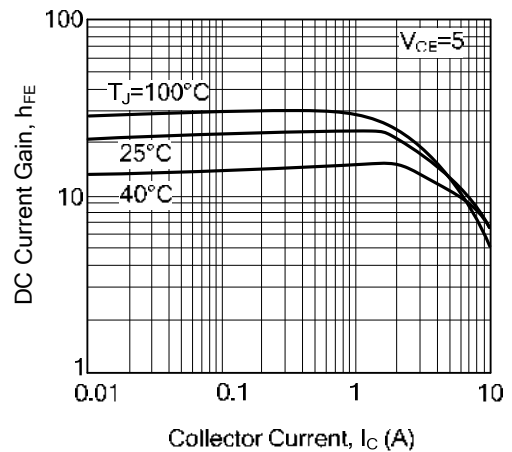

Figure 6. Capacitance

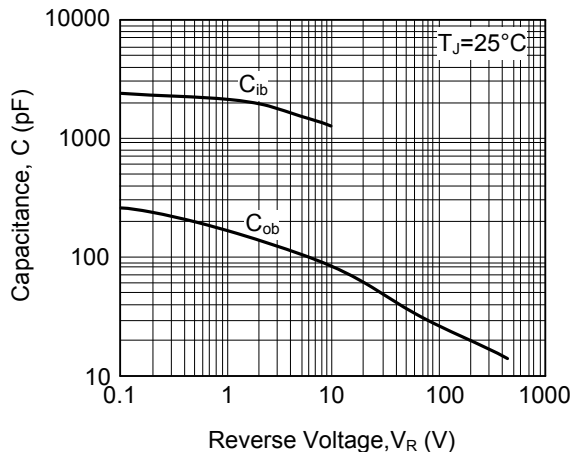
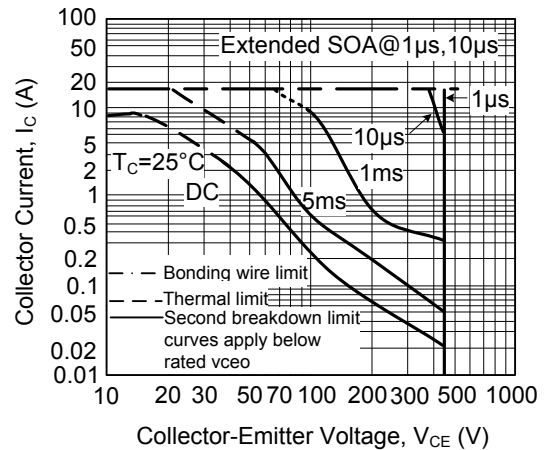

Figure 7. Maximum Forward Bias Safe Operating Area



■ TYPICAL CHARACTERISTICS(Cont.)

Figure 8. Maximum Reverse Bias Switching Safe Operating Area

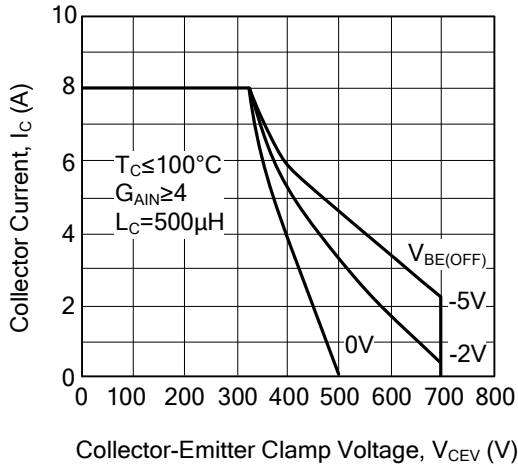

Figure 9. Forward Bias Power Derating

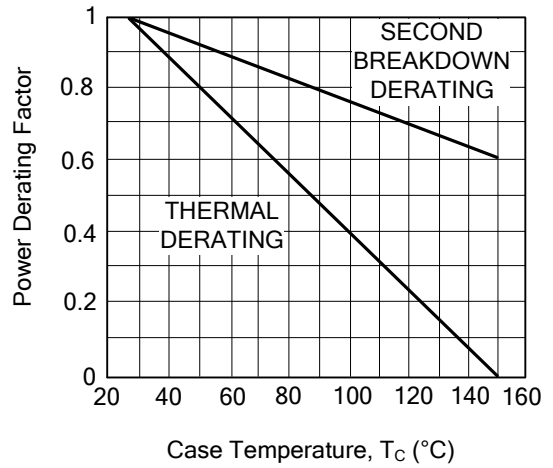

Figure 10. Turn-On Time(Resistive Load)

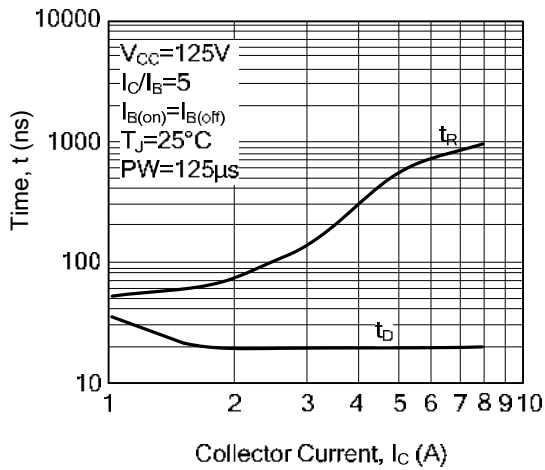
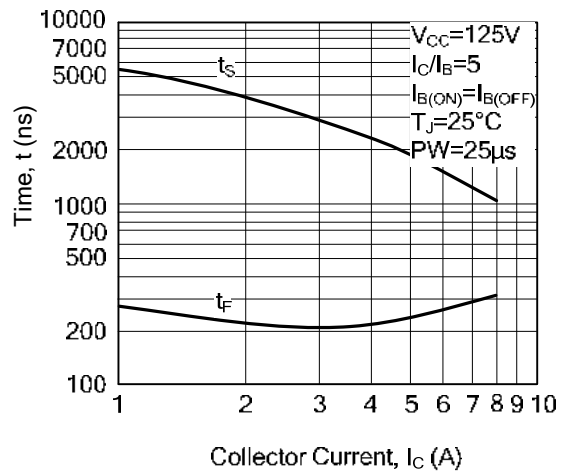
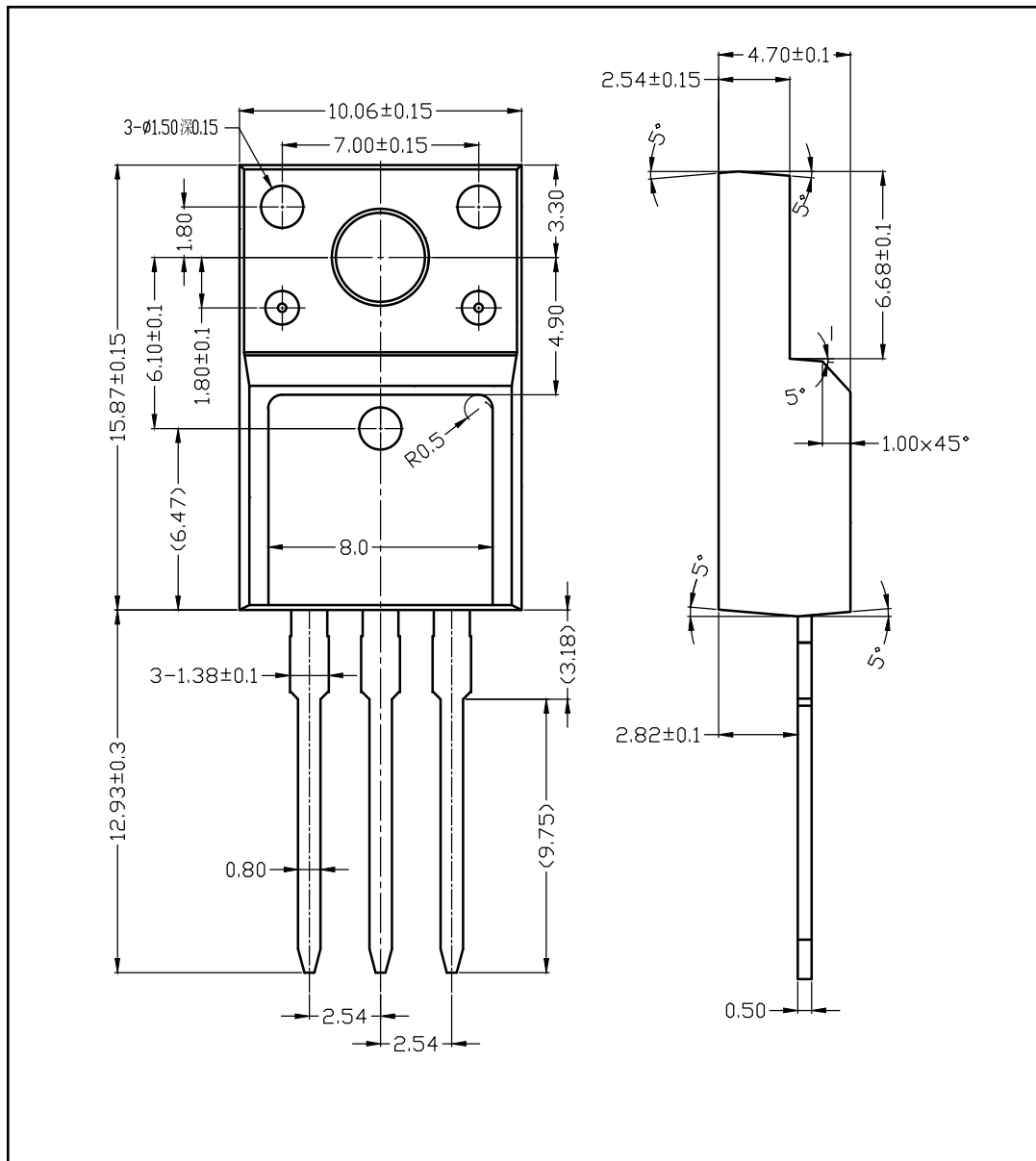

Figure 11. Turn-Off Time(Resistive Load)



■ TO-220F-3L PACKAGE OUTLINE DIMENSIONS



■ TO-220-3L PACKAGE OUTLINE DIMENSIONS

