

<p>NPN型 小功率 贴片高压三极管 NPN High Voltage Transistor SMD</p>	<p>MMBT5551 对应其他工业型号 5551</p>
<ul style="list-style-type: none"> ■ Complementary to 5551 ■ Transistor Polarity: NPN ■ Transistor pinout: BEC ■ SOT-23 Package ■ Marking Code: G1 ■ hFE: 100~200, 200~300 ■ Ideal for Medium Power Amplification and Switching 	

<p style="text-align: center;">Inner circuit</p>  <p style="text-align: center;">SOT-23 内部结构</p>	<p style="text-align: center;">MMBT5551</p>  <p style="text-align: center;">SOT-23 管脚排列</p> <p style="text-align: right;">1. Base 2. Emitter 3. Collector</p>	<p style="text-align: center;">元件标识 (打印)</p>  <p style="text-align: center;">DEVICE MARKING:</p>
---	--	---

■ CLASSIFICATION OF hFE

RANK	L	H
RANGE	100~200	200~300

■ MAXIMUM RATINGS

Symbol	Parameter	Value	Unit
V_{CBO}	Collector-Base Voltage	180	V
V_{CEO}	Collector-Emitter Voltage	160	V
V_{EBO}	Emitter-Base Voltage	6	V
I_C	Collector Current -Continuous	600	mA
P_C	Collector Dissipation	350	mW
T_J, T_{stg}	Operation Junction and Storage Temperature Range	-55~+150	°C

■ ELECTRICAL CHARACTERISTICS ($T_A = 25^\circ\text{C}$, unless otherwise specified)

PARAMETER	SYMBOL	TEST CONDITIONS	MIN	TYP	MAX	UNIT
Collector-Base Breakdown Voltage	V_{CBO}	$I_C = 100\mu\text{A}, I_E = 0$	180			V
Collector-Emitter Breakdown Voltage	V_{CEO}	$I_C = 1\text{mA}, I_B = 0$	160			V
Emitter-Base Breakdown Voltage	V_{EBO}	$I_E = 10\mu\text{A}, I_C = 0$	6			V
Collector Cut-off Current	I_{CBO}	$V_{CB} = 120\text{V}, I_E = 0$			50	nA
Emitter Cut-off Current	I_{EBO}	$V_{BE} = 4\text{V}, I_C = 0$			50	nA
DC Current Gain(note)	h_{FE}	$V_{CE} = 5\text{V}, I_C = 1\text{mA}$	80			
		$V_{CE} = 5\text{V}, I_C = 10\text{mA}$	80	160	400	
		$V_{CE} = 5\text{V}, I_C = 50\text{mA}$	80			
Collector-Emitter Saturation Voltage	$V_{CE(SAT)}$	$I_C = 10\text{mA}, I_B = 1\text{mA}$			0.15	V
		$I_C = 50\text{mA}, I_B = 5\text{mA}$			0.2	V
Base-Emitter Saturation Voltage	$V_{BE(SAT)}$	$I_C = 10\text{mA}, I_B = 1\text{mA}$			1	V
		$I_C = 50\text{mA}, I_B = 5\text{mA}$			1	V
Current Gain Bandwidth Product	f_T	$V_{CE} = 10\text{V}, I_C = 10\text{mA}, f = 100\text{MHz}$	100		300	MHz
Output Capacitance	C_{ob}	$V_{CB} = 10\text{V}, I_E = 0, f = 1\text{MHz}$			6.0	pF
Noise Figure	NF	$I_C = 0.25\text{mA}, V_{CE} = 5\text{V}$ $R_S = 1\text{k}\Omega, f = 10\text{Hz} \sim 15.7\text{kHz}$			8	dB

 Note: Pulse test: $PW < 300\mu\text{s}$, Duty Cycle $< 2\%$

■ TYPICAL CHARACTERISTICS

Fig.1 Collector Output Capacitance

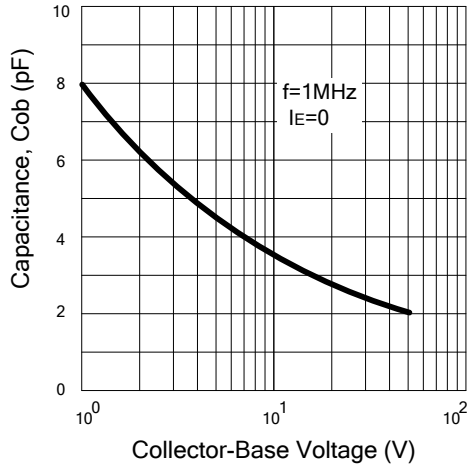

Fig.2 DC Current Gain

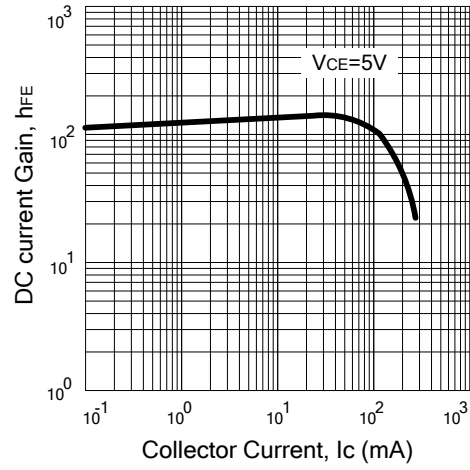

Fig.3 Base-Emitter on Voltage

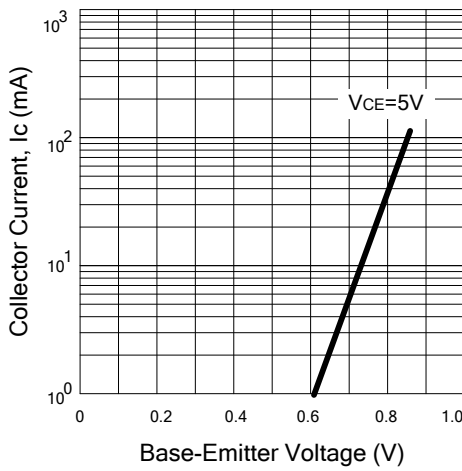

Fig.4 Saturation Voltage

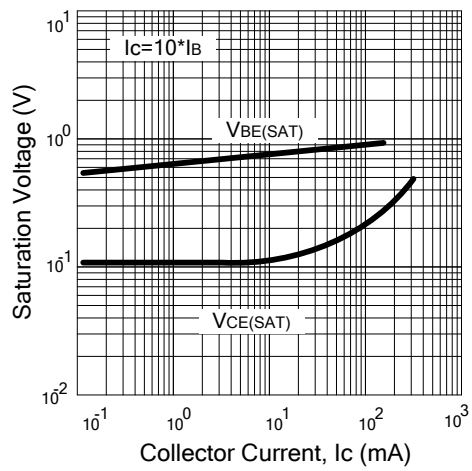
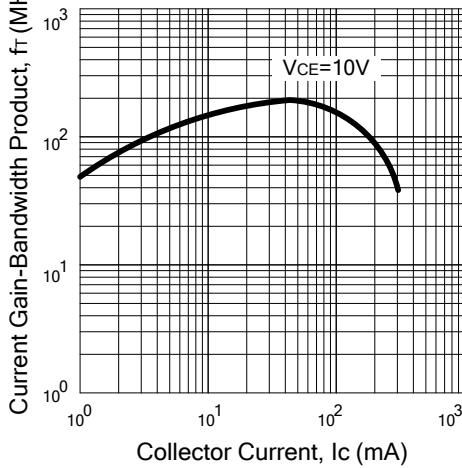
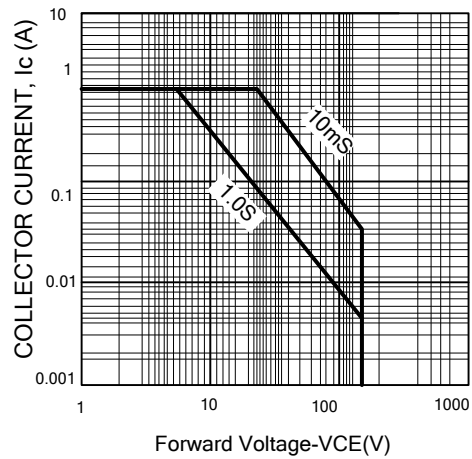

Fig.5 Current Gain-Bandwidth Product



SAFE OPERATING AREA



■ DIMENSION

单位 (UNIT) : mm

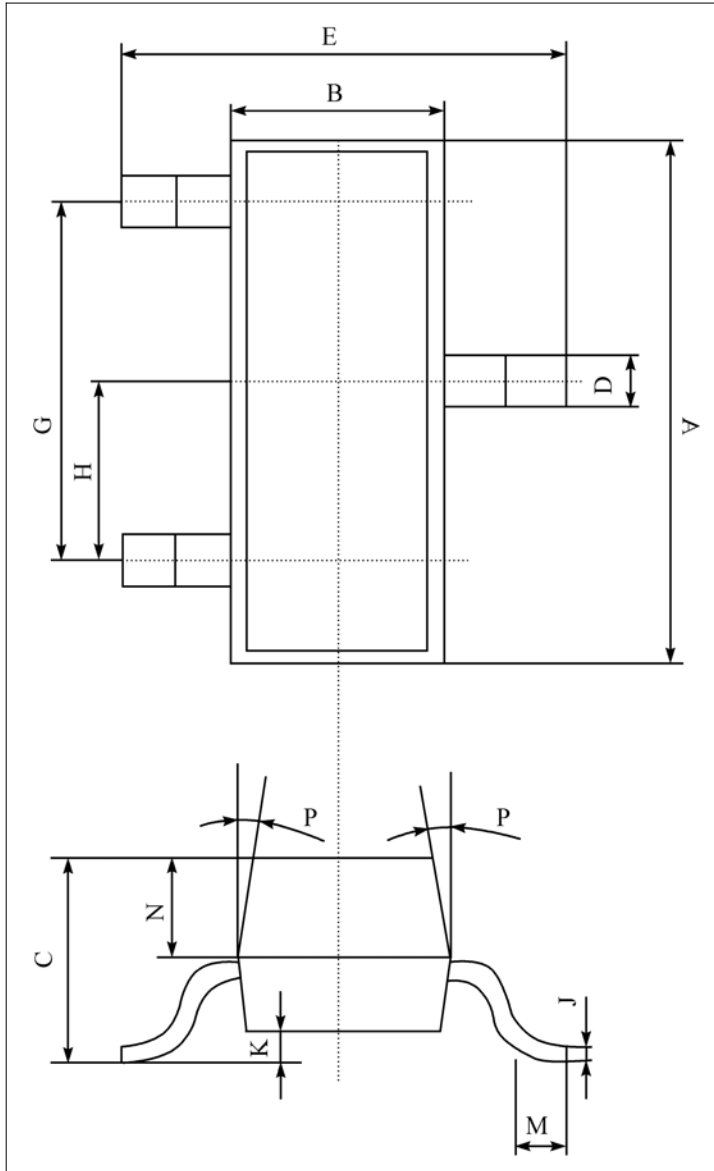

序号	数值及公差
A	2.90±0.10
B	1.30±0.10
C	1.00±0.10
D	0.40±0.10
E	2.40±0.20
G	1.90±0.10
H	0.95±0.05
J	0.13±0.05
K	0.00-0.10
M	≥0.20
N	0.60±0.10
P	7±2°

Packing
SOT-23 包装规格
SMD片式表面贴封装
包装方式: 载带卷盘包装
Tape & Reel, 3Kpcs/Reel
每卷数量3000只 (3Kpcs/Reel)
每盒数量45000只 (45Kpcs/BOX)
每箱数量180000只 (180Kpcs/Cartons)

SOT-23 Tape and reel

SOT-23 Embossed Carrier Tape

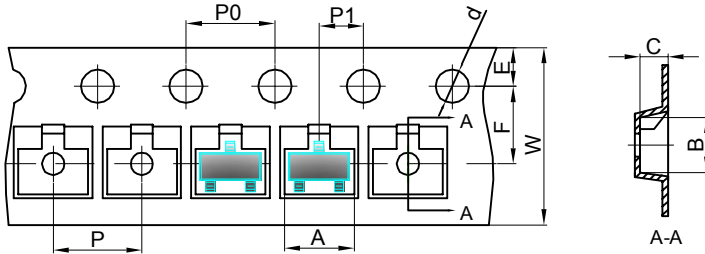

Dimensions are in millimeter										
Pkg type	A	B	C	d	E	F	P0	P	P1	W
SOT-23	3.15	2.77	1.22	Ø1.50	1.75	3.50	4.00	4.00	2.00	8.00

SOT-23 Tape Leader and Trailer

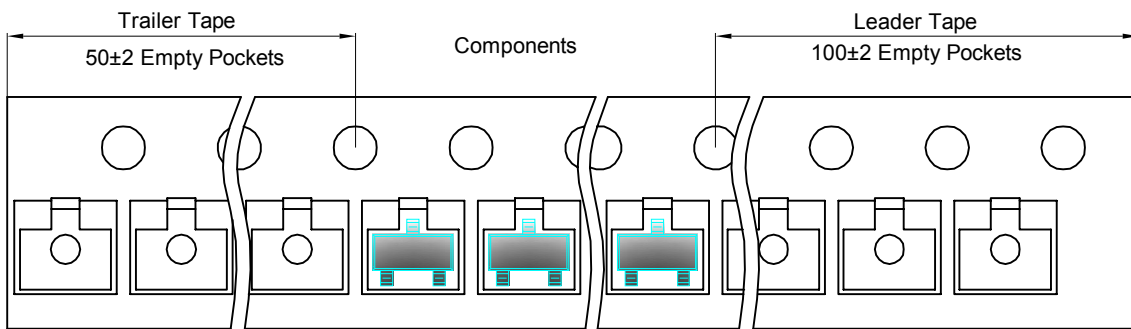

SOT-23 Reel

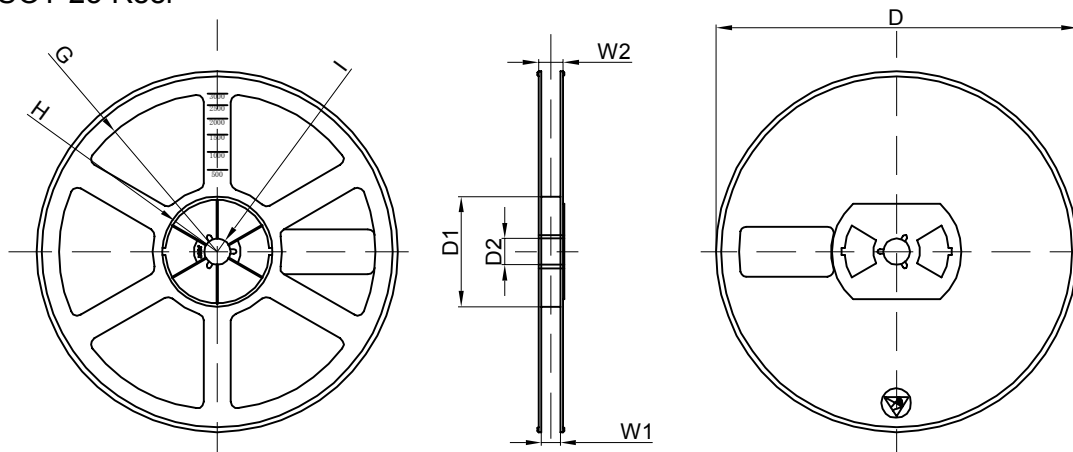

Dimensions are in millimeter								
Reel Option	D	D1	D2	G	H	I	W1	W2
7" Dia	Ø178.00	54.40	13.00	R78.00	R25.60	R6.50	9.50	12.30

REEL	Reel Size	Box	Box Size(mm)	Carton	Carton Size(mm)	G.W.(kg)
3000 pcs	7 inch	45,000 pcs	192×192×193	180,000 pcs	404×404×214	