

■ PRODUCT CHARACTERISTICS

|                |       |
|----------------|-------|
| VR(@IC=0.5mA)  | 45V   |
| VF(Typ@IF=10A) | 0.58V |
| IR(@VR=45V)    | 50uA  |
| ID             | 20A   |

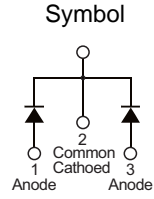

■ MECHANICAL CHARACTERISTICS

- \* Case: epoxy, molded
- \* Finish: all external surfaces corrosion resistant and terminal
- \* Leads are readily solderable
- \* Leads temperature for soldering purposes:  
260°C Max for 10 seconds

■ FEATURES

- \* Guard ring for stress protection
- \* Low forward voltage
- \* Low power loss/high efficiency
- \* High surge capacity
- \* Low stored charge majority carrier conduction
- \* Pb free package are available

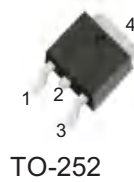

■ ORDER INFORMATION

| Order codes  |          | Package | Packing         |
|--------------|----------|---------|-----------------|
| Halogen-free | Halogen  |         |                 |
| N/A          | MOT2045C | TO-251  | 70pieces/Tube   |
| N/A          | MOT2045D | TO-252  | 2500pieces/Reel |

■ MAXIMUM RATINGS (Each diode leg)

| Parameter  | Symbol         | Value        | Unit |
|--|----------------|--------------|------|
| Peak repetitive reverse voltage  | $V_{RRM}$      | 45           | V    |
| Average rectified output current   | Total          | 20           | A    |
|  | Per leg        | 10           | A    |
| Non-repetitive peak forward surge current 8.3ms single half sine-wave superimposed on reate load | $I_{FSM}$      | 200          | A    |
| Operating and storage temperature range  | $T_J, T_{STG}$ | -55 to + 175 | °C   |

■ ELECTRICAL CHARACTERISTICS

| Parameter                       | Symbol | Conditions                  | Min | Typ  | Max  | Unit |
|---------------------------------|--------|-----------------------------|-----|------|------|------|
| Peak repetitive reverse voltage | $B_V$  | $I_C=0.5mA, T_J=25^\circ C$ | 45  | -    | -    | V    |
| Forward voltage drop            | $V_F$  | $I_F=10A, T_J=25^\circ C$   | -   | 0.58 | 0.63 | V    |
| Leakage current                 | $I_R$  | $V_R=45V, T_J=25^\circ C$   | -   | -    | 0.05 | mA   |
|                                 |        | $V_R=45V, T_J=125^\circ C$  | -   | -    | 6    |      |

■ TYPICAL CHARACTERISTICS

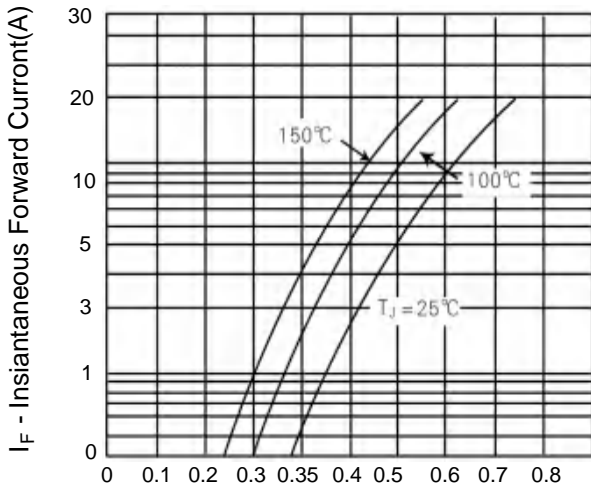

Figure 1. Typical Forward Voltage Per Diode

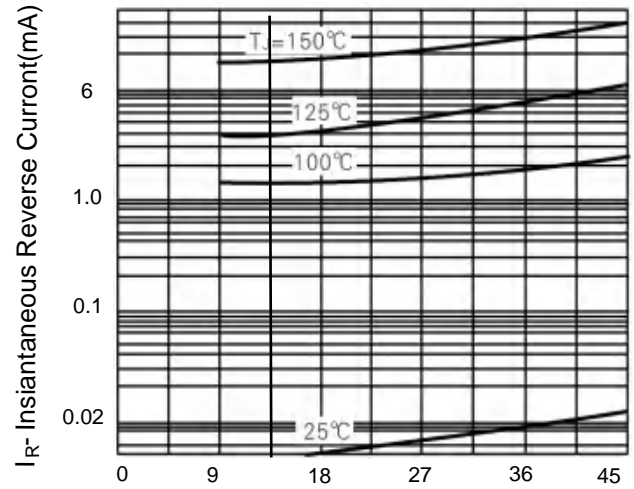
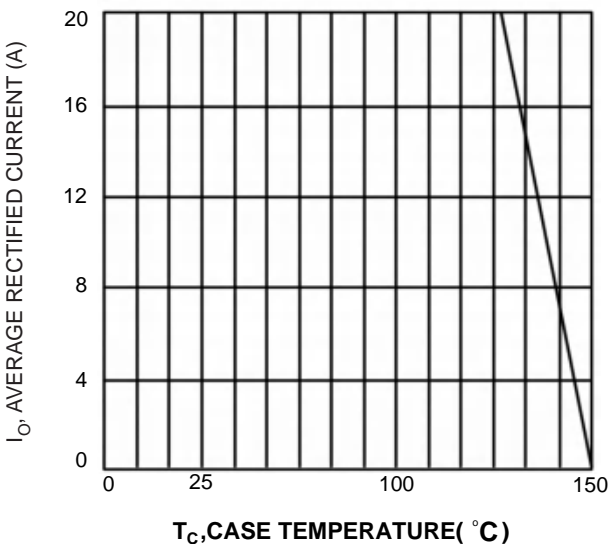
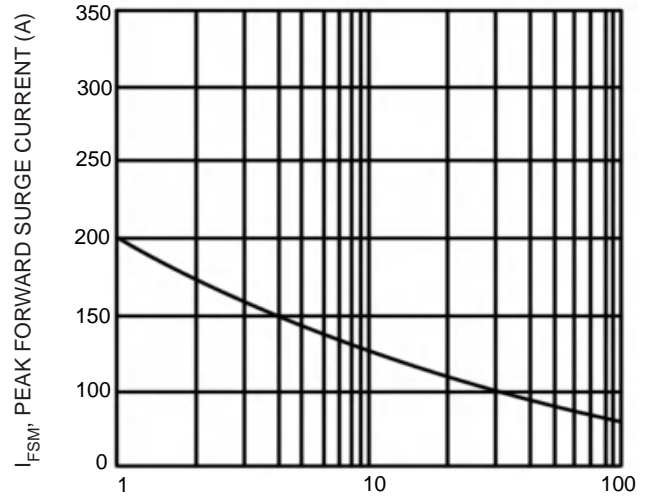

Figure 2. Typical Reverse Current Per Diode



$T_C$ , CASE TEMPERATURE ( $^\circ\text{C}$ )  
Fig.3 Forward Current Derating Curve



NUMBER OF CYCLES AT 60HZ  
Fig.4 Max Non-Repetitive Surge Current

■ TO-251 PACKAGE OUTLINE DIMENSIONS

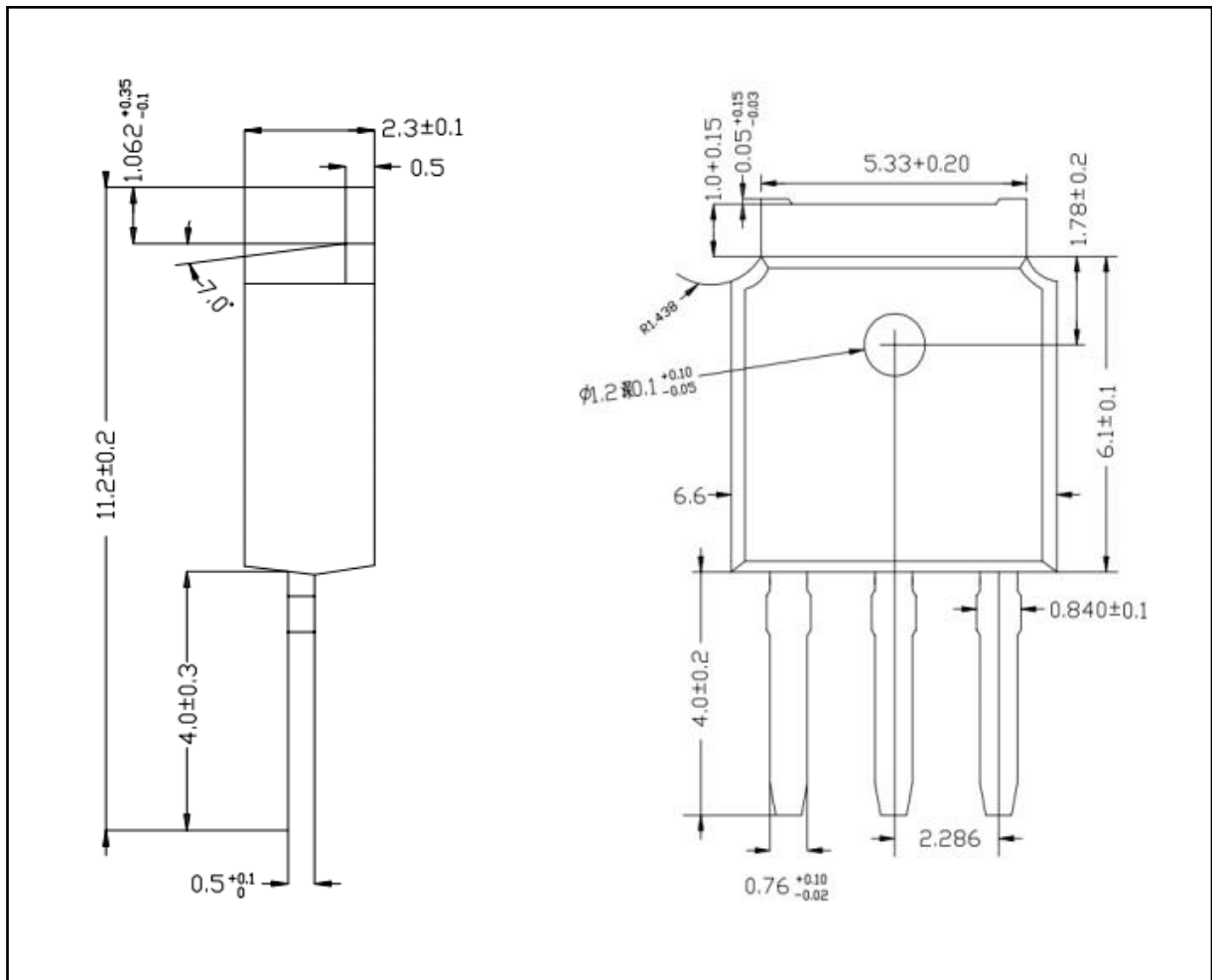

■ TO-252 PACKAGE OUTLINE DIMENSIONS

