

■ PRODUCT CHARACTERISTICS

| | |
|----------------|-------|
| VR(@IC=0.5mA) | 100V |
| VF(Typ@IF=10A) | 0.79V |
| IR(@VR=100V) | 50uA |
| ID | 20A |

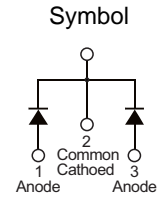

■ MECHANICAL CHARACTERISTICS

- * Case: epoxy,molded
- * Finish:all external surfaces corrosion resistant and terminal
- * Leads are readily solderable
- * Leads temperature for soldering purposes:
260°C Max for 10 seconds

■ FEATURES

- * Guard ring for stress protection
- * Low forward voltage
- * Low power loss/high efficiency
- * High surge capacity
- * Low stored charge majority carrier conduction
- * Pb free package are available

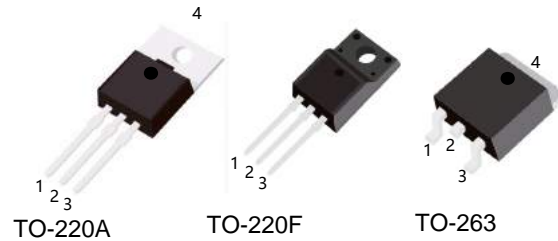

■ ORDER INFORMATION

| Order codes | | Package | Packing |
|--------------|-----------|---------|----------------|
| Halogen-free | Halogen | | |
| N/A | MBR20100A | TO-220 | 50pieces/Tube |
| N/A | MBR20100F | TO-220F | 50pieces/Tube |
| N/A | MBR20100E | TO-263 | 800pieces/Reel |

■ MAXIMUM RATINGS (Each diode leg)

| Parameter | Symbol | Value | Unit |
|--|----------------|--------------|------|
| Peak repetitive reverse voltage | V_{RRM} | 100 | V |
| Average rectified output current | Total | 20 | A |
| | Per leg | 10 | A |
| Non-repetitive peak forward surge current 8.3ms single half sine-wave superimposed on reate load | I_{FSM} | 200 | A |
| Operating and storage temperature range | T_J, T_{STG} | -55 to + 175 | °C |

■ ELECTRICAL CHARACTERISTICS

| Parameter | Symbol | Conditions | Min | Typ | Max | Unit |
|---------------------------------|--------|-----------------------------|-----|------|------|------|
| Peak repetitive reverse voltage | B_V | $I_C=0.5mA, T_J=25^\circ C$ | 100 | - | - | V |
| Forward voltage drop | V_F | $I_F=10A, T_J=25^\circ C$ | - | 0.79 | 0.85 | V |
| Leakage current | I_R | $V_R=100V, T_J=25^\circ C$ | - | - | 0.05 | mA |
| | | $V_R=100V, T_J=125^\circ C$ | - | - | 6 | |

■ TYPICAL CHARACTERISTICS

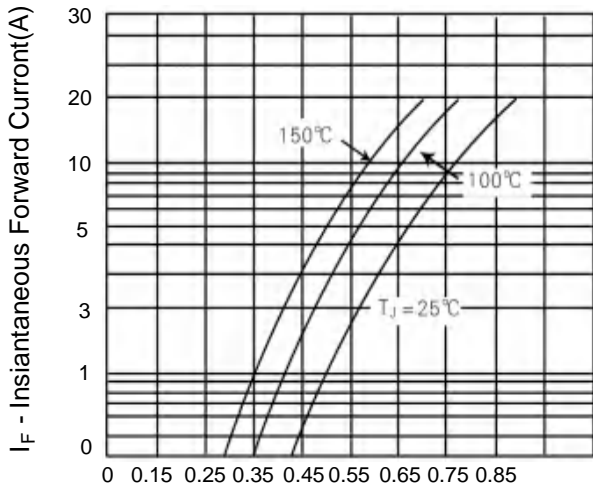

Figure 1. Typical Forward Voltage Per Diode

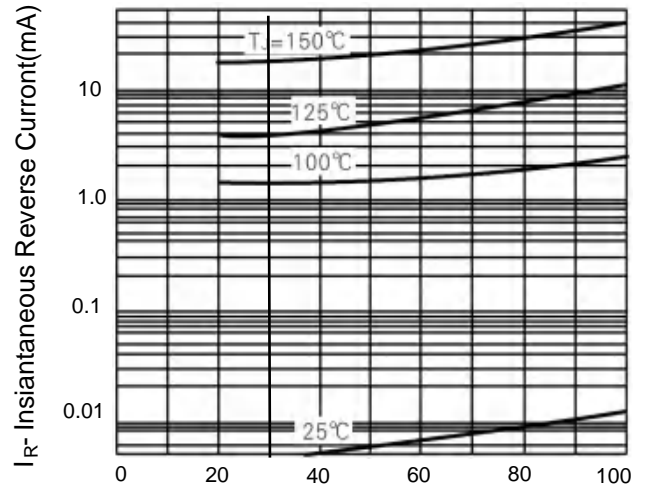
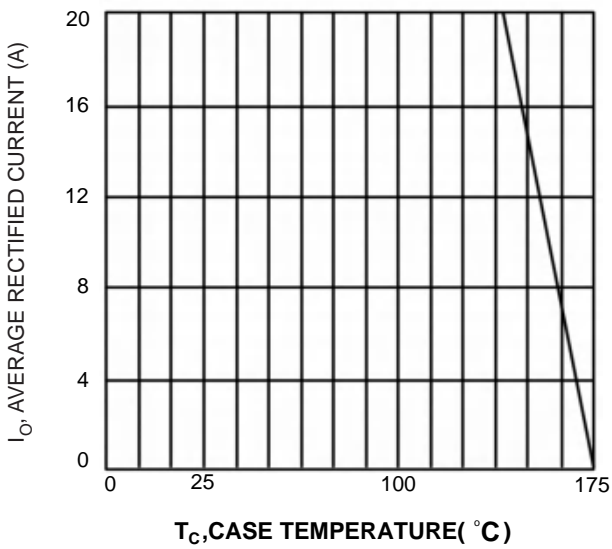
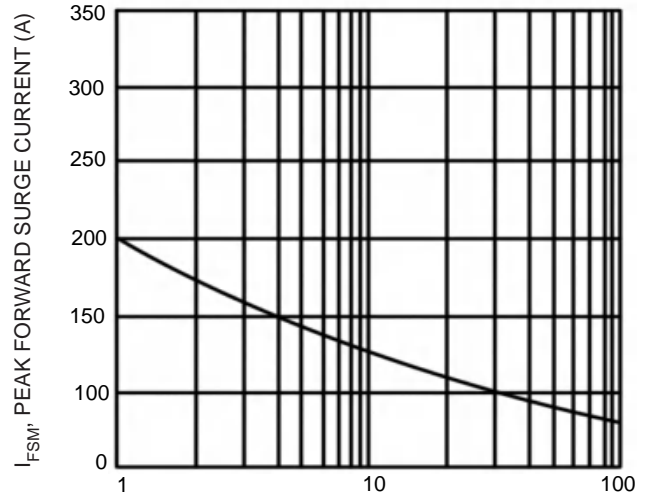

Figure 2. Typical Reverse Current Per Diode



T_C , CASE TEMPERATURE (°C)
 Fig.3 Forward Current Derating Curve



NUMBER OF CYCLES AT 60HZ
 Fig.4 Max Non-Repetitive Surge Current

■ TO-220F PACKAGE OUTLINE DIMENSIONS

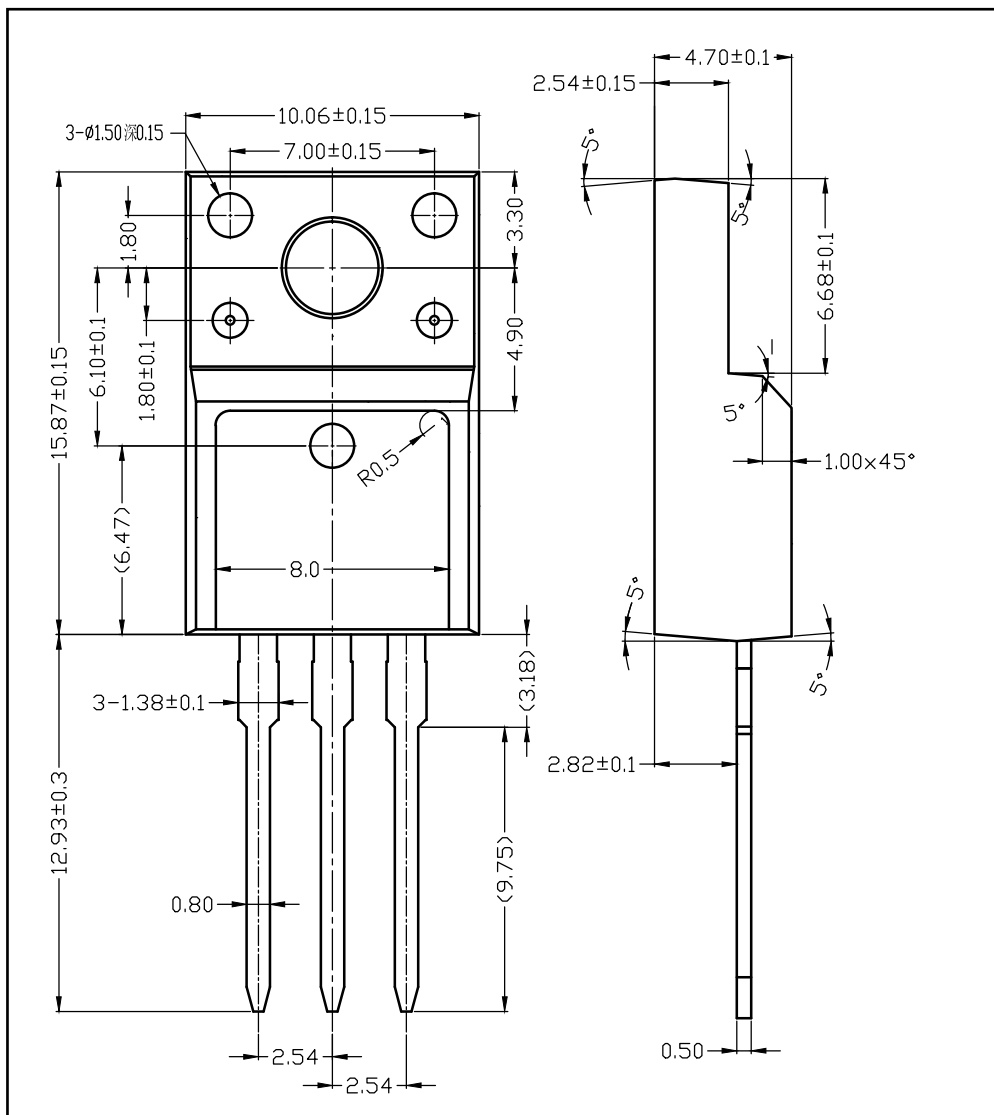

■ TO-220 PACKAGE OUTLINE DIMENSIONS

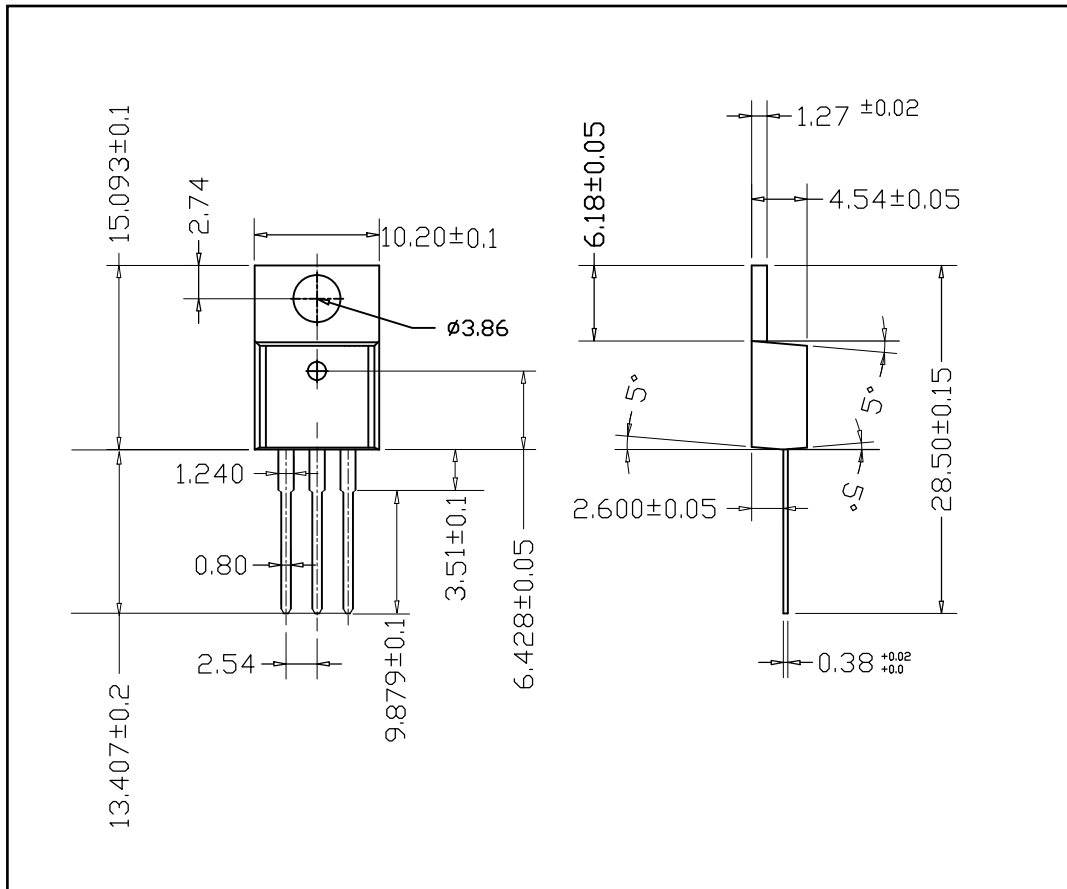

■ TO-263 PACKAGE OUTLINE DIMENSIONS

