

# TL750M, TL751M SERIES LOW-DROPOUT VOLTAGE REGULATORS

SLVS021H – JANUARY 1988 – REVISED JANUARY 2000

- Very Low Dropout Voltage, Less Than 0.6 V at 750 mA
- Low Quiescent Current
- TTL- and CMOS-Compatible Enable on TL751M Series
- 60-V Load-Dump Protection
- Overvoltage Protection
- Internal Thermal Overload Protection
- Internal Overcurrent-Limiting Circuitry

## description

The TL750M and TL751M series are low-dropout positive voltage regulators specifically designed for battery-powered systems. The TL750M and TL751M series incorporate onboard overvoltage and current-limiting protection circuitry to protect the devices and the regulated system. Both series are fully protected against 60-V load-dump and reverse-battery conditions. Extremely low quiescent current, even during full-load conditions, makes the TL750M and TL751M series ideal for standby power systems.

The TL750M and TL751M series offers 5-V, 8-V, 10-V, and 12-V options. The TL751M series has the addition of an enable (ENABLE) input. The ENABLE input gives the designer complete control over power up, allowing sequential power up or emergency shutdown. When ENABLE is high, the regulator output is placed in the high-impedance state. The ENABLE input is TTL- and CMOS-compatible.

The TL750MxxC and TL751MxxC are characterized for operation over the virtual junction temperature range 0°C to 125°C.

### AVAILABLE OPTIONS

T <sub>J</sub>	V <sub>O</sub> TYP (V)	PACKAGED DEVICES				CHIP FORM (Y)
		HEAT-SINK MOUNTED (3-PIN) (KC)	PLASTIC FLANGE MOUNT (KTE)	PLASTIC FLANGE MOUNT (KTG)	PLASTIC FLANGE MOUNT (KTP)	
0°C to 125°C	5	TL750M05CKC	TL750M05CKTE	TL751M05CKTG	TL750M05CKTPR	TL750M05Y
	8	TL750M08CKC	TL750M08CKTE	TL751M08CKTG	TL750M08CKTPR	TL750M08Y
	10	TL750M10CKC	TL750M10CKTE	TL751M10CKTG	TL750M10CKTPR	TL750M10Y
	12	TL750M12CKC	TL750M12CKTE	TL751M12CKTG	TL750M12CKTPR	TL750M12Y

The KTE and KTG packages are available taped and reeled. The KTP is only available taped and reeled. Add the suffix R to device type (e.g., TL750M05CKTER). Chip forms are tested at 25°C.



Please be aware that an important notice concerning availability, standard warranty, and use in critical applications of Texas Instruments semiconductor products and disclaimers thereto appears at the end of this data sheet.

PRODUCTION DATA information is current as of publication date. Products conform to specifications per the terms of Texas Instruments standard warranty. Production processing does not necessarily include testing of all parameters.

 **TEXAS  
INSTRUMENTS**

POST OFFICE BOX 655303 • DALLAS, TEXAS 75265

Copyright © 2000, Texas Instruments Incorporated

# TL750M, TL751M SERIES LOW-DROPOUT VOLTAGE REGULATORS

SLVS021H – JANUARY 1988 – REVISED JANUARY 2000

TL750M . . . KC PACKAGE†  
(TOP VIEW)

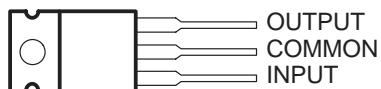

TO-220AB

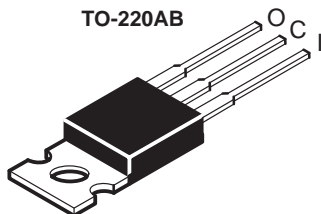

TL750M . . . KTE PACKAGE†  
(TOP VIEW)

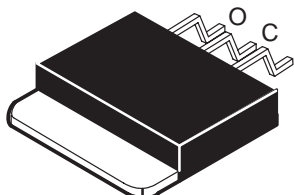
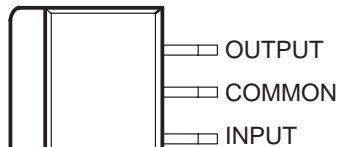

TL750M . . . KTP PACKAGE†  
(TOP VIEW)

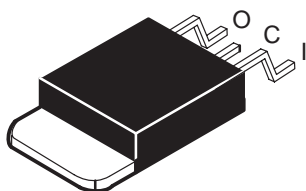
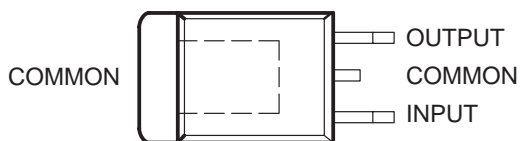

TL751M . . . KTG PACKAGE†  
(TOP VIEW)

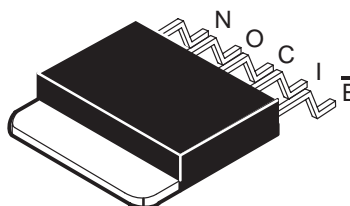
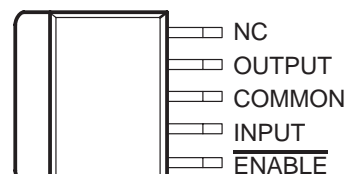

† The common terminal is in electrical contact with the mounting base.  
NC – No internal connection

## TL751Mxx functional block diagram

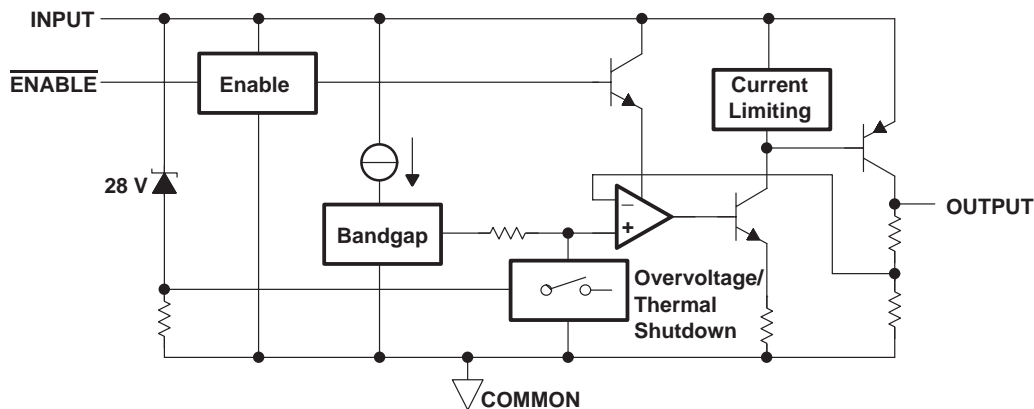

DEVICE COMPONENT COUNT	
Transistors	46
Diodes	14
Resistors	44
Capacitors	4
JFETs	1
Tunnels (emitter R)	2

# TL750M, TL751M SERIES LOW-DROPOUT VOLTAGE REGULATORS

SLVS021H – JANUARY 1988 – REVISED JANUARY 2000

## absolute maximum ratings over virtual junction temperature range (unless otherwise noted)†

Continuous input voltage	26 V
Transient input voltage (see Figure 3)	60 V
Continuous reverse input voltage	-15 V
Transient reverse input voltage: t = 100 ms	-50 V
Package thermal impedance, $\theta_{JA}$ (see Notes 1 and 2):	
KC package	22°C/W
KTE package	23°C/W
KTG package	23°C/W
KTP package	28°C/W
Virtual junction temperature range, $T_J$	0°C to 150°C
Lead temperature 1,6 mm (1/16 inch) from case for 10 seconds	260°C
Storage temperature range, $T_{stg}$	-65°C to 150°C

† Stresses beyond those listed under “absolute maximum ratings” may cause permanent damage to the device. These are stress ratings only, and functional operation of the device at these or any other conditions beyond those indicated under “recommended operating conditions” is not implied. Exposure to absolute-maximum-rated conditions for extended periods may affect device reliability.

- NOTES:
1. Maximum power dissipation is a function of  $T_{J(max)}$ ,  $\theta_{JA}$ , and  $T_A$ . The maximum allowable power dissipation at any allowable ambient temperature is  $P_D = (T_{J(max)} - T_A)/\theta_{JA}$ . Operating at the absolute maximum  $T_J$  of 150°C can impact reliability. Due to variation in individual device electrical characteristics and thermal resistance, the built-in thermal overload protection may be activated at power levels slightly above or below the rated dissipation.
  2. The package thermal impedance is calculated in accordance with JESD 51.

## recommended operating conditions

		MIN	MAX	UNIT
Input voltage range, $V_I$	TL75xM05	6	26	V
	TL75xM08	9	26	
	TL75xM10	11	26	
	TL75xM12	13	26	
High-level $\overline{ENABLE}$ input voltage, $V_{IH}$	TL751Mxx	2	15	V
Low-level $\overline{ENABLE}$ input voltage, $V_{IL}$	TL751Mxx	0	0.8	V
Output current range, $I_O$	TL75xMxxC		750	mA
Operating virtual junction temperature range, $T_J$	TL75xMxxC	0	125	°C

## electrical characteristics, $V_I = 14$ V, $I_O = 300$ mA, $T_J = 25^\circ\text{C}$

PARAMETER	TL751MXXX			UNIT
	MIN	TYP	MAX	
Response time, $\overline{ENABLE}$ to output		50		$\mu\text{s}$



# TL750M, TL751M SERIES LOW-DROPOUT VOLTAGE REGULATORS

SLVS021H – JANUARY 1988 – REVISED JANUARY 2000

electrical characteristics,  $V_I = 14\text{ V}$ ,  $I_O = 300\text{ mA}$ ,  $\overline{\text{ENABLE}}$  at 0 V for TL751M05,  $T_J = 25^\circ\text{C}$  (unless otherwise noted) (see Note 3)

PARAMETER	TEST CONDITIONS	TL750M05C TL751M05C			UNIT
		MIN	TYP	MAX	
Output voltage		4.95	5	5.05	V
	$T_J = 0^\circ\text{C}$ to $125^\circ\text{C}$	4.9		5.1	
Input voltage regulation	$V_I = 9\text{ V}$ to $16\text{ V}$ , $I_O = 250\text{ mA}$		10	25	mV
	$V_I = 6\text{ V}$ to $26\text{ V}$ , $I_O = 250\text{ mA}$		12	50	
Ripple rejection	$V_I = 8\text{ V}$ to $18\text{ V}$ , $f = 120\text{ Hz}$	50	55		dB
Output voltage regulation	$I_O = 5\text{ mA}$ to $750\text{ mA}$		20	50	mV
Dropout voltage	$I_O = 500\text{ mA}$			0.5	V
	$I_O = 750\text{ mA}$			0.6	
Output noise voltage	$f = 10\text{ Hz}$ to $100\text{ kHz}$		500		$\mu\text{V}$
Bias current	$I_O = 750\text{ mA}$		60	75	mA
	$I_O = 10\text{ mA}$			5	
Bias current (TL751M05C and TL751M05Q only)	$\overline{\text{ENABLE}} V_{IH} \geq 2\text{ V}$			200	$\mu\text{A}$

NOTE 3: Pulse-testing techniques maintain the junction temperature as close to the ambient temperature as possible. Thermal effects must be taken into account separately. All characteristics are measured with a 0.1- $\mu\text{F}$  capacitor across the input and a 10- $\mu\text{F}$  tantalum capacitor on the output, with equivalent series resistance within the guidelines shown in Figure 3.

electrical characteristics,  $V_I = 14\text{ V}$ ,  $I_O = 300\text{ mA}$ ,  $\overline{\text{ENABLE}}$  at 0 V for TL751M08,  $T_J = 25^\circ\text{C}$  (unless otherwise noted) (see Note 3)

PARAMETER	TEST CONDITIONS	TL750M08C TL751M08C			UNIT
		MIN	TYP	MAX	
Output voltage		7.92	8	8.08	V
	$T_J = 0^\circ\text{C}$ to $125^\circ\text{C}$	7.84		8.16	
Input voltage regulation	$V_I = 10\text{ V}$ to $17\text{ V}$ , $I_O = 250\text{ mA}$		12	40	mV
	$V_I = 9\text{ V}$ to $26\text{ V}$ , $I_O = 250\text{ mA}$		15	68	
Ripple rejection	$V_I = 11\text{ V}$ to $21\text{ V}$ , $f = 120\text{ Hz}$	50	55		dB
Output voltage regulation	$I_O = 5\text{ mA}$ to $750\text{ mA}$		24	80	mV
Dropout voltage	$I_O = 500\text{ mA}$			0.5	V
	$I_O = 750\text{ mA}$			0.6	
Output noise voltage	$f = 10\text{ Hz}$ to $100\text{ kHz}$		500		$\mu\text{V}$
Bias current	$I_O = 750\text{ mA}$		60	75	mA
	$I_O = 10\text{ mA}$			5	
Bias current (TL751Mxx only)	$\overline{\text{ENABLE}} V_{IH} \geq 2\text{ V}$			200	$\mu\text{A}$

NOTE 3: Pulse-testing techniques maintain the junction temperature as close to the ambient temperature as possible. Thermal effects must be taken into account separately. All characteristics are measured with a 0.1- $\mu\text{F}$  capacitor across the input and a 10- $\mu\text{F}$  tantalum capacitor on the output, with equivalent series resistance within the guidelines shown in Figure 3.



# TL750M, TL751M SERIES LOW-DROPOUT VOLTAGE REGULATORS

SLVS021H – JANUARY 1988 – REVISED JANUARY 2000

electrical characteristics,  $V_I = 14\text{ V}$ ,  $I_O = 300\text{ mA}$ ,  $\overline{\text{ENABLE}}$  at 0 V for TL751M10,  $T_J = 25^\circ\text{C}$  (unless otherwise noted) (see Note 3)

PARAMETER	TEST CONDITIONS	TL750M10C TL751M10C			UNIT
		MIN	TYP	MAX	
Output voltage		9.9	10	10.1	V
	$T_J = 0^\circ\text{C to } 125^\circ\text{C}$	9.8		10.2	
Input voltage regulation	$V_I = 12\text{ V to } 18\text{ V}$ , $I_O = 250\text{ mA}$		15	43	mV
	$V_I = 11\text{ V to } 26\text{ V}$ , $I_O = 250\text{ mA}$		20	75	
Ripple rejection	$V_I = 13\text{ V to } 23\text{ V}$ , $f = 120\text{ Hz}$	50	55		dB
Output voltage regulation	$I_O = 5\text{ mA to } 750\text{ mA}$		30	100	mV
Dropout voltage	$I_O = 500\text{ mA}$			0.5	V
	$I_O = 750\text{ mA}$			0.6	
Output noise voltage	$f = 10\text{ Hz to } 100\text{ kHz}$		1000		$\mu\text{V}$
Bias current	$I_O = 750\text{ mA}$		60	75	mA
	$I_O = 10\text{ mA}$			5	
Bias current (TL751Mxx only)	$\overline{\text{ENABLE}} V_{IH} \geq 2\text{ V}$			200	$\mu\text{A}$

NOTE 3: Pulse-testing techniques maintain the junction temperature as close to the ambient temperature as possible. Thermal effects must be taken into account separately. All characteristics are measured with a 0.1- $\mu\text{F}$  capacitor across the input and a 10- $\mu\text{F}$  tantalum capacitor on the output, with equivalent series resistance within the guidelines shown in Figure 3.

electrical characteristics,  $V_I = 14\text{ V}$ ,  $I_O = 300\text{ mA}$ ,  $\overline{\text{ENABLE}}$  at 0 V for TL751M12,  $T_J = 25^\circ\text{C}$  (unless otherwise noted) (see Note 3)

PARAMETER	TEST CONDITIONS	TL750M12C TL751M12C			UNIT
		MIN	TYP	MAX	
Output voltage		11.88	12	12.12	V
	$T_J = 0^\circ\text{C to } 125^\circ\text{C}$	11.76		12.24	
Input voltage regulation	$V_I = 14\text{ V to } 19\text{ V}$ , $I_O = 250\text{ mA}$		15	43	mV
	$V_I = 13\text{ V to } 26\text{ V}$ , $I_O = 250\text{ mA}$		20	78	
Ripple rejection	$V_I = 13\text{ V to } 23\text{ V}$ , $f = 120\text{ Hz}$	50	55		dB
Output voltage regulation	$I_O = 5\text{ mA to } 750\text{ mA}$		30	120	mV
Dropout voltage	$I_O = 500\text{ mA}$			0.5	V
	$I_O = 750\text{ mA}$			0.6	
Output noise voltage	$f = 10\text{ Hz to } 100\text{ kHz}$		1000		$\mu\text{V}$
Bias current	$I_O = 750\text{ mA}$		60	75	mA
	$I_O = 10\text{ mA}$			5	
Bias current (TL751Mxx only)	$\overline{\text{ENABLE}} V_{IH} \geq 2\text{ V}$			200	$\mu\text{A}$

NOTE 3: Pulse-testing techniques maintain the junction temperature as close to the ambient temperature as possible. Thermal effects must be taken into account separately. All characteristics are measured with a 0.1- $\mu\text{F}$  capacitor across the input and a 10- $\mu\text{F}$  tantalum capacitor on the output, with equivalent series resistance within the guidelines shown in Figure 3.



# TL750M, TL751M SERIES LOW-DROPOUT VOLTAGE REGULATORS

SLVS021H – JANUARY 1988 – REVISED JANUARY 2000

**electrical characteristics,  $V_I = 14\text{ V}$ ,  $I_O = 300\text{ mA}$ ,  $\overline{\text{ENABLE}}$  at  $0\text{ V}$ ,  $T_J = 25^\circ\text{C}$  (unless otherwise noted) (see Note 3)**

PARAMETER	TEST CONDITIONS	TL750M05Y			UNIT
		MIN	TYP	MAX	
Output voltage			5		V
Input voltage regulation	$V_I = 9\text{ V to }16\text{ V}$ , $I_O = 250\text{ mA}$		10		mV
	$V_I = 6\text{ V to }26\text{ V}$ , $I_O = 250\text{ mA}$		12		
Ripple rejection	$V_I = 8\text{ V to }18\text{ V}$ , $f = 120\text{ Hz}$		55		dB
Output voltage regulation	$I_O = 5\text{ mA to }750\text{ mA}$		20		mV
Output noise voltage	$f = 10\text{ Hz to }100\text{ kHz}$		500		$\mu\text{V}$
Bias current	$I_O = 750\text{ mA}$		60		mA

NOTE 3: Pulse-testing techniques maintain the junction temperature as close to the ambient temperature as possible. Thermal effects must be taken into account separately. All characteristics are measured with a 0.1- $\mu\text{F}$  capacitor across the input and a 10- $\mu\text{F}$  tantalum capacitor on the output, with equivalent series resistance within the guidelines shown in Figure 3.

**electrical characteristics,  $V_I = 14\text{ V}$ ,  $I_O = 300\text{ mA}$ ,  $\overline{\text{ENABLE}}$  at  $0\text{ V}$ ,  $T_J = 25^\circ\text{C}$  (unless otherwise noted) (see Note 3)**

PARAMETER	TEST CONDITIONS	TL750M08Y			UNIT
		MIN	TYP	MAX	
Output voltage			8		V
Input voltage regulation	$V_I = 10\text{ V to }17\text{ V}$ , $I_O = 250\text{ mA}$		12		mV
	$V_I = 9\text{ V to }26\text{ V}$ , $I_O = 250\text{ mA}$		15		
Ripple rejection	$V_I = 11\text{ V to }21\text{ V}$ , $f = 120\text{ Hz}$		55		dB
Output voltage regulation	$I_O = 5\text{ mA to }750\text{ mA}$		24		mV
Output noise voltage	$f = 10\text{ Hz to }100\text{ kHz}$		500		$\mu\text{V}$
Bias current	$I_O = 750\text{ mA}$		60		mA

NOTE 3: Pulse-testing techniques maintain the junction temperature as close to the ambient temperature as possible. Thermal effects must be taken into account separately. All characteristics are measured with a 0.1- $\mu\text{F}$  capacitor across the input and a 10- $\mu\text{F}$  tantalum capacitor on the output, with equivalent series resistance within the guidelines shown in Figure 3.

**electrical characteristics,  $V_I = 14\text{ V}$ ,  $I_O = 300\text{ mA}$ ,  $\overline{\text{ENABLE}}$  at  $0\text{ V}$ ,  $T_J = 25^\circ\text{C}$  (unless otherwise noted) (see Note 3)**

PARAMETER	TEST CONDITIONS	TL750M10Y			UNIT
		MIN	TYP	MAX	
Output voltage			10		V
Input voltage regulation	$V_I = 12\text{ V to }18\text{ V}$ , $I_O = 250\text{ mA}$		15		mV
	$V_I = 11\text{ V to }26\text{ V}$ , $I_O = 250\text{ mA}$		20		
Ripple rejection	$V_I = 13\text{ V to }23\text{ V}$ , $f = 120\text{ Hz}$		55		dB
Output voltage regulation	$I_O = 5\text{ mA to }750\text{ mA}$		30		mV
Output noise voltage	$f = 10\text{ Hz to }100\text{ kHz}$		1000		$\mu\text{V}$
Bias current	$I_O = 750\text{ mA}$		60		mA

NOTE 3: Pulse-testing techniques maintain the junction temperature as close to the ambient temperature as possible. Thermal effects must be taken into account separately. All characteristics are measured with a 0.1- $\mu\text{F}$  capacitor across the input and a 10- $\mu\text{F}$  tantalum capacitor on the output, with equivalent series resistance within the guidelines shown in Figure 3.



# TL750M, TL751M SERIES LOW-DROPOUT VOLTAGE REGULATORS

SLVS021H – JANUARY 1988 – REVISED JANUARY 2000

**TL751M12Y electrical characteristics,  $V_I = 14\text{ V}$ ,  $I_O = 300\text{ mA}$ ,  $\overline{\text{ENABLE}}$  at  $0\text{ V}$ ,  $T_J = 25^\circ\text{C}$  (unless otherwise noted) (see Note 3)**

PARAMETER	TEST CONDITIONS	TL750M12Y			UNIT
		MIN	TYP	MAX	
Output voltage			12		V
Input voltage regulation	$V_I = 14\text{ V to }19\text{ V}$ , $I_O = 250\text{ mA}$		15		mV
	$V_I = 13\text{ V to }26\text{ V}$ , $I_O = 250\text{ mA}$		20		
Ripple rejection	$V_I = 13\text{ V to }23\text{ V}$ , $f = 120\text{ Hz}$		55		dB
Output voltage regulation	$I_O = 5\text{ mA to }750\text{ mA}$		30		mV
Output noise voltage	$f = 10\text{ Hz to }100\text{ kHz}$		1000		$\mu\text{V}$
Bias current	$I_O = 750\text{ mA}$		60		mA

NOTE 3: Pulse-testing techniques maintain the junction temperature as close to the ambient temperature as possible. Thermal effects must be taken into account separately. All characteristics are measured with a  $0.1\text{-}\mu\text{F}$  capacitor across the input and a  $10\text{-}\mu\text{F}$  tantalum capacitor on the output, with equivalent series resistance within the guidelines shown in Figure 3.

## PARAMETER MEASUREMENT INFORMATION

The TL751Mxx is a low-dropout regulator. This means that the capacitance loading is important to the performance of the regulator because it is a vital part of the control loop. The capacitor value and the equivalent series resistance (ESR) both affect the control loop and must be defined for the load range and the temperature range. Figures 1 and 2 can establish the capacitance value and ESR range for the best regulator performance.

Figure 1 shows the recommended range of ESR for a given load with a  $10\text{-}\mu\text{F}$  capacitor on the output. This figure also shows a maximum ESR limit of  $2\ \Omega$  and a load-dependent minimum ESR limit.

For applications with varying loads, the lightest load condition should be chosen because it is the worst case. Figure 2 shows the relationship of the reciprocal of ESR to the square root of the capacitance with a minimum capacitance limit of  $10\ \mu\text{F}$  and a maximum ESR limit of  $2\ \Omega$ . This figure establishes the amount that the minimum ESR limit shown in Figure 1 can be adjusted for different capacitor values. For example, where the minimum load needed is  $200\text{ mA}$ , Figure 2 suggests an ESR range of  $0.8\ \Omega$  to  $2\ \Omega$  for  $10\ \mu\text{F}$ . Figure 2 shows that changing the capacitor from  $10\ \mu\text{F}$  to  $400\ \mu\text{F}$  can change the ESR minimum by greater than  $3/0.5$  (or 6). Therefore, the new minimum ESR value is  $0.8/6$  (or  $0.13\ \Omega$ ). This allows an ESR range of  $0.13\ \Omega$  to  $2\ \Omega$ , achieving an expanded ESR range by using a larger capacitor at the output. For better stability in low-current applications, a small resistance placed in series with the capacitor (see Table 1) is recommended, so that ESRs better approximate those shown in Figures 1 and 2.

# TL750M, TL751M SERIES LOW-DROPOUT VOLTAGE REGULATORS

SLVS021H – JANUARY 1988 – REVISED JANUARY 2000

## PARAMETER MEASUREMENT INFORMATION

Table 1. Compensation for Increased Stability at Low Currents

MANUFACTURER	CAPACITANCE	ESR TYP	PART NUMBER	ADDITIONAL RESISTANCE
AVX	15 $\mu\text{F}$	0.9 $\Omega$	TAJB156M010S	1 $\Omega$
KEMET	33 $\mu\text{F}$	0.6 $\Omega$	T491D336M010AS	0.5 $\Omega$

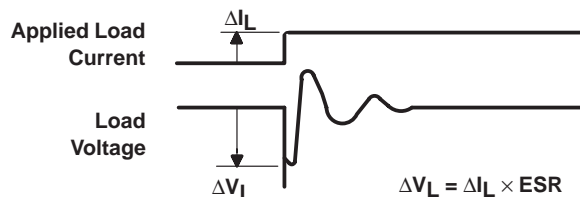

OUTPUT CAPACITOR  
EQUIVALENT SERIES RESISTANCE (ESR)  
vs  
LOAD CURRENT RANGE

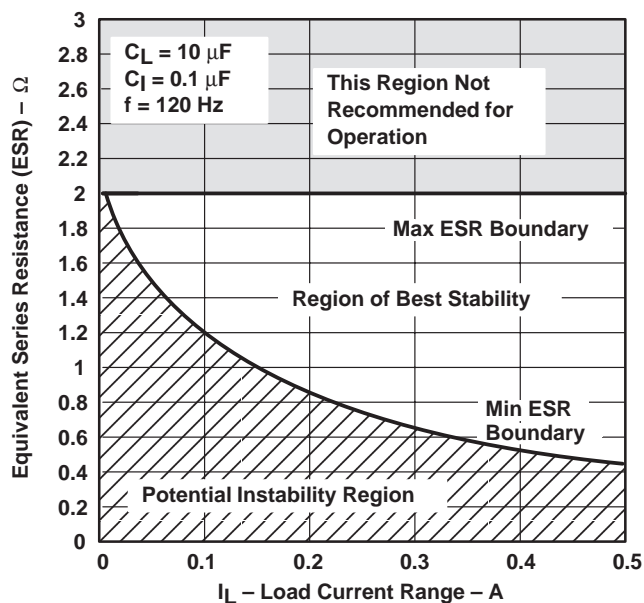

Figure 1

STABILITY  
vs  
EQUIVALENT SERIES RESISTANCE (ESR)

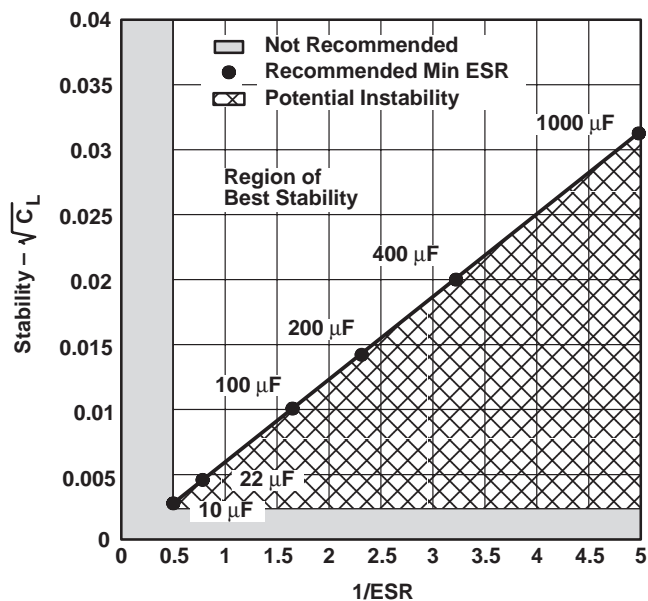

Figure 2



TYPICAL CHARACTERISTICS

Table of Graphs

		FIGURE
Transient input voltage vs Time		3
Output voltage vs Input voltage		4
Input current vs Input voltage	$I_O = 10 \text{ mA}$	5
	$I_O = 100 \text{ mA}$	6
Dropout voltage vs Output current		7
Quiescent current vs Output current		8
Load transient response		9
Line transient response		10

TRANSIENT INPUT VOLTAGE  
vs  
TIME

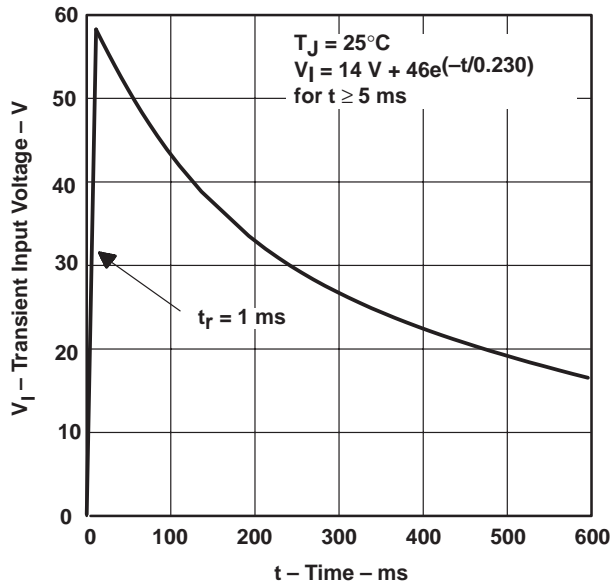

Figure 3

OUTPUT VOLTAGE  
vs  
INPUT VOLTAGE

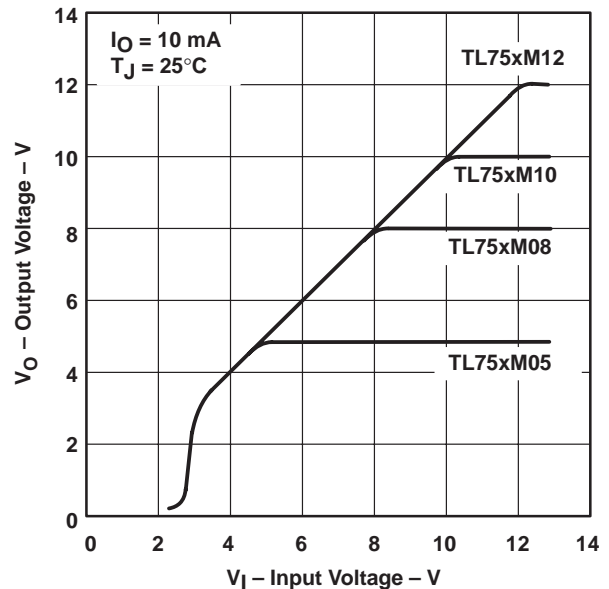
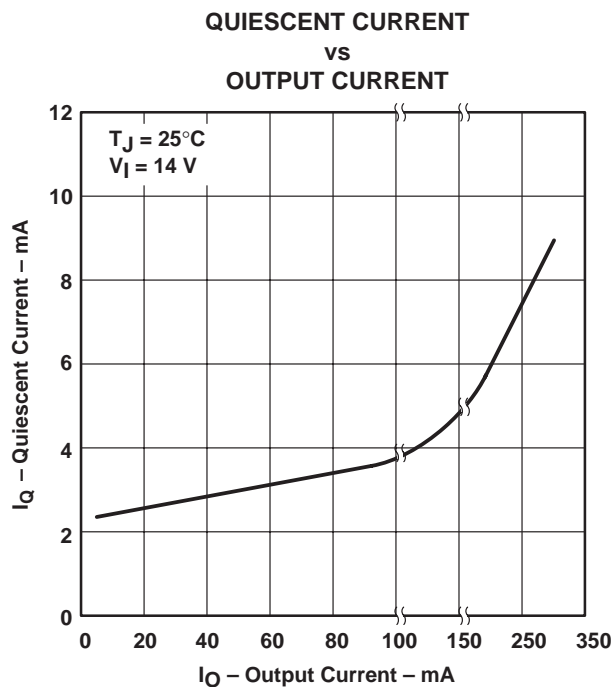
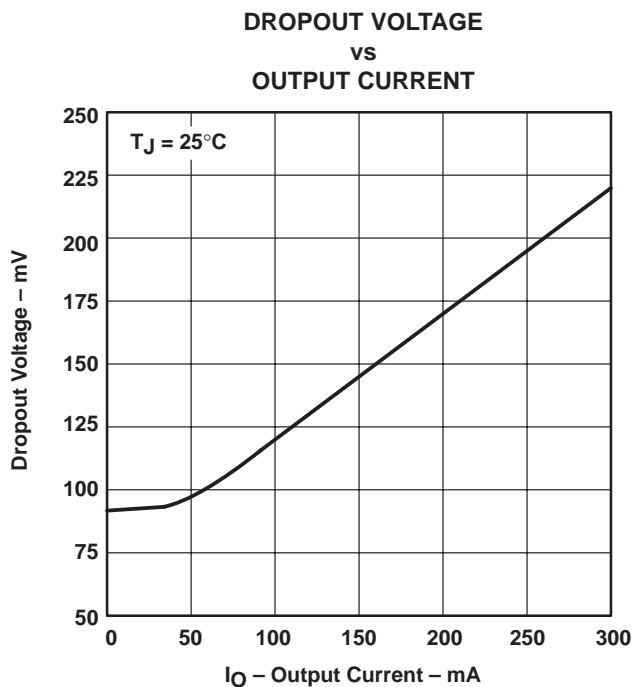
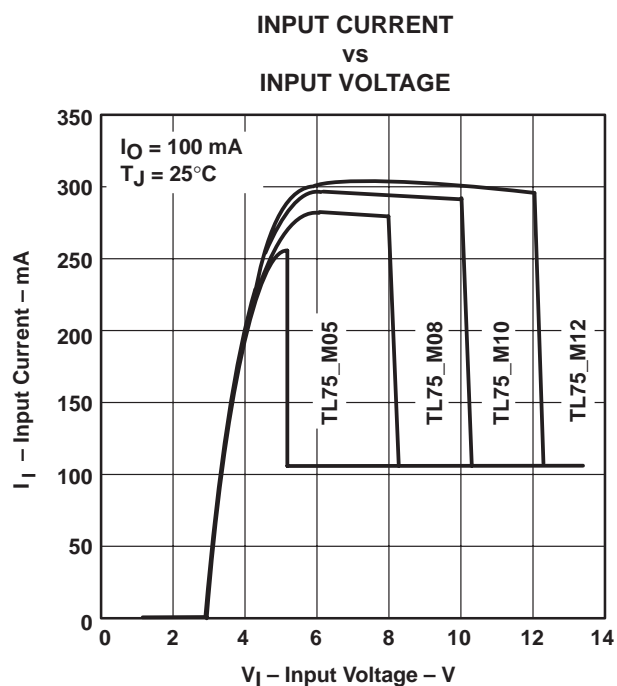
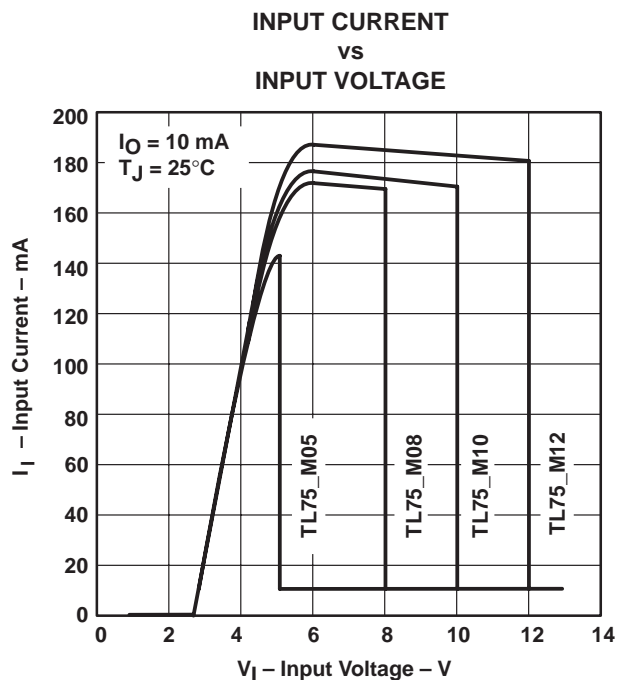

Figure 4

# TL750M, TL751M SERIES LOW-DROPOUT VOLTAGE REGULATORS

SLVS021H – JANUARY 1988 – REVISED JANUARY 2000

## TYPICAL CHARACTERISTICS



TYPICAL CHARACTERISTICS

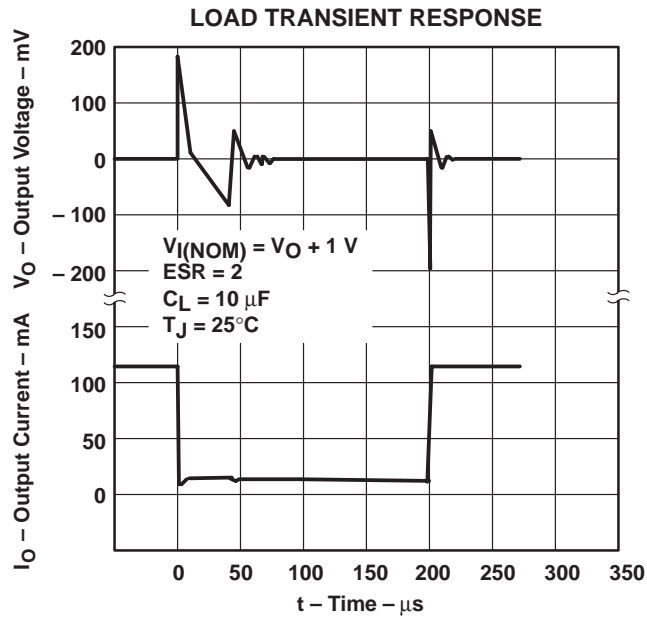

Figure 9

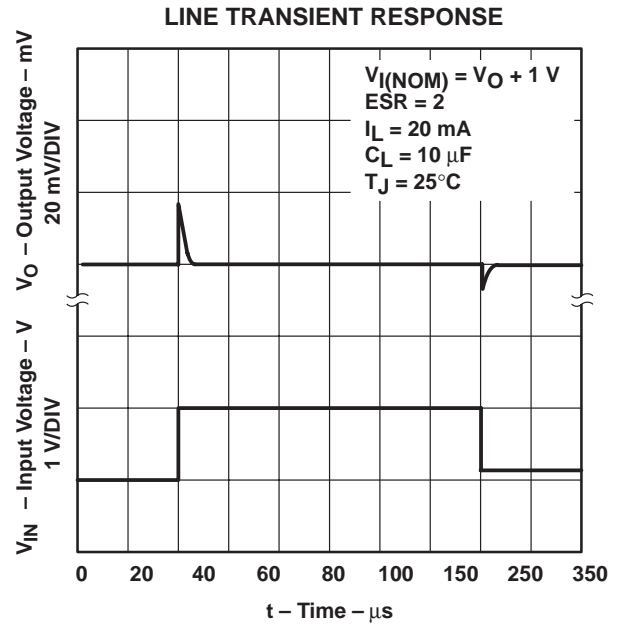

Figure 10

**PACKAGING INFORMATION**

Orderable Device	Status <sup>(1)</sup>	Package Type	Package Drawing	Pins	Package Qty	Eco Plan <sup>(2)</sup>	Lead/Ball Finish	MSL Peak Temp <sup>(3)</sup>
TL750M05CKC	ACTIVE	TO-220	KC	3	50	TBD	Call TI	Level-1-220C-UNLIM
TL750M05CKTER	ACTIVE	PFM	KTE	3	2000	TBD	Call TI	Level-1-220C-UNLIM
TL750M05CKTPR	ACTIVE	PFM	KTP	2	3000	TBD	CU SNPB	Level-1-220C-UNLIM
TL750M10CKC	PREVIEW	TO-220	KC	3	50	TBD	Call TI	Call TI
TL750M12CKC	PREVIEW	TO-220	KC	3	50	TBD	Call TI	Call TI
TL751M05CKTGR	PREVIEW	PFM	KTG	5	2000	TBD	Call TI	Level-1-220C-UNLIM

<sup>(1)</sup> The marketing status values are defined as follows:

**ACTIVE:** Product device recommended for new designs.

**LIFEBUY:** TI has announced that the device will be discontinued, and a lifetime-buy period is in effect.

**NRND:** Not recommended for new designs. Device is in production to support existing customers, but TI does not recommend using this part in a new design.

**PREVIEW:** Device has been announced but is not in production. Samples may or may not be available.

**OBsolete:** TI has discontinued the production of the device.

<sup>(2)</sup> Eco Plan - The planned eco-friendly classification: Pb-Free (RoHS) or Green (RoHS & no Sb/Br) - please check <http://www.ti.com/productcontent> for the latest availability information and additional product content details.

**TBD:** The Pb-Free/Green conversion plan has not been defined.

**Pb-Free (RoHS):** TI's terms "Lead-Free" or "Pb-Free" mean semiconductor products that are compatible with the current RoHS requirements for all 6 substances, including the requirement that lead not exceed 0.1% by weight in homogeneous materials. Where designed to be soldered at high temperatures, TI Pb-Free products are suitable for use in specified lead-free processes.

**Green (RoHS & no Sb/Br):** TI defines "Green" to mean Pb-Free (RoHS compatible), and free of Bromine (Br) and Antimony (Sb) based flame retardants (Br or Sb do not exceed 0.1% by weight in homogeneous material)

<sup>(3)</sup> MSL, Peak Temp. -- The Moisture Sensitivity Level rating according to the JEDEC industry standard classifications, and peak solder temperature.

**Important Information and Disclaimer:**The information provided on this page represents TI's knowledge and belief as of the date that it is provided. TI bases its knowledge and belief on information provided by third parties, and makes no representation or warranty as to the accuracy of such information. Efforts are underway to better integrate information from third parties. TI has taken and continues to take reasonable steps to provide representative and accurate information but may not have conducted destructive testing or chemical analysis on incoming materials and chemicals. TI and TI suppliers consider certain information to be proprietary, and thus CAS numbers and other limited information may not be available for release.

In no event shall TI's liability arising out of such information exceed the total purchase price of the TI part(s) at issue in this document sold by TI to Customer on an annual basis.

KTE (R-PSFM-G3)

PowerFLEX™ PLASTIC FLANGE-MOUNT

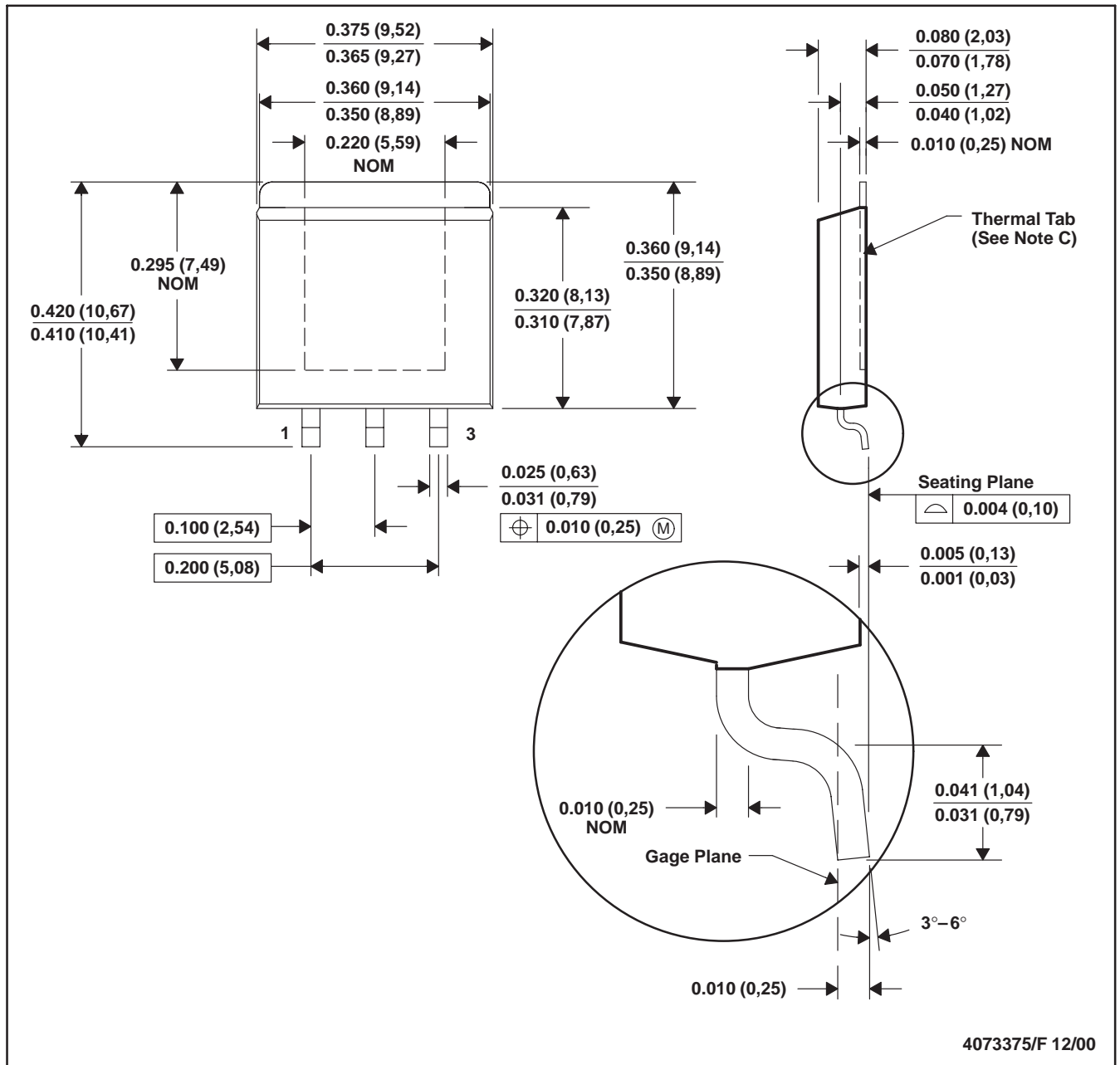

- NOTES: A. All linear dimensions are in inches (millimeters).  
 B. This drawing is subject to change without notice.  
 C. The center lead is in electrical contact with the thermal tab.  
 D. Dimensions do not include mold protrusions, not to exceed 0.006 (0,15).  
 E. Falls within JEDEC MO-169

PowerFLEX is a trademark of Texas Instruments.



KTG (R-PSFM-G5)

PowerFLEX™ PLASTIC FLANGE-MOUNT PACKAGE

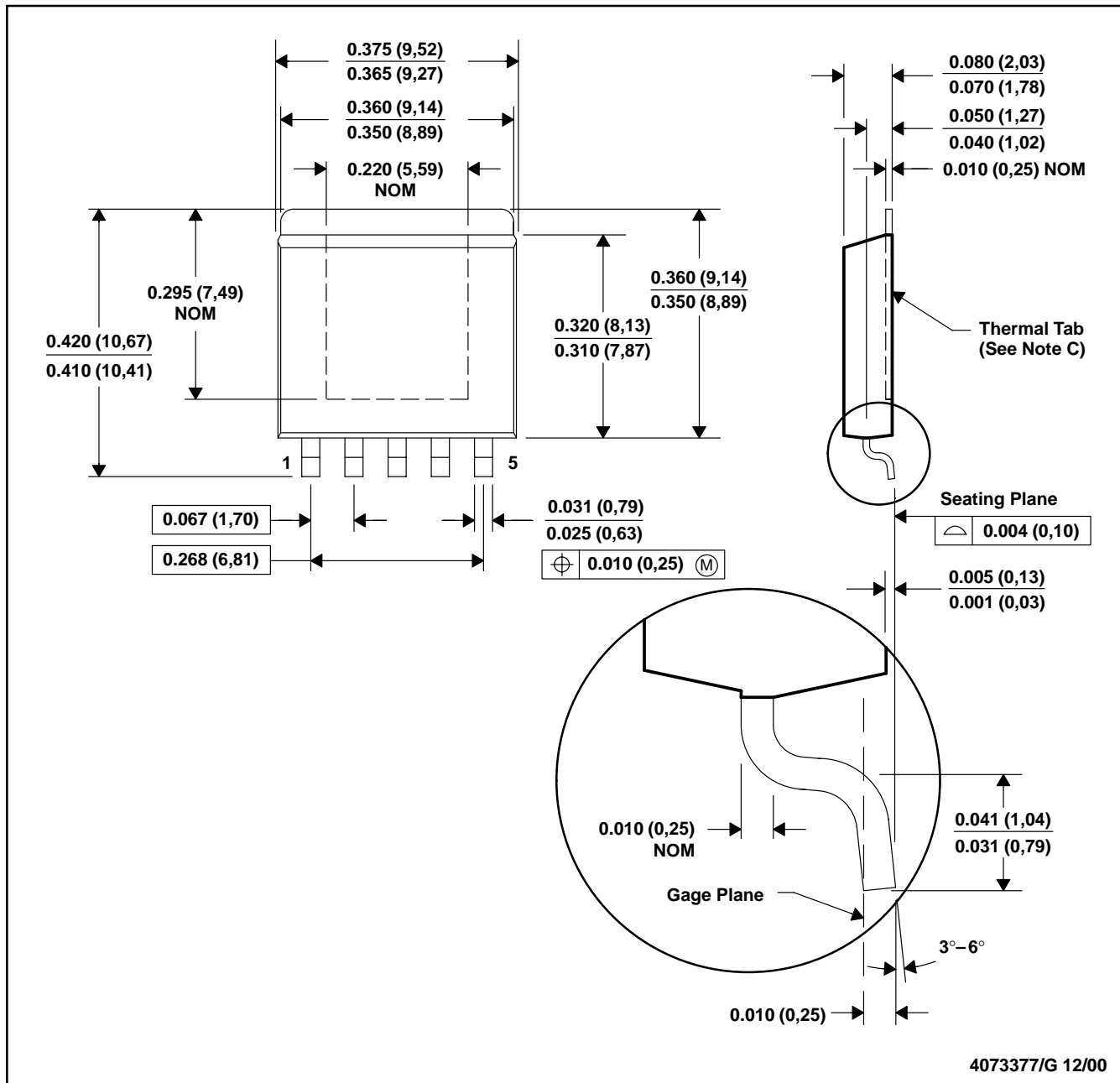

- NOTES: A. All linear dimensions are in inches (millimeters).  
 B. This drawing is subject to change without notice.  
 C. The center lead is in electrical contact with the thermal tab.  
 D. Dimensions do not include mold protrusions, not to exceed 0.006 (0,15).  
 E. FALLS WITHIN JEDEC MO-169

PowerFLEX is a trademark of Texas Instruments.



KTP (R-PSFM-G2)

PowerFLEX™ PLASTIC FLANGE-MOUNT PACKAGE



- NOTES: A. All linear dimensions are in inches (millimeters).  
 B. This drawing is subject to change without notice.  
 C. The center lead is in electrical contact with the thermal tab.  
 D. Dimensions do not include mold protrusions, not to exceed 0.006 (0,15).  
 E. Falls within JEDEC TO-252 variation AC.

PowerFLEX is a trademark of Texas Instruments.



KC (R-PSFM-T3)

PLASTIC FLANGE-MOUNT PACKAGE

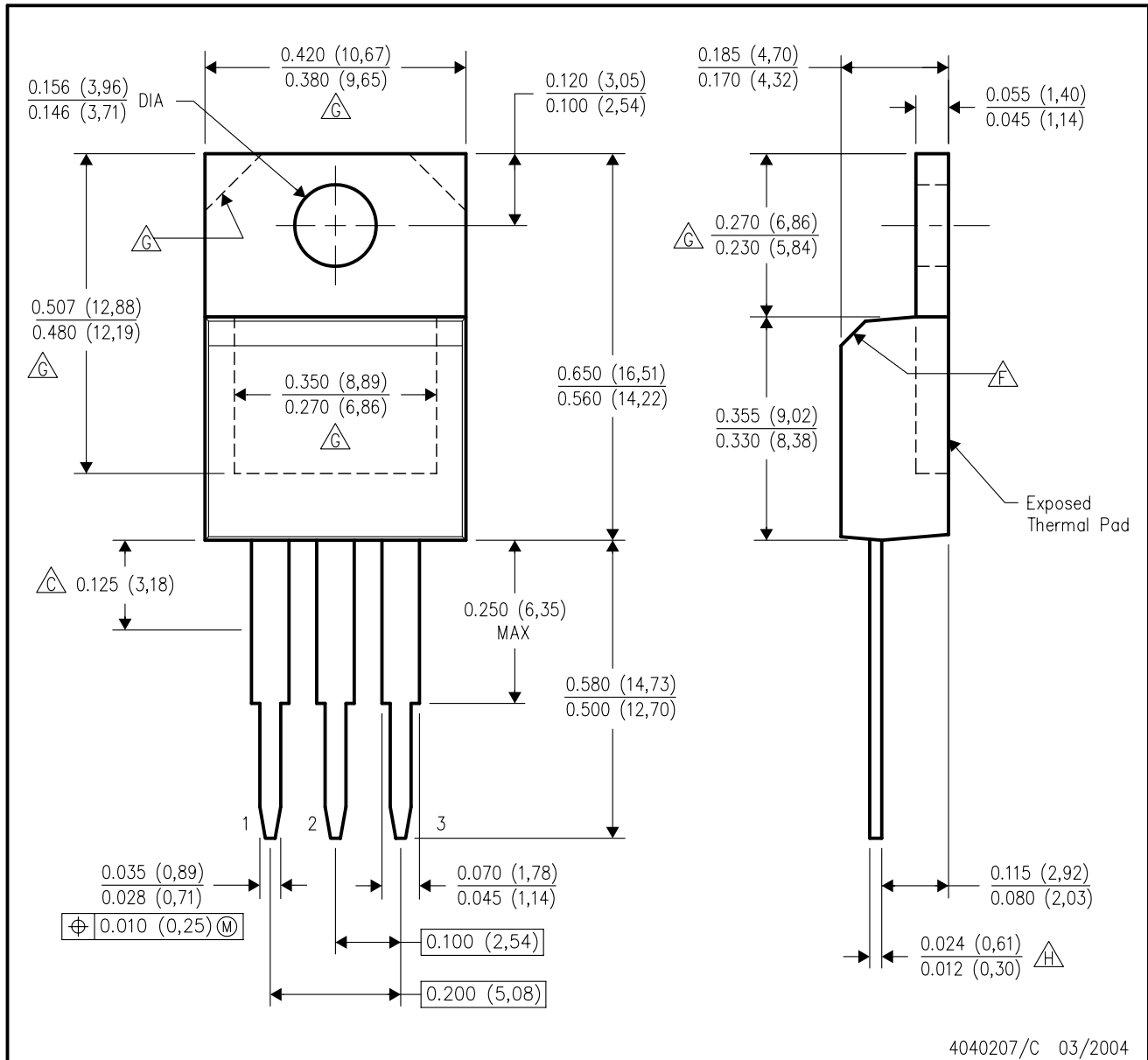

- NOTES:
- A. All linear dimensions are in inches (millimeters).
  - B. This drawing is subject to change without notice.
  - $\triangle C$  Lead dimensions are not controlled within this area.
  - D. All lead dimensions apply before solder dip.
  - E. The center lead is in electrical contact with the mounting tab.
  - $\triangle F$  The chamfer is optional.
  - $\triangle G$  Thermal pad contour optional within these dimensions.
  - $\triangle H$  Falls within JEDEC TO-220 variation AB, except minimum lead thickness.



## IMPORTANT NOTICE

Texas Instruments Incorporated and its subsidiaries (TI) reserve the right to make corrections, modifications, enhancements, improvements, and other changes to its products and services at any time and to discontinue any product or service without notice. Customers should obtain the latest relevant information before placing orders and should verify that such information is current and complete. All products are sold subject to TI's terms and conditions of sale supplied at the time of order acknowledgment.

TI warrants performance of its hardware products to the specifications applicable at the time of sale in accordance with TI's standard warranty. Testing and other quality control techniques are used to the extent TI deems necessary to support this warranty. Except where mandated by government requirements, testing of all parameters of each product is not necessarily performed.

TI assumes no liability for applications assistance or customer product design. Customers are responsible for their products and applications using TI components. To minimize the risks associated with customer products and applications, customers should provide adequate design and operating safeguards.

TI does not warrant or represent that any license, either express or implied, is granted under any TI patent right, copyright, mask work right, or other TI intellectual property right relating to any combination, machine, or process in which TI products or services are used. Information published by TI regarding third-party products or services does not constitute a license from TI to use such products or services or a warranty or endorsement thereof. Use of such information may require a license from a third party under the patents or other intellectual property of the third party, or a license from TI under the patents or other intellectual property of TI.

Reproduction of information in TI data books or data sheets is permissible only if reproduction is without alteration and is accompanied by all associated warranties, conditions, limitations, and notices. Reproduction of this information with alteration is an unfair and deceptive business practice. TI is not responsible or liable for such altered documentation.

Resale of TI products or services with statements different from or beyond the parameters stated by TI for that product or service voids all express and any implied warranties for the associated TI product or service and is an unfair and deceptive business practice. TI is not responsible or liable for any such statements.

Following are URLs where you can obtain information on other Texas Instruments products and application solutions:

<b>Products</b>		<b>Applications</b>	
Amplifiers	<a href="http://amplifier.ti.com">amplifier.ti.com</a>	Audio	<a href="http://www.ti.com/audio">www.ti.com/audio</a>
Data Converters	<a href="http://dataconverter.ti.com">dataconverter.ti.com</a>	Automotive	<a href="http://www.ti.com/automotive">www.ti.com/automotive</a>
DSP	<a href="http://dsp.ti.com">dsp.ti.com</a>	Broadband	<a href="http://www.ti.com/broadband">www.ti.com/broadband</a>
Interface	<a href="http://interface.ti.com">interface.ti.com</a>	Digital Control	<a href="http://www.ti.com/digitalcontrol">www.ti.com/digitalcontrol</a>
Logic	<a href="http://logic.ti.com">logic.ti.com</a>	Military	<a href="http://www.ti.com/military">www.ti.com/military</a>
Power Mgmt	<a href="http://power.ti.com">power.ti.com</a>	Optical Networking	<a href="http://www.ti.com/opticalnetwork">www.ti.com/opticalnetwork</a>
Microcontrollers	<a href="http://microcontroller.ti.com">microcontroller.ti.com</a>	Security	<a href="http://www.ti.com/security">www.ti.com/security</a>
		Telephony	<a href="http://www.ti.com/telephony">www.ti.com/telephony</a>
		Video & Imaging	<a href="http://www.ti.com/video">www.ti.com/video</a>
		Wireless	<a href="http://www.ti.com/wireless">www.ti.com/wireless</a>

Mailing Address: Texas Instruments  
Post Office Box 655303 Dallas, Texas 75265