

XL-ITR9909**技术数据表** Technical Data Sheet**反射式光电开关****特点 (Characteristic) :**

* 可靠性高、辐射强度高、低电压驱动

High reliability 、High radiant intensity 、Low forward voltage

* 感应速度快、感光度强

Fast response time 、High photo sensitivity

* 截止感应波长940nm

Cut-off visible wavelength $\lambda_p=940\text{nm}$

* 无铅材料、Rohs认证

Pb.Free 、RoHS compliant version

* 湿气敏感性等级 (MSL) :4-5级

Moisture sensitivity level (MSL) : 4-5 levels

**应用领域 (Product application) :**

* 鼠标

Mouse

* 打印机复印机

Printer copier

* 开关扫描仪软盘驱动器

Switch scanner floppy drive

* 非接触式开关直接板

Non contact switch direct board

* 感应洁具

Induction sanitary ware

* 感应水龙头

Sensor faucet



目录

Catalogue

电性参数 Electrical Characteristics.....	3
典型特性曲线 Typical Characteristic Curves.....	6
外形尺寸 Outline Dimensions.....	9
包装 Packaging.....	10
焊接指导 Guideline for Soldering.....	11
使用注意事项 Precautions.....	13

电性参数

Electrical Characteristics

◇极限参数 (温度=25°C): Absolute Maximum Ratings (Temperature=25°C):

测试项目 Parameter		符号 Symbol	数值 Ratings	单位 Unit
输入端发射极 Input Emitter	功率 Power Dissipation*1	PD	75	mW
	正向输入电流 Continuous Forward Current	IF	50	mA
	脉冲正向电流 Peak Forward Current*2	IFP	1	A
	反向电压 Reverse Voltage	VR	5	V
输出端接收极 Output Detector	功率 Power Dissipation*1	PD	75	mW
	集电压-发射极电压 Collector-Emitter Voltage	VCEO	30	V
	发射极-集电极电压 Emitter-Collector Voltage	VECO	5	V
	集电极电流 Collector Current	IC(on)	50	mA
工作温度 Operating Temperature		Topr	-20~+85	°C
储存温度 Storage Temperature		Tstg	-40~+85	°C
焊接温度 Lead Soldering Temperature*3		Tsol	260	°C

光电参数 (温度=25℃) :Electro-Optical Charasteristics (Temperature=25°C):

参数 Parameter		符号 Symbol	测试条件 Testconditions	最小 Min	平均 Typ	最大 Max	单位 Unit
输入端 Input	正向电压 Forward Voltage	VF	IF=20mA	--	1.2	1.5	V
			IF=100mA*2	--	1.4	1.85	
			IF=1A *2	--	2.6	4.0	
	峰值波长 Perk Wavelength	λP	IF=20mA	--	940	--	nm
	反向电流 Reverse Current	IR	VR=5V	--	--	10	μA
输出端 Output	暗电流 Dark Current	ICEO	Ee=0mW/cm ² VCE=20V	--	--	100	nA
	集电极-发射极的工作电压 C-E Saturation Voltage	VCE(SA T)	IC=2mA Ee= 1mW/cm ²	--	--	0.4	V
转换特性 Transfer Characteristics	上升时间 Rise Time	tr	VCE=5V IC= 1mA RL= 1000Ω	--	15	--	μS
	下降时间 Fall Time	tf		--	15	--	
	光电流 Collector Current	IC(ON)	IF=20mA VCE=5V	0.2	--	6	mA

备注(Note):

- * 在 25 摄氏度的环境中测试 below 25 Free Air Temperature
- * 脉宽少于等于 100us , 占空比 1% Pulse width ≤ 100μs,Duty cycle= 1%
- * 离胶体 2mm 以上焊接 5s 内 2mm form body for 5 seconds

电压分档:

Voltage grading:

代码 Code	最小值 Min	最大值 Max	单位 Unit	测试条件 Test conditions
M17-3	1.2	1.3	V	IF=20mA
N17-4	1.3	1.4		
N17-5	1.4	1.5		

光电流分档:

Collector Current grading:

代码 Code	最小值 Min	最大值 Max	单位 Unit	测试条件 Test conditions
IC4-25	0.2	6.0	mA	IF=20mA VCE=5V

典型特性曲线

Typical Characteristics Curves

发射管特性曲线图 Typical Electro-Optical Characteristics Curves-IR

正向电流与环境温度的关系

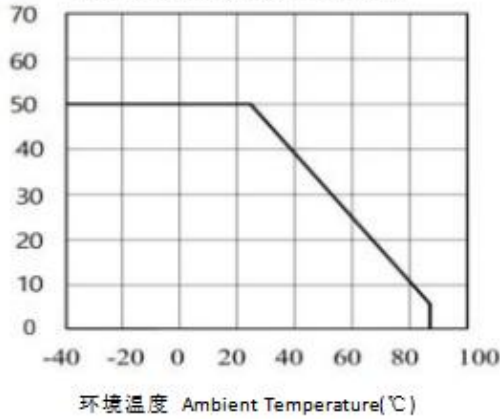

正向电流与正向电压的关系

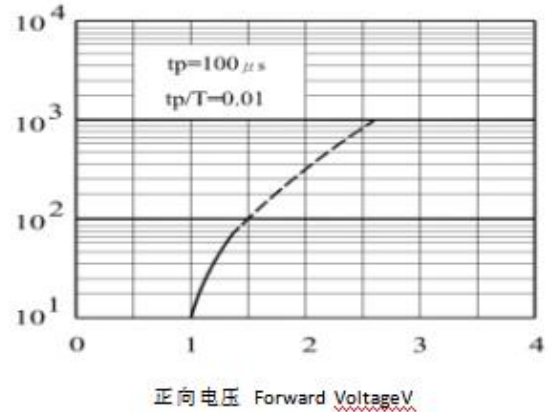

辐射强度与正向电流的关系

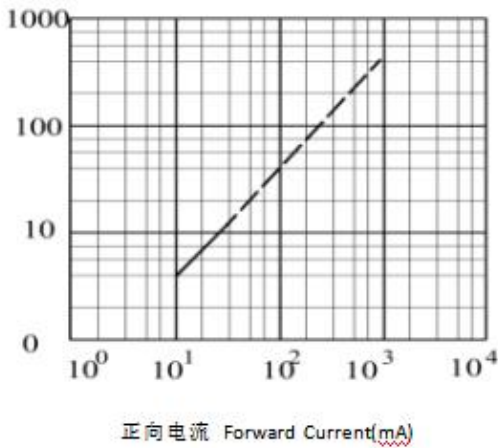

波长曲线图

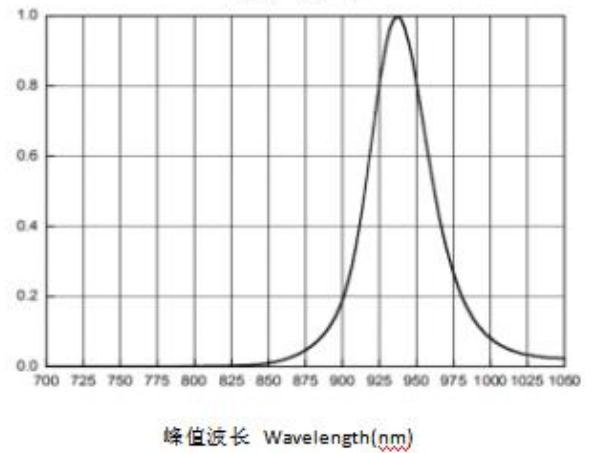

峰值波长与环境温度的关系

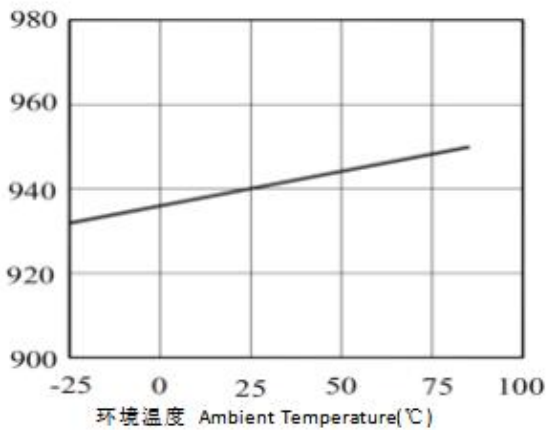

相对辐射强度与角位移的关系

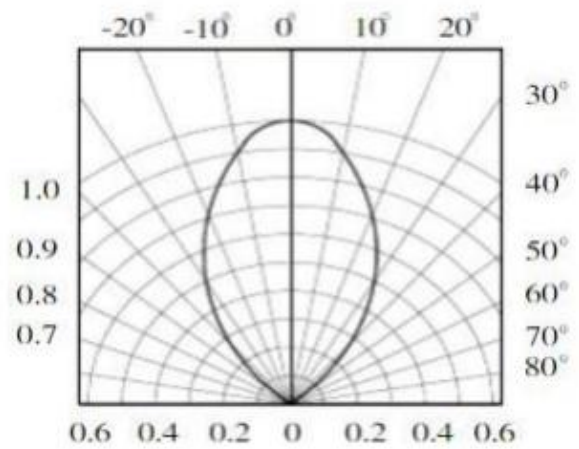

接收管特性曲线图 Typical Electro-Optical Characteristics Curves-PT

集电极功率与环境温度的关系

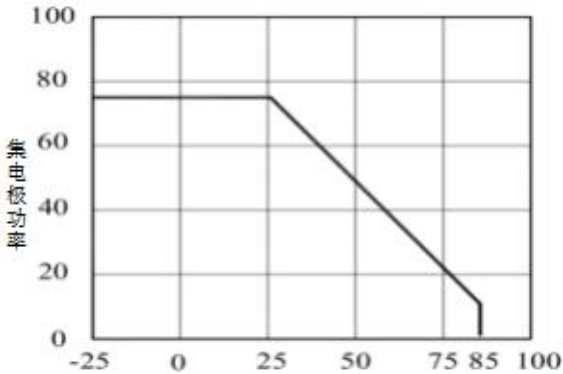

环境温度 Ambient Temperature(°C)

相对集电极电流与环境温度的关系

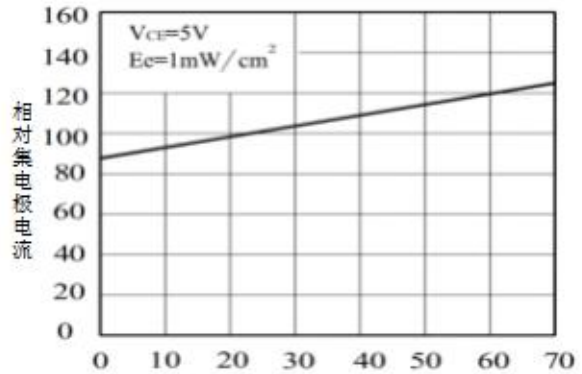

环境温度 Ambient Temperature(°C)

集电极暗电流与环境温度的关系

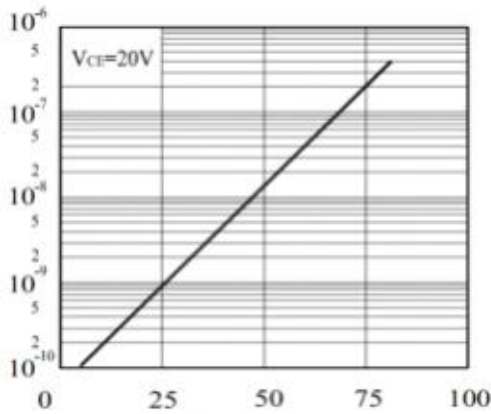

环境温度 Ambient Temperature(°C)

感应波长图

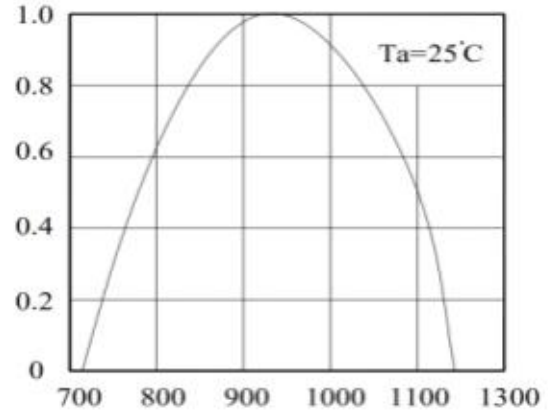

峰值波长 Wavelength(nm)

集电极电流与辐射强度的关系

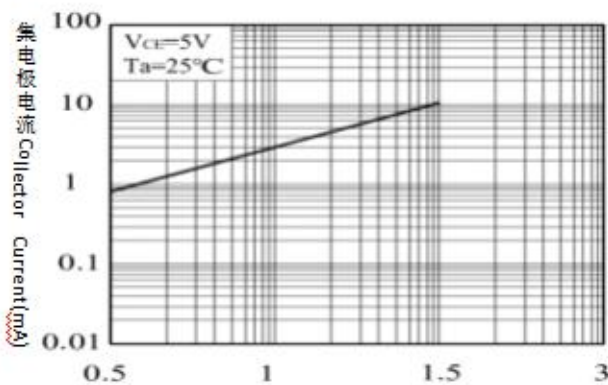

集电极电流与集电极-发射极电压的关系

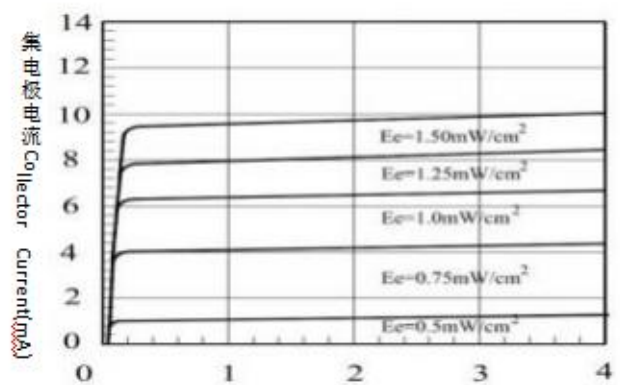

光电开关特性曲线图 Typical Electro-Optical Characteristics Curves-ITR

光电流与感应距离之间的关系
Relative Collector Current vs Distance Between Sensor

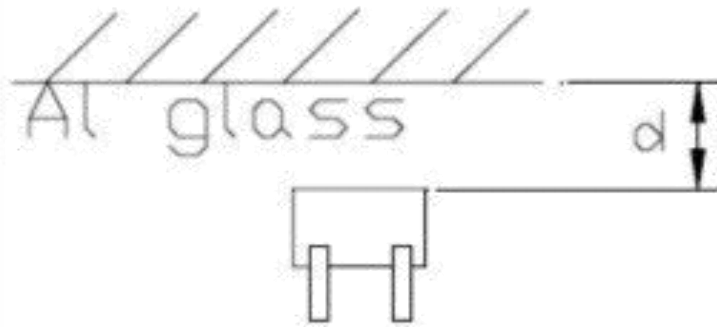
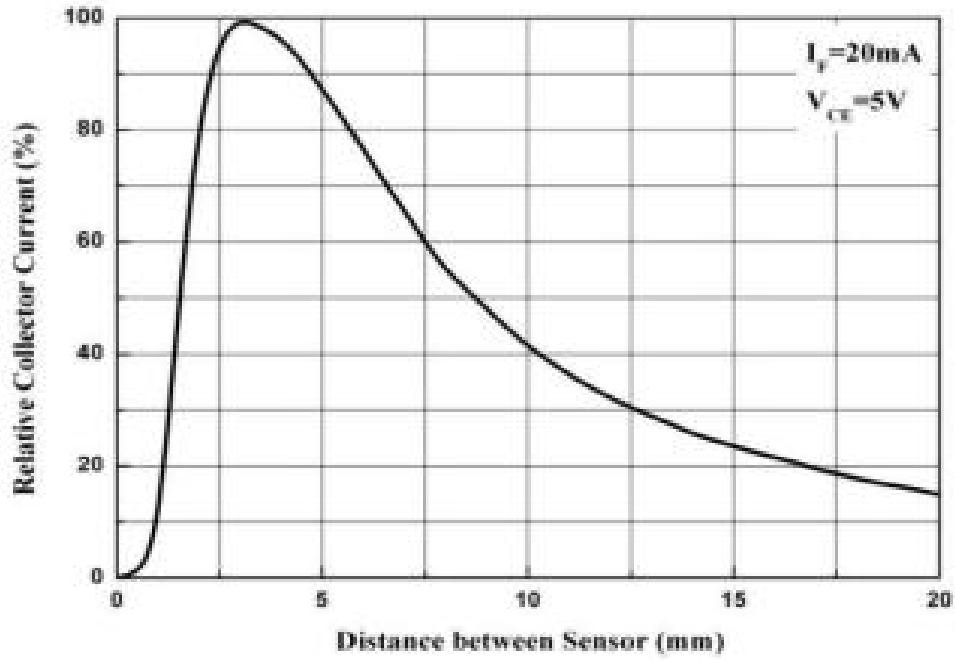

外形尺寸

Outline Dimension

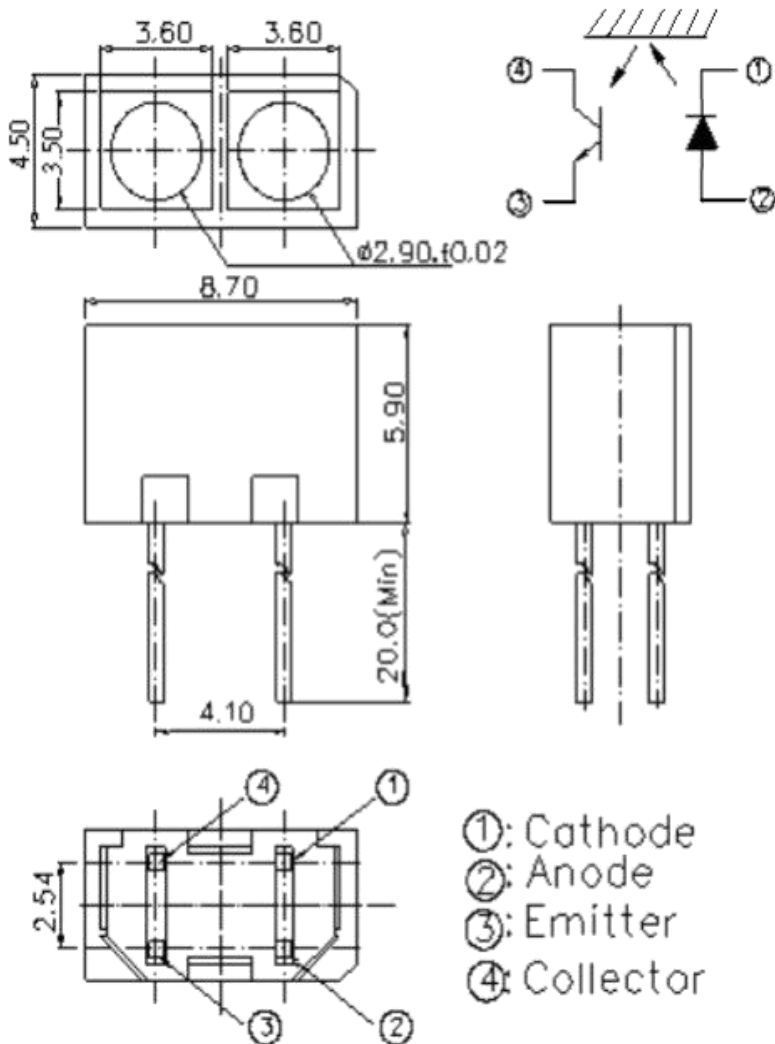

备注：1.单位：毫米（mm）

Remarks: 1 Unit: mm

2.公差：无特别标注则为 $\pm 0.3\text{mm}$

2. Tolerance: $\pm 0.3\text{mm}$ unless otherwise specified

包装规格

Packing Specification

防静电袋 Anti-electrostatic bag



150 只/袋
150pcs/bag



内包装盒 Inner Carton

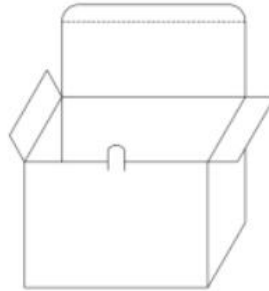

5 袋/盒
5bags/Inner Carton



外箱 Outside Carton

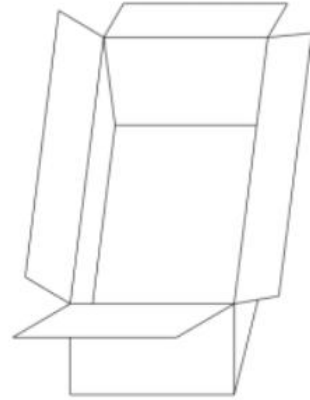

10 盒/箱
10 Inner Cartons/Outside Carton

焊接指导

Guideline for Soldering

推荐波峰焊曲线 The wave peak welding curve is recommended :

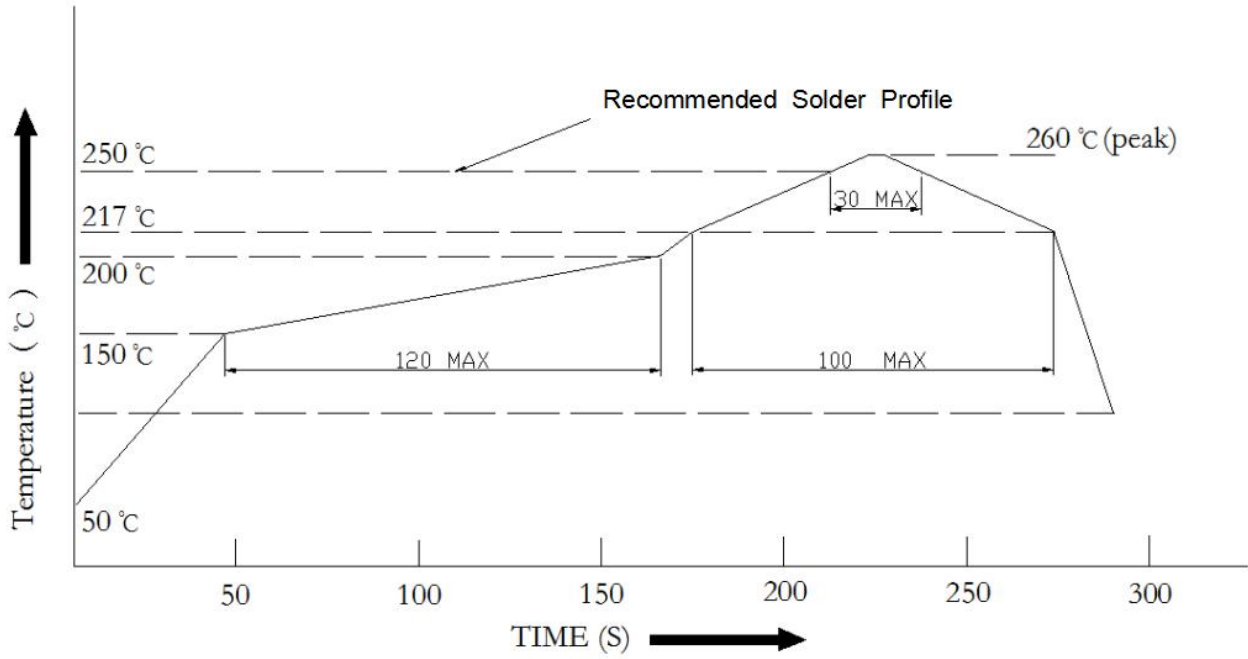

烙铁条件 Soldering Iron

每个端子都要去烙铁尖端温度低于 300°C为 3 秒内一次少于烙铁容量 25W 。 离开两秒钟然后更多的间隔，并做焊接每个终端。手工焊料通常在开始的时候容易损坏产品。

Each terminal is to go to the tip of soldering iron temperature less than 300°C for 3 seconds within once in less than the soldering iron capacity 25W. Leave two seconds and more intervals, and do soldering of each terminal. Be careful because the damage of the product is often started at the time of the hand solder.

*手工补数 Repairing

修理不应在 LED 焊接后进行。当修理是不可避免的是，应该使用双头烙铁 (如下图所示)。应该是事先确认 LED 的特性是否会或不会损坏通过修理。

Repair should not be done after the LED have been soldered. When repairing is unavoidable, a double-head soldering iron should be used (as below figure). It should be confirmed beforehand whether the characteristics of the LED will or will not be damaged by repairing.

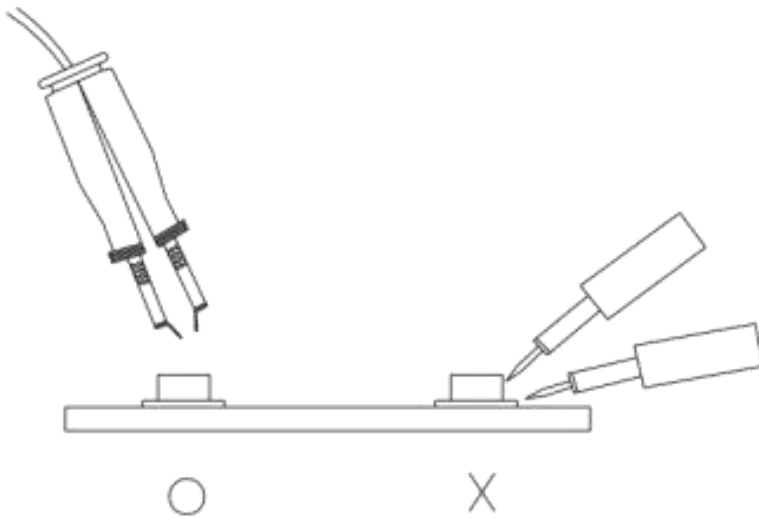

使用注意事项

Precautions

XL-ITR9909 由红外发射二极管和 NPN 硅光晶体管组成，它们并排封装在黑色热塑性外壳中的汇聚光轴上。光电晶体管只接收来自IR的辐射。这是正常情况。但当物体在中间时，光电晶体管不能接收辐射。有关更多组件信息，请参阅IR和PT。

XL-ITR9909 It is composed of infrared emission diode and NPN silicon photo transistor, which are packaged side by side in black On the converging optical axis in the thermoplastic shell. Photo transistor only receives radiation from IR. This is normal Condition. But when the object is in the middle, the photo transistor cannot receive radiation. For more component information, please Refer to IR and PT.

* 注意: Note

1 、铅焊料温度剖面

Lead solder temperature profile

2 、波峰焊不应做一次以上

Peak welding shall not be done more than once

3 、焊接时，不要在加热过程中对 LED 施加压力

When soldering, do not put stress on the LED during heating

4 、焊接后，不要使电路板翘曲

After soldering, do not warp the circuit board