

6070 球头白 (1w) 发光二极管**特点 (Characteristics) :**

- * 发光颜色及胶体: 高亮度白/黄色胶体
Luminous color and colloid: High brightness white / Yellow colloid
- * 封装支架: 6070 支架
Packaging glue : 6070 bracket
- * 发光角度: 140 度
Luminous Angle: 140 degrees
- * 环保工艺符合 ROHS 标准
Environmental protection products Complied With RoHS Directive
- * 湿气敏感性等级 (MSL) :2a-3 级
Moisture sensitivity level (MSL) : 2a-3 levels
- * EIA 规范标准包装
EIA standard packaging
- * 适用于 SMT 贴片自动化生产
Suitable for SMT automatic production
- * 适用于回流焊制程 ($\leq 200^{\circ}\text{C}$)
Suitable for reflow soldering process ($\leq 200^{\circ}\text{C}$)

应用领域 (Product application) :

- * 筑照明灯, 洗墙灯, 投光灯
Building lighting, wall washing, and projection lights
- * 城市亮化照明, 雕塑照明
Urban lighting, sculpture lighting
- * 舞台灯 stage lights;, 广告牌照明
Billboard lighting
- * 展览展示、体育场馆、商场
Exhibition, sports venues, shopping malls
- * 公共交通
mass transit
- * 路灯



目录

Catalogue

电性参数

Electrical Characteristics.....3

典型特性曲线

Typical Characteristic Curves.....6

可靠性实验

Reliability Test Items And Conditions.....7

外形尺寸

Outline Dimensions.....8

包装

Packaging.....9

焊接指导

Guideline for Soldering.....11

使用注意事项

Precautions.....13

电性参数

Electrical Characteristics

极限参数 (Ta=25℃) Absolute Maximum Rating (ta=25 °C)

电气特性 Electrical characteristics	符号 Symbol	数值 Ratings	单位 Unit
功率 Power Dissipation	PD	1	W
正向输入电流 Continuous Forward Current	IF	350	mA
顺向脉冲电流 Peak Forward Current	IFP	1400	mA
结点温度 LED Junction Temperature	TJ	120	°C
反向电压 Reverse Voltage	VR	5	V
工作温度 Operating Temperature	Topr	-20 ~ +85°C	
存储温度 Storage Temperature	Tstg	-40 ~ +85°C	
焊接条件 Welding conditions	Tsol	回流焊 (reflow soldering) : 200°C, ≦5s 手动焊 (manual welding) : 300°C, 3s	
抗静电能力 ESD Sensitivity	ESD	3000V HBM	

* 注: 脉冲宽度≤0.1ms, 占空比≤1/10

* Note: Pulse width≤0.1ms, Duty≤1/10

光电参数 (Ta=25°C) Optical-electrical parameter (ta=25 °C)

参数 Parameter	符号 Symbol	测试条件 Test conditions	最小 Min	平均 Typ	最大 Max	单位 Unit
光通量 Luminous Intensity	Φ	IF=350mA	110	/	130	LM
显色指数 Color rendering index	Ra		/	72	/	/
色温 Color Temperature	TC		6000	/	6500	K
正向压降 Forward Voltage	VF		3.0	3.2	3.4	V
发光角度 Viewing Angle	2Θ1/2		-	120	-	Deg
反向漏电流 Reverse Current	IR	VR=5V	--	--	5	μA

亮度分档:

Brightness grading:

代码 Code	最小值 Min	最大值 Max	单位 Unit	测试条件 Test conditions
K3	100	110	LM	IF=350mA
K4	110	120		
K5	120	130		

电压分档:

Voltage grading:

代码 Code	最小值 Min	最大值 Max	单位 Unit	测试条件 Test conditions
N13-3	2.8	3.0	V	IF=350mA
N13-4	3.0	3.2		
N13-5	3.2	3.4		

色温分档:

Color Temperature division:

代码 Code	最小值 Min	最大值 Max	单位 Unit	测试条件 Test conditions
UW8-10	6000	6500	K	IF=350mA

典型特性曲线

Typical Characteristics Curves

Spectrum Distribution
(光谱分析图)

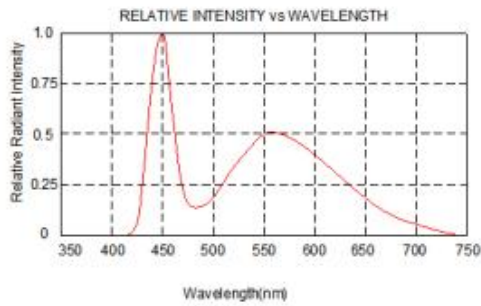

Forward current - luminous intensity curve
(正向电流-发光强度图)

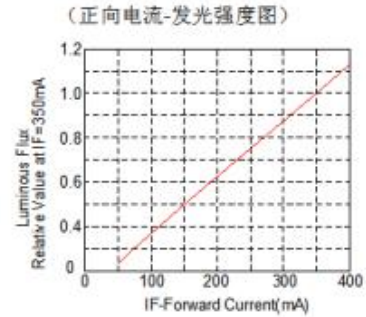

Forward current - voltage curve
(正向电流-电压曲线图)

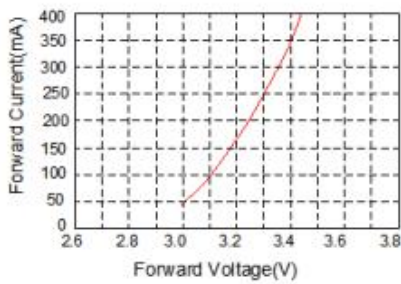

Relative Luminous Intensity VS Ambient Temperature
(温度-发光强度曲线图)

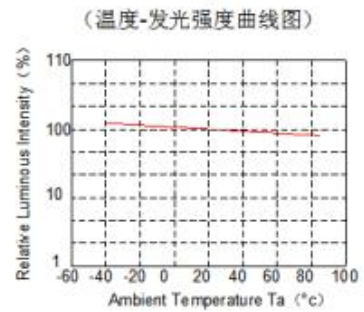

LED光强分布曲线(1000mA测试) Intensity distribution curve (1000mA test):

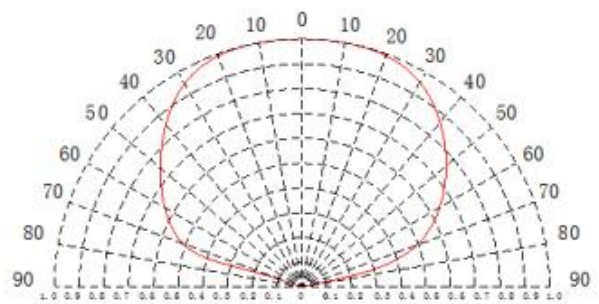
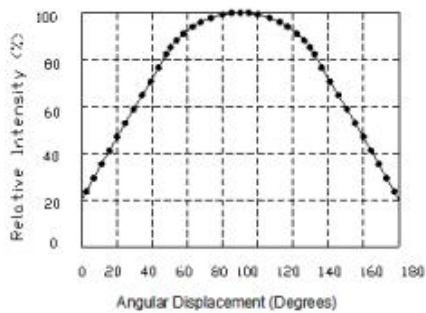

可靠性试验

Reliability Test Items And Conditions

测试项目 Test Parameter	测试条件 Test Condition
连续运行试验 Continuous Operation Test	IF=350mA Ta=25°C × 1000hrs
	IF=350mA Tj=140°C × 1000hrs
低温贮存试验 Low Temperature Storage Test	-40 °C × 1000 hours
高温贮存试验 High Temperature Storage Test	100°C × 1000 hours
高温高湿试验 Moisture-proof Test	85 °C, 85 %RH for 500 hours
冷热冲击试验 Thermal Shock Test	-40 °C × 30 minutes—100 °C × 30 minutes, 100 cycle

***1 失效判断标准 Criteria For Judging Damage**

项目 Parameter	符号 Symbol	实验条件 Measuring Condition	判定标准 Judgement standard
正向电压 Forward Voltage	VF	IF=350mA	>U × 1.1
总光通量 Total Luminous Flux	Φ	IF=350mA	<S × 0.85

* U 为实验前电压的初始值，S 为实验后光通量的值。

* U defines the upper limit of the specified characteristics. S defines the initial value.

* 每个试验完成后试验样品均被放置回正常的环境条件下，并且在 2 到 24 小时内测试完。

* Measurement shall be taken between 2 hours and 24 hours, and the test pieces should be return to the normal ambient conditions after the completion of each test.

外形尺寸

Outline Dimension

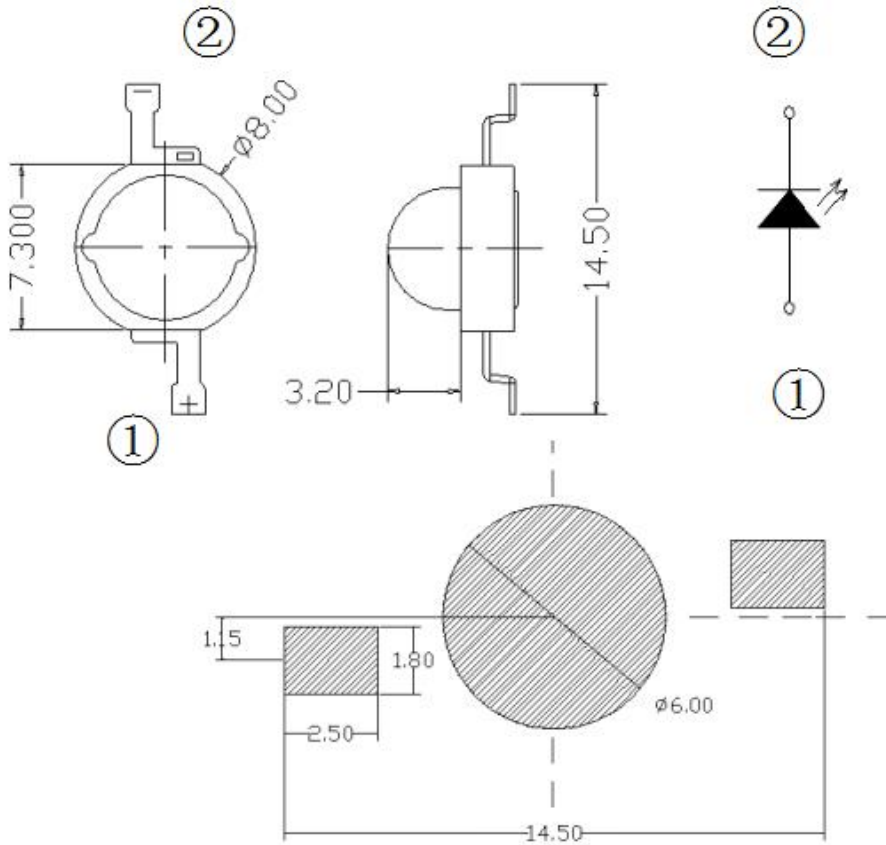

推荐焊盘
Recommand soldering pad

备注: 1. 以上尺寸单位均为 mm
Remarks: All dimensions are in millimeters.

2. 未特别标注公差尺寸公差均为 $\pm 0.25\text{mm}$
Tolerance is $\pm 0.25\text{mm}$ unless otherwise noted

包装 (1)

Packaging (1)

载带与圆盘尺寸 Belt and disk dimensions

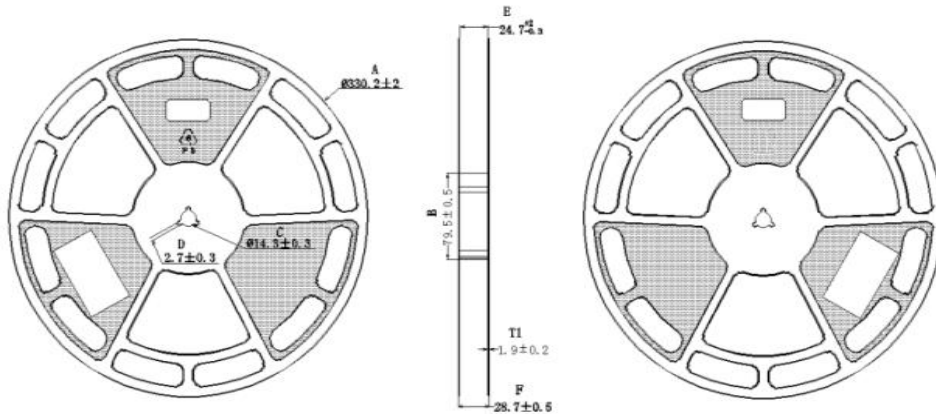
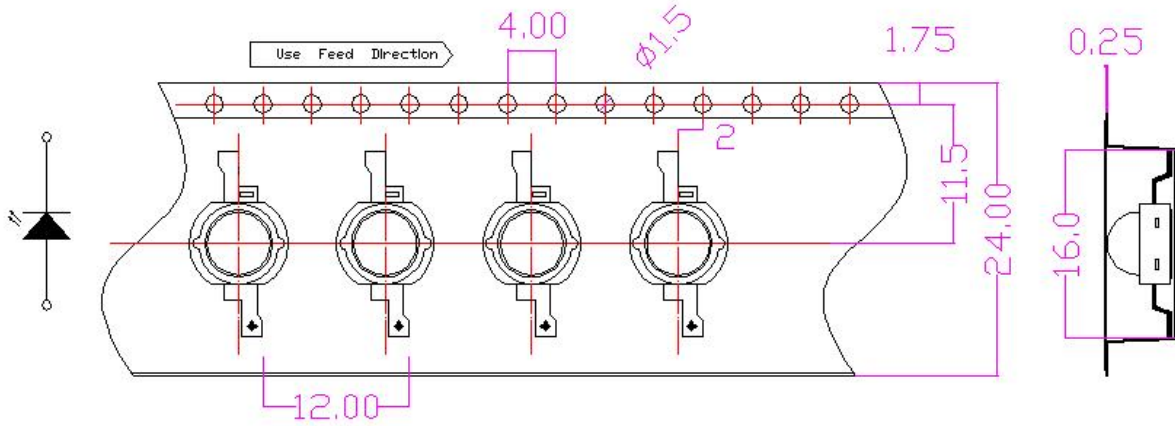

A±2	B±0.5	C±0.3	D±0.3	E ^{±0.3}	F±0.5	T1±0.2
Ø330.2	Ø79.5	Ø14.3	2.7	24.7	28.7	1.9

注:

1. 尺寸单位为毫米(mm)。
1. Size unit is mm (mm).
2. 尺寸公差是±0.1mm。
2. The dimensional tolerance is ± 0.1mm.

圆盘及载带卷出方向及空穴规格 Disk and carrier belt direction of roll and hole dimensions

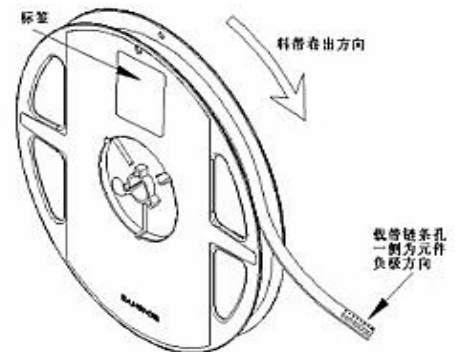
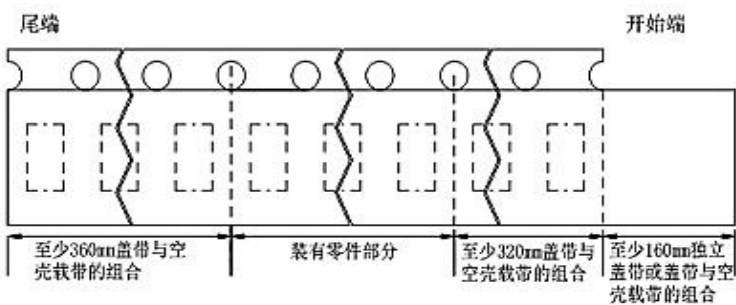

包装 (2)

Packaging (2)

◇ 防潮防静电包装 Moisture Proof and Anti-Electrostatic Foil Bag

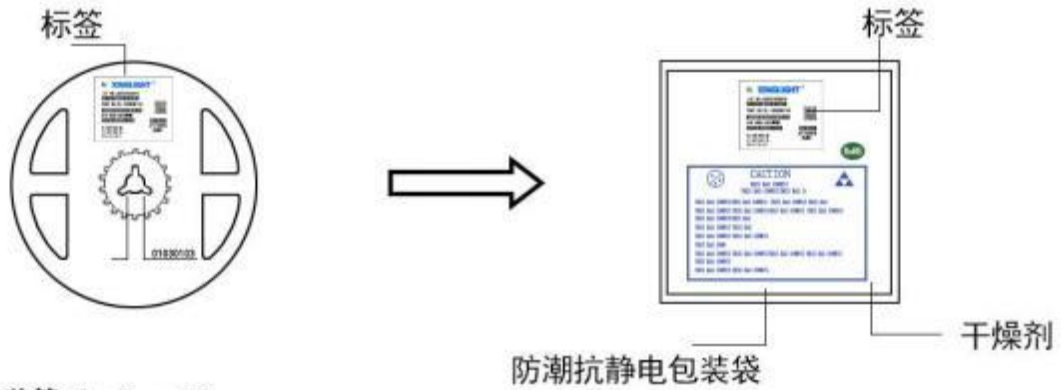

◇ 外包装箱 Cardboard Box

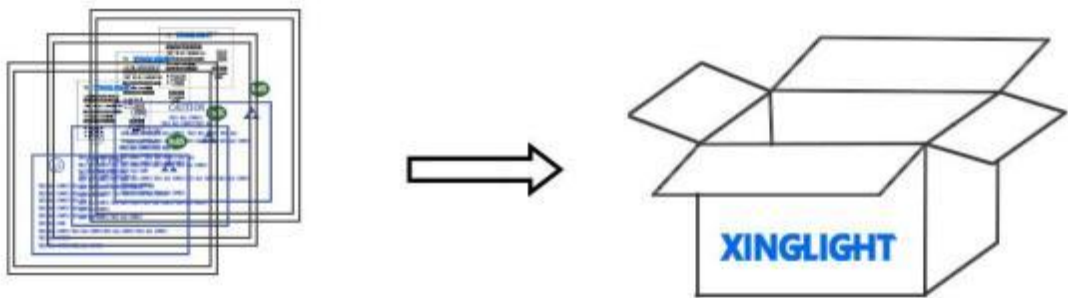

Capacity 5 or 10 reels per box (内箱容量: 50或100卷)

◇ 标签说明: Label Explanation

LOT NO: 批次信息
 PART NO: 产品型号
 BIN CODE: 产品名称
 WL: 波长范围
 IV: 光强范围
 VF: 电压范围



焊接指导 (1)

Guideline for Soldering (1)

1. 使用烙铁人手焊接

Hand Soldering

推荐使用功率低于 60 W 的烙铁, 焊接时烙铁的温度必须保持在 300℃ 以下, 且每个电极只能进行一次焊接, 每次焊接的持续时间不得超过 3 秒。

人手焊接过程中的不慎操作易引起 LED 产品的损坏, 应当小心谨慎。

A soldering iron of less than 60W is recommended to be used in Hand Soldering. Please keep the temperature of the soldering iron under 300℃ while soldering. Each terminal of the LED is to go for less than 3 second and for one time only.

Be careful because the damage of the product is often started at the time of the hand soldering.

2. 回流焊接:

Reflow Soldering:

焊接条件 Welding conditions				
回流焊 Reflow soldering			手工焊接 Manual welding	
预热每次加热时间峰值温度焊接时间条件 Preheating Time of each heating Peak temperature welding time conditions	铅焊料	无铅焊料	温度焊接时间 Temperature Welding time	300 °C最高 3 秒最高 (一次性使用) 300 °C max 3 seconds maximum (disposable)
		120~150℃ 120Sec Max 180℃ Max 10 Sec Max		

注意事项:

matters needing attention:

发光二极管是蓝光结合特殊荧光粉实现出光的装置, LED 的工作电流的改变可干扰出光颜色, 所以在使用时应当适当考虑。

LED is a device that emits light by combining blue light with special phosphor. The change of LED working current can interfere with the color of light, so it should be considered properly when using.

· 回流焊接最多只能进行一次。

Reflow soldering should not be done more than once.

· 在回流焊接升温过程中, 请不要对 LED 施加任何压力。

Stress on the LEDs should be avoided during heating in soldering process.

· 在焊接完成后, 待产品温度下降到室温之后, 再进行其他处理。

After soldering, do not deal with the product before its temperature drop down to room temperature.

焊接指导 (2)

Guideline for Soldering (2)

3. 清洗:

Cleaning

在焊接后推荐使用酒精进行清洗，在温度不高于 30°C 的条件下持续 3 分钟，不高于 50°C 的条件下持续 30 秒。

使用其他类似溶剂清洗前，请先确认使用的溶剂不会对 LED 的封装和环氧树脂部分造成损伤。超声波清洗也是有效的方法，一般最大功率不应超过 300W，否则可能对 LED 造成损伤。请根据具体的情况预先测试清洗条件是否会对 LED 造成损伤。

It is recommended that alcohol be used as a solvent for cleaning after soldering. Cleaning is to go under 30°C for 3 minutes or 50°C for 30 seconds. When using other solvents, it should be confirmed beforehand whether the solvents will dissolve the package and the resin or not.

Ultrasonic cleaning is also an effective way for cleaning. But the influence of Ultrasonic cleaning on LED depends on factors such as ultrasonic power. Generally, the ultrasonic power should not be higher than 300W. Before cleaning, a pretest should be done to confirm whether any damage to LEDs will occur.

*** 注意：** 此一般指导原则并不适用于所有 PCB 设计和焊接设备的配置。具体工艺受到诸多因素的影响，请根据特定的 PCB 设计和焊接设备来确定焊接方案。

*** Note:** This general guideline may not apply to all PCB designs and configurations of all soldering equipment. The technics in practise is influenced by many factors, it should be specialized base on the PCB designs and configurations of the soldering equipment..

使用注意事项 (1)

Precautions (1)

1. 贮存:

Storage

- 本产品使用密封防潮抗静电袋包装, 并附有干燥剂, 未开封的产品有一年的保存时间。

Moisture proof and anti-electrostatic package with moisture absorbent material is used, to keep moisture to a minimum.

- 开封前, 产品须存放在温度不高于 30℃, 湿度不高于 60%RH 的环境中。

Before opening the package, the product should be kept at 30℃ or less and humidity less than 60% RH, and be used within a year.

- 开封后, 产品须存放在温度不高于 30℃, 湿度不高于 10%RH 的环境中, 且应该在 168 小时 (7 天) 内使用完。建议工作环境为温度不高于 30℃, 湿度不高于 60%RH。

After opening the package, the product should be stored at 30℃ or less and humidity less than 10%RH, and be soldered within 168 hours (7 days). It is recommended that the product be operated at the workshop condition of 30℃ or less and humidity less than 60%RH.

- 对于尚未焊接的 LED, 如果吸湿剂或包装失效, 或者产品没有符合以上有效存储条件, 烘焙可以起到一定的性能恢复效果。烘焙条件: 60±5) °C, 持续24 小时。

If the moisture absorbent material has fade away or the LEDs have exceeded the storage time, baking treatment should be performed based on the following condition: (60±5)°C for 24 hours.

产生的热量

Heat generated

最终散热设计是应用产品至关重要的。请系统设计时考虑到 LED 工作时产生的热量, 输入的电功率, 温度系数的增加, 热传导电路装置设置及其他组件. 这些都是非常必要的. 工作电流决定后, LED 所能承受的最高环境温度也应当得到保证.

The final heat dissipation design is crucial for the application of products. Please consider the heat generated by the LED during operation, the input electric power, the increase of temperature coefficient, the setting of heat conduction circuit devices and other components during the system design. These are very necessary. After the operating current is determined, the maximum ambient temperature that the LED can withstand should also be

2. 静电:

Static Electricity

静电和电涌会导致产品特性发生改变, 例如正向电压降低等, 如果情况严重甚至会损毁产品。所以在使用时必须采取有效的防静电措施。

所有相关的设备和机器都应该正确接地, 同时必须采取其他防止静电和电涌的措施。接地交流电阻小于 1.0 欧姆, 工作台上需垫表面电阻 10⁶-10⁹ 欧姆的桌垫。在容易产生静电的环境和设备上, 还必须安装离子风扇。

使用防静电手环, 防静电垫子, 防静电工作服、工作鞋、手套, 防静电容器, 都是有效的防止静电和电涌的措施。

Static electricity or surge voltage damages the LEDs. Damaged LEDs will show some unusual characteristic such as the forward voltage becomes lower, or the LEDs do not light at the low current. even not light.

All devices, equipment and machinery must be properly grounded. The grounding ac resistance is less than 1.0 ohm, the table mat with surface resistance of 10⁶-10⁹ ohm is needed on the work table. Ion fans must also be installed in electrostatic environments and equipment. At the same time, it is recommended that wrist bands or anti-electrostatic gloves, anti-electrostatic containers be used when dealing with the LEDs.

建议:在低的电流环境下 (<20mA)受损了的 LED 将显示一些不寻常的特点, 如漏电流值的增加得注意, 正向电压变低, 或 LED 死灯。

Suggestion: Under low current environment (<20mA), the damaged LED will display some unusual features, such as the increase of leakage current value, the forward voltage becomes low, or the LED is dead.

使用注意事项 (2)

Precautions (2)

3. 设计建议:

Design Consideration

设计电路时，通过 LED 的电流不能超过规定的最大值，同时，还需使用保护电阻，否则，微小的电压变化将会引起较大的电流变化，可能导致产品损毁。

建议使用以下 (A) 电路，该电路能够很好的调节通过每个 LED 的电流；不推荐使用 (B) 电路，该电路在持续的电压驱动下，LED 的正向电压 (V_F) 发生变化，电流会随之而发生变化，可能使某些 LED 承受高于规定的电流值。

In designing a circuit, the current through each LED must not exceed the absolute maximum rating specified for each LED. In the meanwhile, resistors for protection should be applied, otherwise slight voltage shift will cause big current change, burn out may happen.

It is recommended to use Circuit A which regulates the current flowing through each LED rather than Circuit B. When driving LEDs with a constant voltage in Circuit B, the current through the LEDs may vary due to the variation in Forward Voltage (V_F) of the LEDs. In the worst case, some LED may be subjected to stresses in excess of the Absolute Maximum Rating.

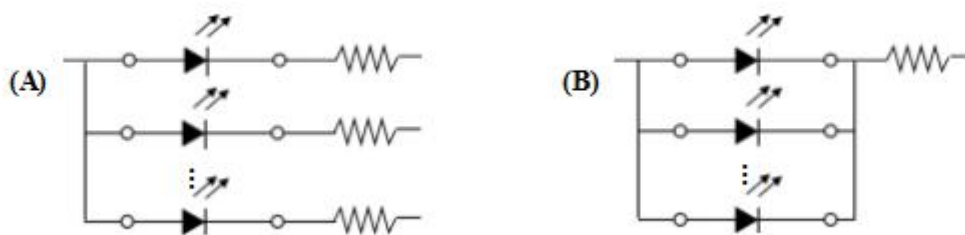

LED 的特性容易因为自身的发热和环境的温度的改变而发生改变。温度的升高会降低 LED 的发光效率、影响发光颜色等，所以在设计时应充分考虑散热的问题。

Thermal Design is paramount importance because heat generation may result in the Characteristics decline, such as brightness decreased, Color changed and so on. Please consider the heat generation of the LEDs when making the system design.

使用注意事项 (3)

Precautions (3)

4. 其他事项:

Others

直接用手拿取产品不但会污染封装树脂表面,也可能由于静电等因素导致产品性能的改变。过度的压力也可能直接影响封装内部的管芯和金线,因此请勿对产品施加过度压力,特别当产品处于高温状态下,例如在回流焊接过程中。

When handling the product, touching the encapsulant with bare hands will not only contaminate its surface, but also affect on its optical characteristics. Excessive force to the encapsulant might result in catastrophic failure of the LEDs due to die breakage or wire deformation. For this reason, please do not put excessive stress on LEDs, especially when the LEDs are heated such as during Reflow Soldering.

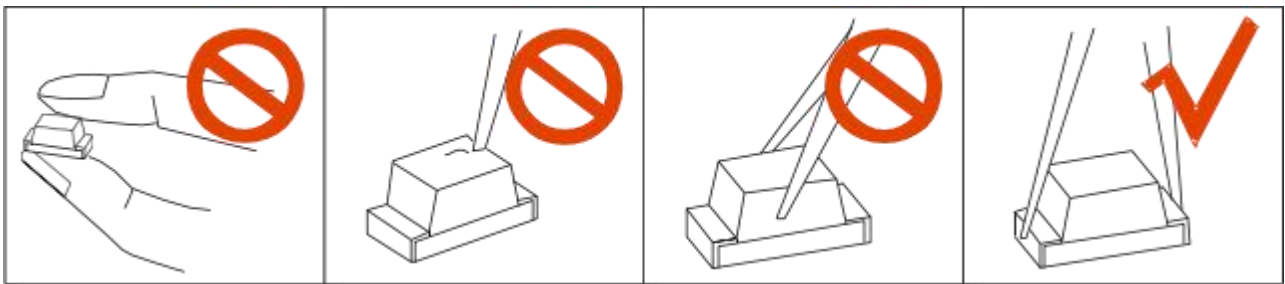

LED 的环氧树脂封装部分相当脆弱,请勿用坚硬、尖锐的物体刮、擦封装树脂部分。在用镊子夹取的时候也应当小心注意。

The epoxy resin of encapsulant is fragile, so please avoid scratch or friction over the epoxy resin surface.

While handling the product with tweezers, do not hold by the epoxy resin, be careful.

5. 眼睛保护忠告:

Safety Advice For Human Eyes

LED 发光时,请勿直视发光光源,特别是对于一些光强较高的 LED,强光可能伤害你的眼睛。

Viewing direct to the light emitting center of the LEDs, especially those of great Luminous Intensity, will cause great hazard to human eyes. Please be careful.