

MM74HCT273

Octal D-Type Flip-Flop with Clear

General Description

The MM74HCT273 utilizes advanced silicon-gate CMOS technology. It has an input threshold and output drive similar to LS-TTL with the low standby power of CMOS.

These positive edge-triggered flip-flops have a common clock and clear-independent Q outputs. Data on a D input, having the specified set-up and hold time, is transferred to the corresponding Q output on the positive-going transition of the clock pulse. The asynchronous clear forces all outputs LOW when it is LOW.

All inputs to this device are protected from damage due to electrostatic discharge by diodes to V_{CC} and ground.

MM74HCT devices are intended to interface TTL and NMOS components to CMOS components. These parts can be used as plug-in replacements to reduce system power consumption in existing designs.

Features

- Typical propagation delay: 20 ns
- Low quiescent current: 80 μ A maximum (74HCT series)
- Fanout of 10 LS-TTL loads

Ordering Code:

Order Number	Package Number	Package Description
MM74HCT273WM	M20B	20-Lead Small Outline Integrated Circuit (SOIC), JEDEC MS-013, 0.300" Wide
MM74HCT273SJ	M20D	20-Lead Small Outline Package (SOP), EIAJ TYPE II, 5.3mm Wide
MM74HCT273MTC	MTC20	20-Lead Thin Shrink Small Outline Package (TSSOP), JEDEC MO-153, 4.4mm Wide
MM74HCT273N	N20A	20-Lead Plastic Dual-In-Line Package (PDIP), JEDEC MS-001, 0.300" Wide

Devices also available in Tape and Reel. Specify by appending the suffix letter "X" to the ordering code.

Connection Diagram

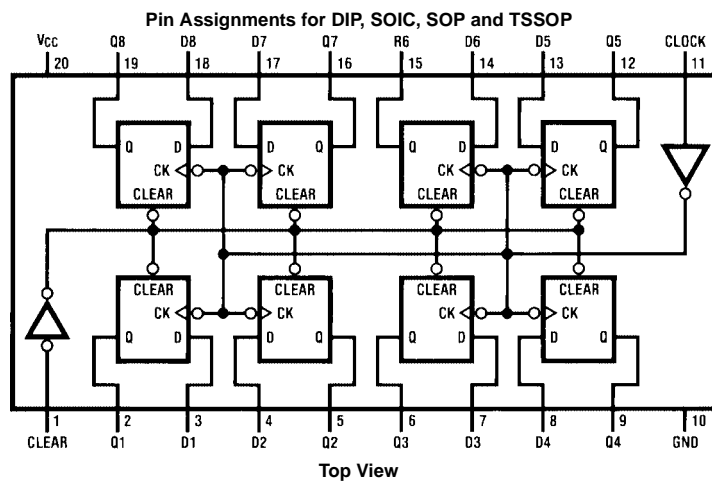

Truth Table

(Each Flip-Flop)

Inputs			Outputs
Clear	Clock	D	Q
L	X	X	L
H	↑	H	H
H	↑	L	L
H	L	X	Q0

H = HIGH Level (steady-state)
 L = LOW Level (steady-state)
 X = Don't Care
 ↑ = Transition from LOW-to-HIGH level
 Q0 = The level of Q before the indicated steady-state input conditions were established.

Logic Diagram

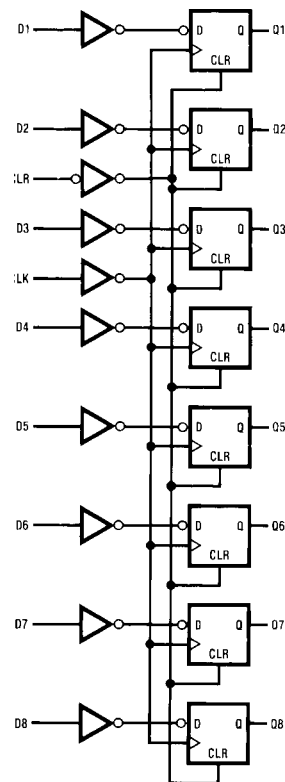

Absolute Maximum Ratings(Note 1)

(Note 2)

Supply Voltage (V_{CC})	-0.5V to + 7.0V
DC Input Voltage (V_{IN})	-1.5V to $V_{CC} + 1.5V$
DC Output Voltage (V_{OUT})	-0.5V to $V_{CC} + 0.5V$
Clamp Diode Current (I_{IK}, I_{OK})	± 20 mA
DC Output Current, per Pin (I_{OUT})	± 25 mA
DC V_{CC} or GND Current, per Pin (I_{CC})	± 50 mA
Storage Temperature Range (T_{STG})	-65°C to + 150°C
Power Dissipation (P_D)	
(Note 3)	600 mW
S.O. Package only	500 mW
Lead Temperature (T_L)	
(Soldering, 10 seconds)	260°C

Recommended Operating Conditions

	Min	Max	Units
Supply Voltage (V_{CC})	4.5	5.5	V
DC Input or Output Voltage (V_{IN}, V_{OUT})	0	V_{CC}	V
Operating Temperature Range (T_A)	-40	+85	°C
Input Rise or Fall Times (t_r, t_f)		500	ns

Note 1: Absolute Maximum Ratings are those values beyond which damage to the device may occur.

Note 2: Unless otherwise specified all voltages are referenced to ground.

Note 3: Power dissipation temperature derating—plastic "N" package: -12 mW/°C from 65°C to 85°C.

DC Electrical Characteristics

$V_{CC} = 5V \pm 10\%$ unless otherwise specified

Symbol	Parameter	Conditions	$T_A = 25^\circ\text{C}$		$T_A = -40^\circ\text{C to } 85^\circ\text{C}$	$T_A = -55^\circ\text{C to } 125^\circ\text{C}$	Units
			Typ	Guaranteed Limits			
V_{IH}	Minimum HIGH Level Input Voltage			2.0	2.0	2.0	V
V_{IL}	Maximum LOW Level Input Voltage			0.8	0.8	0.8	V
V_{OH}	Minimum HIGH Level Output Voltage	$V_{IN} = V_{IH}$ or V_{IL}	V_{CC}	$V_{CC}-0.1$	$V_{CC}-0.1$	$V_{CC}-0.1$	V
		$ I_{OUT} = 20 \mu\text{A}$	4.2	3.98	3.84	3.7	V
		$ I_{OUT} = 4.0 \text{ mA}, V_{CC} = 4.5\text{V}$ $ I_{OUT} = 4.8 \text{ mA}, V_{CC} = 5.5\text{V}$	5.2	4.98	4.84	4.7	V
V_{OL}	Minimum LOW Level Voltage	$V_{IN} = V_{IH}$ or V_{IL}	0	0.1	0.1	0.1	V
		$ I_{OUT} = 20 \mu\text{A}$	0.2	0.26	0.33	0.4	V
		$ I_{OUT} = 4.0 \text{ mA}, V_{CC} = 4.5\text{V}$ $ I_{OUT} = 4.8 \text{ mA}, V_{CC} = 5.5\text{V}$	0.2	0.26	0.33	0.4	V
I_{IN}	Maximum Input Current	$V_{IN} = V_{CC}$ or GND, V_{IH} or V_{IL}		± 0.1	± 1.0	± 1.0	μA
I_{CC}	Maximum Quiescent Supply Current	$V_{IN} = V_{CC}$ or GND $I_{OUT} = 0 \mu\text{A}$		8	80	160	μA
		$V_{IN} = 2.4\text{V}$ or 0.5V (Note 4)		0.6	0.8	0.9	mA

Note 4: Measured per pin, all other inputs held at V_{CC} or GND.

AC Electrical Characteristics

$V_{CC} = 5V$, $T_A = 25^\circ C$, $C_L = 15$ pF, $t_r = t_f = 6$ ns

Symbol	Parameter	Conditions	Typ	Guaranteed Limits	Units
f_{MAX}	Maximum Operating Frequency		68	30	MHz
t_{PHL} , t_{PLH}	Maximum Propagation Delay from Clock to Q		18	30	ns
t_{PHL} , t_{PLH}	Maximum Propagation Delay from Clear to Q		21	30	ns
t_{REM}	Minimum Removal Time, Clear to Clock		-1	5	ns
t_S	Minimum Set-Up Time D to Clock		6	20	ns
t_H	Minimum Hold Time Clock to D		-3	5	ns
t_W	Minimum Pulse Width Clock or Clear		10	16	ns

AC Electrical Characteristics

$V_{CC} = 5.0V \pm 10\%$, $C_L = 50$ pF, $t_r = t_f = 6$ ns unless otherwise specified

Symbol	Parameter	Conditions	$T_A = 25^\circ C$		$T_A = -40^\circ C$ to $85^\circ C$	$T_A = -55^\circ C$ to $125^\circ C$	Units
			Typ	Guaranteed Limits			
f_{MAX}	Maximum Operating Frequency		68	27	21	18	MHz
t_{PHL} , t_{PLH}	Maximum Propagation Delay from Clock to Q		22	37	46	56	ns
t_{PHL} , t_{PLH}	Maximum Propagation Delay from Clear to Q		25	35	44	52	ns
t_{REM}	Minimum Removal Time Clear to Clock		-1	5	6	7	ns
t_S	Minimum Set-Up Time D to Clock		6	20	25	30	ns
t_H	Minimum Hold Time Clock to D		-3	5	5	5	ns
t_W	Minimum Pulse Width Clock or Clear		10	16	25	30	ns
t_r , t_f	Maximum Input Rise and Fall Time, Clock			500	500	500	ns
t_{THL} , t_{TLH}	Maximum Output Rise and Fall Time		11	15	19	22	ns
C_{PD}	Power Dissipation Capacitance (Note 5)	(Per Flip-Flop)	50				pF
C_{IN}	Maximum Input Capacitance		6	10	10	10	pF

Note 5: C_{PD} determines the no load dynamic power consumption, $P_D = C_{PD} V_{CC}^2 f + I_{CC} V_{CC}$, and the no load dynamic current consumption, $I_S = C_{PD} V_{CC}^2 f + I_{CC}$.

Physical Dimensions inches (millimeters) unless otherwise noted



**20-Lead Small Outline Integrated Circuit (SOIC), JEDEC MS-013, 0.300" Wide
Package Number M20B**

Physical Dimensions inches (millimeters) unless otherwise noted (Continued)

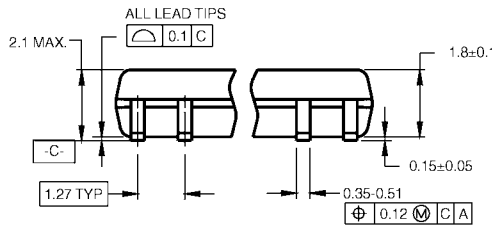

DIMENSIONS ARE IN MILLIMETERS

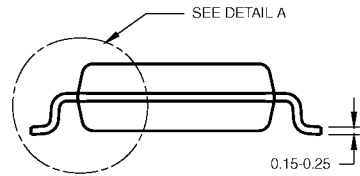

- NOTES:
- A. CONFORMS TO EIAJ EDR-7320 REGISTRATION, ESTABLISHED IN DECEMBER, 1998.
 - B. DIMENSIONS ARE IN MILLIMETERS.
 - C. DIMENSIONS ARE EXCLUSIVE OF BURRS, MOLD FLASH, AND TIE BAR EXTRUSIONS.

M20DRevB1



DETAIL A

**20-Lead Small Outline Package (SOP), EIAJ TYPE II, 5.3mm Wide
Package Number M20D**

Physical Dimensions inches (millimeters) unless otherwise noted (Continued)

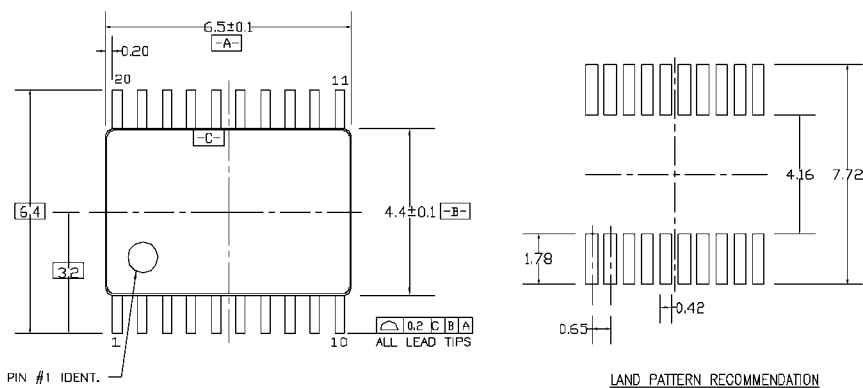

PIN #1 IDENT.

LAND PATTERN RECOMMENDATION

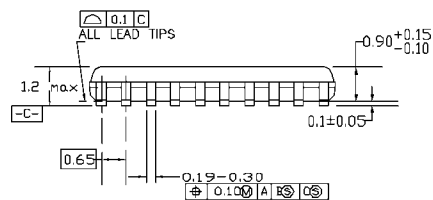

DIMENSIONS ARE IN MILLIMETERS

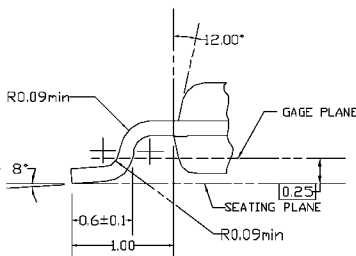
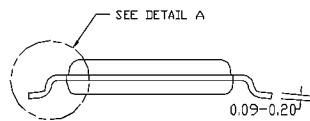

DETAIL A

NOTES:

- A. CONFORMS TO JEDEC REGISTRATION MO-153, VARIATION AC, REF NOTE 6, DATE 7/93.
- B. DIMENSIONS ARE IN MILLIMETERS.
- C. DIMENSIONS ARE EXCLUSIVE OF BURRS, MOLDS FLASH, AND TIE BAR EXTRUSIONS.
- D. DIMENSIONS AND TOLERANCES PER ANSI Y14.5M, 1982.

MTC20REVD1

20-Lead Thin Shrink Small Outline Package (TSSOP), JEDEC MO-153, 4.4mm Wide Package Number MTC20

Physical Dimensions inches (millimeters) unless otherwise noted (Continued)

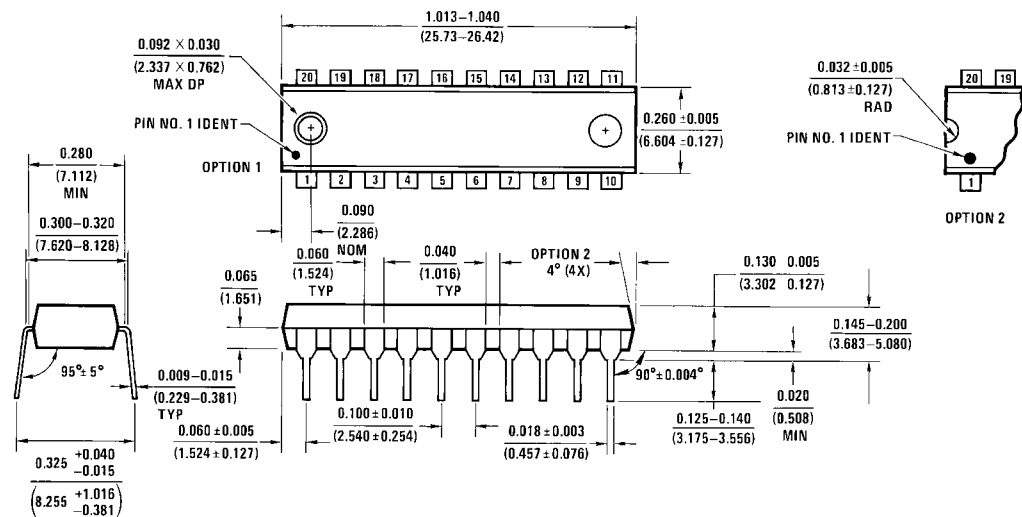

N20A (REV G)

20-Lead Plastic Dual-In-Line Package (PDIP), JEDEC MS-001, 0.300" Wide Package Number N20A

Fairchild does not assume any responsibility for use of any circuitry described, no circuit patent licenses are implied and Fairchild reserves the right at any time without notice to change said circuitry and specifications.

LIFE SUPPORT POLICY

FAIRCHILD'S PRODUCTS ARE NOT AUTHORIZED FOR USE AS CRITICAL COMPONENTS IN LIFE SUPPORT DEVICES OR SYSTEMS WITHOUT THE EXPRESS WRITTEN APPROVAL OF THE PRESIDENT OF FAIRCHILD SEMICONDUCTOR CORPORATION. As used herein:

1. Life support devices or systems are devices or systems which, (a) are intended for surgical implant into the body, or (b) support or sustain life, and (c) whose failure to perform when properly used in accordance with instructions for use provided in the labeling, can be reasonably expected to result in a significant injury to the user.
2. A critical component in any component of a life support device or system whose failure to perform can be reasonably expected to cause the failure of the life support device or system, or to affect its safety or effectiveness.

www.fairchildsemi.com