



CJ78L00C Series Three Terminal Positive Regulators

1 Introduction

The CJ78L00C series is a group of three terminal positive voltage linear regulators with fixed voltage output. Its input voltage can reach up to 30V (or 35V) and can deliver output current up to 100mA with good power dissipation. The CJ78L00C series adopts fixed voltage output and no peripheral resistance, improving the space utilization efficiency of printed circuit boards (PCBs). In addition, the CJ78L00C series also integrates internal current limiting, thermal shutdown, and safe-area compensation, which helps protect the device from overload. Therefore, the CJ78L00C series is widely used in various scenarios, such as on card adjustment, to eliminate noise and distribution issues related to single point supervision. When used as a substitute for Zener diode resistor combinations, it can effectively increase output impedance and reduce bias current.

2 Available Packages

PART NUMBER	PACKAGE
CJ78L00C Series	SOT-23-3L
	SOT-89-3L
	TO-92

Note: For all available packages, please refer to the part *Orderable Information*.

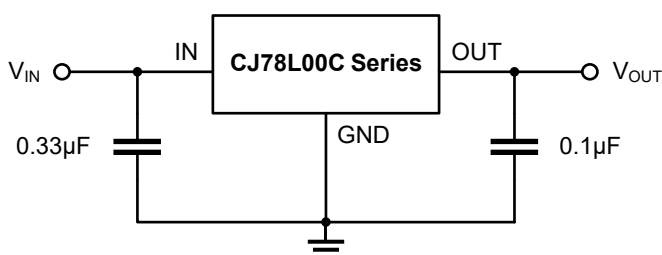

Figure 2-1. Typical Application Circuit

3 Features

- Available Output Voltage:
 - 5.0V: CJ78L05C
 - 6.0V: CJ78L06C
 - 8.0V: CJ78L08C
 - 9.0V: CJ78L09C
 - 12V: CJ78L12C
 - 15V: CJ78L15C
 - 18V: CJ78L18C
- Maximum Input Voltage:
 - 30V for $V_{OUT} < 10V$
 - 35V for $V_{OUT} > 10V$
- Maximum Output Current:
 - up to 100mA
- Operating Junction Temperature:
 - 40 ~ 125°C
- Output Voltage Tolerances at $T_J = 25^\circ C$:
 - ±3% for Conventional Device
 - ±2% can be Customized
- Output Voltage Tolerances of ±5% over the Temperature Range
- No External Components
- Build-in Current Limit
- Thermal Shutdown Protection
- Output Transistor Safe-Area Protection

4 Applications

- Chemical or Gas Sensors
- Computing and Servers
- Field Transmitter: Temperature Sensors
- Flow Meters
- On-Card Regulation
- Telecommunications
- White Goods

5 Orderable Information

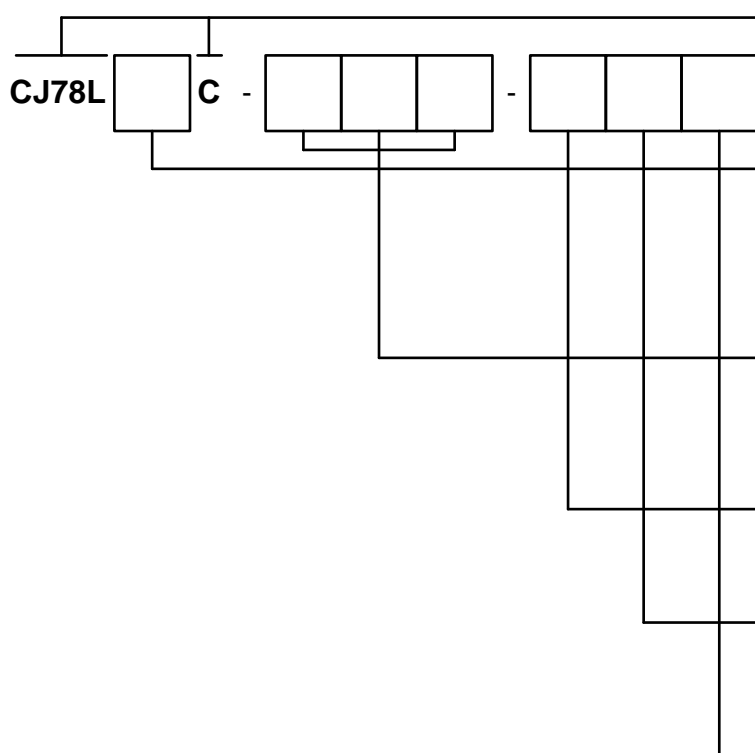

Device serial number.

Output voltage.

- 05: Fixed output 5.0V
- 06: Fixed output 6.0V
- 08: Fixed output 8.0V
- 09: Fixed output 9.0V
- 12: Fixed output 12V
- 15: Fixed output 15V
- 18: Fixed output 18V

Package type.

- M3Y: SOT-23-3L
- P3T: SOT-89-3L
- TAB: TO-92

Output voltage tolerances.

- A: ±3% grade
- B: ±2% grade

Outer package option.

- A: Ammo
- B: Bulk
- R: Tape and reel

Eco-label.

- G: Green device, halogen free and lead free

Figure 5-1. CJ78L00C Series Naming Convention

MODEL	DEVICE	PACKAGE	OP T _J	ECO PLAN	MSL	PACKING OPTION	SORT
±3% Grade Products							
CJ78L00C-5.0	CJ78L05C-M3Y-ARG	SOT-23-3L	-40 ~ 125°C	RoHS & Green	Level 3 168 HR	Tape and Reel 3000 Units / Reel	Active
CJ78L00C-5.0	CJ78L05C-P3T-ARG	SOT-89-3L	-40 ~ 125°C	RoHS & Green	Level 1 Infinite	Tape and Reel 1000 Units / Reel	Active
CJ78L00C-6.0	CJ78L06C-P3T-ARG	SOT-89-3L	-40 ~ 125°C	RoHS & Green	Level 1 Infinite	Tape and Reel 1000 Units / Reel	Active
CJ78L00C-8.0	CJ78L08C-P3T-ARG	SOT-89-3L	-40 ~ 125°C	RoHS & Green	Level 1 Infinite	Tape and Reel 1000 Units / Reel	Active
CJ78L00C-9.0	CJ78L09C-P3T-ARG	SOT-89-3L	-40 ~ 125°C	RoHS & Green	Level 1 Infinite	Tape and Reel 1000 Units / Reel	Active
CJ78L00C-12	CJ78L12C-P3T-ARG	SOT-89-3L	-40 ~ 125°C	RoHS & Green	Level 1 Infinite	Tape and Reel 1000 Units / Reel	Active
CJ78L00C-15	CJ78L15C-P3T-ARG	SOT-89-3L	-40 ~ 125°C	RoHS & Green	Level 1 Infinite	Tape and Reel 1000 Units / Reel	Active
CJ78L00C-18	CJ78L18C-P3T-ARG	SOT-89-3L	-40 ~ 125°C	RoHS & Green	Level 1 Infinite	Tape and Reel 1000 Units / Reel	Active

5 Orderable Information

MODEL	DEVICE	PACKAGE	OP T _J	ECO PLAN	MSL	PACKING OPTION	SORT
±3% Grade Products (continued)							
CJ78L00C-5.0	CJ78L05C-TAB-AAG	TO-92	-40 ~ 125°C	RoHS & Green	Level 3 168 HR	Ammo 2000 Units / Box	Active
CJ78L00C-6.0	CJ78L06C-TAB-AAG	TO-92	-40 ~ 125°C	RoHS & Green	Level 3 168 HR	Ammo 2000 Units / Box	Active
CJ78L00C-8.0	CJ78L08C-TAB-AAG	TO-92	-40 ~ 125°C	RoHS & Green	Level 3 168 HR	Ammo 2000 Units / Box	Active
CJ78L00C-9.0	CJ78L09C-TAB-AAG	TO-92	-40 ~ 125°C	RoHS & Green	Level 3 168 HR	Ammo 2000 Units / Box	Active
CJ78L00C-12	CJ78L12C-TAB-AAG	TO-92	-40 ~ 125°C	RoHS & Green	Level 3 168 HR	Ammo 2000 Units / Box	Active
CJ78L00C-15	CJ78L15C-TAB-AAG	TO-92	-40 ~ 125°C	RoHS & Green	Level 3 168 HR	Ammo 2000 Units / Box	Active
CJ78L00C-18	CJ78L18C-TAB-AAG	TO-92	-40 ~ 125°C	RoHS & Green	Level 3 168 HR	Ammo 2000 Units / Box	Active
CJ78L00C-5.0	CJ78L05C-TAB-ABG	TO-92	-40 ~ 125°C	RoHS & Green	Level 3 168 HR	Bulk 1000 Units / Bag	Active
CJ78L00C-6.0	CJ78L06C-TAB-ABG	TO-92	-40 ~ 125°C	RoHS & Green	Level 3 168 HR	Bulk 1000 Units / Bag	Active
CJ78L00C-8.0	CJ78L08C-TAB-ABG	TO-92	-40 ~ 125°C	RoHS & Green	Level 3 168 HR	Bulk 1000 Units / Bag	Active
CJ78L00C-9.0	CJ78L09C-TAB-ABG	TO-92	-40 ~ 125°C	RoHS & Green	Level 3 168 HR	Bulk 1000 Units / Bag	Active
CJ78L00C-12	CJ78L12C-TAB-ABG	TO-92	-40 ~ 125°C	RoHS & Green	Level 3 168 HR	Bulk 1000 Units / Bag	Active
CJ78L00C-15	CJ78L15C-TAB-ABG	TO-92	-40 ~ 125°C	RoHS & Green	Level 3 168 HR	Bulk 1000 Units / Bag	Active
CJ78L00C-18	CJ78L18C-TAB-ABG	TO-92	-40 ~ 125°C	RoHS & Green	Level 3 168 HR	Bulk 1000 Units / Bag	Active

5 Orderable Information

MODEL	DEVICE	PACKAGE	OP T _J	ECO PLAN	MSL	PACKING OPTION	SORT
±2% Grade Products							
CJ78L00C-x.x ±2% grade	CJ78LxxC-M3Y-BRG	SOT-23-3L	-40 ~ 125°C	RoHS & Green	Level 3 168 HR	Tape and Reel 1000 Units / Reel	Customized
	CJ78LxxC-P3T-BRG	SOT-89-3L	-40 ~ 125°C	RoHS & Green	Level 1 Infinite	Tape and Reel 1000 Units / Reel	Customized
	CJ78LxxC-TAB-BAG	TO-92	-40 ~ 125°C	RoHS & Green	Level 3 168 HR	Ammo 2000 Units / Box	Customized
	CJ78LxxC-TAB-BBG	TO-92	-40 ~ 125°C	RoHS & Green	Level 3 168 HR	Bulk 1000 Units / Bag	Customized
Other	-	-	-	-	-	-	Customized

Note:

ECO PLAN: For the RoHS and Green certification standards of this product, please refer to the official report provided by JSCJ.

MSL: Moisture Sensitivity Level. Determined according to JEDEC industry standard classification.

SORT: Specifically defined as follows:

Active: Recommended for new products;

Customized: Products manufactured to meet the specific needs of customers;

Preview: The device has been released and has not been fully mass produced. The sample may or may not be available; NoRD:

It is not recommended to use the device for new design. The device is only produced for the needs of existing customers;

Obsolete: The device has been discontinued.

6 Pin Configuration and Marking Information

6.1 Pin Configuration and Function

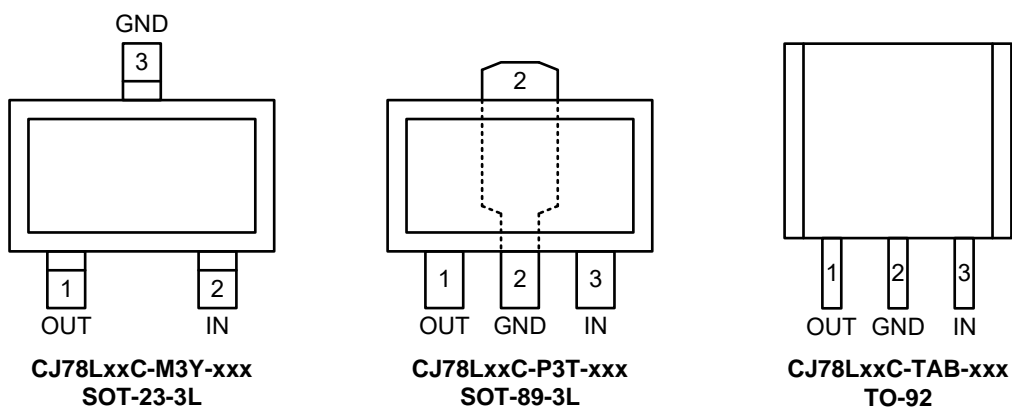
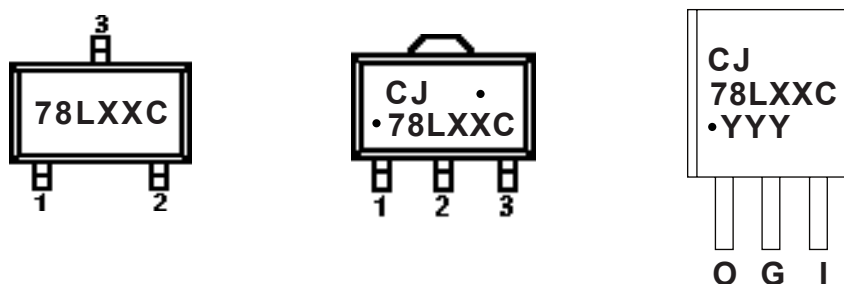

Figure 5-1. Package Top View

PIN NAME	CJ78L00C Series			I / O	DESCRIPTION
	SOT-23-3L	SOT-89-3L	TO-92		
IN	2	3	3	I	Input to the device.
GND	3	2	2	-	Regulator ground.
OUT	1	1	1	O	Output of the regulator.

6.2 Marking Information



"78LXXC" or "CJ78LXXC": Product number, the "XX" in the "78LXXC" or "CJ78LXXC" represents the output voltage, for example, if the $V_{OUT} = 5.0V$, "XX" is "05".

"•" Solid dot: Lower left, represents green molding compound device. Upper right, anchor point.

"YYY": Code.

7 Specifications

7.1 Absolute Maximum Ratings

(over operating free-air temperature range, unless otherwise specified)⁽¹⁾

CHARACTERISTIC		SYMBOL	VALUE	UNIT
Maximum input voltage ⁽²⁾		$V_{IN\ MAX}$	36	V
Maximum power dissipation	CJ78L00C Series	SOT-23-3L	Internally Limited ⁽³⁾	W
		SOT-89-3L		
		TO-92		
Maximum junction temperature		$T_{J\ Max}$	150	°C
Storage temperature		T_{stg}	-65 ~ 150	°C
Soldering temperature & time		T_{solder}	260°C, 10s	-

(1) Stresses beyond those listed under *Absolute Maximum Ratings* may cause permanent damage to the device. These are stress ratings only, which do not imply functional operation of the device at these or any other conditions beyond those indicated under *Recommended Operating Conditions*. Exposure to absolute-maximum rated conditions for extended periods may affect device reliability.

(2) All voltages are with respect to network ground terminal.

(3) Refer to *Thermal Information* for details.

7.2 Recommended Operating Conditions

PARAMETER ⁽⁴⁾		SYMBOL	MIN.	NOM.	MAX.	UNIT
Input voltage range	CJ78L05C	V_{IN}	-	-	30	V
	CJ78L06C		-	-		
	CJ78L08C		-	-		
	CJ78L09C		-	-	35	
	CJ78L12C		-	-		
	CJ78L15C		-	-		
	CJ78L18C		-	-		
Operating junction temperature		T_J	-40	-	125	°C
Operating ambient temperature		T_A	-	-(⁵)	-	°C

(4) It is necessary to ensure that the operating junction temperature of the device does not exceed the rated value of the recommended operating conditions when using the device for design.

7 Specifications

7.3 ESD Ratings

ESD RATINGS		SYMBOL	VALUE	UNIT
Electrostatic discharge ⁽⁶⁾	Human body model	V _{ESD-HBM}	2000	V
	Machine model	V _{ESD-MM}	200	

(5) ESD testing is conducted in accordance with the relevant specifications formulated by the Joint Electronic Equipment Engineering Commission (JEDEC). The human body mode (HBM) electrostatic discharge test is based on the JESD22-114D test standard, using a 100pF capacitor and discharging to each pin of the device through a resistance of 1.5kΩ. The electrostatic discharge test in mechanical mode (MM) is based on the JESD22-115-A test standard and uses a 200pF capacitor to discharge directly to each pin of the device.

7.4 Thermal Information

THERMAL METRIC ⁽⁷⁾	SYMBOL	CJ78L00C Series			UNIT
		SOT-23-3L	SOT-89-3L	TO-92	
Junction-to-ambient thermal resistance	R _{θJA}	260.7	121.6	167.2	°C/W
Junction-to-case thermal resistance	R _{θJC}	64.9	29.4	40.3	°C/W
Reference maximum power dissipation for continuous operation	P _{D Ref}	0.38	0.82	0.60	W

(6) Thermal metric is measured in still air with T_A = 25°C and installed on a 1 in² FR-4 board covered with 2 ounces of copper.

7 Specifications

7.5 Electrical Characteristics

CJ78L05C ($V_{IN} = 10V$, $I_{OUT} = 40mA$, $C_{IN} = 0.33\mu F$, $C_{OUT} = 0.1\mu F$, $T_J = 25^\circ C$, unless otherwise specified)

CHARACTERISTIC	SYMBOL	TEST CONDITIONS ⁽⁷⁾	MIN.	TYP.	MAX.	UNIT	
Input voltage	V_{IN}	-	-	-	30	V	
Output voltage	V_{OUT}	$T_J = 25^\circ C$	$\pm 3\%$ grade ⁽⁸⁾	4.85	5.00	5.15	V
			$\pm 2\%$ grade ⁽⁸⁾	4.90		5.10	
		$V_{IN} = 7$ to $20V$, $I_{OUT} = 1$ to $100mA$, $T_J = -40$ to $125^\circ C$, $P_D \leq 0.75W$	4.75	5.00	5.25		
Output current	I_{OUT}	$T_J = 25^\circ C$	100	-	-	mA	
Quiescent current	I_Q	$I_{OUT} = 0mA$	-	3.0	5.5	mA	
Quiescent current change	ΔI_Q	$V_{IN} = 8$ to $20V$, $T_J = -40$ to $125^\circ C$	-	-	1.5	mA	
		$I_{OUT} = 1$ to $40mA$, $T_J = -40$ to $125^\circ C$	-	-	0.1		
Dropout voltage	$V_{DO}^{(9)}$	$I_{OUT} = 40mA$	-	1.7	2.0	V	
		$I_{OUT} = 100mA$	-	1.8	2.3		
Line regulation	ΔV_{LINE}	$V_{IN} = 7$ to $20V$	-	8	150	mV	
Load regulation	ΔV_{LOAD}	$I_{OUT} = 1$ to $100mA$	-	10	60	mV	
Output voltage temperature coefficient	$\Delta V_{OUT} / \Delta T$	$I_{OUT} = 5mA$	-	0.42	-	mV/ $^\circ C$	
	$\Delta V_{OUT} / (V_{OUT} \times \Delta T)$		-	84	-	ppm/ $^\circ C$	
Output noise voltage	V_N	$f = 10$ to $100k$ Hz ⁽¹⁰⁾	-	40	-	μV	
Ripple rejection	RR	$V_{IN} = 8$ to $18V$, $f = 120Hz$	47	62	-	dB	

Note:

(7) Pulse test technology is used to make T_J as close to T_A as possible. Thermal effects must be considered separately.

(8) Output voltage tolerances of $\pm 3\%$ for conventional device, $\pm 2\%$ can be customized.

(9) The difference of output voltage and input voltage when input voltage is decreased gradually till output voltage equals to 95% of V_{OUT} .

(10) $0.01\mu F$ minimum load capacitance is recommended to limit high frequency noise.

7 Specifications

7.5 Electrical Characteristics (continued)

CJ78L06C ($V_{IN} = 11V$, $I_{OUT} = 40mA$, $C_{IN} = 0.33\mu F$, $C_{OUT} = 0.1\mu F$, $T_J = 25^\circ C$, unless otherwise specified)

CHARACTERISTIC	SYMBOL	TEST CONDITIONS ⁽⁷⁾	MIN.	TYP.	MAX.	UNIT	
Input voltage	V_{IN}	-	-	-	30	V	
Output voltage	V_{OUT}	$T_J = 25^\circ C$	$\pm 3\%$ grade ⁽⁸⁾	5.82	6.00	6.18	V
			$\pm 2\%$ grade ⁽⁸⁾	5.88		6.12	
		$V_{IN} = 8$ to $20V$, $I_{OUT} = 1$ to $100mA$, $T_J = -40$ to $125^\circ C$, $P_D \leq 0.75W$		5.70	6.00	6.30	
Output current	I_{OUT}	$T_J = 25^\circ C$	100	-	-	mA	
Quiescent current	I_Q	$I_{OUT} = 0mA$	-	3.0	5.5	mA	
Quiescent current change	ΔI_Q	$V_{IN} = 9$ to $20V$, $T_J = -40$ to $125^\circ C$	-	-	1.5	mA	
		$I_{OUT} = 1$ to $40mA$, $T_J = -40$ to $125^\circ C$	-	-	0.1		
Dropout voltage	$V_{DO}^{(9)}$	$I_{OUT} = 40mA$	-	1.7	2.0	V	
		$I_{OUT} = 100mA$	-	1.8	2.3		
Line regulation	ΔV_{LINE}	$V_{IN} = 8$ to $20V$	-	8	150	mV	
Load regulation	ΔV_{LOAD}	$I_{OUT} = 1$ to $100mA$	-	10	60	mV	
Output voltage temperature coefficient	$\Delta V_{OUT} / \Delta T$	$I_{OUT} = 5mA$	-	0.50	-	mV/ $^\circ C$	
	$\Delta V_{OUT} / (V_{OUT} \times \Delta T)$		-	84	-	ppm/ $^\circ C$	
Output noise voltage	V_N	$f = 10$ to $100k$ Hz ⁽¹⁰⁾	-	50	-	μV	
Ripple rejection	RR	$V_{IN} = 9$ to $19V$, $f = 120Hz$	47	59	-	dB	

Note:

(7) Pulse test technology is used to make T_J as close to T_A as possible. Thermal effects must be considered separately.

(8) Output voltage tolerances of $\pm 3\%$ for conventional device, $\pm 2\%$ can be customized.

(9) The difference of output voltage and input voltage when input voltage is decreased gradually till output voltage equals to 95% of V_{OUT} .

(10) $0.01\mu F$ minimum load capacitance is recommended to limit high frequency noise.

7 Specifications

7.5 Electrical Characteristics (continued)

CJ78L08C ($V_{IN} = 14V$, $I_{OUT} = 40mA$, $C_{IN} = 0.33\mu F$, $C_{OUT} = 0.1\mu F$, $T_J = 25^\circ C$, unless otherwise specified)

CHARACTERISTIC	SYMBOL	TEST CONDITIONS ⁽⁷⁾		MIN.	TYP.	MAX.	UNIT
Input voltage	V_{IN}	-		-	-	30	V
Output voltage	V_{OUT}	$T_J = 25^\circ C$	$\pm 3\%$ grade ⁽⁸⁾	7.76	8.00	8.24	V
			$\pm 2\%$ grade ⁽⁸⁾	7.84		8.16	
		$V_{IN} = 10.5$ to $23V$, $T_J = -40$ to $125^\circ C$, $I_{OUT} = 1$ to $100mA$, $P_D \leq 0.75W$		7.60	8.00	8.40	
Output current	I_{OUT}	$T_J = 25^\circ C$		100	-	-	mA
Quiescent current	I_Q	$I_{OUT} = 0mA$		-	3.0	5.5	mA
Quiescent current change	ΔI_Q	$V_{IN} = 11$ to $23V$, $T_J = -40$ to $125^\circ C$		-	-	1.5	mA
		$I_{OUT} = 1$ to $40mA$, $T_J = -40$ to $125^\circ C$		-	-	0.1	
Dropout voltage	$V_{DO}^{(9)}$	$I_{OUT} = 40mA$		-	1.7	2.0	V
		$I_{OUT} = 100mA$		-	1.8	2.3	
Line regulation	ΔV_{LINE}	$V_{IN} = 10.5$ to $23V$		-	8	150	mV
Load regulation	ΔV_{LOAD}	$I_{OUT} = 1$ to $100mA$		-	10	70	mV
Output voltage temperature coefficient	$\Delta V_{OUT} / \Delta T$	$I_{OUT} = 5mA$		-	0.62	-	mV/ $^\circ C$
	$\Delta V_{OUT} / (V_{OUT} \times \Delta T)$			-	84	-	ppm/ $^\circ C$
Output noise voltage	V_N	$f = 10$ to $100k$ Hz ⁽¹⁰⁾		-	60	-	μV
Ripple rejection	RR	$V_{IN} = 13$ to $23V$, $f = 120Hz$		44	53	-	dB

Note:

(7) Pulse test technology is used to make T_J as close to T_A as possible. Thermal effects must be considered separately.

(8) Output voltage tolerances of $\pm 3\%$ for conventional device, $\pm 2\%$ can be customized.

(9) The difference of output voltage and input voltage when input voltage is decreased gradually till output voltage equals to 95% of V_{OUT} .

(10) $0.01\mu F$ minimum load capacitance is recommended to limit high frequency noise.

7 Specifications

7.5 Electrical Characteristics (continued)

CJ78L09C ($V_{IN} = 16V$, $I_{OUT} = 40mA$, $C_{IN} = 0.33\mu F$, $C_{OUT} = 0.1\mu F$, $T_J = 25^\circ C$, unless otherwise specified)

CHARACTERISTIC	SYMBOL	TEST CONDITIONS ⁽⁷⁾	MIN.	TYP.	MAX.	UNIT
Input voltage	V_{IN}	-	-	-	30	V
Output voltage	V_{OUT}	$T_J = 25^\circ C$	$\pm 3\%$ grade ⁽⁸⁾	8.73	9.27	V
			$\pm 2\%$ grade ⁽⁸⁾	8.82	9.18	
		$V_{IN} = 12$ to $24V$, $I_{OUT} = 1$ to $100mA$, $T_J = -40$ to $125^\circ C$, $P_D \leq 0.75W$	8.55	9.00	9.45	
Output current	I_{OUT}	$T_J = 25^\circ C$	100	-	-	mA
Quiescent current	I_q	$I_{OUT} = 0mA$	-	3.0	5.5	mA
Quiescent current change	ΔI_q	$V_{IN} = 13$ to $24V$, $T_J = -40$ to $125^\circ C$	-	-	1.5	mA
		$I_{OUT} = 1$ to $40mA$, $T_J = -40$ to $125^\circ C$	-	-	0.1	
Dropout voltage	$V_{DO}^{(9)}$	$I_{OUT} = 40mA$	-	1.7	2.0	V
		$I_{OUT} = 100mA$	-	1.8	2.3	
Line regulation	ΔV_{LINE}	$V_{IN} = 12$ to $24V$	-	8	150	mV
Load regulation	ΔV_{LOAD}	$I_{OUT} = 1$ to $100mA$	-	10	70	mV
Output voltage temperature coefficient	$\Delta V_{OUT} / \Delta T$	$I_{OUT} = 5mA$	-	0.70	-	mV/ $^\circ C$
	$\Delta V_{OUT} / (V_{OUT} \times \Delta T)$		-	84	-	ppm/ $^\circ C$
Output noise voltage	V_N	$f = 10$ to $100k$ Hz ⁽¹⁰⁾	-	65	-	μV
Ripple rejection	RR	$V_{IN} = 15$ to $25V$, $f = 120Hz$	42	51	-	dB

Note:

(7) Pulse test technology is used to make T_J as close to T_A as possible. Thermal effects must be considered separately.

(8) Output voltage tolerances of $\pm 3\%$ for conventional device, $\pm 2\%$ can be customized.

(9) The difference of output voltage and input voltage when input voltage is decreased gradually till output voltage equals to 95% of V_{OUT} .

(10) 0.01 μF minimum load capacitance is recommended to limit high frequency noise.

7 Specifications

7.5 Electrical Characteristics (continued)

CJ78L12C ($V_{IN} = 19V$, $I_{OUT} = 40mA$, $C_{IN} = 0.33\mu F$, $C_{OUT} = 0.1\mu F$, $T_J = 25^\circ C$, unless otherwise specified)

CHARACTERISTIC	SYMBOL	TEST CONDITIONS ⁽⁷⁾	MIN.	TYP.	MAX.	UNIT	
Input voltage	V_{IN}	-	-	-	35	V	
Output voltage	V_{OUT}	$T_J = 25^\circ C$	$\pm 3\%$ grade ⁽⁸⁾	11.64	12.00	12.36	V
			$\pm 2\%$ grade ⁽⁸⁾	11.76		12.24	
		$V_{IN} = 14.5$ to $27V$, $T_J = -40$ to $125^\circ C$, $I_{OUT} = 1$ to $100mA$, $P_D \leq 0.75W$		11.40	12.00	12.60	
Output current	I_{OUT}	$T_J = 25^\circ C$	100	-	-	mA	
Quiescent current	I_Q	$I_{OUT} = 0mA$	-	3.0	6.0	mA	
Quiescent current change	ΔI_Q	$V_{IN} = 16$ to $27V$, $T_J = -40$ to $125^\circ C$	-	-	1.5	mA	
		$I_{OUT} = 1$ to $40mA$, $T_J = -40$ to $125^\circ C$	-	-	0.1		
Dropout voltage	$V_{DO}^{(9)}$	$I_{OUT} = 40mA$	-	1.7	2.0	V	
		$I_{OUT} = 100mA$	-	1.8	2.3		
Line regulation	ΔV_{LINE}	$V_{IN} = 14.5$ to $27V$	-	20	250	mV	
Load regulation	ΔV_{LOAD}	$I_{OUT} = 1$ to $100mA$	-	20	100	mV	
Output voltage temperature coefficient	$\Delta V_{OUT} / \Delta T$	$I_{OUT} = 5mA$	-	1.00	-	mV/ $^\circ C$	
	$\Delta V_{OUT} / (V_{OUT} \times \Delta T)$		-	84	-	ppm/ $^\circ C$	
Output noise voltage	V_N	$f = 10$ to $100k$ Hz ⁽¹⁰⁾	-	80	-	μV	
Ripple rejection	RR	$V_{IN} = 15$ to $25V$, $f = 120Hz$	37	42	-	dB	

Note:

(7) Pulse test technology is used to make T_J as close to T_A as possible. Thermal effects must be considered separately.

(8) Output voltage tolerances of $\pm 3\%$ for conventional device, $\pm 2\%$ can be customized.

(9) The difference of output voltage and input voltage when input voltage is decreased gradually till output voltage equals to 95% of V_{OUT} .

(10) $0.01\mu F$ minimum load capacitance is recommended to limit high frequency noise.

7 Specifications

7.5 Electrical Characteristics (continued)

CJ78L15C ($V_{IN} = 23V$, $I_{OUT} = 40mA$, $C_{IN} = 0.33\mu F$, $C_{OUT} = 0.1\mu F$, $T_J = 25^\circ C$, unless otherwise specified)

CHARACTERISTIC	SYMBOL	TEST CONDITIONS ⁽⁸⁾	MIN.	TYP.	MAX.	UNIT	
Input voltage	V_{IN}	-	-	-	35	V	
Output voltage	V_{OUT}	$T_J = 25^\circ C$	$\pm 3\%$ grade ⁽⁹⁾	14.55	15.00	15.45	V
			$\pm 2\%$ grade ⁽⁹⁾	14.70		15.30	
		$V_{IN} = 17.5$ to $30V$, $T_J = -40$ to $125^\circ C$, $I_{OUT} = 1$ to $100mA$, $P_D \leq 0.75W$		14.25	15.00	15.75	
Output current	I_{OUT}	$T_J = 25^\circ C$	100	-	-	mA	
Quiescent current	I_Q	$I_{OUT} = 0mA$	-	3.0	6.0	mA	
Quiescent current change	ΔI_Q	$V_{IN} = 20$ to $30V$, $T_J = -40$ to $125^\circ C$	-	-	1.5	mA	
		$I_{OUT} = 1$ to $40mA$, $T_J = -40$ to $125^\circ C$	-	-	0.1		
Dropout voltage	$V_{DO}^{(10)}$	$I_{OUT} = 40mA$	-	1.7	2.0	V	
		$I_{OUT} = 100mA$	-	1.8	2.3		
Line regulation	ΔV_{LINE}	$V_{IN} = 17.5$ to $30V$	-	25	250	mV	
Load regulation	ΔV_{LOAD}	$I_{OUT} = 1$ to $100mA$	-	25	150	mV	
Output voltage temperature coefficient	$\Delta V_{OUT} / \Delta T$	$I_{OUT} = 5mA$	-	1.25	-	mV/ $^\circ C$	
	$\Delta V_{OUT} / (V_{OUT} \times \Delta T)$		-	84	-	ppm/ $^\circ C$	
Output noise voltage	V_N	$f = 10$ to $100k$ Hz ⁽¹⁰⁾	-	90	-	μV	
Ripple rejection	RR	$V_{IN} = 18.5$ to $28.5V$, $f = 120Hz$	34	39	-	dB	

Note:

(7) Pulse test technology is used to make T_J as close to T_A as possible. Thermal effects must be considered separately.

(8) Output voltage tolerances of $\pm 3\%$ for conventional device, $\pm 2\%$ can be customized.

(9) The difference of output voltage and input voltage when input voltage is decreased gradually till output voltage equals to 95% of V_{OUT} .

(10) $0.01\mu F$ minimum load capacitance is recommended to limit high frequency noise.

7 Specifications

7.5 Electrical Characteristics (continued)

CJ78L18C ($V_{IN} = 26V$, $I_{OUT} = 40mA$, $C_{IN} = 0.33\mu F$, $C_{OUT} = 0.1\mu F$, $T_J = 25^\circ C$, unless otherwise specified)

CHARACTERISTIC	SYMBOL	TEST CONDITIONS ⁽⁸⁾		MIN.	TYP.	MAX.	UNIT
Input voltage	V_{IN}	-		-	-	35	V
Output voltage	V_{OUT}	$T_J = 25^\circ C$	$\pm 3\%$ grade ⁽⁹⁾	17.46	18.00	18.54	V
			$\pm 2\%$ grade ⁽⁹⁾	17.64		18.36	
		$V_{IN} = 20.5$ to $33V$, $T_J = -40$ to $125^\circ C$, $I_{OUT} = 1$ to $100mA$, $P_D \leq 0.75W$			17.10	18.00	
Output current	I_{OUT}	$T_J = 25^\circ C$		100	-	-	mA
Quiescent current	I_Q	$I_{OUT} = 0mA$		-	3.0	6.0	mA
Quiescent current change	ΔI_Q	$V_{IN} = 22$ to $33V$, $T_J = -40$ to $125^\circ C$		-	-	1.5	mA
		$I_{OUT} = 1$ to $40mA$, $T_J = -40$ to $125^\circ C$		-	-	0.1	
Dropout voltage	$V_{DO}^{(10)}$	$I_{OUT} = 40mA$		-	1.7	2.0	V
		$I_{OUT} = 100mA$		-	1.8	2.3	
Line regulation	ΔV_{LINE}	$V_{IN} = 20.5$ to $33V$		-	25	250	mV
Load regulation	ΔV_{LOAD}	$I_{OUT} = 1$ to $100mA$		-	25	150	mV
Output voltage temperature coefficient	$\Delta V_{OUT} / \Delta T$	$I_{OUT} = 5mA$		-	1.50	-	mV/ $^\circ C$
	$\Delta V_{OUT} / (V_{OUT} \times \Delta T)$			-	84	-	ppm/ $^\circ C$
Output noise voltage	V_N	$f = 10$ to $100k$ Hz ⁽¹⁰⁾		-	100	-	μV
Ripple rejection	RR	$V_{IN} = 21.5$ to $31.5V$, $f = 120Hz$		34	39	-	dB

Note:

(7) Pulse test technology is used to make T_J as close to T_A as possible. Thermal effects must be considered separately.

(8) Output voltage tolerances of $\pm 3\%$ for conventional device, $\pm 2\%$ can be customized.

(9) The difference of output voltage and input voltage when input voltage is decreased gradually till output voltage equals to 95% of V_{OUT} .

(10) $0.01\mu F$ minimum load capacitance is recommended to limit high frequency noise.

7 Specifications

7.6 Typical Characteristics

CJ78L00C Series ($V_{IN} = 10V$ for CJ78L05C, $V_{IN} = 14.5V$ for CJ78L12C, $V_{IN} = 23V$ for CJ78L15C, $I_{OUT} = 40mA$, $C_{IN} = 0.33\mu F$, $C_{OUT} = 0.1\mu F$, $T_A = 25^\circ C$, unless otherwise specified)

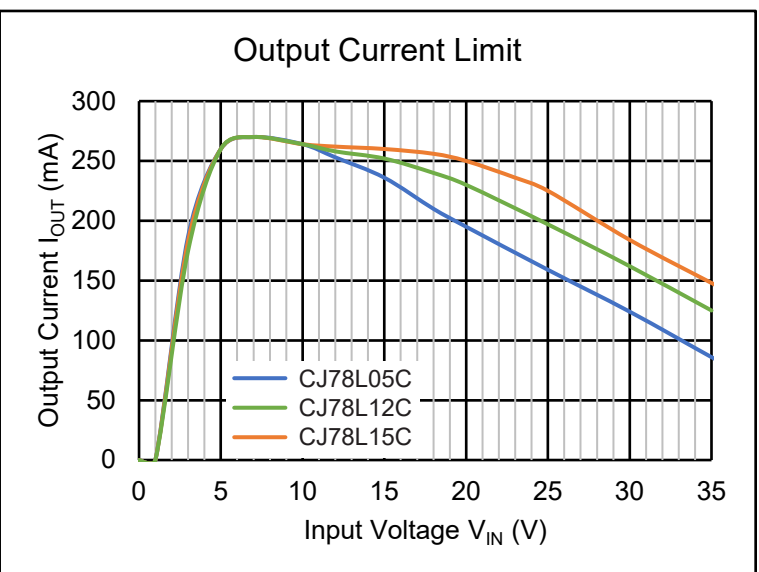
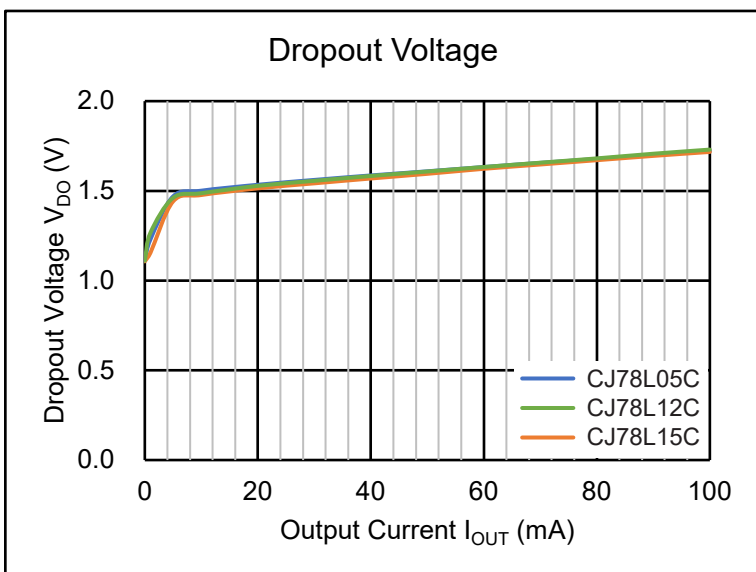
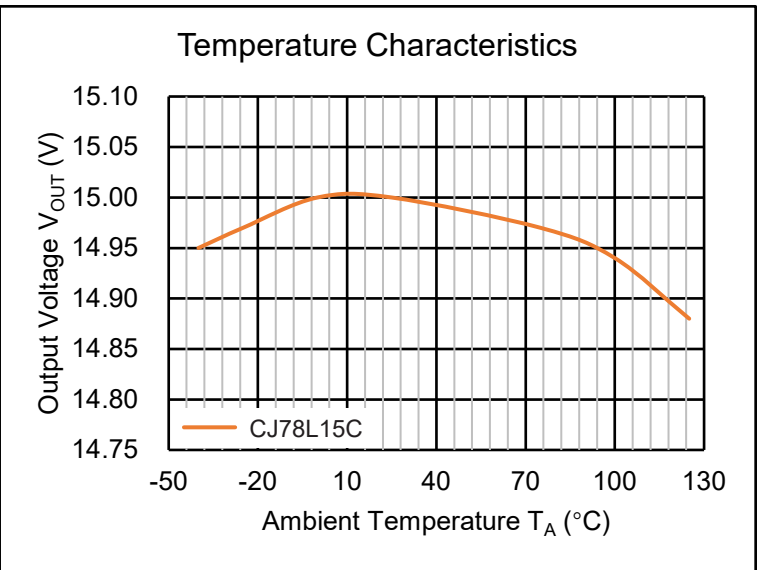
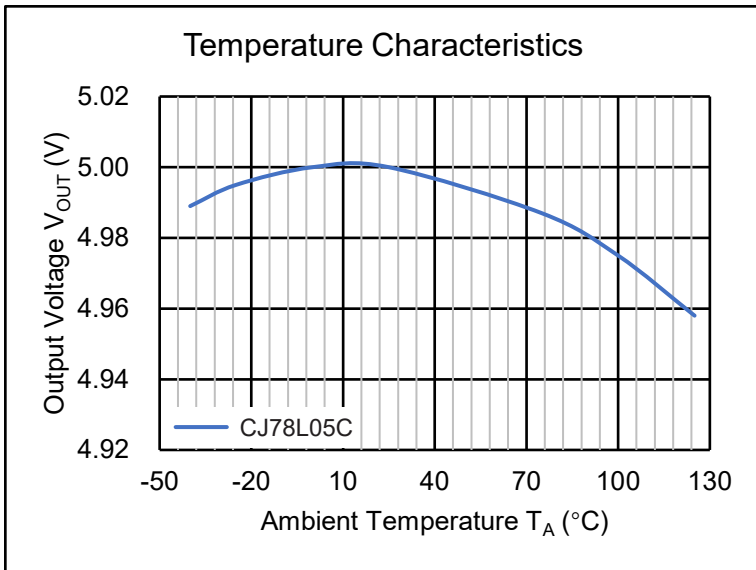
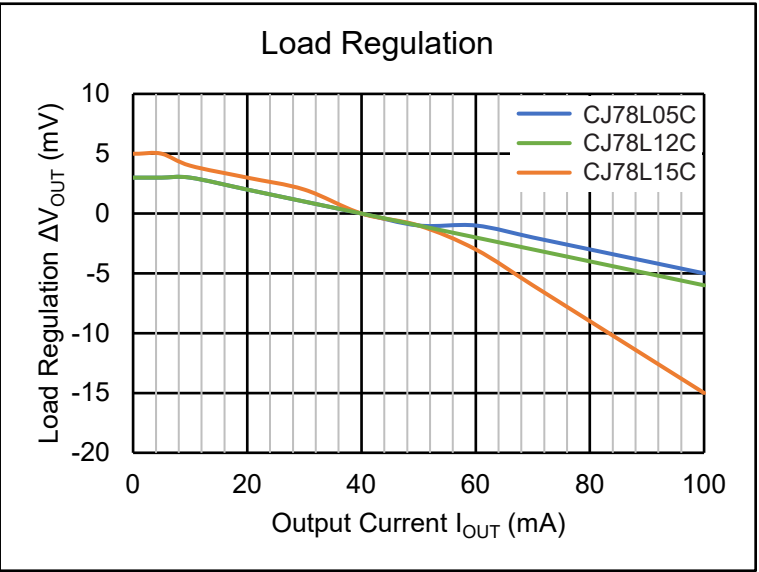
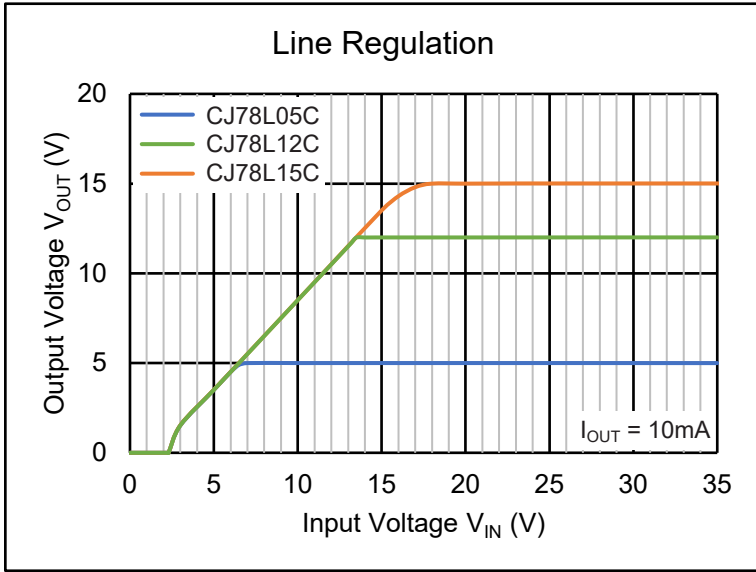

7 Specifications

7.6 Typical Characteristics (continued)

CJ78L00C Series ($V_{IN} = 10V$ for CJ78L05C, $V_{IN} = 14.5V$ for CJ78L12C, $V_{IN} = 23V$ for CJ78L15C, $I_{OUT} = 40mA$, $C_{IN} = 0.33\mu F$, $C_{OUT} = 0.1\mu F$, $T_A = 25^\circ C$, unless otherwise specified)

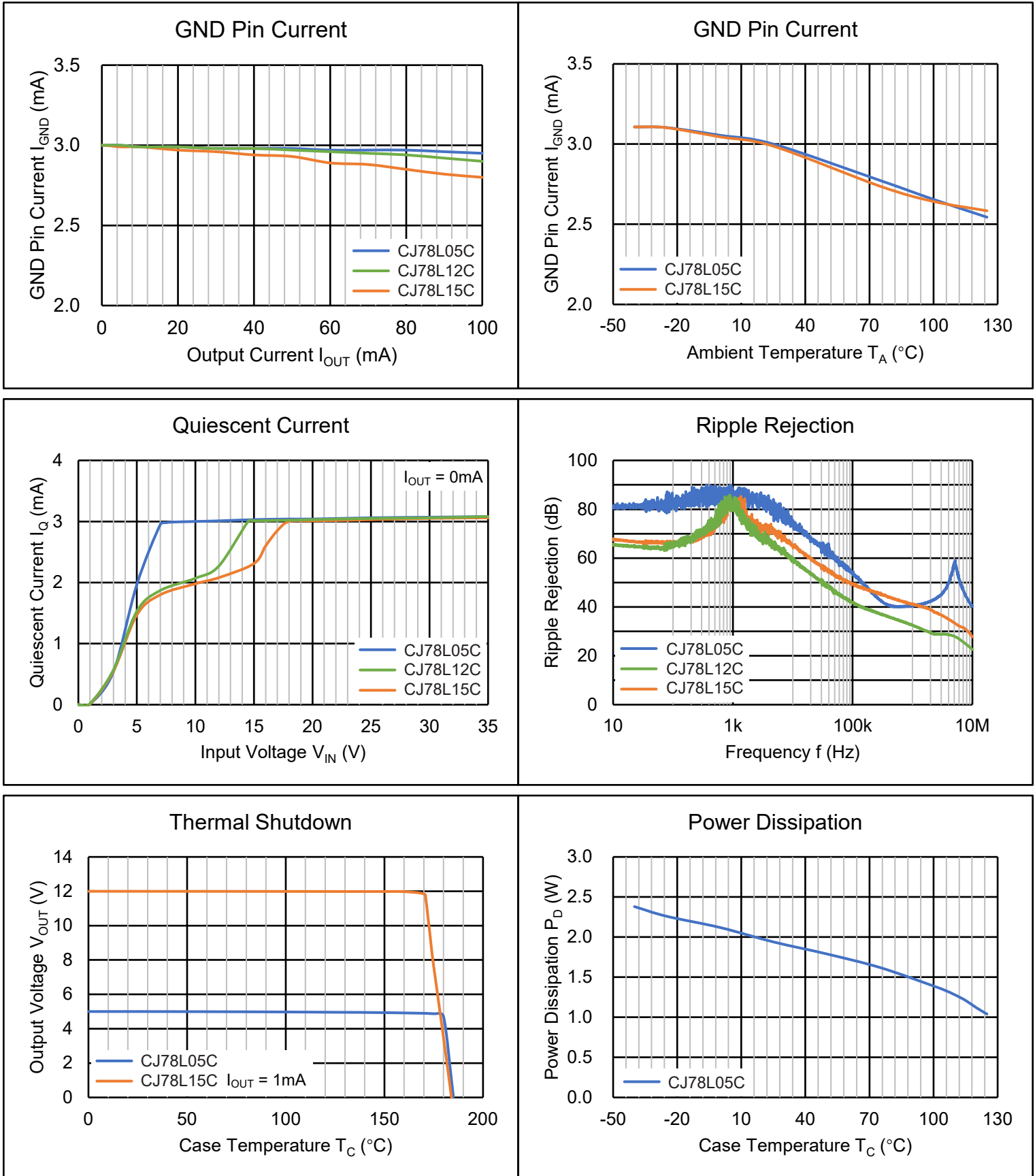

7 Specifications

7.6 Typical Characteristics (continued)

CJ78L00C Series ($C_{IN} = 0.33\mu\text{F}$, $C_{OUT} = 0.1\mu\text{F}$, $T_A = 25^\circ\text{C}$, unless otherwise specified)

Load Transient

CJ78L05C, $V_{IN} = 10\text{V}$, CH2: V_{OUT} , CH4: I_{OUT}

$I_{OUT}: 0 \sim 100\text{mA}$

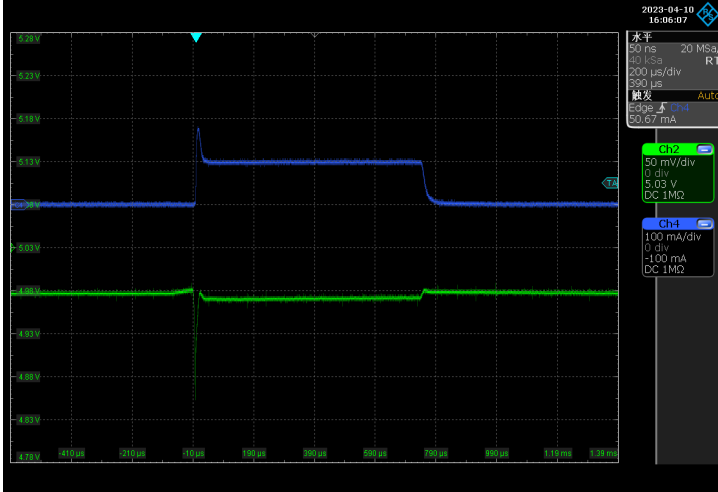

$I_{OUT}: 0 \sim 40\text{mA}$

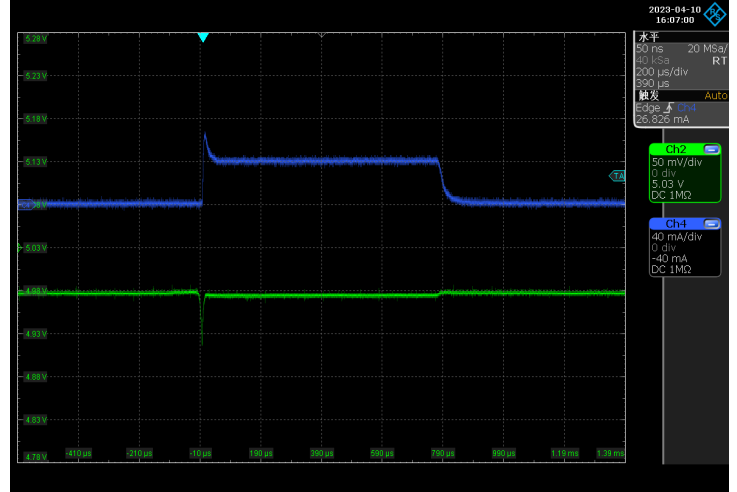

$I_{OUT}: 10 \sim 40\text{mA}$

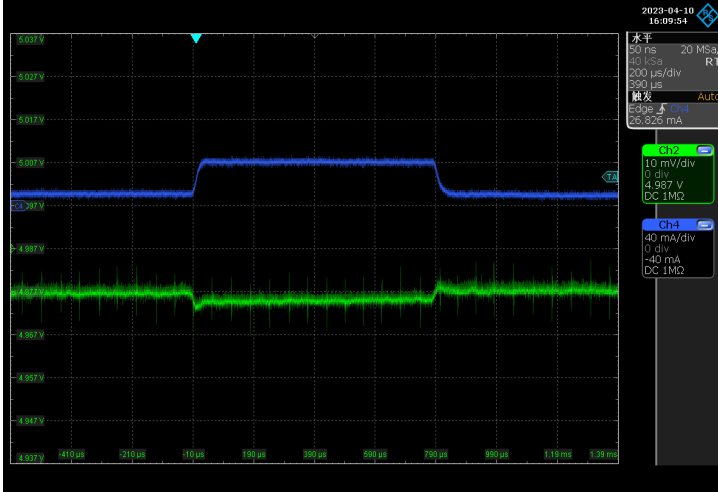

$I_{OUT}: 10 \sim 80\text{mA}$

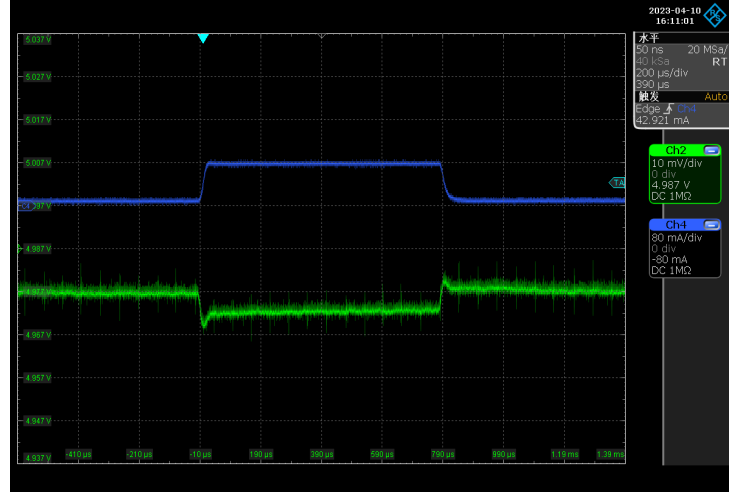

CJ78L12C, $V_{IN} = 14.5\text{V}$, CH2: V_{OUT} , CH4: I_{OUT}

$I_{OUT}: 0 \sim 100\text{mA}$

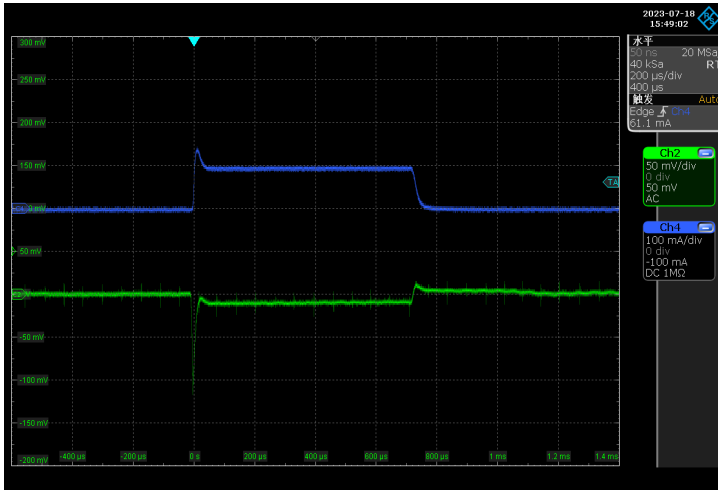

$I_{OUT}: 0 \sim 40\text{mA}$

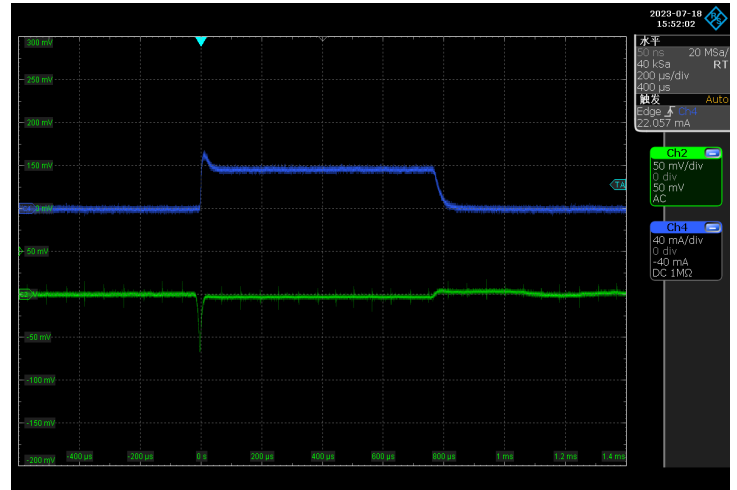

7 Specifications

7.6 Typical Characteristics (continued)

CJ78L00C Series ($C_{IN} = 0.33\mu\text{F}$, $C_{OUT} = 0.1\mu\text{F}$, $T_A = 25^\circ\text{C}$, unless otherwise specified)

Load Transient (continued)

CJ78L12C, $V_{IN} = 14.5\text{V}$, CH2: V_{OUT} , CH4: I_{OUT}

$I_{OUT}: 10 \sim 40\text{mA}$

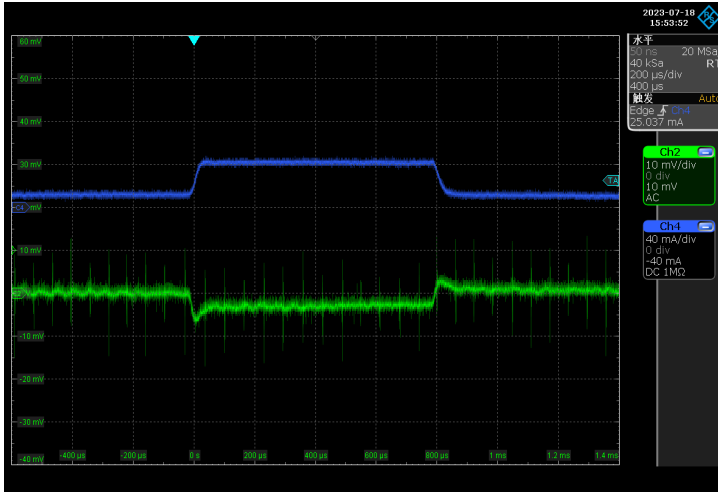

$I_{OUT}: 10 \sim 80\text{mA}$

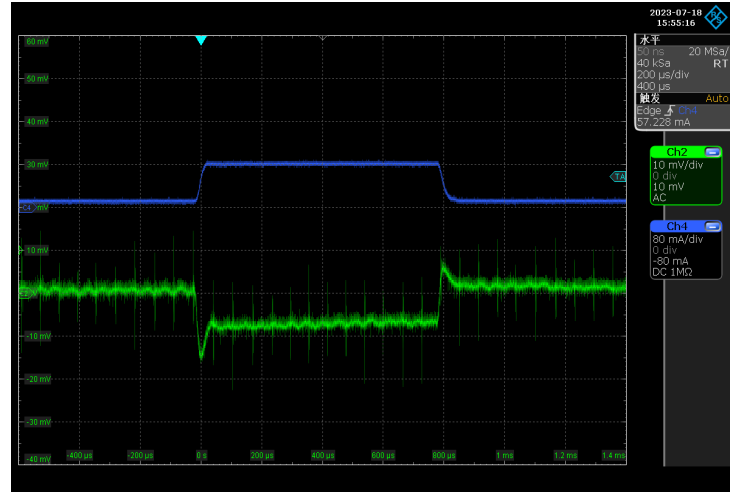

CJ78L15C, $V_{IN} = 23\text{V}$, CH2: V_{OUT} , CH4: I_{OUT}

$I_{OUT}: 0 \sim 100\text{mA}$

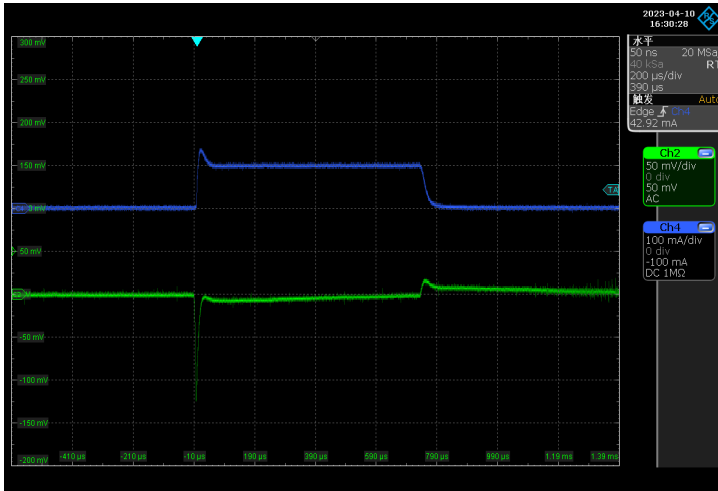

$I_{OUT}: 0 \sim 40\text{mA}$

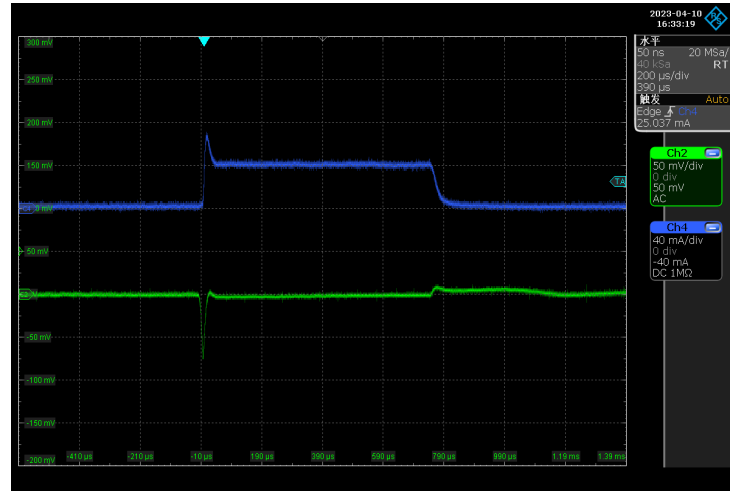

$I_{OUT}: 10 \sim 40\text{mA}$

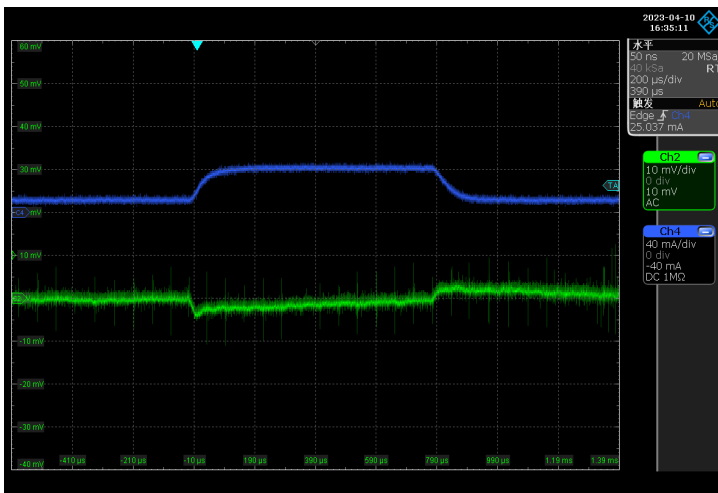

$I_{OUT}: 10 \sim 80\text{mA}$

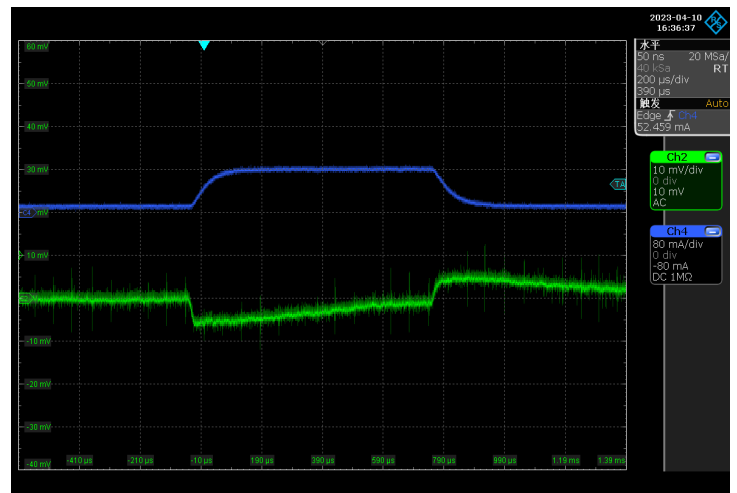

7 Specifications

7.6 Typical Characteristics (continued)

CJ78L00C Series ($C_{IN} = 0.33\mu\text{F}$, $C_{OUT} = 0.1\mu\text{F}$, $T_A = 25^\circ\text{C}$, unless otherwise specified)

Power-up Response

CJ78L05C, $V_{IN} = 0 \sim 10\text{V}$, CH1: V_{IN} , CH2: V_{OUT}

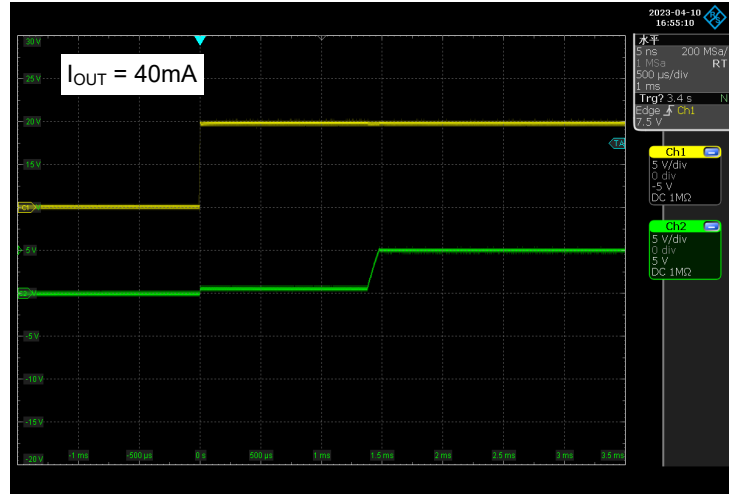
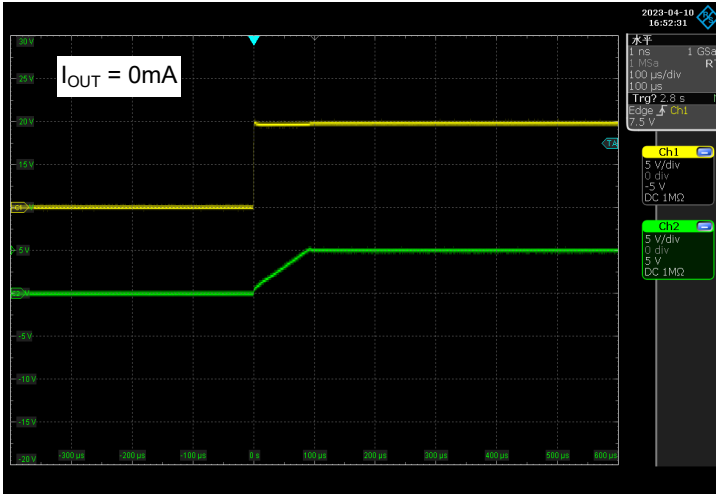

CJ78L12C, $V_{IN} = 0 \sim 14.5\text{V}$, CH1: V_{IN} , CH2: V_{OUT}

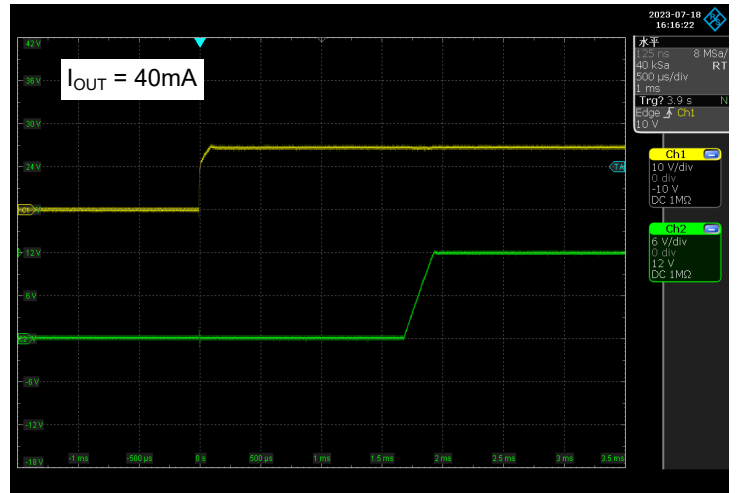
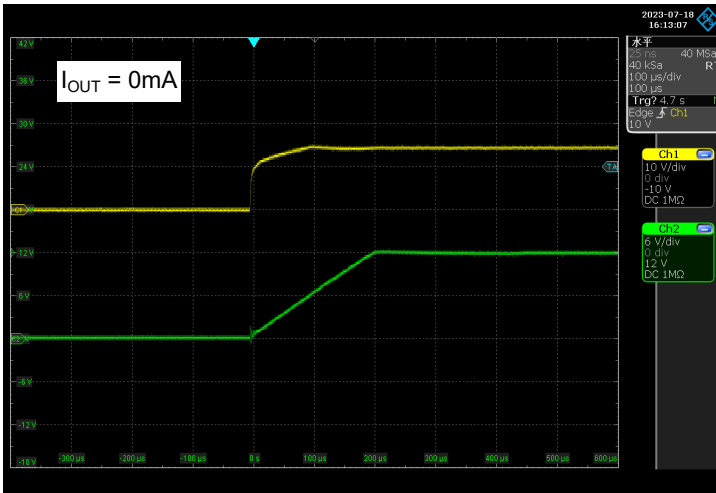

CJ78L15C, $V_{IN} = 0 \sim 23\text{V}$, CH1: V_{IN} , CH2: V_{OUT}

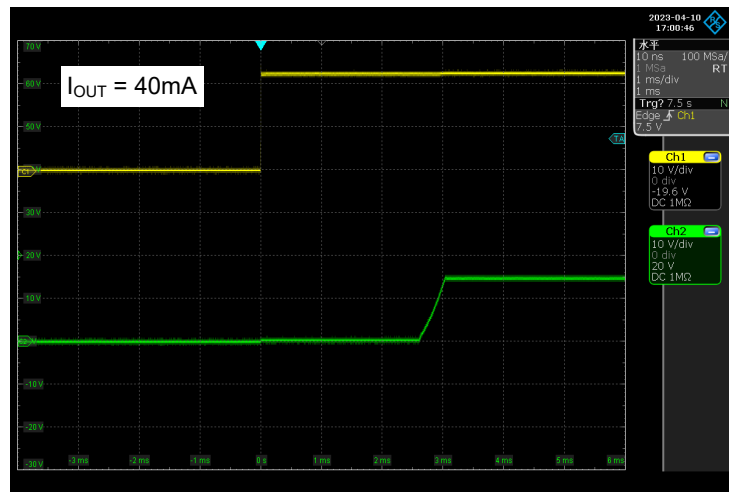
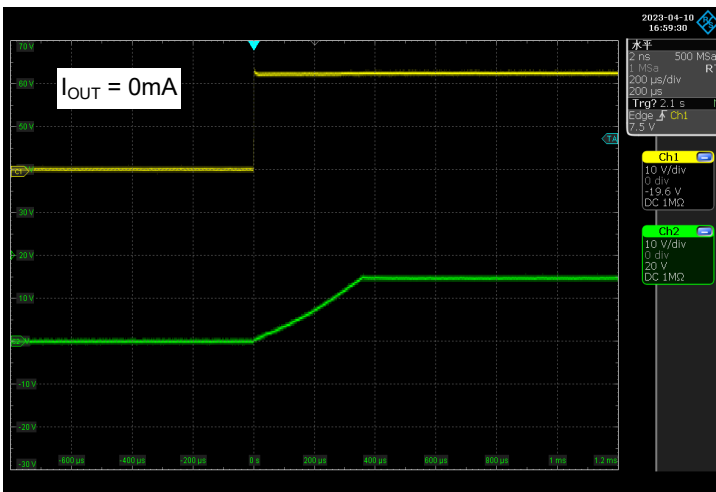

8 Detailed Description

8.1 Description

As a positive voltage linear regulator with a fixed output voltage, the CJ78L00C series is designed for a wide range of application conditions. It integrates current limiting, thermal shutdown, and output transistor SOA protection mechanisms to ensure that it is basically unaffected by output overload. By adding and setting two bypass resistors, the fixed output CJ78L00C series can be used as a voltage adjustable output circuit.

8.2 Representative Schematic Diagram

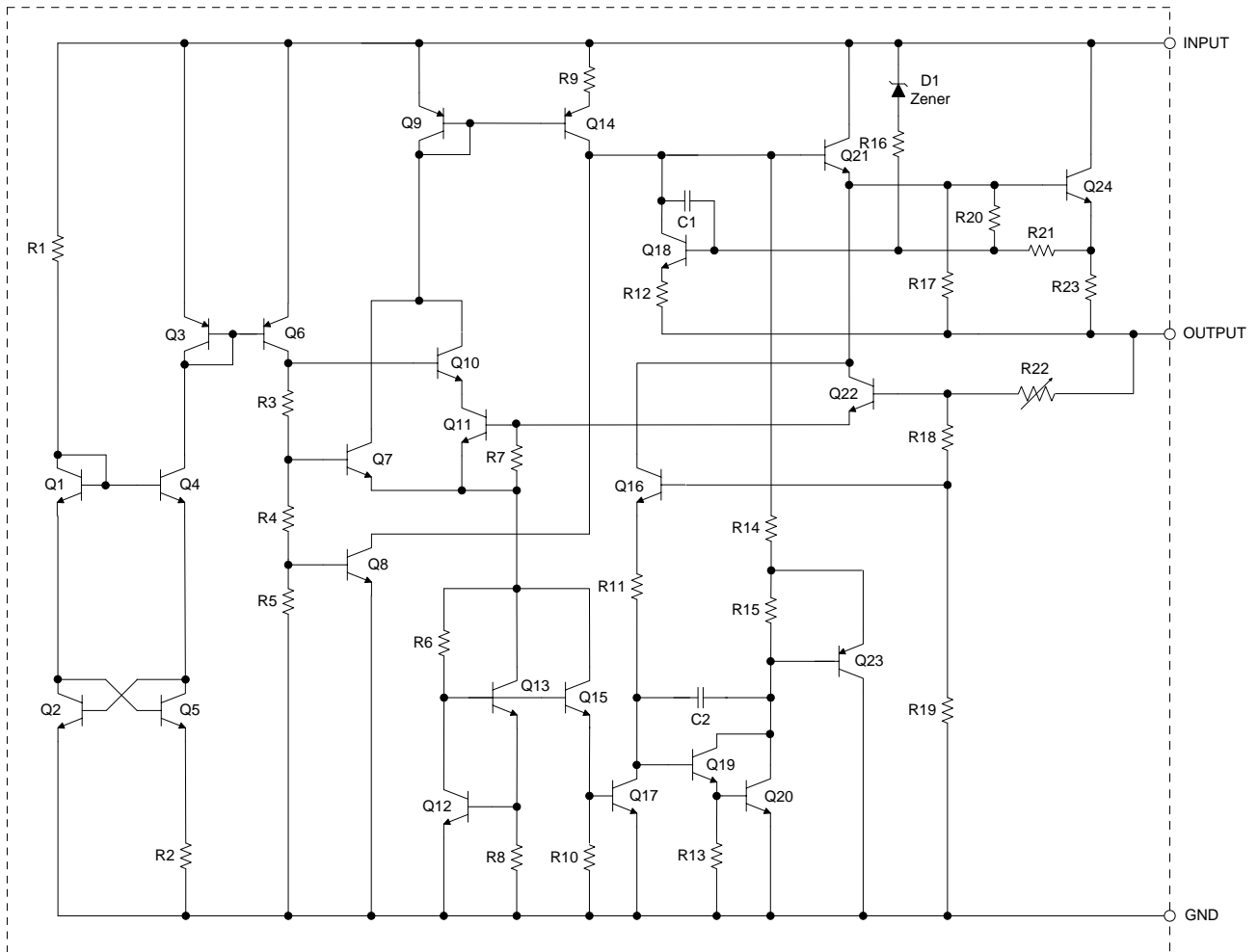

8 Detailed Description

8.3 Feature Description

Power Input

When the input voltage is lower than the rated range of the data sheet, the device will lose the regulation function of stabilizing the output voltage, that is, it is unable to maintain the output voltage within the rated range. At this time, compared with normal operation, the quiescent current of the device may exceed the rated range, and the transient response performance of the device may be seriously degraded.

When the input voltage is higher than the rated range of the data sheet, the device may cause irreversible damage or failure due to exceeding the maximum rated range of electrical stress.

Output Current

When the circuit design is appropriate, the CJ78L00C series can reach the maximum load capacity of at least 100mA. According to the heat dissipation power consumption of the package and the effective connection thermal resistance with the environment, selecting the appropriate package for the circuit design can make the device emit more heat energy.

Thermal Shutdown

The CJ78L00C series has thermal shutdown protection mechanism. When the junction temperature exceeds the rated temperature range for normal operation in the data sheet, the device will enter the thermal shutdown state. At this time, the output voltage of the device will be reduced to prevent catastrophic damage to the chip due to accidental heat. When the junction temperature decreases and no longer remains too high, the device will release the thermal shutdown and output normally.

To ensure reliable operation, please limit the junction temperature to the specified range of recommended operating conditions in the data sheet. Applications that exceed the recommended temperature range may cause the device to exceed its operating specifications. Although the internal protection circuitry of the device is designed to protect against thermal overall conditions, this circuitry is not intended to replace proper heat sinking. Continuously running the device into thermal shutdown or above the maximum recommended junction temperature reduces long-term reliability.

Current Limit & Short Circuit Protection

The CJ78L00C series has current limiting and short circuit protection mechanism. When the output current of the device is too high, the output of the device will be shut down. When the output of the device is short circuited to ground, the output of the device will also be shut down and the output current will be maintained within a certain range.

9 Application and Implementation

9.1 Risk Alert and Precautions

The CJ78L00C series is designed for thermal protection, output SOA protection and built-in current limit. However, like any IC regulator, precautions are necessary to reduce the possibility of accidental damage to the regulator. The following describes the possible causes of unit damage or failure:

Electrostatic Discharge (ESD) and Instantaneous Electrical Surge

Electrostatic discharge (ESD) is a common near-field hazard source. It comes from many sources, such as human body, mechanical equipment and electronic components themselves. ESD can cause phenomena such as high voltage and instantaneous high current in a very short time, resulting in damage or failure of the device due to electric shock.

In some applications, a short duration but high energy spike may occur in the circuit, including peak voltage and surge current. They may cause unstable operation of the regulator, accelerated aging and potential hazards, and even damage or malfunction of the regulator. These peaks are usually more likely to occur in hot-plug, switch inductance, heavy-load, and other types of circuits.

Precautions for ESD and Electrical Surge

In the practical application of the circuit, adopting the following suggestions can reduce the possibility of device failure due to the above reasons to a certain extent.

1. Place a TVS between the IN and GND of the voltage regulator to absorb the peak voltage that may be generated due to ESD or other reasons. As shown in Figure 9-2;
2. Place a resistor with appropriate resistance in series before the IN of the voltage regulator, which can help the voltage regulator share part of the energy in case of surge. The resistance value of the resistance should not be too large. The specific resistance value depends on the application of the circuit. Generally, the resistance value of this resistance does not exceed 20Ω. As shown in Figure 9-3.
3. For the application circuit using the low ESR multilayer ceramic capacitor (MLCC) type input capacitor, the LC resonant voltage spike caused by hot plugging or power transmission line inductance can be suppressed by using RC suppression circuit for parallel connection of the input capacitor. A very simple method is to parallel a suitable electrolytic capacitor to the input capacitor. As shown in Figure 9-4. For most 100μF/25V electrolytic capacitor has an ESR of about 0.2Ω at 100kHz. This can completely suppress the overshoot phenomenon of the input and minimize the possibility of IC damage due to input voltage spikes.

For the CJ78L00C series, it is recommended that the peak voltage should not exceed 36V. When the input voltage of the operating circuit may not meet the application conditions described above, it is recommended to adopt the circuit layout shown in Figure 9-2 to 9-4 in the circuit design. During the power supply design process, the designer must inspect the application circuit to ensure that under no circumstances will the IC be damaged due to the reasons mentioned above.

Large Output Capacitance

The CJ78L00C series can obtain better transient response with the help of output capacitance. However, if the output capacitor is relatively large, the surge current generated by the charging of the output capacitor will also be large at the moment of power on of the regulator, and the large surge current passing through the regulator may damage the internal circuit. When the output capacitance is large, adopting the circuit design shown in Figure 9-3 will reduce the possibility of damage to the device due to large surge current to a certain extent. It is recommended that the selection of output capacitor should not exceed 20μF. **If the selection of output capacitor exceeds 20μF, it is recommended to adopt the circuit design in Figure 9-3 to reduce the possibility of accidental failure of the device due to large surge current during power on.**

9 Application and Implementation

9.2 Typical Application Circuits

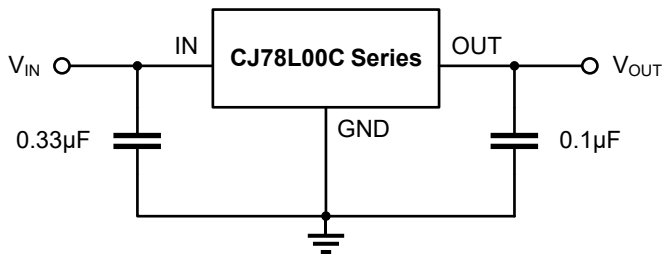

Figure 9-1. Conventional Circuit

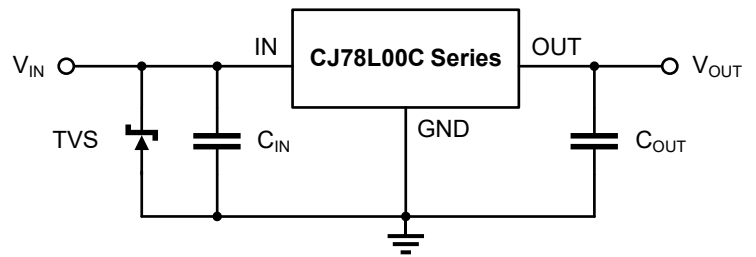

Figure 9-2. TVS is used at IN

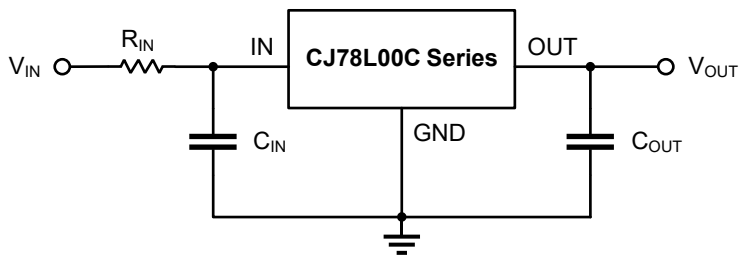

Figure 9-3. Resistance is used at IN

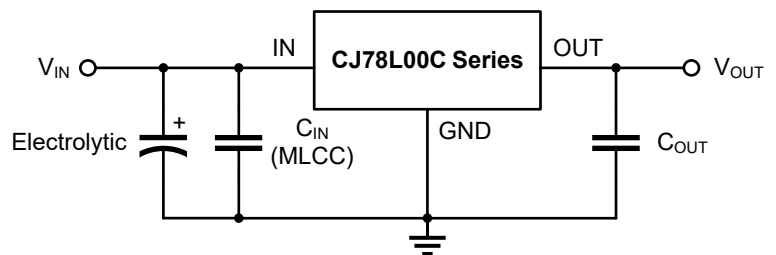

Figure 9-4. Electrolytic capacitor is used at IN

9.3 Bypass Capacitance Selection

A capacitance between IN and GND (C_{IN}) is required if the regulator is located far from the power supply filter. It is recommended to use a $0.33\mu\text{F}$ capacitor for C_{IN} , and the C_{IN} should be placed as close to the device IN pin and GND pin as possible.

It is recommended to use a $0.1\mu\text{F}$ capacitor between OUT and GND (C_{OUT}), and the C_{OUT} should be placed as close as possible between OUT and GND. The output capacitance can limit the high-frequency noise and help the device obtain the best stability and transient response.

The tolerance and temperature coefficient of the C_{IN} and C_{OUT} must be considered to ensure that the capacitor can work normally within the rated working ambient temperature and rated working conditions of the equipment.

It is recommended that the C_{OUT} should not exceed $20\mu\text{F}$. When the C_{OUT} exceeds $20\mu\text{F}$, it is recommended to use the circuit layout shown in Figure 9-2. See *Large Output Capacitance* for more details.

NOTE

The application information in this section is not part of the data sheet component specification, and JSCJ makes no commitment or statement to guarantee its accuracy or completeness. Customers are responsible for determining the rationality of corresponding components in their circuit design and making tests and verifications to ensure the normal realization of their circuit design.

10 Mechanical Information

10.1 SOT-23-3L Mechanical Information

SOT-23-3L Outline Dimensions

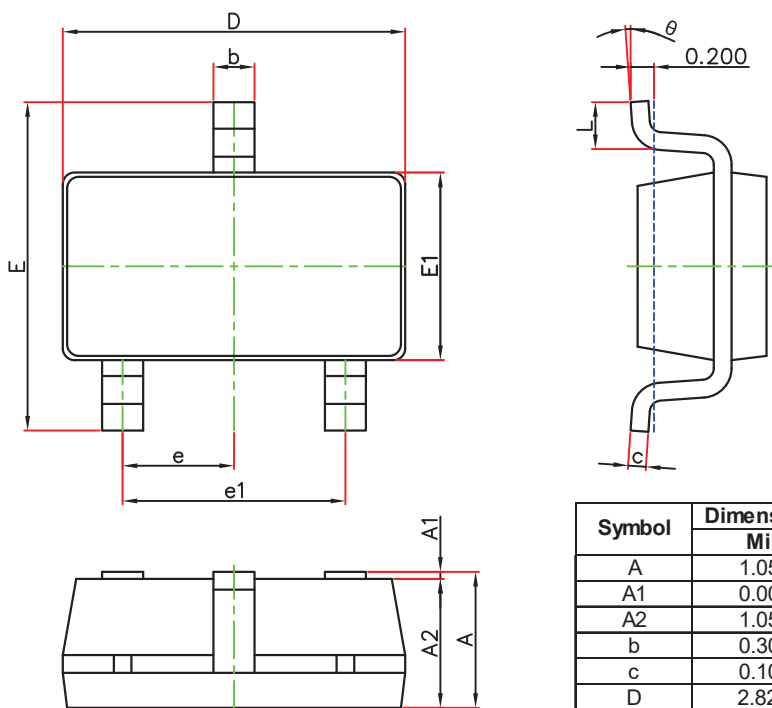

Symbol	Dimensions In Millimeters		Dimensions In Inches	
	Min.	Max.	Min.	Max.
A	1.050	1.250	0.041	0.049
A1	0.000	0.100	0.000	0.004
A2	1.050	1.150	0.041	0.045
b	0.300	0.500	0.012	0.020
c	0.100	0.200	0.004	0.008
D	2.820	3.020	0.111	0.119
E1	1.500	1.700	0.059	0.067
E	2.650	2.950	0.104	0.116
e	0.950(BSC)		0.037(BSC)	
e1	1.800	2.000	0.071	0.079
L	0.300	0.600	0.012	0.024
K	0°	8°	0°	8°

SOT-23-3L Suggested Pad Layout

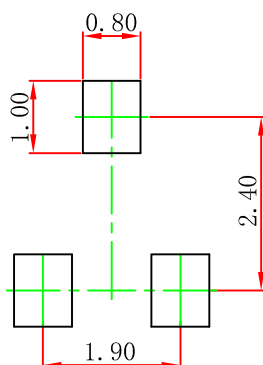

Note:

1. Controlling dimension: in millimeters.
2. General tolerance: $\pm 0.05\text{mm}$.
3. The pad layout is for reference purpose only.

10 Mechanical Information

10.2 SOT-89-3L Mechanical Information

SOT-89-3L Outline Dimensions

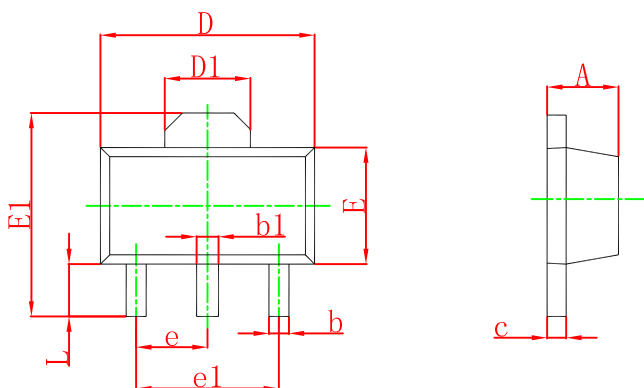

Symbol	Dimensions In Millimeters		Dimensions In Inches	
	Min	Max	Min	Max
A	1.400	1.600	0.055	0.063
b	0.320	0.520	0.013	0.020
b1	0.400	0.580	0.016	0.023
c	0.350	0.440	0.014	0.017
D	4.400	4.600	0.173	0.181
D1	1.550 REF.		0.061 REF.	
E	2.300	2.600	0.091	0.102
E1	3.940	4.250	0.155	0.167
e	1.500 TYP.		0.060 TYP.	
e1	3.000 TYP.		0.118 TYP.	
L	0.900	1.200	0.035	0.047

SOT-89-3L Suggested Pad Layout

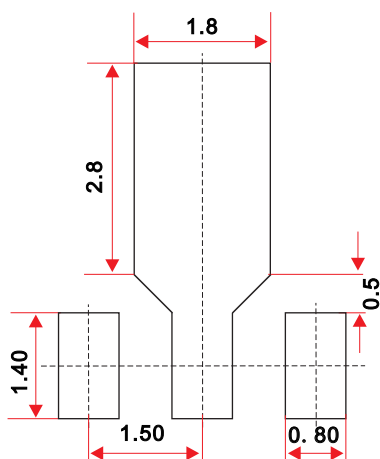

Note:

1. Controlling dimension: in millimeters.
2. General tolerance: $\pm 0.05\text{mm}$.
3. The pad layout is for reference purpose only.

10 Mechanical Information

10.3 TO-92 Mechanical Information

TO-92 Outline Dimensions

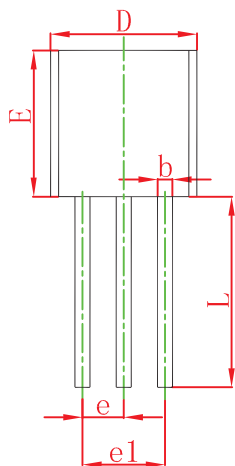
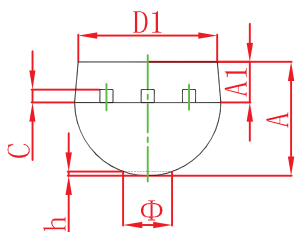

Symbol	Dimensions In Millimeters		Dimensions In Inches	
	Min	Max	Min	Max
A	3.300	3.700	0.130	0.146
A1	1.100	1.400	0.043	0.055
b	0.380	0.550	0.015	0.022
c	0.360	0.510	0.014	0.020
D	4.400	4.700	0.173	0.185
D1	3.430		0.135	
E	4.300	4.700	0.169	0.185
e	1.270 TYP		0.050 TYP	
e1	2.440	2.640	0.096	0.104
L	14.100	14.500	0.555	0.571
K		1.600		0.063
h	0.000	0.380	0.000	0.015

TO-92 Suggested Pad Layout

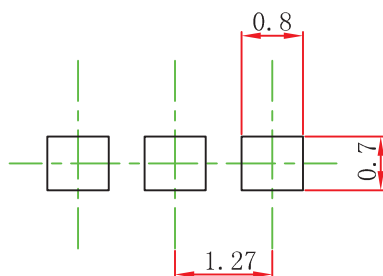

Note:

1. Controlling dimension: in millimeters.
2. General tolerance: $\pm 0.05\text{mm}$.
3. The pad layout is for reference purpose only.

11 Package Information

11.1 SOT-23-3L Tape and Reel Information

Embossed Carrier Tape

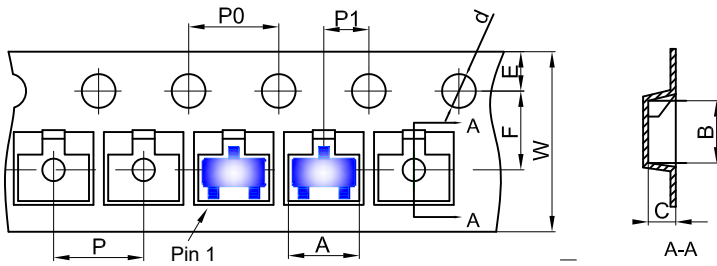

Packaging Description:

SOT-23-3L parts are shipped in tape. The carrier tape is made from a dissipative (carbon filled) polycarbonate resin. The cover tape is a multilayer film (Heat Activated Adhesive in nature) primarily composed of polyester film, adhesive layer, sealant, and anti-static sprayed agent. These reeled parts in standard option are shipped with 3,000 units per 7" or 18.0cm diameter reel. The reels are clear in color and is made of polystyrene plastic (anti-static coated).

Dimensions are in millimeter										
Pkg type	A	B	C	d	E	F	P0	P	P1	W
SOT-23-3L	3.18	3.28	1.32	Ø1.50	1.75	3.50	4.00	4.00	2.00	8.00

SOT-23-3L Tape Leader and Trailer

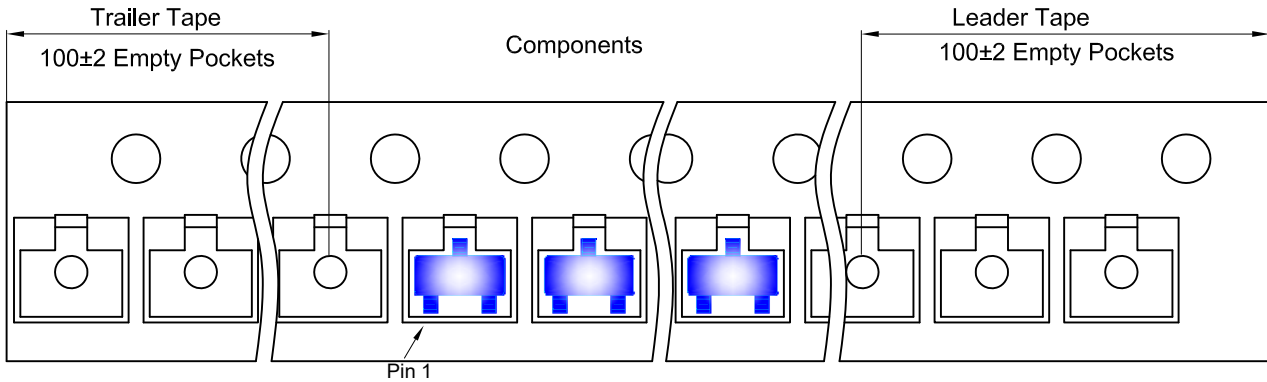

SOT-23-3L Reel

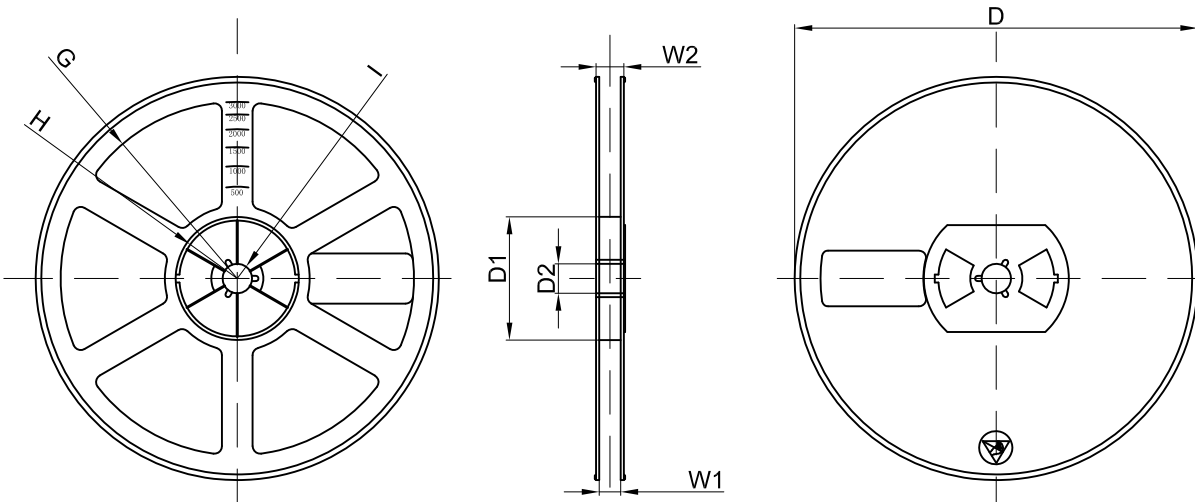

Dimensions are in millimeter								
Reel Option	D	D1	D2	G	H	I	W1	W2
7" Dia	Ø180.00	60.00	13.00	R78.00	R25.60	R6.50	9.50	13.10

REEL	Reel Size	Box	Box Size(mm)	Carton	Carton Size(mm)	G.W.(kg)
3000 pcs	7 inch	30,000 pcs	203×203×195	120,000 pcs	438×438×220	

11 Package Information

11.2 SOT-89-3L Tape and Reel Information

Embossed Carrier Tape

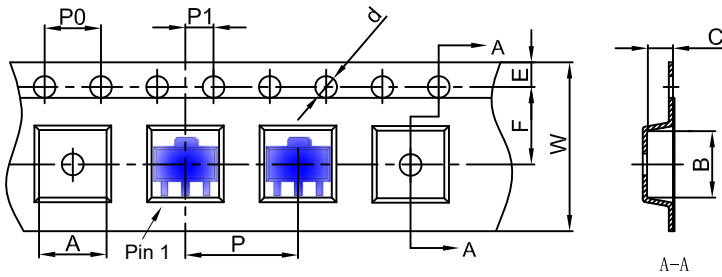

Packaging Description:
 SOT-89-3L parts are shipped in tape. The carrier tape is made from a dissipative (carbon filled) polycarbonate resin. The cover tape is a multilayer film (Heat Activated Adhesive in nature) primarily composed of polyester film, adhesive layer, sealant, and anti-static sprayed agent. These reeled parts in standard option are shipped with 1,000 units per 7" or 18.0 cm diameter reel. The reels are clear in color and is made of polystyrene plastic (anti-static coated).

Dimensions are in millimeter										
Pkg type	A	B	C	d	E	F	P0	P	P1	W
SOT-89-3L	4.85	4.45	1.85	Ø1.50	1.75	5.50	4.00	8.00	2.00	12.00

SOT-89-3L Tape Leader and Trailer

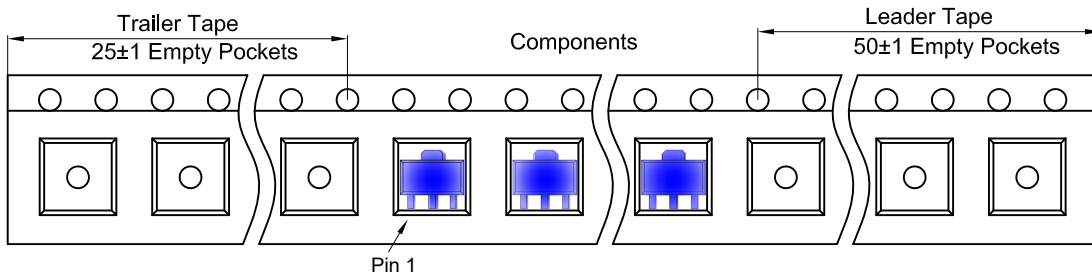

SOT-89-3L Reel

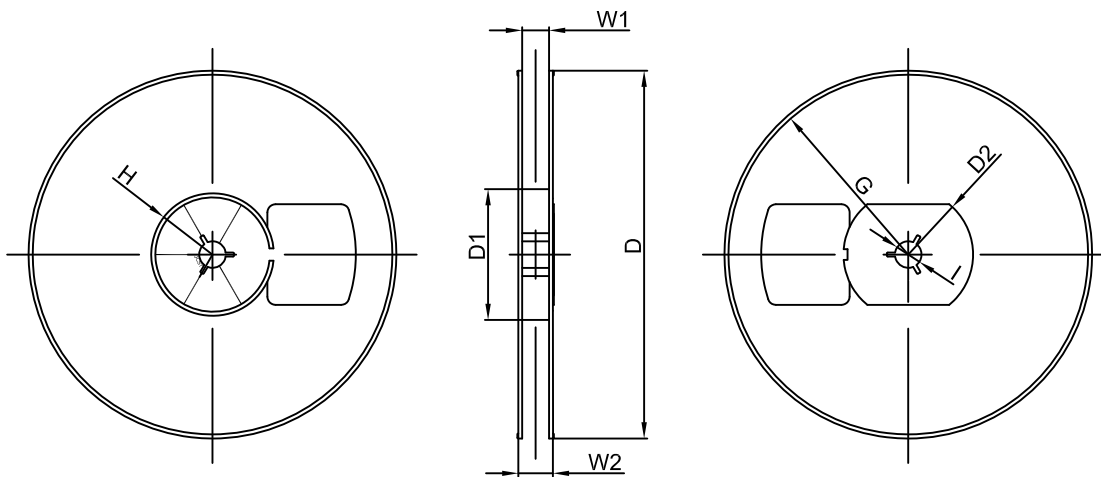

Dimensions are in millimeter								
Reel Option	D	D1	D2	G	H	I	W1	W2
7"Dia	Ø180.00	60.00	R32.00	R86.50	R30.00	Ø13.00	13.20	16.50

REEL	Reel Size	Box	Box Size(mm)	Carton	Carton Size(mm)	G.W.(kg)
1000 pcs	7 inch	10,000 pcs	203×203×195	40,000 pcs	438×438×220	

11 Package Information

11.3 TO-92 Tape and Reel Information

Embossed Carrier Tape

Note: For CJ78L05C-TA, CJ78L12C-TA and CJ78L15C-TA

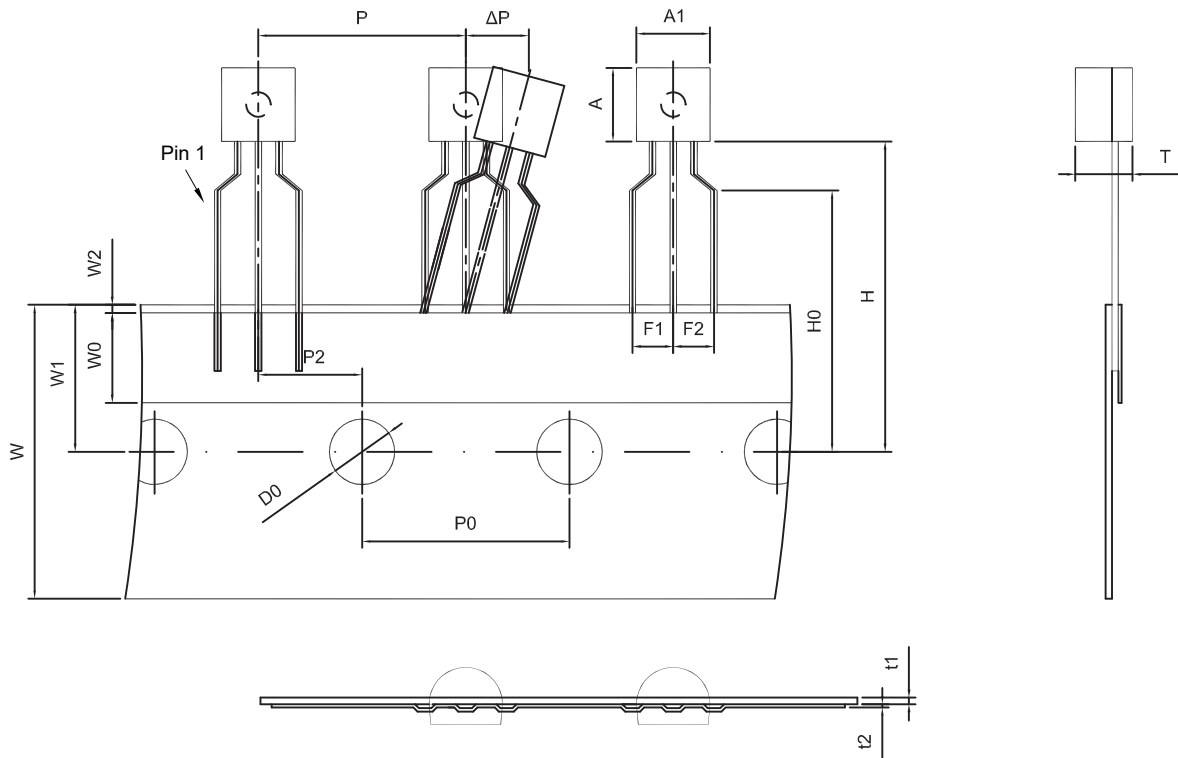

Dimensions are in millimeter								
A1	A	T	P	P0	P2	F1	F2	W
4.5	4.5	3.5	12.7	12.7	6.35	2.5	2.5	18.0
W0	W1	W2	H	H0	D0	t1	t2	ΔP
6.0	9.0	1.0 MAX.	19.0	16.0	4.0	0.4	0.2	0

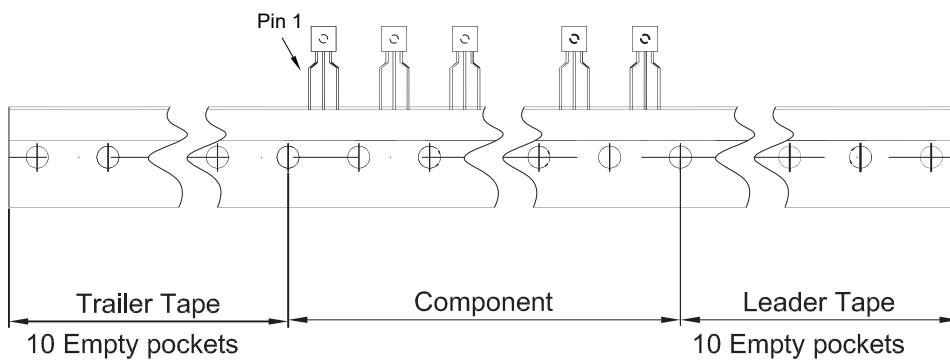

Package	Box	Box Size(mm)	Carton	Carton Size(mm)
TO-92	2000 pcs	333×162×43	20,000 pcs	350×340×250

12 Notes and Revision History

12.1 Associated Product Family and Others

To view other products of the same type or IC products of other types, please click the official website of JSCJ -- [https: www.jscj-elec.com](https://www.jscj-elec.com) for more details.

12.2 Notes

Electrostatic Discharge Caution



This IC may be damaged by ESD. Relevant personnel shall comply with correct installation and use specifications to avoid ESD damage to the IC. If appropriate measures are not taken to prevent ESD damage, the hazards caused by ESD include but are not limited to degradation of integrated circuit performance or complete damage of integrated circuit. For some precision integrated circuits, a very small parameter change may cause the whole device to be inconsistent with its published specifications.

12.3 Revision History

July, 2023: changed from rev -1.1 to rev - 1.2:

- Page 18, Typical Characteristics, added the description of the CJ78L12C device.

May, 2023: changed from rev - 1.0 to 1.1:

- Added new device: CJ78L06C, CJ78L08C, CJ78L09C and CJ78L18C;
- Orderable Information, adopted new product naming conventions;
- Page 4, Pin Configuration and Function, changed to a more detailed packaging diagram
- Page 5, Recommend Operation Conditions, removed notes on recommended working conditions;
- Page 24, Notes, removed notes on thermal metric.

April, 2023: released CJ78L00C series rev - 1.0.

DISCLAIMER

IMPORTANT NOTICE, PLEASE READ CAREFULLY

The information in this data sheet is intended to describe the operation and characteristics of our products. JSCJ has the right to make any modification, enhancement, improvement, correction or other changes to any content in this data sheet, including but not limited to specification parameters, circuit design and application information, without prior notice.

Any person who purchases or uses JSCJ products for design shall: 1. Select products suitable for circuit application and design; 2. Design, verify and test the rationality of circuit design; 3. Procedures to ensure that the design complies with relevant laws and regulations and the requirements of such laws and regulations. JSCJ makes no warranty or representation as to the accuracy or completeness of the information contained in this data sheet and assumes no responsibility for the application or use of any of the products described in this data sheet.

Without the written consent of JSCJ, this product shall not be used in occasions requiring high quality or high reliability, including but not limited to the following occasions: medical equipment, military facilities and aerospace. JSCJ shall not be responsible for casualties or property losses caused by abnormal use or application of this product.

Official Website: www.jscj-elec.com

Copyright © JIANGSU CHANGJING ELECTRONICS TECHNOLOGY CO., LTD.