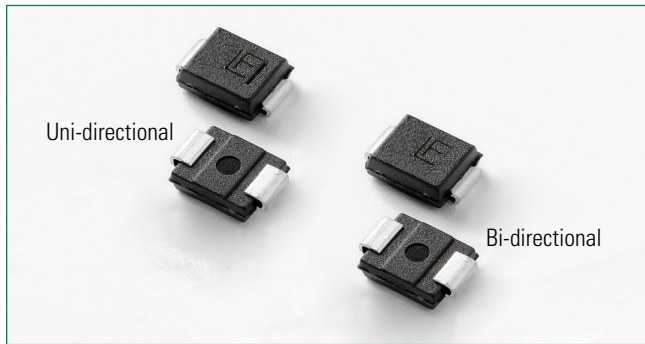


**P6SMB Series**



**Agency Approvals**

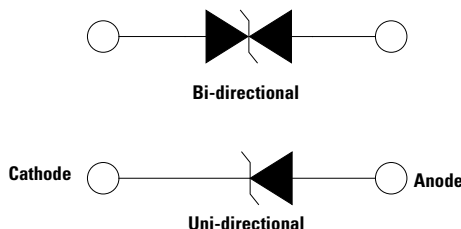
Agency	Agency File Number
	E230531

**Maximum Ratings and Thermal Characteristics**  
(T<sub>A</sub> = 25°C unless otherwise noted)

Parameter	Symbol	Value	Unit
Peak Pulse Power Dissipation <sup>(Fig.2)</sup> by 10/1000us Test Waveform <sup>(Fig.4)</sup> (Note 1),(Note 2)-Single Die Parts	P <sub>PPM</sub>	600	W
Peak Pulse Power Dissipation <sup>(Fig.2)</sup> by 10/1000us Test Waveform <sup>(Fig.4)</sup> (Note 1, Note 2)-Stacked Die Parts (Note 5)	P <sub>PPM</sub>	800	W
Power Dissipation on Infinite Heat Sink at T <sub>L</sub> =50°C	P <sub>D</sub>	5.0	W
Peak Forward Surge Current, 8.3ms Single Half Sine Wave (Note 3)	I <sub>FSM</sub>	100	A
Maximum Instantaneous Forward Voltage at 50A for Unidirectional Only (Note 4)	V <sub>F</sub>	3.5/5.0	V
Operating Temperature Range	T <sub>J</sub>	-65 to 150	°C
Storage Temperature Range	T <sub>STG</sub>	-65 to 175	°C
Typical Thermal Resistance Junction to Lead	R <sub>θJL</sub>	20	°C/W
Typical Thermal Resistance Junction to Ambient	R <sub>θJA</sub>	100	°C/W

- Notes:**
1. Non-repetitive current pulse, per Fig. 4 and derated above T<sub>J</sub> (initial) = 25°C per Fig. 3.
  2. Mounted on copper pad area of 0.2x0.2" (5.0 x 5.0mm) to each terminal.
  3. Measured on 8.3ms single half sine wave or equivalent square wave for unidirectional device only, duty cycle=4 per minute maximum.
  4. V<sub>F</sub> < 3.5V for single die parts and V<sub>F</sub> < 5.0V for stacked-die parts.
  5. For stacked die component details, please refer to part numbers labeled by \* in Electrical Characteristics.

**Functional Diagram**



**Description**

The P6SMB series is designed specifically to protect sensitive electronic equipment from voltage transients induced by lightning and other transient voltage events.

**Features**

- 600W peak pulse power capability at 10/1000µs waveform, repetition rate (duty cycles):0.01 %
- Excellent clamping capability
- Low incremental surge resistance
- Typical I<sub>R</sub> less than 1µA when V<sub>BR</sub> min > 12V
- Optimized surface mount footprint for minimal PCB space impact
- Low profile package
- Typical failure mode due to exceeding maximum ratings is a short circuit condition
- Whisker test conducted based on Table 4a and 4c of JEDEC JESD201A
- IEC 61000-4-2 ESD 30kV(Air), 30kV (Contact)
- EFT protection of data lines in accordance with IEC 61000-4-4
- Built-in strain relief
- Fast response time: typically less than 1.0ps from 0V to V<sub>BR</sub> min
- High temperature to reflow soldering guaranteed: 260°C/30sec
- V<sub>BR</sub> @ T<sub>J</sub> = V<sub>BR</sub> @ 25°C x (1 + α T x (T<sub>J</sub> - 25)) (α T: Temperature Coefficient, typical value is 0.1%)
- UL Recognized compound meeting flammability classification V-0
- Meet MSL level1, per J-STD-020, LF maximum peak of 260°C
- Matte tin lead-free plated
- Halogen free and RoHS compliant
- Pb-free E3 means 2<sup>ND</sup> level interconnect is Pb-free and the terminal finish material is tin(Sn) (IPC/ JEDEC J-STD-609A.01)
- UL Recognized to ANSI/UL 497B: Protectors for Data Communications and Fire-Alarm Circuits.


**Applications**

TVS devices are ideal for the protection of I/O Interfaces, V<sub>CC</sub> bus and other vulnerable circuits used in Telecom, Computer, Industrial and Consumer electronic applications.

**Additional Information**

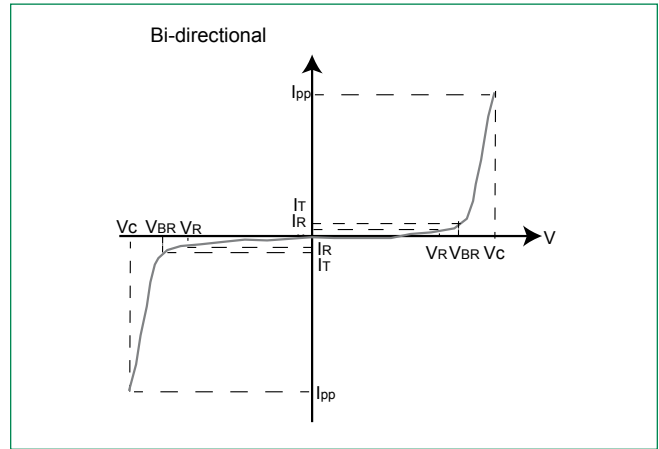
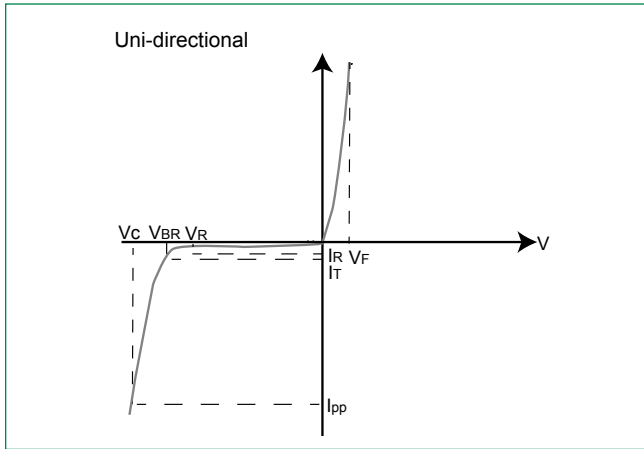


### Electrical Characteristics (T<sub>A</sub>=25°C unless otherwise noted)

Part Number (Uni)	Part Number (Bi)	Marking		Reverse Stand off Voltage V <sub>R</sub> (Volts)	Breakdown Voltage V <sub>BR</sub> (Volts) @ I <sub>T</sub>		Test Current I <sub>T</sub> (mA)	Maximum Clamping Voltage V <sub>C</sub> @ I <sub>pp</sub> (V)	Maximum Peak Pulse Current I <sub>pp</sub> (A)	Maximum Reverse Leakage I <sub>R</sub> @ V <sub>R</sub> (µA)	Maximum Temperature coefficient of V <sub>BR</sub> (%/°C)	Agency Approval 
		UNI	BI		MIN	MAX						
P6SMB6.8A	P6SMB6.8CA	6V8A	6V8C	5.80	6.45	7.14	10	10.5	58.1	1000	0.041	X
P6SMB7.5A	P6SMB7.5CA	7V5A	7V5C	6.40	7.13	7.88	10	11.3	54.0	500	0.054	X
P6SMB8.2A	P6SMB8.2CA	8V2A	8V2C	7.02	7.79	8.61	10	12.1	50.4	200	0.058	X
P6SMB9.1A	P6SMB9.1CA	9V1A	9V1C	7.78	8.65	9.55	1	13.4	45.5	50	0.063	X
P6SMB10A	P6SMB10CA	10A	10C	8.55	9.50	10.50	1	14.5	42.1	10	0.066	X
P6SMB11A	P6SMB11CA	11A	11C	9.40	10.50	11.60	1	15.6	39.1	5	0.069	X
P6SMB12A	P6SMB12CA	12A	12C	10.20	11.40	12.60	1	16.7	36.5	5	0.071	X
P6SMB13A	P6SMB13CA	13A	13C	11.10	12.40	13.70	1	18.2	33.5	1	0.074	X
P6SMB15A	P6SMB15CA	15A	15C	12.80	14.30	15.80	1	21.2	28.8	1	0.076	X
P6SMB16A	P6SMB16CA	16A	16C	13.60	15.20	16.80	1	22.5	27.1	1	0.080	X
P6SMB18A	P6SMB18CA	18A	18C	15.30	17.10	18.90	1	25.5	24.2	1	0.083	X
P6SMB20A	P6SMB20CA	20A	20C	17.10	19.00	21.00	1	27.7	22.0	1	0.085	X
P6SMB22A	P6SMB22CA	22A	22C	18.80	20.90	23.10	1	30.6	19.9	1	0.088	X
P6SMB24A	P6SMB24CA	24A	24C	20.50	22.80	25.20	1	33.2	18.4	1	0.091	X
P6SMB27A	P6SMB27CA	27A	27C	23.10	25.70	28.40	1	37.5	16.3	1	0.092	X
P6SMB30A	P6SMB30CA	30A	30C	25.60	28.50	31.50	1	41.4	14.7	1	0.093	X
P6SMB33A	P6SMB33CA	33A	33C	28.20	31.40	34.70	1	45.7	13.3	1	0.094	X
P6SMB36A	P6SMB36CA	36A	36C	30.80	34.20	37.80	1	49.9	12.2	1	0.096	X
P6SMB39A	P6SMB39CA	39A	39C	33.30	37.10	41.00	1	53.9	11.3	1	0.097	X
P6SMB43A	P6SMB43CA	43A	43C	36.80	40.90	45.20	1	59.3	10.3	1	0.098	X
P6SMB47A	P6SMB47CA	47A	47C	40.20	44.70	49.40	1	64.8	9.4	1	0.099	X
P6SMB51A	P6SMB51CA	51A	51C	43.60	48.50	53.60	1	70.1	8.7	1	0.100	X
P6SMB56A	P6SMB56CA	56A	56C	47.80	53.20	58.80	1	77.0	7.9	1	0.101	X
P6SMB58A	P6SMB58CA	58A	58C	52.78	55.10	60.90	1	79.8	7.7	1	0.101	-
P6SMB62A	P6SMB62CA	62A	62C	53.00	58.90	65.10	1	85.0	7.2	1	0.102	X
P6SMB68A	P6SMB68CA	68A	68C	58.10	64.60	71.40	1	92.0	6.6	1	0.103	X
P6SMB75A	P6SMB75CA	75A	75C	64.10	71.30	78.80	1	103.0	5.9	1	0.104	X
P6SMB82A	P6SMB82CA	82A	82C	70.10	77.90	86.10	1	113.0	5.4	1	0.105	X
P6SMB91A	P6SMB91CA	91A	91C	77.80	86.50	95.50	1	125.0	4.9	1	0.106	X
P6SMB100A	P6SMB100CA	100A	100C	85.50	95.00	105.00	1	137.0	4.5	1	0.106	X
P6SMB110A	P6SMB110CA	110A	110C	94.00	105.00	116.00	1	152.0	4.0	1	0.107	X
P6SMB120A	P6SMB120CA	120A	120C	102.00	114.00	126.00	1	165.0	3.7	1	0.107	X
P6SMB130A	P6SMB130CA	130A	130C	111.00	124.00	137.00	1	179.0	3.4	1	0.107	X
P6SMB150A	P6SMB150CA	150A	150C	128.00	143.00	158.00	1	207.0	2.9	1	0.108	X
P6SMB160A	P6SMB160CA	160A	160C	136.00	152.00	168.00	1	219.0	2.8	1	0.108	X
P6SMB170A	P6SMB170CA	170A	170C	145.00	162.00	179.00	1	234.0	2.6	1	0.108	X
P6SMB180A	P6SMB180CA	180A	180C	154.00	171.00	189.00	1	246.0	2.5	1	0.108	X
P6SMB200A	P6SMB200CA	200A	200C	171.00	190.00	210.00	1	274.0	2.2	1	0.108	X
P6SMB220A	P6SMB220CA	220A	220C	185.00	209.00	231.00	1	328.0	1.9	1	0.110	X
P6SMB250A	P6SMB250CA	250A	250C	214.00	237.00	263.00	1	344.0	1.8	1	0.110	X
P6SMB300A	P6SMB300CA	300A	300C	256.00	285.00	315.00	1	414.0	1.5	1	0.110	X
P6SMB350A*	P6SMB350CA*	350A	350C	300.00	332.00	368.00	1	482.0	1.7	1	0.112	X
P6SMB400A*	P6SMB400CA*	400A	400C	342.00	380.00	420.00	1	548.0	1.5	1	0.112	X
P6SMB440A*	P6SMB440CA*	440A	440C	376.00	418.00	462.00	1	602.0	1.4	1	0.112	X
P6SMB480A*	P6SMB480CA*	480A	480C	408.00	456.00	504.00	1	658.0	1.3	1	0.112	X
P6SMB510A*	P6SMB510CA*	510A	510C	434.00	485.00	535.00	1	698.0	1.2	1	0.112	X
P6SMB530A*	P6SMB530CA*	530A	530C	451.00	503.50	556.50	1	725.0	1.2	1	0.112	X
P6SMB540A*	P6SMB540CA*	540A	540C	460.00	513.00	567.00	1	740.0	1.1	1	0.112	X
P6SMB550A*	P6SMB550CA*	550A	550C	468.00	522.50	577.50	1	760.0	1.1	1	0.112	X
P6SMB600A*	P6SMB600CA*	600A	600C	512.00	570.00	630.00	1	828.0	1.0	1	0.112	-

For bidirectional type having V<sub>R</sub> of 10 volts and less, the I<sub>R</sub> limit is double.  
 For stack-die parts, use \* to label the part number.

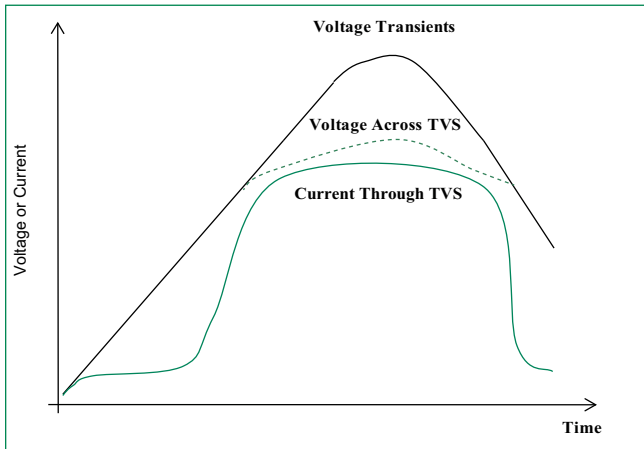
**I-V Curve Characteristics**



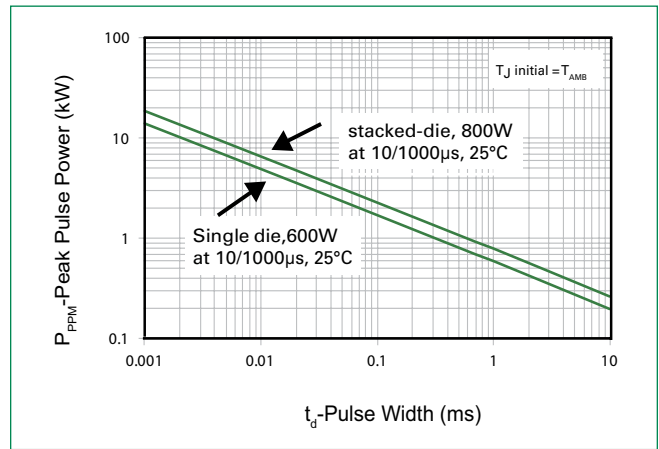
- P<sub>PPM</sub>** Peak Pulse Power Dissipation – Max power dissipation ( $V_C * I_{pp}$ )
- V<sub>R</sub>** Stand-off Voltage – Maximum voltage that can be applied to the TVS without operation
- V<sub>BR</sub>** Breakdown Voltage – Maximum voltage that flows through the TVS at a specified test current ( $I_T$ )
- V<sub>C</sub>** Clamping Voltage – Peak voltage measured across the TVS at a specified  $I_{ppm}$  (peak impulse current)
- I<sub>R</sub>** Reverse Leakage Current – Current measured at  $V_R$
- V<sub>F</sub>** Forward Voltage Drop for Uni-directional

**Ratings and Characteristic Curves** ( $T_A=25^\circ\text{C}$  unless otherwise noted)

**Figure 1 - TVS Transients Clamping Waveform**

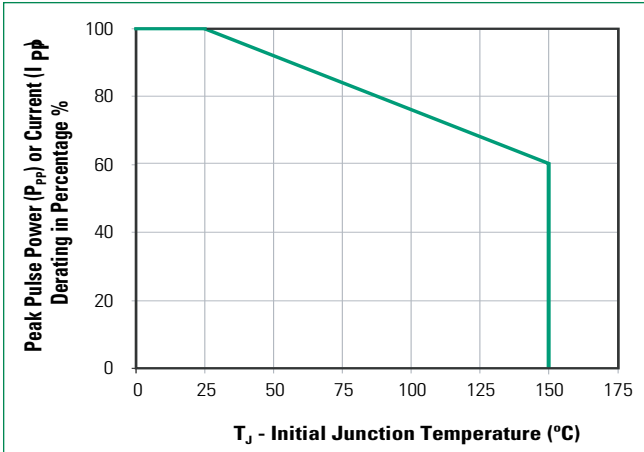


**Figure 2 - Peak Pulse Power Rating**

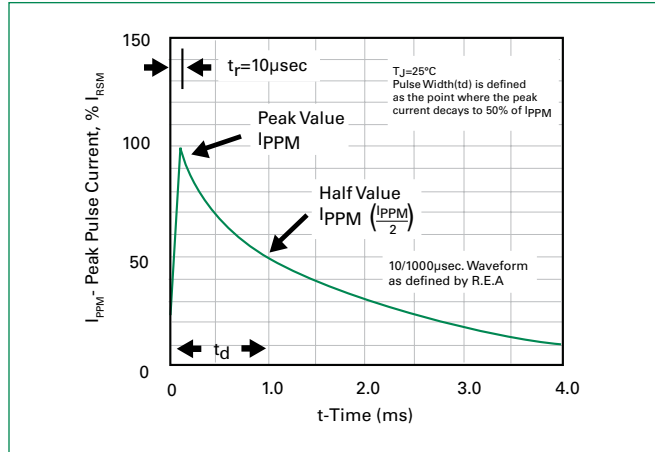


**Ratings and Characteristic Curves** ( $T_A=25^{\circ}\text{C}$  unless otherwise noted) (Continued)

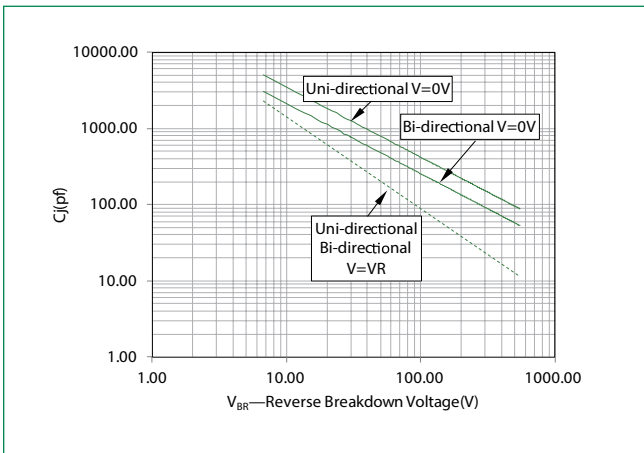
**Figure 3 - Peak Pulse Power Derating Curve**



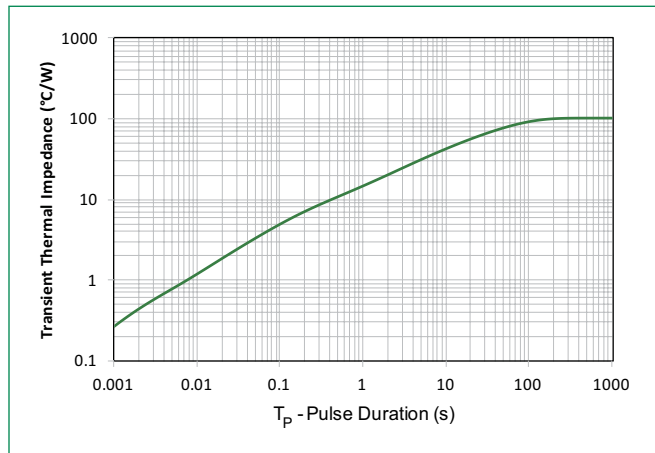
**Figure 4 - Pulse Waveform**



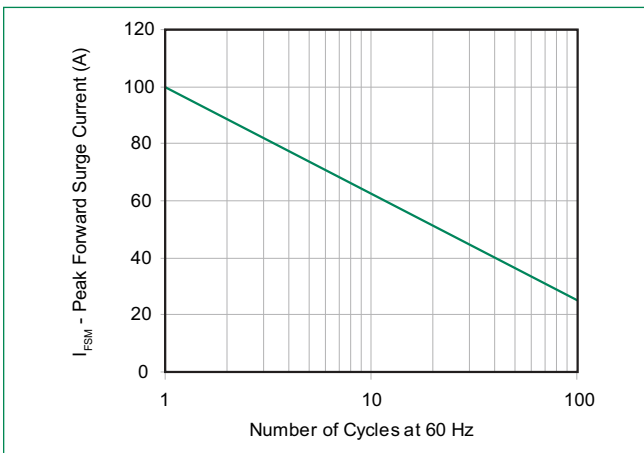
**Figure 5 - Typical Junction Capacitance**



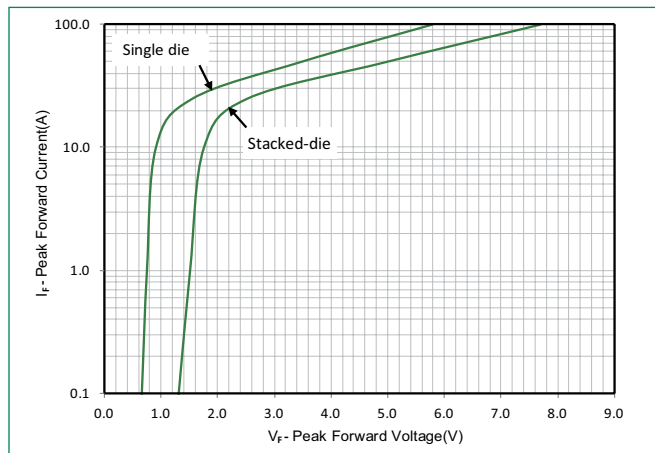
**Figure 6 - Typical Transient Thermal Impedance**



**Figure 7 - Maximum Non-Repetitive Peak Forward Surge Current Uni-Directional Only**

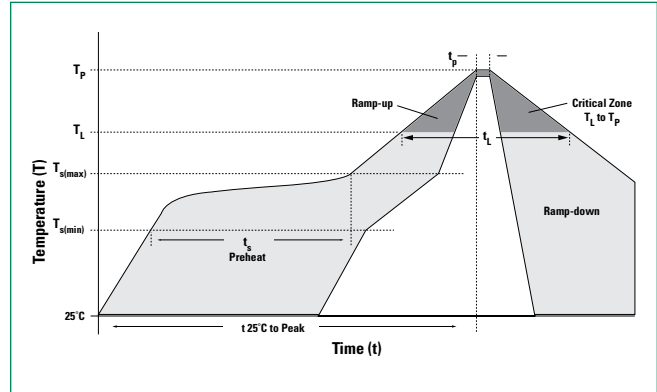


**Figure 8 - Peak Forward Voltage Drop vs Peak Forward Current (Typical Values)**



**Soldering Parameters**

<b>Reflow Condition</b>		Pb-Free assembly
<b>Pre Heat</b>	- Temperature Min ( $T_{s(min)}$ )	150°C
	- Temperature Max ( $T_{s(max)}$ )	200°C
	- Time (min to max) ( $t_s$ )	60 – 120 secs
<b>Average ramp up rate (Liquidus Temp (<math>T_L</math>) to peak)</b>		3°C/second max
<b><math>T_{s(max)}</math> to <math>T_L</math> - Ramp-up Rate</b>		3°C/second max
<b>Reflow</b>	- Temperature ( $T_L$ ) (Liquidus)	217°C
	- Time (min to max) ( $t_L$ )	60 – 150 seconds
<b>Peak Temperature (<math>T_p</math>)</b>		260 <sup>+0/-5</sup> °C
<b>Time within 5°C of actual peak Temperature (<math>t_p</math>)</b>		30 seconds Max
<b>Ramp-down Rate</b>		6°C/second Max
<b>Time 25°C to peak Temperature (<math>T_p</math>)</b>		8 minutes Max.
<b>Do not exceed</b>		260°C



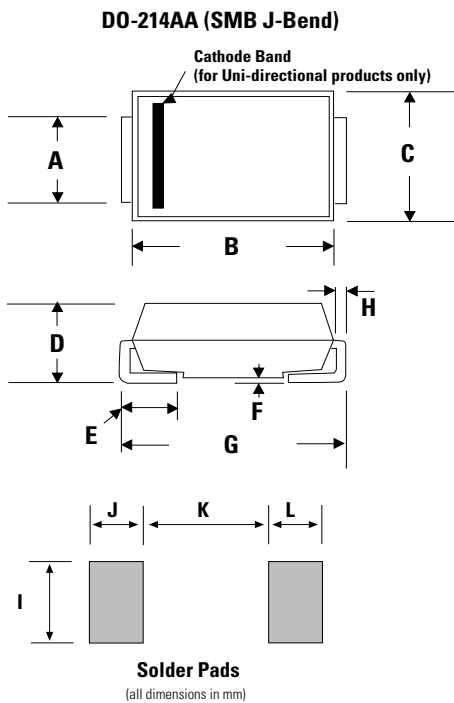
**Physical Specifications**

<b>Weight</b>	0.003 ounce, 0.093 grams
<b>Case</b>	JEDEC DO214AA. Molded plastic body over glass passivated junction
<b>Polarity</b>	Color band denotes cathode except for bidirectional versions
<b>Terminal</b>	Matte Tin-plated leads, Solderable per JESD22-B102

**Environmental Specifications**

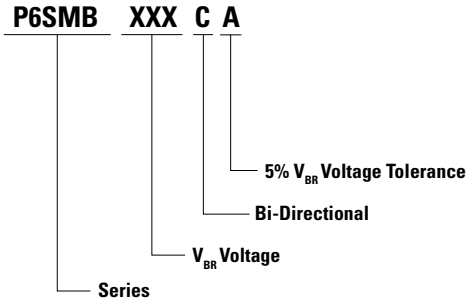
<b>High Temp. Storage</b>	JESD22-A103
<b>HTRB</b>	JESD22-A108
<b>Temperature Cycling</b>	JESD22-A104
<b>MSL</b>	JEDEC-J-STD-020, Level 1
<b>H3TRB</b>	JESD22-A101
<b>RSH</b>	JESD22-A111

**Dimensions**

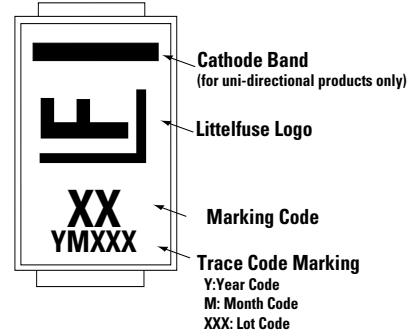


Dimensions	Inches		Millimeters	
	Min	Max	Min	Max
A	0.076	0.086	1.930	2.200
B	0.160	0.187	4.060	4.750
C	0.130	0.155	3.300	3.940
D	0.078	0.103	1.990	2.610
E	0.030	0.060	0.760	1.520
F	-	0.008	-	0.203
G	0.205	0.220	5.210	5.590
H	0.006	0.012	0.152	0.305
I	0.089	-	2.260	-
J	0.085	-	2.160	-
K	-	0.107	-	2.740
L	0.085	-	2.160	-

### Part Numbering System



### Part Marking System



### Packaging

Part number	Component Package	Quantity	Packaging Option	Packaging Specification
P6SMBxxxXX	DO-214AA	3000	Tape & Reel - 12mm tape/13" reel	EIA STD RS-481

### Tape and Reel Specification

