

### Features

- 2μA Ground Current at no Load
- ±2% Output Accuracy
- 600mA Output Current
- 10nA Disable Current ( by option )
- Wide Operating Input Voltage Range: 1.2V to 5.5V
- Dropout Voltage: 0.32V at 600mA/ V<sub>OUT</sub> 3.3V
- Support Fixed Output Voltage 1.2V, 1.5V, 1.6V, 1.8V, 2.5V, 2.8V, 3.0V, 3.3V
- Stable with Ceramic or Tantalum Capacitor
- Current Limit Protection
- Over Temperature Protection
- SOT23-5 Packages

### General Description

The RT9080 series are a group of low-dropout ( LDO ) voltage regulators offering the benefits of wide input voltage range from 1.2V to 5.5V, low dropout voltage, low power consumption, and miniaturized packaging. Quiescent current of only 2μA makes these devices ideal for powering the battery-powered, always-on systems that require very little idle-state power dissipation to a longer service life. There is an option of

shutdown mode by selecting the parts with the EN pin and pulling it low. The shutdown current in this mode goes down to only 10nA ( typical ).

The RT9080 series of linear regulators are stable with the ceramic output capacitor over its wide input range from 1.2V to 5.5V and the entire range of output load current ( 0mA to 600mA ).

### Ordering Information

## RT9080-33GJ5

GJ5: SOT23-5 Package

Output voltage: 12=1.2V  
15=1.5V  
18=1.8V  
30=3.0V  
33=3.3V  
XX=X.XV

### PIN CONFIGURATION

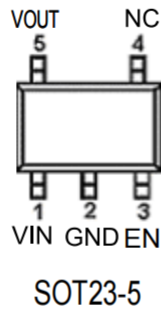

### Typical Application Circuit

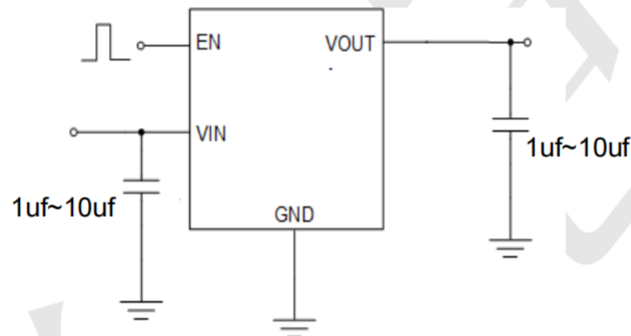

Figure 2: Application circuit of Fixed  $V_{OUT}$  LDO with enable function

### ABSOLUTE MAXIMUM RATINGS

VIN Pin to GND Pin Voltage .....	-0.3V to 6.5V
VOUT Pin and EN Voltage .....	-0.3V to 6V
VOUT Pin to VIN Pin Voltage .....	-6V to 0.3V
Storage Temperature Range .....	-60°C~150°C
Lead Temperature (Soldering, 10 sec) .....	260°C
Junction Temperature .....	150°C
Operating Ambient Temperature Range $T_A$ .....	-40°C~85°C
Thermal Resistance Junction to Case, $R_{\theta JC}$	
SOT23-3 .....	115°C/W
SOT23-5 .....	115°C/W
DFN-4(1x1) .....	65°C/W
DFN-6(2x2) .....	30°C/W
Thermal Resistance Junction to Ambient, $R_{\theta JA}$	
SOT23-3 .....	250°C/W
SOT23-5 .....	250°C/W
DFN-4(1x1) .....	195°C/W
DFN-6(2x2) .....	165°C/W

### Electrical Characteristics (T<sub>A</sub>=25°C unless otherwise noted)

(V<sub>IN</sub> = 5V, V<sub>EN</sub> = 5V T<sub>A</sub>=25°C unless otherwise specified)

Parameter	Symbol	Test Conditions	Min	Typ	Max	Unit	
Supply Voltage	V <sub>IN</sub>		1.2	--	5.5	V	
DC Output Voltage Accuracy		I <sub>LOAD</sub> = 0.1mA	-2		2	%	
Dropout Voltage (I <sub>LOAD</sub> = 600mA) (Note 3)	V <sub>DROP_3V</sub>	V <sub>OUT</sub> ≥ 3V		0.32		V	
	V <sub>DROP_2.8V</sub>	V <sub>OUT</sub> = 2.8V		0.36			
	V <sub>DROP_2.5V</sub>	V <sub>OUT</sub> = 2.5V		0.36			
	V <sub>DROP_1.8V</sub>	V <sub>OUT</sub> = 1.8V		0.57			
	V <sub>DROP_1.5V</sub>	V <sub>OUT</sub> = 1.5V		0.71			
	V	V = 1.2V		0.8			
Ground Current	I <sub>Q</sub>	I <sub>LOAD</sub> = 0mA		2		μA	
Shutdown Ground Current	I <sub>SD</sub>	V <sub>EN</sub> = 0V,		0.01	0.5	μA	
V <sub>OUT</sub> Shutdown Leakage Current	I <sub>LEAK</sub>	V <sub>OUT</sub> = 0V		0.01	0.5		
Enable Threshold Voltage	V <sub>IH</sub>	EN Rising			2	V	
	V <sub>IL</sub>	EN Falling	0.6				
EN Input Current	I <sub>EN</sub>	V <sub>EN</sub> = 5V		10	100	nA	
Line Regulation	Δ <sub>LINE</sub>	I <sub>LOAD</sub> = 30mA, 1.5V ≤ V <sub>IN</sub> ≤ 5.5V or (V <sub>OUT</sub> + 0.2V) ≤ V <sub>IN</sub> ≤ 5.5V		0.2		%	
Load Regulation	Δ <sub>LOAD</sub>	10mA ≤ I <sub>LOAD</sub> ≤ 0.3A		0.2		%	
Output Current Limit	I <sub>LIM</sub>	V <sub>OUT</sub> = 0	601	1100		mA	
Power Supply Rejection Ratio (I <sub>LOAD</sub> = 5mA)	PSRR	V <sub>OUT</sub> = 1.2V, V <sub>IN</sub> = 2V	f = 100Hz	--	80	--	dB
			f = 1kHz	--	75	--	
Output Voltage Noise (BW = 10Hz to 100kHz, C <sub>OUT</sub> = 1μF.)		V <sub>IN</sub> = 3.5V I <sub>LOAD</sub> = 0.1A	V <sub>OUT</sub> = 0.9V	--	40	--	μV <sub>RMS</sub>
			V <sub>OUT</sub> = 2.8V	--	50	--	
Thermal Shutdown Temperature	T <sub>SD</sub>	I <sub>LOAD</sub> = 10mA		--	155	--	°C
Thermal Shutdown Hysteresis	ΔT <sub>SD</sub>			--	15	--	°C
Discharge Resistance		EN = 0V, V <sub>OUT</sub> = 0.1V	--	100	--	Ω	

**Note 1.** Stresses beyond those listed “Absolute Maximum Ratings” may cause permanent damage to the device. These are stress ratings only, and functional operation of the device at these or any other conditions beyond those indicated in the operational sections of the specifications is not implied. Exposure to absolute maximum rating conditions may affect device reliability.

**Note 2.**  $\theta_{JA}$  is measured at  $T_A = 25^\circ\text{C}$  on a TECH PUBLICboard.

**Note 3.**  $V_{DROP} = V_{IN} - V_{OUT}$  when the  $V_{OUT}$  is 98% of its target value.

**Typical Characteristics**

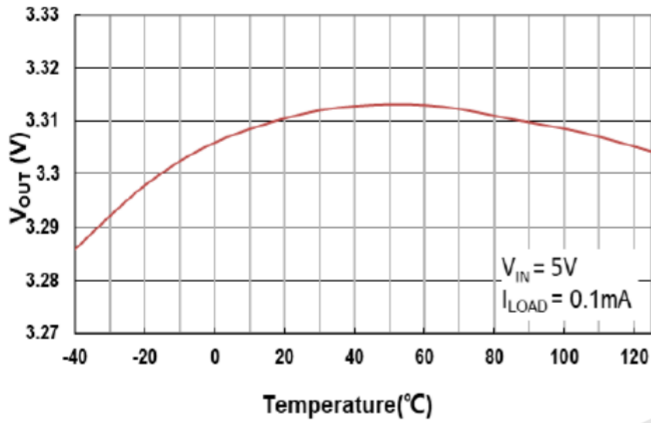

Fig. 5 Output Voltage vs. Temperature

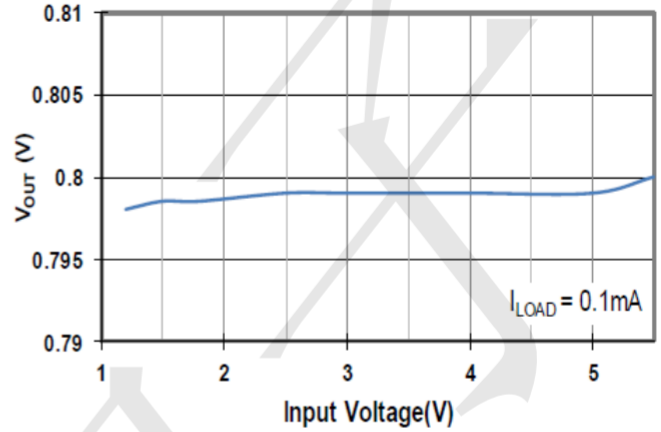

Fig. 6 Output Voltage vs. Input Voltage

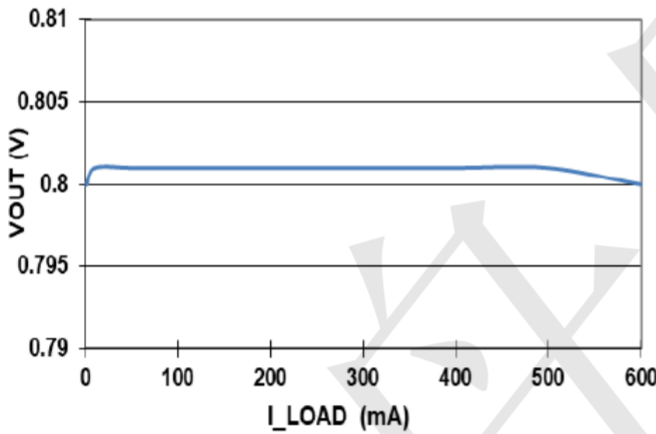

Fig. 7 Output Voltage vs. Load Current

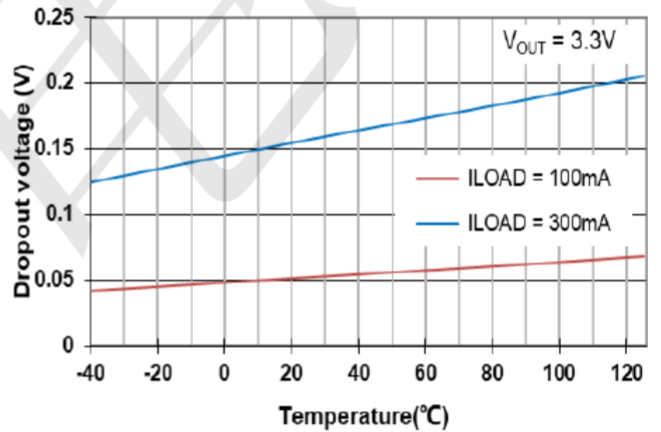

Fig. 8 Dropout Voltage vs. Temperature

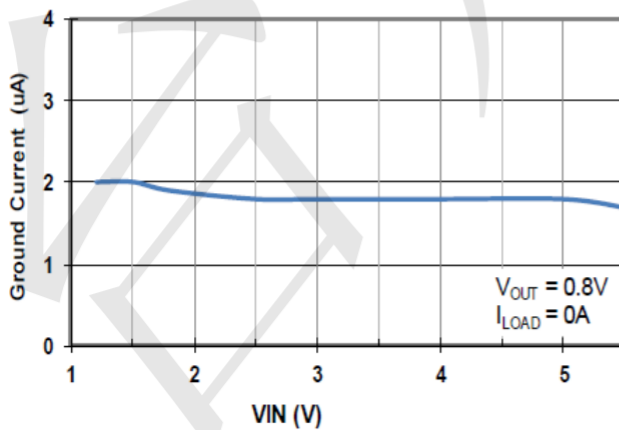

Fig. 9 Ground Current vs. Input Voltage

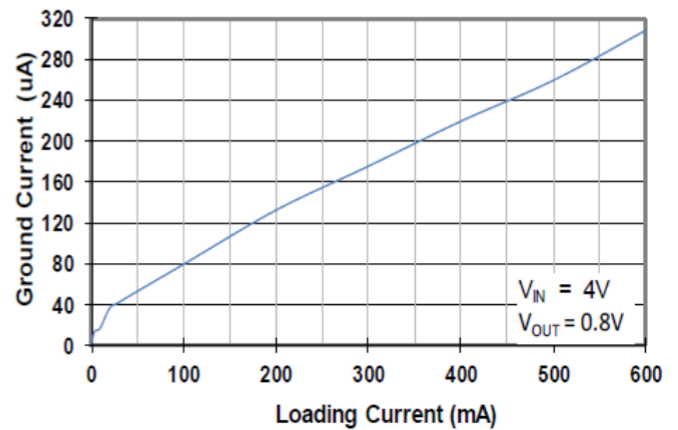
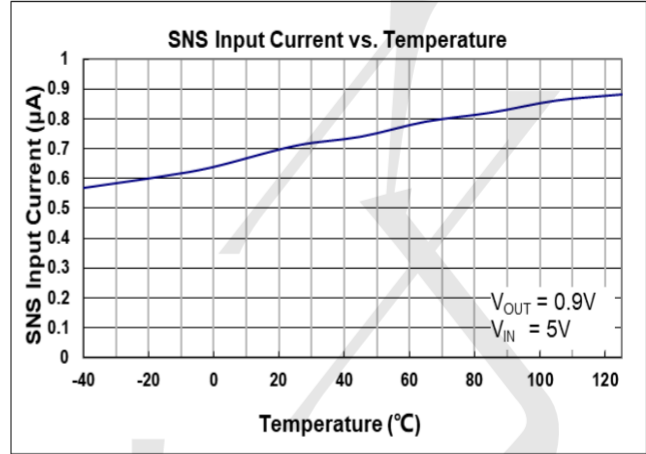
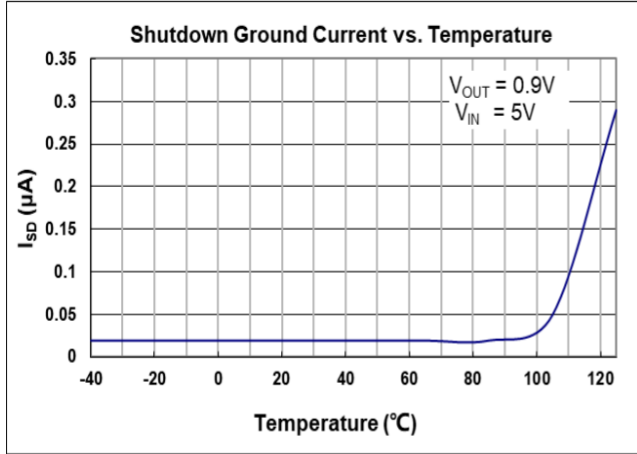
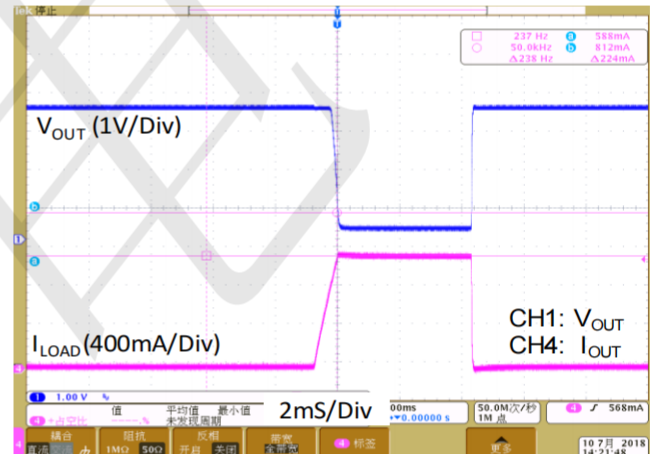
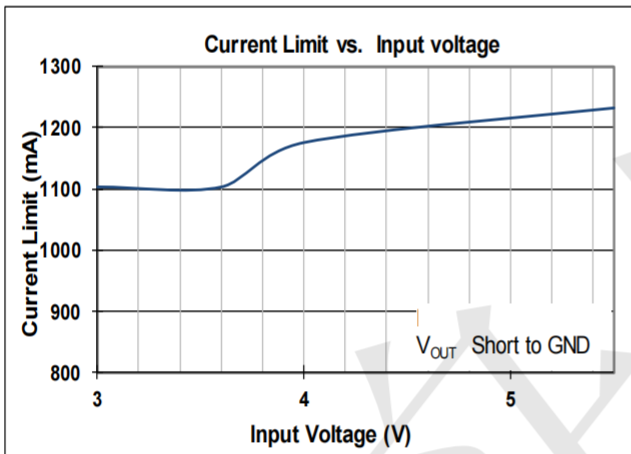

Fig. 10 Ground Current vs. Loading Current



### Current Limit Response



### Load Transient Response I

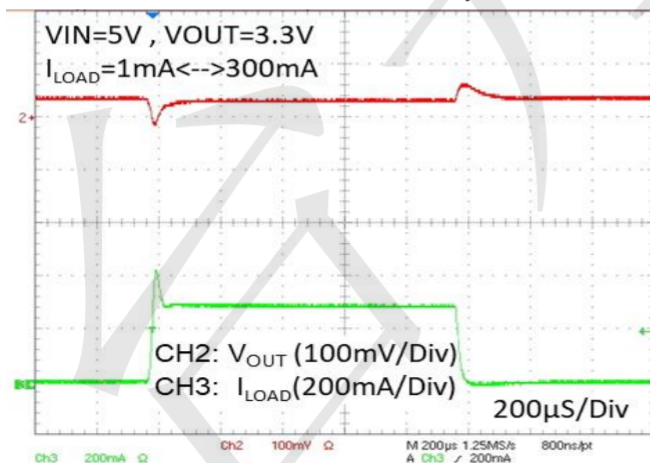

### Load Transient Response II

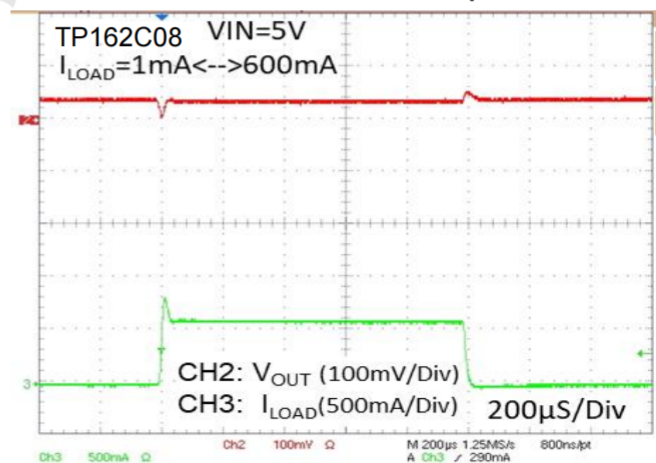



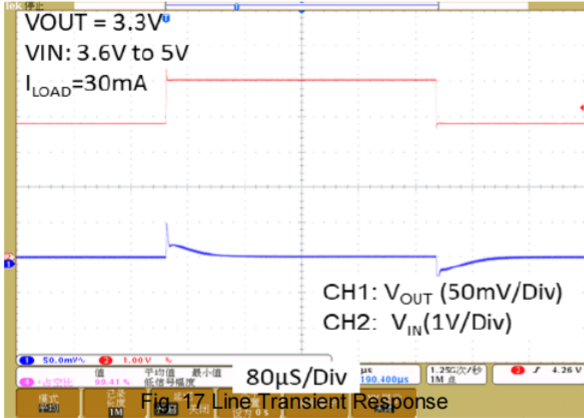

Fig. 17 Line Transient Response

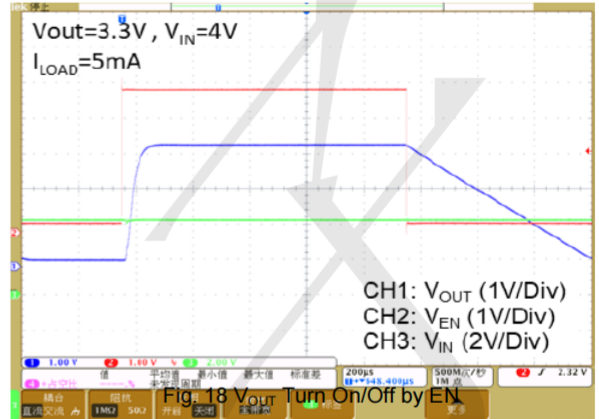
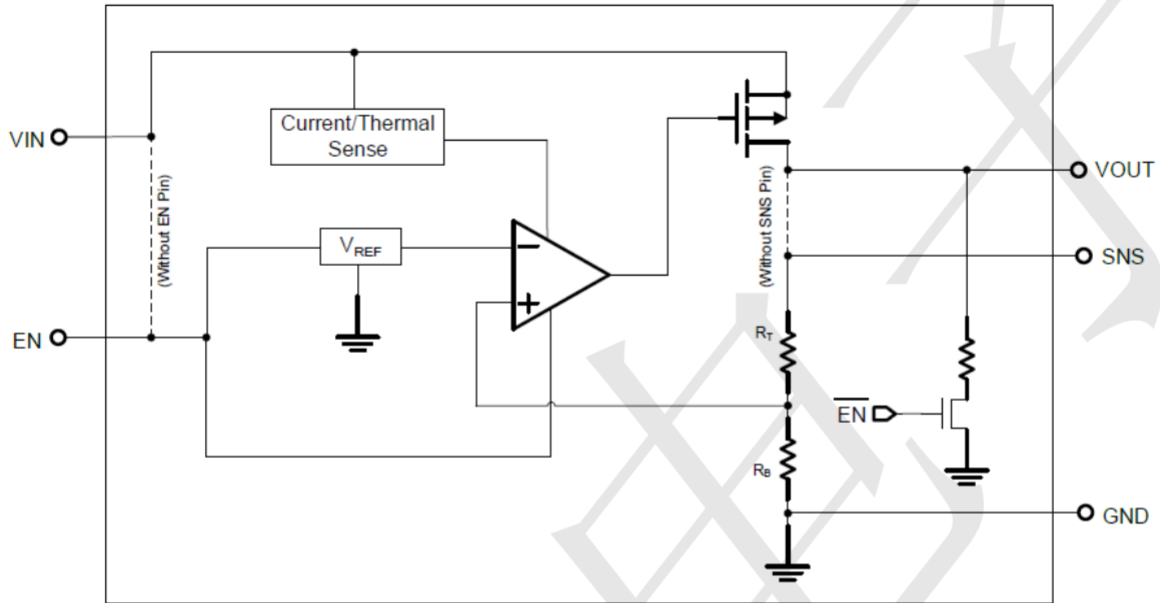

Fig. 18 V<sub>OUT</sub> Turn On/Off by EN

**BLOCK DIAGRAM**





**Package informantion**

SOT23-5

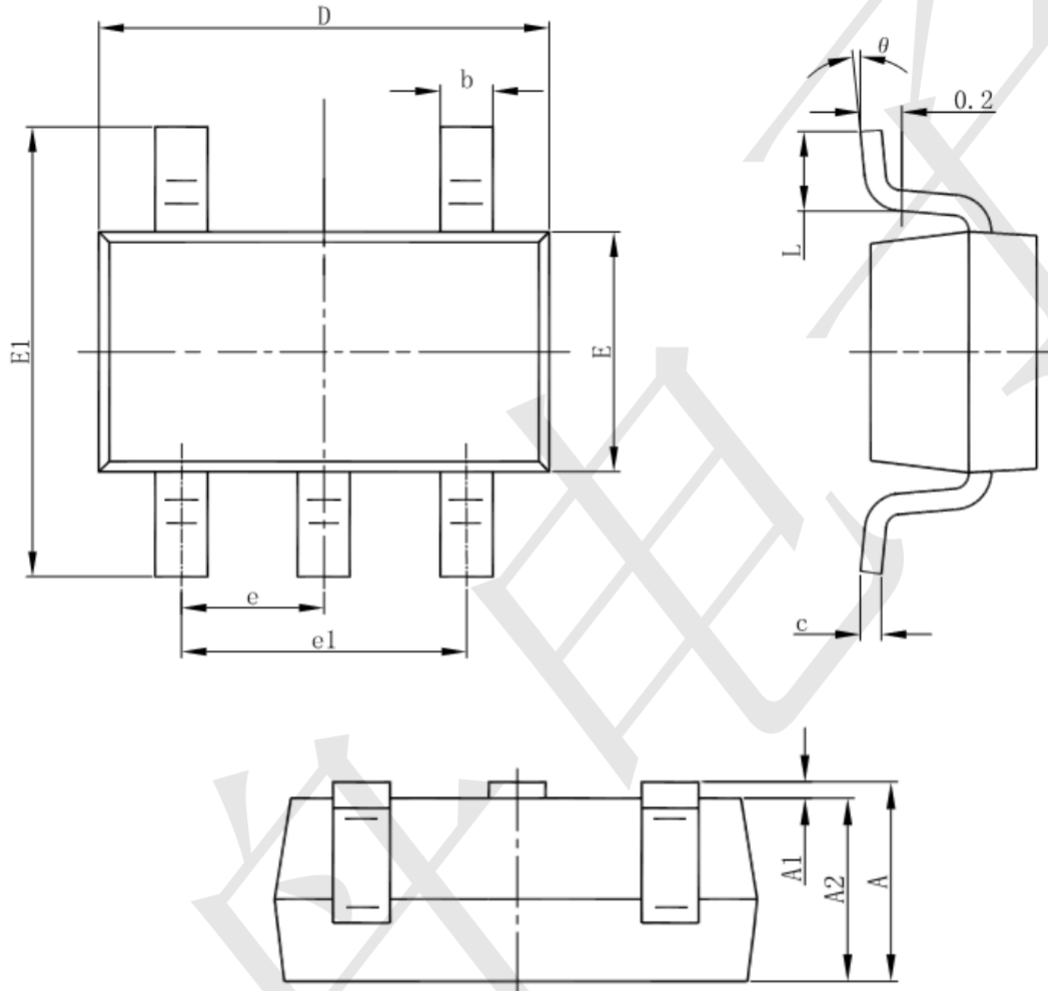

Symbol	Dimensions In Millimeters		Dimensions In Inches	
	Min	Max	Min	Max
A	1.050	1.250	0.041	0.049
A1	0.000	0.100	0.000	0.004
A2	1.050	1.150	0.041	0.045
b	0.300	0.500	0.012	0.020
c	0.100	0.200	0.004	0.008
D	2.820	3.020	0.111	0.119
E	1.500	1.700	0.059	0.067
E1	2.650	2.950	0.104	0.116
e	0.950(BSC)		0.037(BSC)	
e1	1.800	2.000	0.071	0.079
L	0.300	0.600	0.012	0.024
$\theta$	0°	8°	0°	8°