

## Features

- 200W peak pulse power (8/20 $\mu$ s)
- Ultra low leakage: nA level
- Operating voltage: 7V or 12V
- Low clamping voltage
- Complies with following standards:
  - IEC 61000-4-2 (ESD) immunity test  
Air discharge:  $\pm 30$ kV  
Contact discharge:  $\pm 30$ kV
  - IEC61000-4-4 (EFT) 40A (5/50ns)
  - IEC61000-4-5 (Lightning) 8A (8/20 $\mu$ s)
- RoHS Compliant

## Mechanical Characteristics

- Package: SOT-23
- Lead Finish: Matte Tin
- Case Material: "Green" Molding Compound.
- UL Flammability Classification Rating 94V-0
- Moisture Sensitivity: Level 3 per J-STD-020
- Terminal Connections: See Diagram Below
- Shipping Qty : 3000pcs/7Inch Tape & Reel

## Applications

- Wireless System
- Networks
- Portable Instrumentation
- RS485 Ports

## Dimensions and Pin Configuration

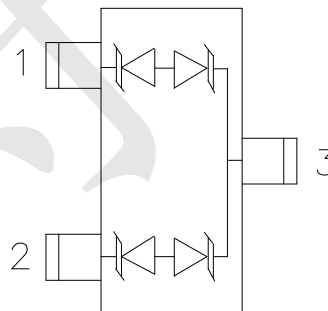
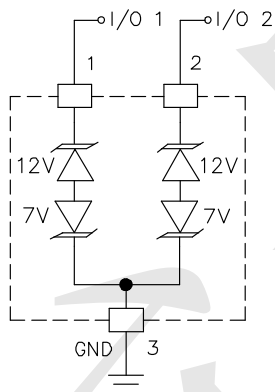

## Marking:

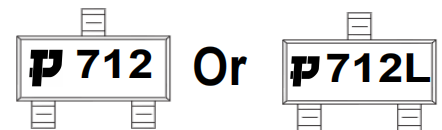

**Absolute Maximum Ratings** (Tamb=25°C unless otherwise specified)

Parameter	Symbol	Value	Unit
Peak Pulse Power (8/20μs)	Ppk	200	W
Peak Pulse Current (8/20μs)	Ipp	8	A
ESD per IEC 61000-4-2 (Air)	VESD	±30	kV
ESD per IEC 61000-4-2 (Contact)		±30	
Operating Temperature Range	TJ	-55 to +125	°C
Storage Temperature Range	Tstg	-55 to +150	°C

**Electrical Characteristics** (TA=25°C unless otherwise specified)

Parameter	Symbol	Pin 1 to 3 and 2 to 3 (12V TVS)			Pin 3 to 1 and 3 to 2 (7V TVS)			Unit	Test Condition
		Min	Typ	Max	Min	Typ	Max		
Reverse Working Voltage	VRWM			12			7	V	
Breakdown Voltage	VBR	13.3			7.5			V	IT = 1mA
Reverse Leakage Current	IR			0.1			1	uA	VR = VRWM
Clamping Voltage	VC			20			13	V	I <sub>PP</sub> = 1A(8 x20us pulse)
Clamping Voltage	VC		22	26		16	20	V	I <sub>PP</sub> = 8A(8 x20us pulse)
Junction Capacitance	CJ			75			75	pF	VR = 0V, f = 1MHz

**Typical Performance Characteristics ( $T_A=25^\circ\text{C}$  unless otherwise Specified)**

**Fig1. 8/20 $\mu\text{s}$  Pulse Waveform**

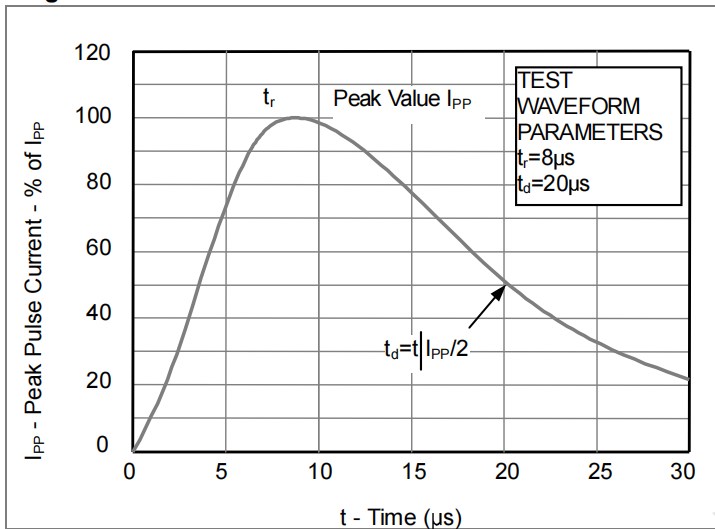

**Fig2. ESD Pulse Waveform (according to IEC 61000-4-2)**

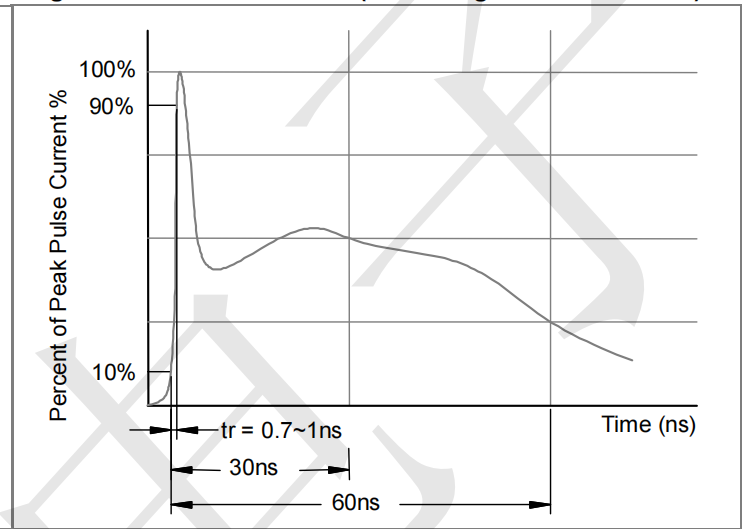

**Fig3. Power Derating Curve**

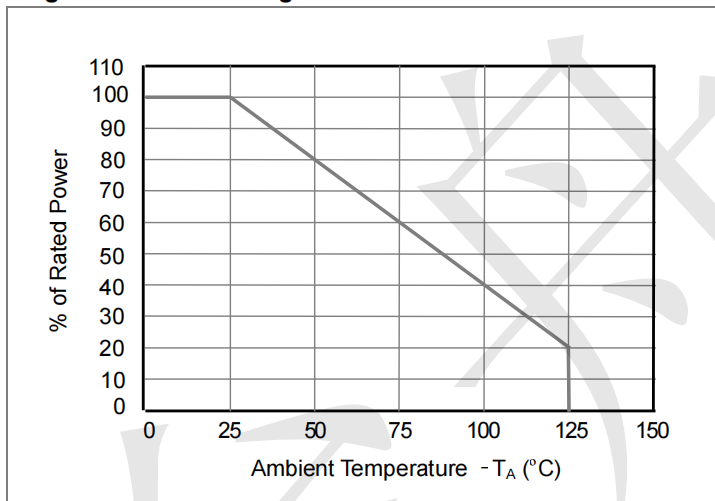

### Outline Drawing - SOT23

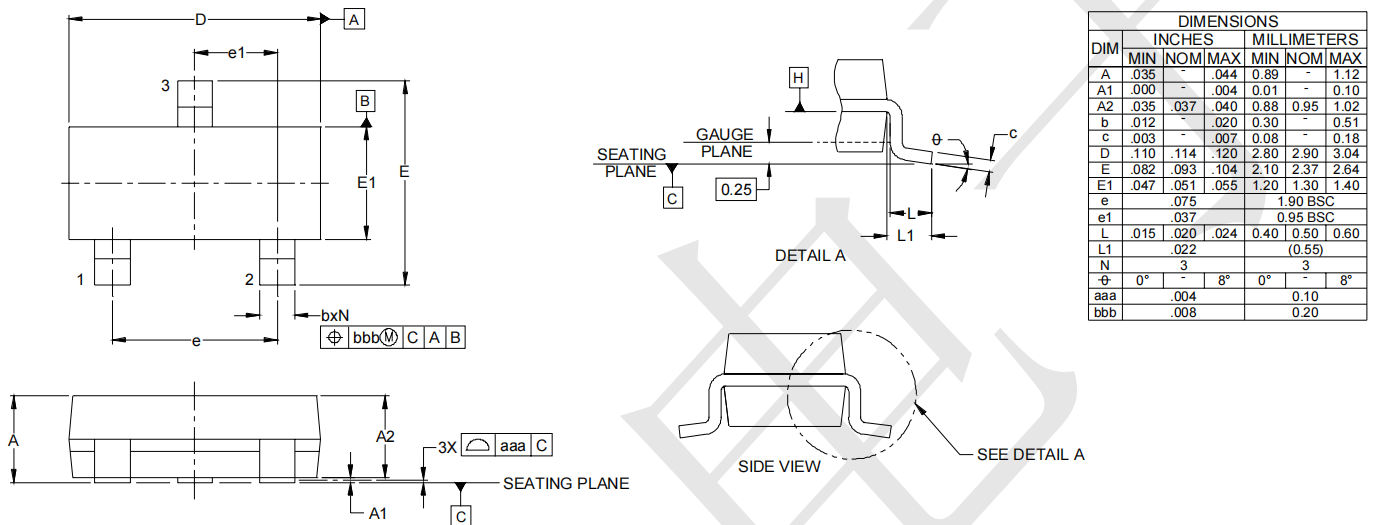

### Land Pattern - SOT23

