

## Features

- \* 300W peak pulse power (8/20 $\mu$ s)
- \* Low operating :3.3V
- \* Ultra low capacitance: 0.8pF typical
- \* Ultra low leakage: nA level
- \* Low clamping voltage
- \* Protects one power line or data line
- \* Complies with following standards:
  - IEC 61000-4-2 (ESD) immunity test  
Air discharge:  $\pm$ 30kV  
Contact discharge:  $\pm$ 30kV
  - IEC61000-4-4 (EFT) 40A (5/50ns)
- \* RoHS Compliant

## Mechanical Characteristics

- \* Package: SOD.323
- \* Lead Finish: Matte Tin
- \* Case Material: “Green” Molding Compound.
- \* UL Flammability Classification Rating 94V-0
- \* Moisture Sensitivity: Level 3 per J-STD-020
- \* Terminal Connections: See Diagram Below
- \* Shipping Qty :3000pcs/7Inch Tape & Reel

## Applications

- \* USB Ports
- \* Smart Phones
- \* Wireless Systems
- \* Ethernet 10/100/1000 Base T

## Dimensions and Pin Configuration

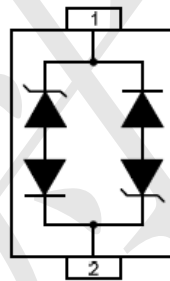

**Marking: CC Or CCL**

**Absolute Maximum Ratings** (Tamb=25°C unless otherwise specified)

Parameter	Symbol	Value	Unit
ESD per IEC 61000-4-2 (Air)	VESD	±30	kV
ESD per IEC 61000-4-2 (Contact)		±30	
Operating Temperature Range	TJ	-55 to +125	°C
Storage Temperature Range	Tstg	-55 to +150	°C

**Electrical Characteristics** (TA=25°C unless otherwise specified)

Symbol	Parameter
$V_{RWM}$	Nominal Reverse Working Voltage
$I_R$	Reverse Leakage Current @ $V_{RWM}$
$V_{BR}$	Reverse Breakdown Voltage @ $I_T$
$I_T$	Test Current for Reverse Breakdown
$V_C$	Clamping Voltage @ $I_{PP}$
$I_{PP}$	Maximum Peak Pulse Current
$C_{ESD}$	Parasitic Capacitance
$V_R$	Reverse Voltage
f	Small Signal Frequency

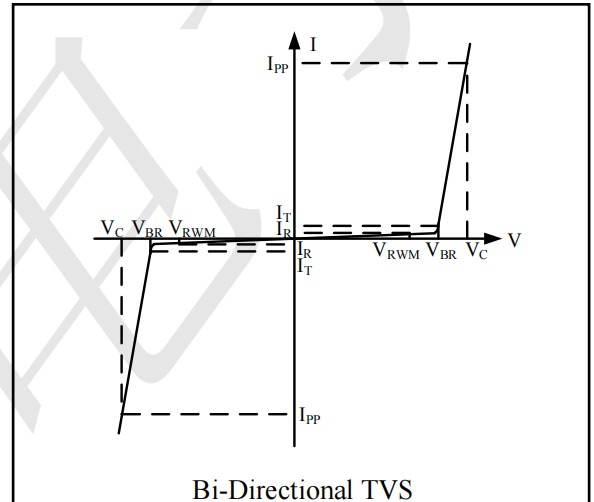

Parameter	Symbol	Test Condition	Min	Typ	Max	Unit
Reverse Working Voltage	$V_{RWM}$				3.3	V
Breakdown Voltage	$V_{BR}$	$I_T = 1mA$	4			V
Reverse Leakage Current	$I_R$	$V_{RWM} = 3.3V$			0.2	μA
Clamping Voltage	$V_C$	$I_{PP} = 1A$ (8 x 20μs pulse)			9	V
Clamping Voltage	$V_C$	$I_{PP} = 15A$ (8 x 20us pulse)		16		V
Junction Capacitance	$C_J$	$V_R = 0V, f = 1MHz$		0.8		pF

**Electrical Characteristics ( $T_A=25^\circ\text{C}$  unless otherwise specified)**

**Fig1. 8/20 $\mu\text{s}$  Pulse Waveform**

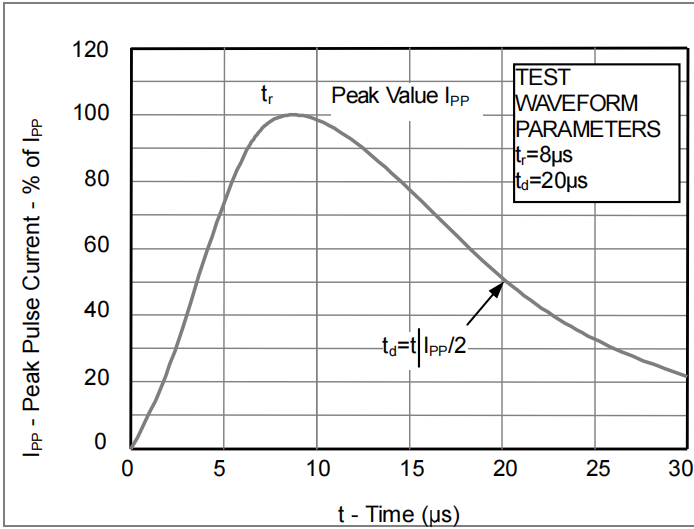

**Fig2. ESD Pulse Waveform (according to IEC 61000-4-2)**

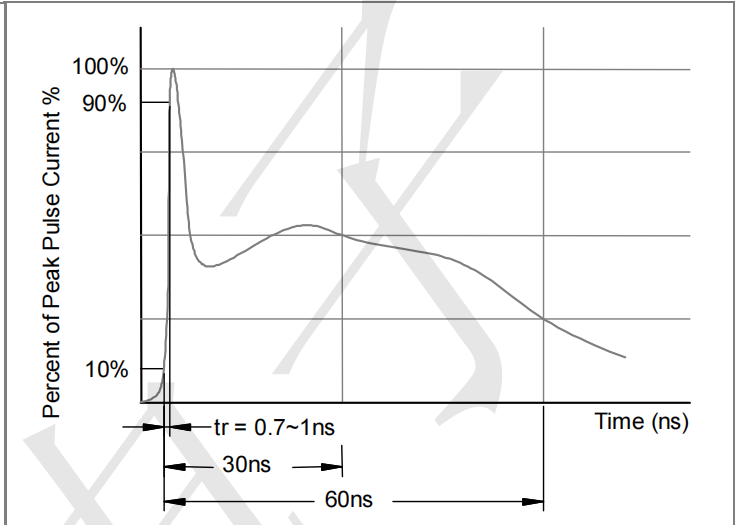

**Fig3. Power Derating Curve**

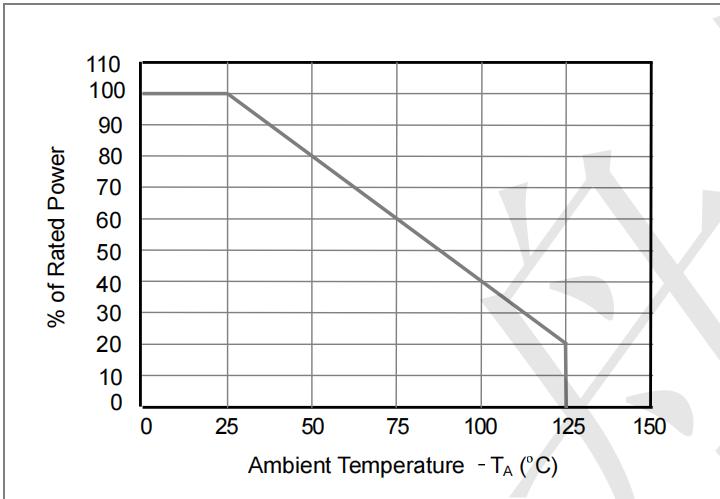

**Outline Drawing - SOD-323**

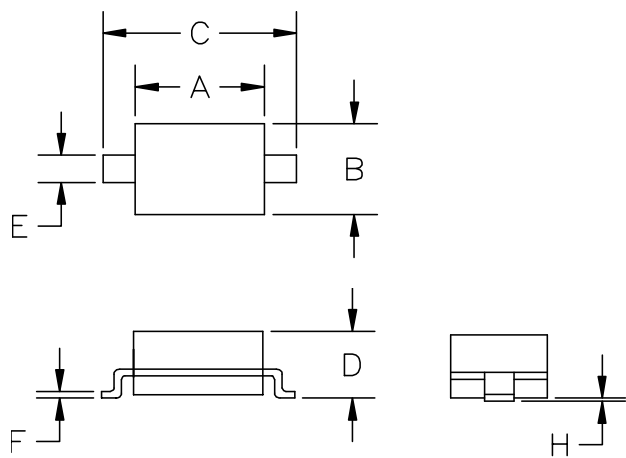

SYM	DIMENSIONS			
	MILLIMETERS		INCHES	
	MIN	MAX	MIN	MAX
A	1.50	1.80	0.060	0.071
B	1.20	1.40	0.045	0.054
C	2.30	2.70	0.090	0.107
D	-	1.10	-	0.043
E	0.30	0.40	0.012	0.016
F	0.10	0.25	0.004	0.010
H	-	0.10	-	0.004

**Land Pattern - SOD-323**

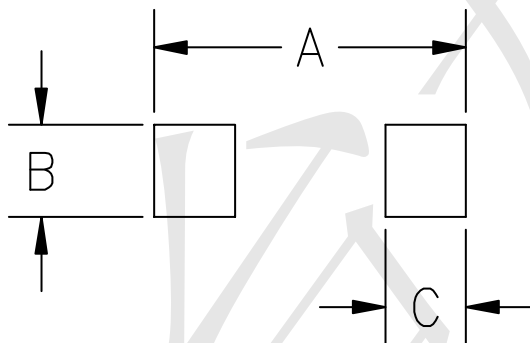

SYM	DIMENSIONS	
	MILLIMETERS	INCHES
A	3.15	0.120
B	0.80	0.031
C	0.80	0.031