

NM34C02

2K-Bit Standard 2-Wire Bus Interface

Designed with Permanent Write-Protection for First 128 Bytes for Serial Presence Detect Application on Memory Modules

General Description

The NM34C02 is 2048 bits of CMOS non-volatile electrically erasable memory. It is designed to support Serial Presence Detect circuitry in memory modules. This communications protocol uses CLOCK (SCL) and DATA I/O (SDA) lines to synchronously clock data between the master (for example a microprocessor) and the slave EEPROM device(s).

The contents of the non-volatile memory allows the CPU to determine the capacity of the module and the electrical characteristics of the memory devices it contains. This will enable "plug and play" capability as the module is read and PC main memory resources utilized through the memory controller.

The first 128 bytes of the memory of the NM34C02 can be permanently Write Protected by writing to the "WRITE PROTECT" Register. Write Protect implementation details are described under the section titled **Addressing the WP Register**.

The NM34C02 is available in a JEDEC standard TSSOP package for low profile memory modules for systems requiring efficient space utilization such as in a notebook computer. Two options are available: L - Low Voltage and LZ - Low Power, allowing the part to be used in systems where battery life is of primary importance.

Features

- Extended Operating Voltage: 2.7V-5.5V
- Write-Protection for first 128 bytes
- 200 μ A active current typical
 - 10 μ A standby current typical
 - 1.0 μ A standby current typical (L)
 - 0.1 μ A standby current typical (LZ)
- IIC compatible interface
 - Provides bidirectional data transfer protocol
- Sixteen byte page write mode
 - Minimizes total write time per byte
- Self timed write cycle
 - Typical write cycle time of 6ms
- Endurance: 1,000,000 data changes
- Data retention greater than 40 years
- Packages available: 8-pin TSSOP and 8-pin SO

Block Diagram

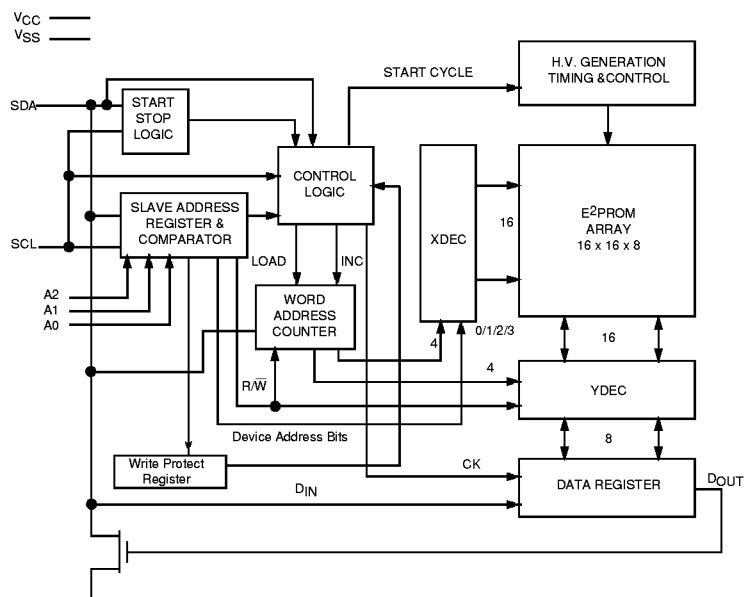

DS012821-1

Connection Diagram

SO (M8) and TSSOP (MT8) Package

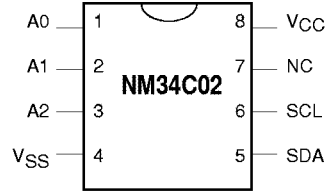

DS012821-2

Top View
See Package Number
M08A and MTC08

Pin Names	
A0,A1,A2	Device Address Inputs
V _{SS}	Ground
SDA	Data I/O
SCL	Clock Input
NC	No Connection
V _{CC}	Power Supply

Ordering Information

NM34C02 XX X X

Package

M8 = 8 pin SOIC
 MT8 = 8 pin TSSOP

Temperature Range

Blank = 0°C to +70°C
 E = -40°C to +85°C

Voltage Range

Blank = 4.5V to 5.5V
 L = 2.7V to 4.5V
 LZ = 2.7V to 4.5V and < 1µA standby current

Device

2K IIC Serial EEPROM

DS012821-21

Product Specifications

Absolute Maximum Ratings

Ambient Storage Temperature	-65°C to +150°C
All Input or Output Voltages with Respect to Ground	6.5V to -0.3V
Lead Temperature (Soldering, 10 seconds)	+300°C
ESD Rating	2000V min.

Operating Conditions

Ambient Operating Temperature	0°C to +70°C
NM34C02	-40°C to +85°C
NM34C02E	
Positive Power Supply	
NM34C02	4.5V to 5.5V
NM34C02L	2.7V to 4.5V
NM34C02LZ	2.7V to 4.5V

Standard V_{CC} (4.5V to 5.5V) DC Electrical Characteristics

Symbol	Parameter	Test Conditions	Limits			Units
			Min	Typ (Note 1)	Max	
I _{CCA}	Active Power Supply Current	f _{SCL} = 100 kHz		0.2	1.0	mA
I _{SB}	Standby Current	V _{IN} = GND or V _{CC}		10	50	μA
I _{LI}	Input Leakage Current	V _{IN} = GND to V _{CC}		0.1	1	μA
I _{LO}	Output Leakage Current	V _{OUT} = GND to V _{CC}		0.1	1	μA
V _{IL}	Input Low Voltage		-0.3		V _{CC} × 0.3	V
V _{IH}	Input High Voltage		V _{CC} × 0.7		V _{CC} + 0.5	V
V _{OL}	Output Low Voltage	I _{OL} = 3 mA			0.4	V

Low V_{CC} (2.7V to 5.5V) DC Electrical Characteristics

Symbol	Parameter	Test Conditions	Limits			Units
			Min	Typ (Note 1)	Max	
I _{CCA}	Active Power Supply Current	f _{SCL} = 100 kHz		0.2	1.0	mA
I _{SB}	Standby Current for L	V _{IN} = GND or V _{CC}		1	10	μA
	Standby Current for LZ	V _{IN} = GND or V _{CC}		0.1	1	μA
I _{LI}	Input Leakage Current	V _{IN} = GND to V _{CC}		0.1	1	μA
I _{LO}	Output Leakage Current	V _{OUT} = GND to V _{CC}		0.1	1	μA
V _{IL}	Input Low Voltage		-0.3		V _{CC} × 0.3	V
V _{IH}	Input High Voltage		V _{CC} × 0.7		V _{CC} + 0.5	V
V _{OL}	Output Low Voltage	I _{OL} = 3 mA			0.4	V

Capacitance T_A = +25°C, f = 100/400 KHz, V_{CC} = 5V (Note 2)

Symbol	Test	Conditions	Max	Units
C _{I/O}	Input/Output Capacitance (SDA)	V _{I/O} = 0V	8	pF
C _{IN}	Input Capacitance (A0, A1, A2, SCL)	V _{IN} = 0V	6	pF

Note 1: Typical values are T_A = 25°C and nominal supply voltage (5V).

Note 2: This parameter is periodically sampled and not 100% tested.

AC Conditions of Test

Input Pulse Levels	$V_{CC} \times 0.1$ to $V_{CC} \times 0.9$
Input Rise and Fall Times	10 ns
Input & Output Timing Levels	$V_{CC} \times 0.5$
Output Load	1 TTL Gate and $C_L = 100$ pF

Read and Write Cycle Limits (Standard and Low V_{CC} Range 2.7V - 4.5V)

Symbol	Parameter	100 KHz		400 KHz		Units
		Min	Max	Min	Max	
f_{SCL}	SCL Clock Frequency		100		400	KHz
T_I	Noise Suppression Time Constant at SCL, SDA Inputs (Minimum V_{IN} Pulse width)		100		50	ns
t_{AA}	SCL Low to SDA Data Out Valid	0.3	3.5	0.1	0.9	μ s
t_{BUF}	Time the Bus Must Be Free before a New Transmission Can Start	4.7		1.3		μ s
$t_{HD:STA}$	Start Condition Hold Time	4.0		0.6		μ s
t_{LOW}	Clock Low Period	4.7		1.5		μ s
t_{HIGH}	Clock High Period	4.0		0.6		μ s
$t_{SU:STA}$	Start Condition Setup Time (for a Repeated Start Condition)	4.7		0.6		μ s
$t_{HD:DAT}$	Data in Hold Time	0		0		μ s
$t_{SU:DAT}$	Data in Setup Time	250		100		ns
t_R	SDA and SCL Rise Time		1		0.3	μ s
t_F	SDA and SCL Fall Time		300		300	ns
$t_{SU:STO}$	Stop Condition Setup Time	4.7		0.6		μ s
t_{DH}	Data Out Hold Time	300		50		ns
t_{WR} (Note 3)	Write Cycle Time - NM34C02 - NM34C02L, NM34C02LZ		10 15		10 15	ms

Note 3: The write cycle time (t_{WR}) is the time from a valid stop condition of a write sequence to the end of the internal erase/program cycle. During the write cycle, the NM34C02 bus interface circuits are disabled, SDA is allowed to remain high per the bus-level pull-up resistor, and the device does not respond to its slave address.

Bus Timing

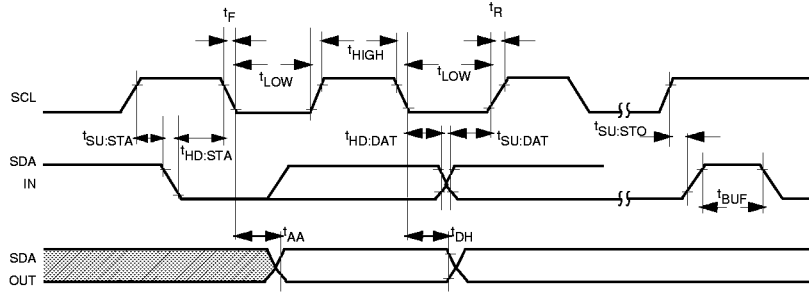

DS012821-4

Background Information (IIC Bus)

As mentioned, the IIC bus allows synchronous bidirectional communication between Transmitter/Receiver using the SCL (clock) and SDA (Data I/O) lines. All communication must be started with a valid START condition, concluded with a STOP condition and acknowledged by the Receiver with an ACKNOWLEDGE condition.

In addition, since the IIC bus is designed to support other devices such as RAM, EPROMs, etc., a device type identifier string must follow the START condition. For EEPROMs, this 4-bit string is 1010. Also refer the **Addressing the WP Register** section.

As shown below, although the EEPROMs on the IIC bus may be configured in any manner required, the total memory addressed can not exceed 16K (16,384 bits) on the Standard IIC protocol. EEPROM memory address programming is controlled by 2 methods:

- Hardware configuring the A0, A1, and A2 pins (Device Address pins) with pull-up or pull-down resistors. **All unused pins must be grounded** (tied to V_{SS}).
- Software addressing the required PAGE BLOCK within the device memory array (as sent in the Slave Address string). Addressing an EEPROM memory location involves sending a command string with the following information:

[DEVICE TYPE]—[DEVICE ADDRESS]—[PAGE BLOCK ADDRESS]—[BYTE ADDRESS]

DEFINITIONS

BYTE	8 bits of data
PAGE	16 sequential addresses (one byte each) that may be programmed during a 'Page Write' programming cycle
PAGE BLOCK	2,048 (2K) bits organized into 16 pages of addressable memory. (8 bits) x (16 bytes) x (16 pages) = 2,048 bits
MASTER	Any IIC device CONTROLLING the transfer of data (such as a microprocessor)
SLAVE	Device being controlled (EEPROMs are always considered Slaves)
TRANSMITTER	Device currently SENDING data on the bus (may be either a Master or Slave).
RECEIVER	Device currently receiving data on the bus (Master or Slave)

Example of 16K of Memory on 2-Wire Bus

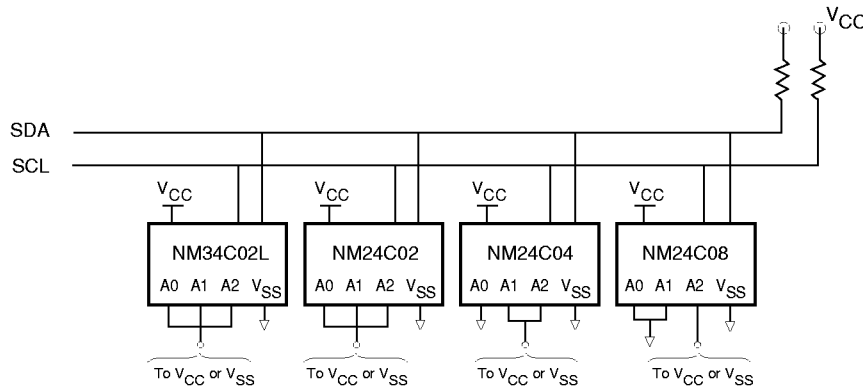

DS012821-5

Note: The SDA pull-up resistor is required due to the open-drain/open collector output of IIC bus devices. The SCL pull-up resistor is recommended because of the normal SCL line inactive 'high' state. It is recommended that the total line capacitance be less than 400pF. Specific timing and addressing considerations are described in greater detail in the following sections.

Device	Address Pins			Memory Size	Number of Page Blocks
	A0	A1	A2		
NM34C02	ADR	ADR	ADR	2048 Bits	1

Pin Descriptions

Serial Clock (SCL)

The SCL input is used to clock all data into and out of the device.

Serial Data (SDA)

SDA is a bidirectional pin used to transfer data into and out of the device. It is an open drain output and may be wire-ORed with any number of open drain or open collector outputs.

Device Operation Inputs (A0, A1, A2)

Device address pins A0, A1, and A2 are connected to V_{CC} or V_{SS} to configure the EEPROM chip address. Table A shows the active pins across the NM34C02 device family.

Table 1.

Device	A0	A1	A2	Effects of Addresses
NM34C02L	ADR	ADR	ADR	8 devices max.

Device Operation

The NM34C02 supports a bidirectional bus oriented protocol. The protocol defines any device that sends data onto the bus as a transmitter and the receiving device as the receiver. The device controlling the transfer is the master and the device that is controlled is the slave. The master will always initiate data transfers and provide the clock for both transmit and receive operations. Therefore, the NM34C02 will be considered a slave in all applications.

Clock and Data Conventions

Data states on the SDA line can change only during SCL LOW. SDA state changes during SCL HIGH are reserved for indicating start and stop conditions. Refer to *Figures 1 and 2*.

Start Condition

All commands are preceded by the start condition, which is a HIGH to LOW transition of SDA when SCL is HIGH. The NM34C02 continuously monitors the SDA and SCL lines for the start condition and will not respond to any command until this condition has been met.

Stop Condition

All communications are terminated by a stop condition, which is a LOW to HIGH transition of SDA when SCL is HIGH. The stop condition is also used by the NM34C02 to place the device in the standby power mode.

ACKNOWLEDGE

Acknowledge is a software convention used to indicate successful data transfers. The transmitting device, either master or slave, will release the bus after transmitting eight bits.

During the ninth clock cycle the receiver will pull the SDA line to LOW to acknowledge that it received the eight bits of data. Refer to *Figure 3*.

The NM34C02 device will always respond with an acknowledge after recognition of a start condition and its slave address. If both the device and a write operation have been selected, the NM34C02 will respond with an acknowledge after the receipt of each subsequent eight bit byte.

In the Read mode the NM34C02 slave will transmit eight bits of data, release the SDA line and monitor the line for an acknowledge. If an acknowledge is detected and no stop condition is generated by the master, the slave will continue to transmit data. If an acknowledge is not detected, the slave will terminate further data transmissions and await the stop condition to return to the standby power mode.

Write Cycle Timing

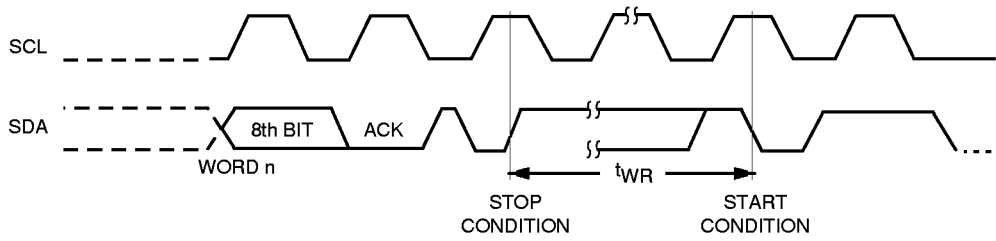

DS012821-6

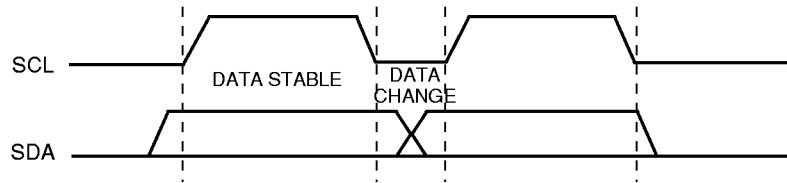

DS012821-7

Data Validity (Figure 1).

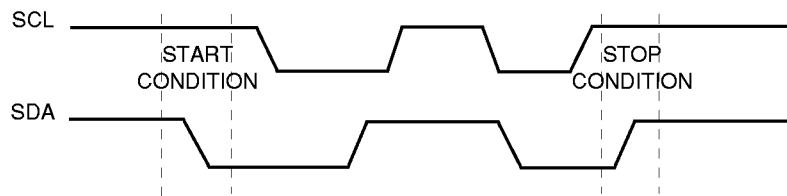

DS012821-8

Start and Stop Definition (Figure 2).

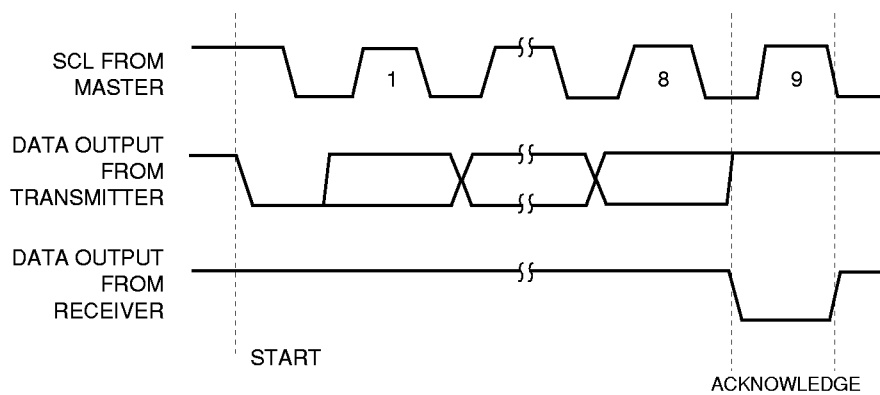

DS012821-9

Acknowledge Responses from Receiver (Figure 3).

Device Addressing

Following a start condition the master must output the address of the slave it is accessing. The most significant four bits of the slave address are those of the device type identifier (see Figure 4). This is fixed as 1010 for all EEPROM devices.

All IIC EEPROMs use an internal protocol that defines a PAGE BLOCK size of 2K bits (for Byte addresses 00 through FF).

Device Addressing (Continued)

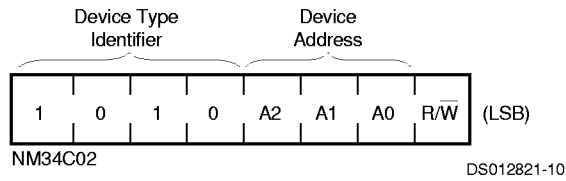

Slave Addresses (Figure 4).

Refer to the following table for Slave Address string details:

Device	A0	A1	A2	Page Blocks	Page Block Addresses
NM34C02	A	A	A	1 (2K)	(None)

Write Operations

The last bit of the slave address defines whether a write or read condition is requested by the master. A '1' indicates that a read operation is to be executed, and a '0' initiates the write mode.

A simple review: After the NM34C02 recognizes the start condition, the devices interfaced to the IIC bus wait for a slave address to be transmitted over the SDA line. If the transmitted slave address matches an address of one of the devices, the designated slave pulls the line LOW with an acknowledge signal and awaits further transmissions.

Byte Write

For a write operation a second address field is required which is a byte address that is comprised of eight bits and provides access to any one of the 256 bytes in the selected page block of memory. Upon receipt of the byte address the NM34C02 responds with an acknowledge and waits for the next eight bits of data, again, responding with an acknowledge. The master then terminates the transfer by generating a stop condition, at which time the NM34C02 begins the internal write cycle to the nonvolatile memory. While the internal write cycle is in progress the NM34C02 inputs are disabled, and the device will not respond to any requests from the master. Refer to *Figure 5* for the address, acknowledge and data transfer sequence.

Page Write

The NM34C02 is capable of a sixteen byte page write operation. It is initiated in the same manner as the byte write operation; but

instead of terminating the write cycle after the first data byte is transferred, the master can transmit up to fifteen more bytes. After the receipt of each byte, the NM34C02 will respond with an acknowledge.

After the receipt of each byte, the internal address counter increments to the next address and the next SDA data is accepted. If the master should transmit more than sixteen bytes prior to generating the stop condition, the address counter will 'roll over' and the previously written data will be overwritten. As with the byte write operation, all inputs are disabled until completion of the internal write cycle. Refer to *Figure 6* for the address, acknowledge, and data transfer sequence.

Acknowledge Polling

Once the stop condition is issued to indicate the end of the host's write operation the NM34C02 initiates the internal write cycle. ACK polling can be initiated immediately. This involves issuing the start condition followed by the slave address for a write operation. If the NM34C02 is still busy with the write operation no ACK will be returned. If the NM34C02 has completed the write operation an ACK will be returned and the host can then proceed with the next read or write operation.

Software Write Protect

Write protection on the NM34C02 protects the first 128 bytes of the EEPROM memory. Write protection is implemented through a separate register called the WRITE PROTECT (WP) Register and writing to this WP register permanently WRITE protects the memory. **This WP register is a "one-time-only-write" register. Once this register is written, it cannot be erased. After the first WRITE to this register, all future access' to this register are ignored as if an invalid IIC cycle occurred.** To write protect, the user must perform a byte write to the WP register. This will permanently disable programming to the first 128 bytes of memory.

Addressing the WP Register

Addressing the WP register is very similar to accessing any memory array with the following difference:

Instead of the conventional "1010" IIC device address, the unused IIC device address "0110" is used to access just the WP register. Device address "1010" will be used for all the typical memory array access. With this difference in place, accessing the WP register is same as a typical IIC byte write cycle as described under "Write Operations" section. All timing information and waveform details remain the same. The "Byte Address" and the "Data" fields of the Byte write cycle serve as place holders and can be of any value (Don't Care). Refer to *Figure 7*.

Write Protect Scheme (Continued)

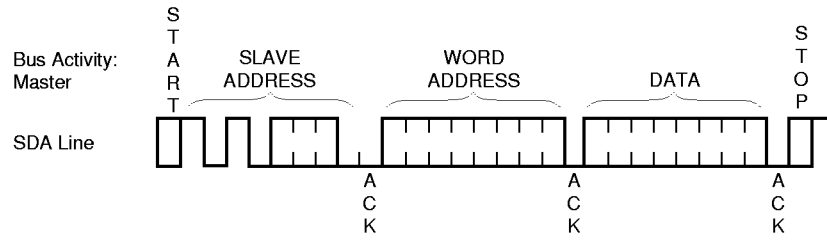

DS012821-14

Byte Write (Figure 5).

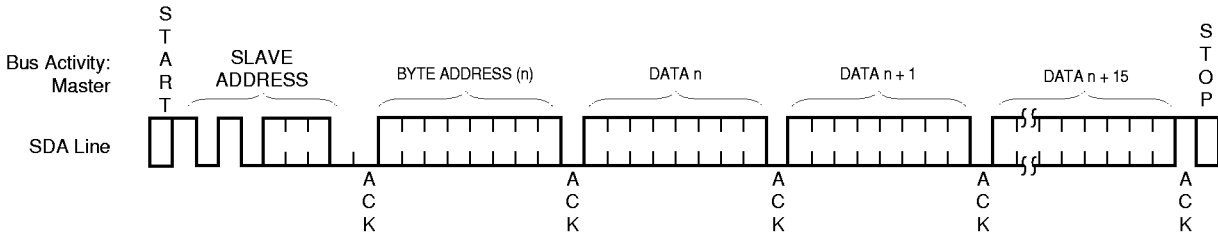

DS012821-15

Page Write (Figure 6).

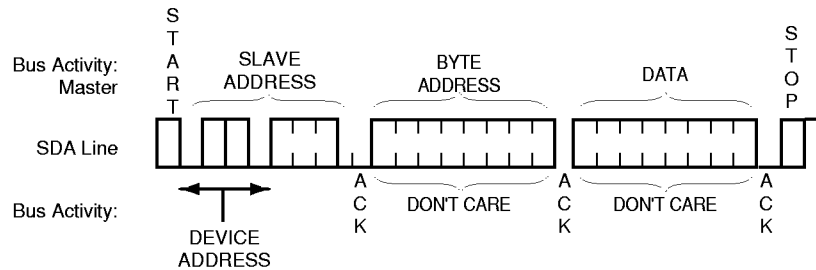

DS012821-16

WP Register Write (Figure 7).

Read Operations

Read operations are initiated in the same manner as write operations, with the exception that the R/W bit of the slave address is set to a one. There are three basic read operations: current address read, random read, and sequential read.

CURRENT ADDRESS READ

Internally the NM34C02 contains an address counter that maintains the address of the last word accessed, incremented by one. Therefore, if the last access (either a read or write) was to address n , the next read operation would access data from address $n + 1$. Upon receipt of the slave address with R/W set to one, the NM34C02 issues an acknowledge and transmits the data byte. The master will not acknowledge the transfer but does generate a stop condition, and therefore the NM34C02 discontinues transmission. Refer to Figure 8 for the sequence of address, acknowledge and data transfer.

RANDOM READ

Random read operations allow the master to access any memory location in a random manner. Prior to issuing the slave address with the R/W bit set to one, the master must first perform a "dummy" write operation. The master issues the start condition,

slave address, R/W bit set to zero, and then the word address to be read. After the Slave word address acknowledge, the master immediately reissues the start condition and the slave address with the R/W bit set to one. This will be followed by an acknowledge from the NM34C02 and then by the eight bit word. The master will not acknowledge the transfer but does generate the stop condition, and therefore the NM34C02 discontinues transmission. Refer to Figure 9 for the address, acknowledge and data transfer sequence.

SEQUENTIAL READ

Sequential reads can be initiated as either a current address read or random access read. The first word is transmitted in the same manner as the other read modes; however, the master now responds with an acknowledge, indicating it requires additional data. The NM34C02 continues to output data for each acknowledge received. The read operation is terminated by the master not responding with an acknowledge or by generating a stop condition.

The data output is sequential, with the data from address n followed by the data from $n + 1$. The address counter for read

Read Operations (Continued)

operations increments all word address bits, allowing the entire memory contents to be serially read during one operation. After the entire memory has been read, the counter 'rolls over' and the NM34C02 continues to output data for each acknowledge received. Refer to *Figure 10* for the address, acknowledge, and data transfer sequence.

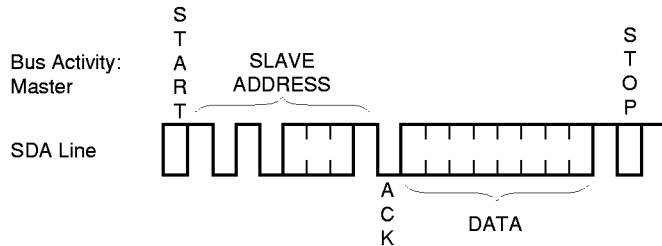

DS012821-17

Current Address Read (Figure 8).

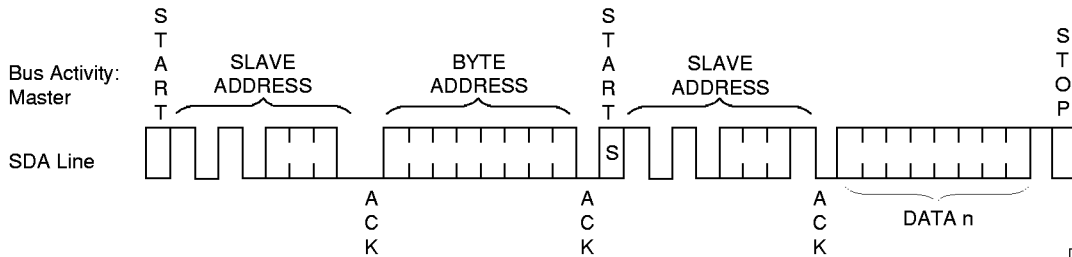

DS012821-18

Random Read (Figure 9).

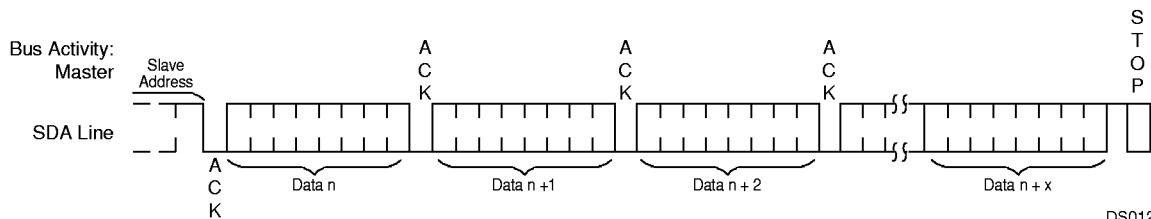

DS012821-19

Sequential Read (Figure 10).

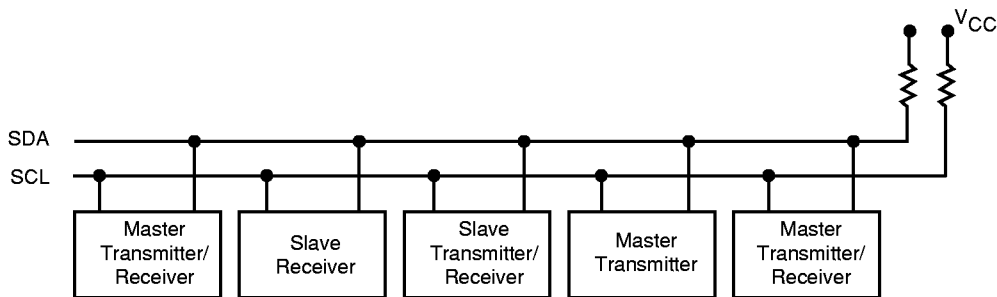

Note: Due to open drain configuration of SDA, a bus-level resistor is called for (Typical value = 4.7Ω)

DS012821-20

Typical System Configuration (Figure 11).

Physical Dimensions inches (millimeters) unless otherwise noted

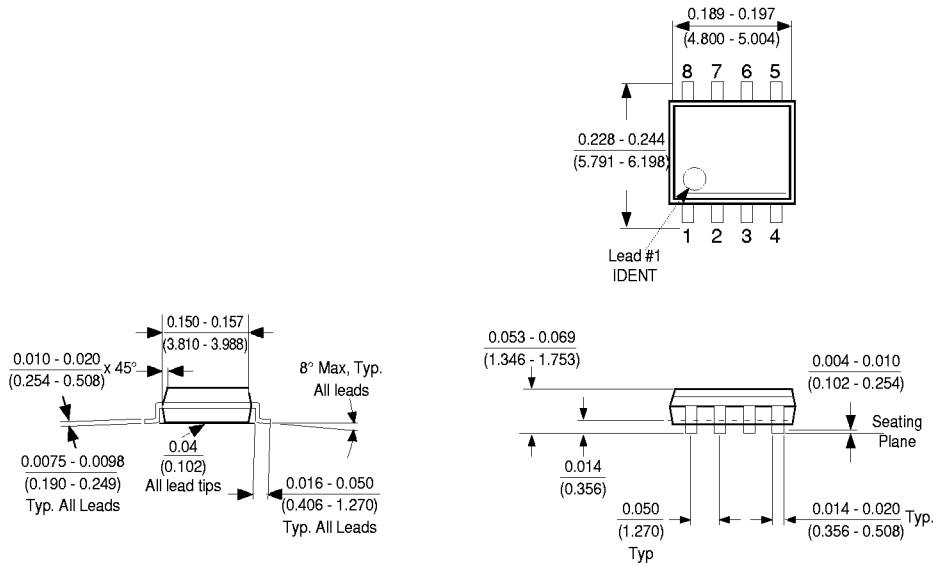

8-Pin Molded Small Outline Package (M8)
Order Number NM34C02LM8/LZM8
Package Number M08A

Physical Dimensions inches (millimeters) unless otherwise noted

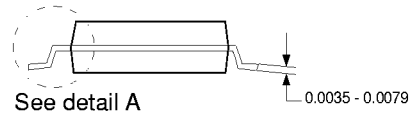
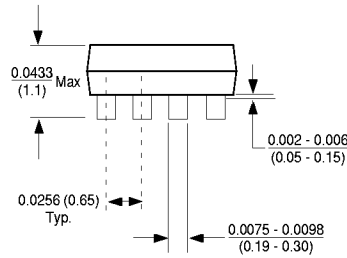
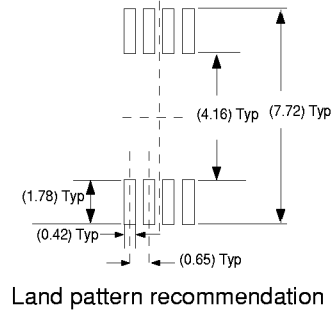
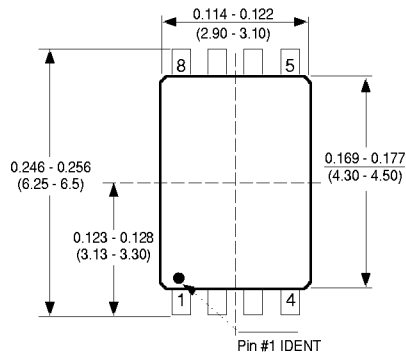

DETAIL A
Typ. Scale: 40X

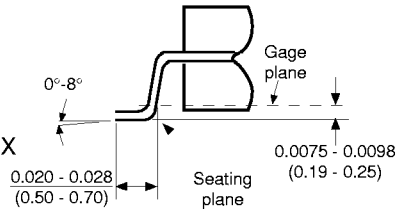

Notes: Unless otherwise specified

1. Reference JEDEC registration MO153. Variation AA. Dated 7/93

8-Pin Molded TSSOP, JEDEC (MT8)
Order Number NM34C02LMT8/LZMT8
Package Number MTC08

Life Support Policy

Fairchild's products are not authorized for use as critical components in life support devices or systems without the express written approval of the President of Fairchild Semiconductor Corporation. As used herein:

1. Life support devices or systems are devices or systems which, (a) are intended for surgical implant into the body, or (b) support or sustain life, and whose failure to perform, when properly used in accordance with instructions for use provided in the labeling, can be reasonably expected to result in a significant injury to the user.
2. A critical component is any component of a life support device or system whose failure to perform can be reasonably expected to cause the failure of the life support device or system, or to affect its safety or effectiveness.

Fairchild Semiconductor Americas Customer Response Center
Tel: 1-888-522-5372

Fairchild Semiconductor Europe
Fax: +44 (0) 1793-856858
Tel: +49 (0) 8141-6102-0
Deutsch Tel: +44 (0) 1793-856856
English Tel: +33 (0) 1-6930-3696
Français Tel: +39 (0) 2-249111-1
Italiano Tel: +39 (0) 2-249111-1

Fairchild Semiconductor Hong Kong
8/F, Room 808, Empire Centre
68 Mody Road, Tsimshatsui East
Kowloon, Hong Kong
Tel: +852-2722-8338
Fax: +852-2722-8383

Fairchild Semiconductor Japan Ltd.
4F, Natsume Bldg.
2-18-6, Yushima, Bunkyo-ku
Tokyo, 113-0034 Japan
Tel: 81-3-3818-8840
Fax: 81-3-3818-8841

Fairchild does not assume any responsibility for use of any circuitry described, no circuit patent licenses are implied and Fairchild reserves the right at any time without notice to change said circuitry and specifications.