

RP135

HIGH PERFORMANCE SINGLE STAGE POWER LINE FILTERS

FEATURES

- » Rated currents include **1A, 3A, 6A, 10 A, 16A, 20A, 30A, 60A, 100A, 150A, 180A and 200A**
- » Single Stage Line Filter
- » Available with **QD** tabs, **W** (wireleads), **S** (studs) and, **C** (connectors) option
- » High Performance
- » Agency Approved to UL1283/60929, CSA C22.2, EN 60939
- » Y-cap value can be adjusted to fit specifications



ELECTRICAL SCHEMATIC

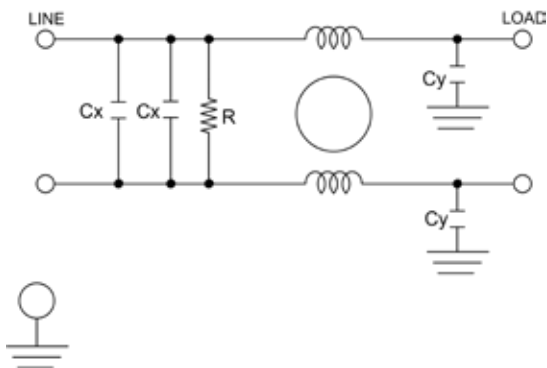

SPECIFICATIONS

OPERATING FREQUENCY	50/60Hz
USABLE FREQUENCY	DC - 400 Hz
MAX. OPERATING VOLTAGE	250V +10%
AMBIENT TEMPERATURE	-25 TO 40°C
CLIMATIC CATEGORY	25/100/21
TERMINALS (-T)	QD: 0.25" TABS (1A-20A) S: 30A(M4), 60-100A(M6), 150-200A (M10) W: WIRE LEADS C: CONNECTORS
TYP. WEIGHT, LBS (KG)	0.4 - 6 (0.2 - 2.72)

TYPICAL LEAKAGE CURRENT

@ 250 VAC 50 Hz	0 - 18.0 mA Max.
@ 120 VAC 60 Hz	0 - 9.0 mA Max.

HIPOT RATINGS

LINE TO GROUND	2700 VDC
----------------	----------

TYPICAL APPLICATIONS

- ✓ Household Appliances
- ✓ Industrial Equipment
- ✓ Medical Devices
- ✓ Communication systems
- ✓ Consumer Electronics
- ✓ Office Automation Devices
- ✓ Data Processing Systems

HOW TO ORDER

RP135- X - Y - Z

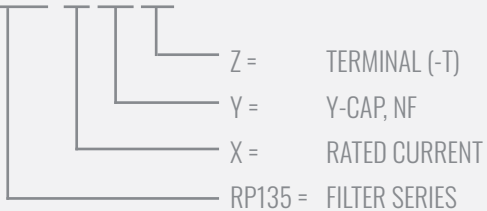

NOTE: USE ANY COMBINATION OF -X (AMPS) WITH ANY -Y RATINGS

E.G. **RP135-6-.47-QD** (6AMPS WITH .47 NF YCAP)

For **X, Y** and **Z** options see product specification table.

RP135

HIGH PERFORMANCE SINGLE STAGE POWER LINE FILTERS

MODEL NO.	RATED CURRENT, A @ 40° C	Y-CAP, nF	LEAKAGE CURRENT, mA @ 250V AC, 50 Hz / @ 120V AC, 60 Hz		TERMINAL OPTIONS				MAX. DIMENSIONS" (MM)		
					(QD) IN/ OUTPUT	(W) IN/ OUTPUT	(S) IN/ OUTPUT	(C) IN/ OUTPUT	WIDTH	(LENGTH)	HEIGHT
RP135-1-0-QD	1	0	-	-	✓				2.47" (62.7)	3.78" (96)	0.71" (18)
RP135-1-0-W	1	0	-	-		✓			2.47" (62.7)	2.18" (55.31)	0.71" (18)
RP135-1-47-QD	1	0.47	0.07	0.04	✓				2.47" (62.7)	3.78" (96)	0.71" (18)
RP135-1-47-W	1	0.47	0.07	0.04		✓			2.47" (62.7)	2.18" (55.31)	0.71" (18)
RP135-1-1-QD	1	1	0.15	0.09	✓				2.47" (62.7)	3.78" (96)	0.71" (18)
RP135-1-1-W	1	1	0.15	0.09		✓			2.47" (62.7)	2.18" (55.31)	0.71" (18)
RP135-1-2.2-QD	1	2.2	0.34	0.19	✓				2.47" (62.7)	3.78" (96)	0.71" (18)
RP135-1-2.2-W	1	2.2	0.34	0.19		✓			2.47" (62.7)	2.18" (55.31)	0.71" (18)
RP135-1-4.7-QD	1	4.7	0.73	0.42	✓				2.47" (62.7)	3.78" (96)	0.71" (18)
RP135-1-4.7-W	1	4.7	0.73	0.42		✓			2.47" (62.7)	2.18" (55.31)	0.71" (18)
RP135-1-10-QD	1	10	1.57	0.90	✓				2.47" (62.7)	3.78" (96)	0.71" (18)
RP135-1-10-W	1	10	1.57	0.90		✓			2.47" (62.7)	2.18" (55.31)	0.71" (18)
RP135-3-0-QD	3	0	-	-	✓				2.47" (62.7)	3.78" (96)	0.71" (18)
RP135-3-0-W	3	0	-	-		✓			2.47" (62.7)	2.18" (55.31)	0.71" (18)
RP135-3-47-QD	3	0.47	0.07	0.04	✓				2.47" (62.7)	3.78" (96)	0.71" (18)
RP135-3-47-S	3	0.47	0.07	0.04			✓		*	*	*
RP135-3-47-W	3	0.47	0.07	0.04		✓			2.47" (62.7)	2.18" (55.31)	0.71" (18)
RP135-3-1-QD	3	1	0.15	0.09	✓				2.47" (62.7)	3.78" (96)	0.71" (18)
RP135-3-1-W	3	1	0.15	0.09		✓			2.47" (62.7)	2.18" (55.31)	0.71" (18)
RP135-3-2.2-QD	3	2.2	0.34	0.19	✓				2.47" (62.7)	3.78" (96)	0.71" (18)
RP135-3-2.2-W	3	2.2	0.34	0.19		✓			2.47" (62.7)	2.18" (55.31)	0.71" (18)
RP135-3-4.7-QD	3	4.7	0.73	0.42	✓				2.47" (62.7)	3.78" (96)	0.71" (18)
RP135-3-4.7-W	3	4.7	0.73	0.42		✓			2.47" (62.7)	2.18" (55.31)	0.71" (18)
RP135-3-10-QD	3	10	1.57	0.90	✓				2.47" (62.7)	3.78" (96)	0.71" (18)
RP135-3-10-W	3	10	1.57	0.90		✓			2.47" (62.7)	2.18" (55.31)	0.71" (18)
RP135-6-0-QD	6	0	-	-	✓				2.47" (62.7)	3.78" (96)	0.71" (18)
RP135-6-0-W	6	0	-	-		✓			2.47" (62.7)	2.18" (55.31)	0.71" (18)
RP135-6-47-QD	6	0.47	0.07	0.04	✓				2.47" (62.7)	3.78" (96)	0.71" (18)
RP135-6-47-W	6	0.47	0.07	0.04		✓			2.47" (62.7)	2.18" (55.31)	0.71" (18)
RP135-6-1-QD	6	1	0.15	0.09	✓				2.47" (62.7)	3.78" (96)	0.71" (18)
RP135-6-1-W	6	1	0.15	0.09		✓			2.47" (62.7)	2.18" (55.31)	0.71" (18)
RP135-6-2.2-QD	6	2.2	0.34	0.19	✓				2.47" (62.7)	3.78" (96)	0.71" (18)
RP135-6-2.2-W	6	2.2	0.34	0.19		✓			2.47" (62.7)	2.18" (55.31)	0.71" (18)
RP135-6-4.7-QD	6	4.7	0.73	0.42	✓				2.47" (62.7)	3.78" (96)	0.71" (18)

ADDITIONAL MODEL NO. >>

RP135

HIGH PERFORMANCE SINGLE STAGE POWER LINE FILTERS

MODEL NO.	RATED CURRENT, A @ 40° C	Y-CAP, nF	LEAKAGE CURRENT, mA @ 250V AC, 50 Hz / @ 120V AC, 60 Hz		TERMINAL OPTIONS				MAX. DIMENSIONS" (MM)		
					(QD)IN/ OUTPUT	(W) IN/ OUTPUT	(S) IN/ OUTPUT	(C) IN/ OUTPUT	WIDTH	(LENGTH)	HEIGHT
RP135-6-4.7-W	6	4.7	0.73	0.42		✓			2.47"(62.7)	2.18"(55.31)	0.71"(18)
RP135-6-10-QD	6	10	1.57	0.90	✓				2.47"(62.7)	3.78"(96)	0.71"(18)
RP135-6-10-W	6	10	1.57	0.90		✓			2.47"(62.7)	2.18"(55.31)	0.71"(18)
RP135-10-0-QD	10	0	-	-	✓				2.47"(62.7)	3.78"(96)	0.71"(18)
RP135-10-0-W	10	0	-	-		✓			2.47"(62.7)	2.18"(55.31)	0.71"(18)
RP135-10-.47-QD	10	0.47	0.07	0.04	✓				2.47"(62.7)	3.78"(96)	0.71"(18)
RP135-10-.47-W	10	0.47	0.07	0.04		✓			2.47"(62.7)	2.18"(55.31)	0.71"(18)
RP135-10-1-QD	10	1	0.15	0.09	✓				2.47"(62.7)	3.78"(96)	0.71"(18)
RP135-10-1-W	10	1	0.15	0.09		✓			2.47"(62.7)	2.18"(55.31)	0.71"(18)
RP135-10-2.2-QD	10	2.2	0.34	0.19	✓				2.47"(62.7)	3.78"(96)	0.71"(18)
RP135-10-2.2-W	10	2.2	0.34	0.19		✓			2.47"(62.7)	2.18"(55.31)	0.71"(18)
RP135-10-4.7-QD	10	4.7	0.73	0.42	✓				2.47"(62.7)	3.78"(96)	0.71"(18)
RP135-10-4.7-W	10	4.7	0.73	0.42		✓			2.47"(62.7)	2.18"(55.31)	0.71"(18)
RP135-10-10-QD	10	10	1.57	0.90	✓				2.47"(62.7)	3.78"(96)	0.71"(18)
RP135-10-10-W	10	10	1.57	0.90		✓			2.47"(62.7)	2.18"(55.31)	0.71"(18)
RP135-16-0-QD	16	0	-	-	✓				1.85"(47)	2.93"(74.4)	1.18"(30)
RP135-16-0-W	16	0	-	-		✓			1.85"(47)	2.80"(71)	1.18"(30)
RP135-16-.47-QD	16	0.47	0.73	0.42	✓				1.85"(47)	2.93"(74.4)	1.18"(30)
RP135-16-.47-W	16	0.47	0.73	0.42		✓			1.85"(47)	2.80"(71)	1.18"(30)
RP135-16-1-QD	16	1	0.15	0.09	✓				1.85"(47)	2.93"(74.4)	1.18"(30)
RP135-16-1-W	16	1	0.15	0.09		✓			1.85"(47)	2.80"(71)	1.18"(30)
RP135-16-2.2-QD	16	2.2	0.34	0.19	✓				1.85"(47)	2.93"(74.4)	1.18"(30)
RP135-16-2.2-W	16	2.2	0.34	0.19		✓			1.85"(47)	2.80"(71)	1.18"(30)
RP135-16-4.7-QD	16	4.7	0.73	0.42	✓				1.85"(47)	2.93"(74.4)	1.18"(30)
RP135-16-4.7-W	16	4.7	0.73	0.42		✓			1.85"(47)	2.80"(71)	1.18"(30)
RP135-16-10-QD	16	10	1.57	0.90	✓				1.85"(47)	2.93"(74.4)	1.18"(30)
RP135-16-10-W	16	10	1.57	0.90		✓			1.85"(47)	2.80"(71)	1.18"(30)
RP135-20-0-QD	20	0	-	-	✓				1.85"(47)	2.93"(74.4)	1.18"(30)
RP135-20-0-S	20	0	-	-			✓		2.04"(52)	3.90"(99)	1.61"(41)
RP135-20-0-W	20	0	-	-		✓			2.04"(52)	3.35"(85)	1.61"(41)
RP135-20-.47-QD	20	0.47	0.73	0.42	✓				2.04"(52)	3.45"(87.72)	1.61"(41)
RP135-20-.47-S	20	0.47	0.73	0.42			✓		2.04"(52)	3.90"(99)	1.61"(41)
RP135-20-.47-W	20	0.47	0.73	0.42		✓			2.04"(52)	3.35"(85)	1.61"(41)
RP135-20-1-QD	20	1	0.15	0.09	✓				2.04"(52)	3.45"(87.72)	1.61"(41)

ADDITIONAL MODEL NO. >>

RP135

HIGH PERFORMANCE SINGLE STAGE POWER LINE FILTERS

MODEL NO.	RATED CURRENT, A @ 40° C	Y-CAP, nF	LEAKAGE CURRENT, mA @ 250V AC, 50 Hz / @ 120V AC, 60 Hz		TERMINAL OPTIONS				MAX. DIMENSIONS" (MM)		
					(QD)IN/ OUTPUT	(W) IN/ OUTPUT	(S) IN/ OUTPUT	(C) IN/ OUTPUT	WIDTH	(LENGTH)	HEIGHT
RP135-20-1-S	20	1	0.15	0.09			✓		2.04" (52)	3.90" (99)	1.61" (41)
RP135-20-1-W	20	1	0.15	0.09		✓			2.04" (52)	3.35" (85)	1.61" (41)
RP135-20-2.2-QD	20	2.2	0.34	0.19	✓				2.04" (52)	3.45" (87.72)	1.61" (41)
RP135-20-2.2-S	20	2.2	0.34	0.19			✓		2.04" (52)	3.90" (99)	1.61" (41)
RP135-20-2.2-W	20	2.2	0.34	0.19		✓			2.04" (52)	3.35" (85)	1.61" (41)
RP135-20-4.7-QD	20	4.7	0.73	0.42	✓				2.04" (52)	3.45" (87.72)	1.61" (41)
RP135-20-4.7-S	20	4.7	0.73	0.42			✓		2.04" (52)	3.90" (99)	1.61" (41)
RP135-20-4.7-W	20	4.7	0.73	0.42		✓			2.04" (52)	3.35" (85)	1.61" (41)
RP135-20-10-QD	20	10	1.57	0.90	✓				2.04" (52)	3.45" (87.72)	1.61" (41)
RP135-20-10-S	20	10	1.57	0.90			✓		2.04" (52)	3.90" (99)	1.61" (41)
RP135-20-10-W	20	10	1.57	0.90		✓			2.04" (52)	3.35" (85)	1.61" (41)
RP135-30-0-C	30	0	-	-				✓	*	*	*
RP135-30-0-S	30	0	-	-			✓		2.76" (70)	3.35" (85)	1.14" (29)
RP135-30-0-W	30	0	-	-		✓			*	*	*
RP135-30-47-C	30	0.47	0.73	0.42				✓	*	*	*
RP135-30-47-S	30	0.47	0.73	0.42			✓		2.76" (70)	3.35" (85)	1.14" (29)
RP135-30-47-W	30	0.47	0.73	0.42		✓			*	*	*
RP135-30-1-C	30	1	0.15	0.09				✓	*	*	*
RP135-30-1-S	30	1	0.15	0.09			✓		2.76" (70)	3.35" (85)	1.14" (29)
RP135-30-1-W	30	1	0.15	0.09		✓			*	*	*
RP135-30-2.2-C	30	2.2	0.34	0.19				✓	*	*	*
RP135-30-2.2-S	30	2.2	0.34	0.19			✓		2.76" (70)	3.35" (85)	1.14" (29)
RP135-30-2.2-W	30	2.2	0.34	0.19		✓			*	*	*
RP135-30-4.7-C	30	4.7	0.73	0.42				✓	*	*	*
RP135-30-4.7-S	30	4.7	0.73	0.42			✓		2.76" (70)	3.35" (85)	1.14" (29)
RP135-30-4.7-W	30	4.7	0.73	0.42		✓			*	*	*
RP135-30-10-C	30	10	1.57	0.90				✓	*	*	*
RP135-30-10-S	30	10	1.57	0.90			✓		2.76" (70)	3.35" (85)	1.14" (29)
RP135-30-10-W	30	10	1.57	0.90		✓			*	*	*
RP135-60-0-C	60	0	-	-				✓	*	*	*
RP135-60-0-S	60	0	-	-			✓		4.25" (108)	5.87" (149)	2.24" (57)
RP135-60-0-W	60	0	-	-		✓			*	*	*
RP135-60-47-C	60	0.47	0.73	0.42				✓	*	*	*
RP135-60-47-S	60	0.47	0.73	0.42			✓		4.25" (108)	5.87" (149)	2.24" (57)

ADDITIONAL MODEL NO. >>

RP135

HIGH PERFORMANCE SINGLE STAGE POWER LINE FILTERS

MODEL NO.	RATED CURRENT, A @ 40° C	Y-CAP, nF	LEAKAGE CURRENT, mA @ 250V AC, 50 Hz / @ 120V AC, 60 Hz		TERMINAL OPTIONS				MAX. DIMENSIONS" (MM)		
					(QD)IN/ OUTPUT	(W) IN/ OUTPUT	(S) IN/ OUTPUT	(C) IN/ OUTPUT	WIDTH	(LENGTH)	HEIGHT
RP135-60-47-W	60	0.47	0.73	0.42		✓			*	*	*
RP135-60-1-C	60	1	0.15	0.09				✓	*	*	*
RP135-60-1-S	60	1	0.15	0.09			✓		4.25" (108)	5.87" (149)	2.24" (57)
RP135-60-1-W	60	1	0.15	0.09		✓			*	*	*
RP135-60-2.2-C	60	2.2	0.34	0.19				✓	*	*	*
RP135-60-2.2-S	60	2.2	0.34	0.19			✓		4.25" (108)	5.87" (149)	2.24" (57)
RP135-60-2.2-W	60	2.2	0.34	0.19		✓			*	*	*
RP135-60-4.7-C	60	4.7	0.73	0.42				✓	*	*	*
RP135-60-4.7-S	60	4.7	0.73	0.42			✓		4.25" (108)	5.87" (149)	2.24" (57)
RP135-60-4.7-W	60	4.7	0.73	0.42		✓			*	*	*
RP135-60-10-C	60	10	1.57	0.90				✓	*	*	*
RP135-60-10-S	60	10	1.57	0.90			✓		4.25" (108)	5.87" (149)	2.24" (57)
RP135-60-10-W	60	10	1.57	0.90		✓			*	*	*
RP135-60-22-C	60	22	3.45	1.99				✓	*	*	*
RP135-60-22-S	60	22	3.45	1.99			✓		4.25" (108)	5.87" (149)	2.24" (57)
RP135-60-22-W	60	22	3.45	1.99		✓			*	*	*
RP135-60-100-C	60	100	15.70	9.04				✓	*	*	*
RP135-60-100-S	60	100	15.70	9.04			✓		4.25" (108)	5.87" (149)	2.24" (57)
RP135-60-100-W	60	100	15.70	9.04		✓			*	*	*
RP135-100-0-C	100	0	-	-				✓	*	*	*
RP135-100-0-S	100	0	-	-			✓		4.25" (108)	9.74" (247.4)	2.75" (69.9)
RP135-100-0-W	100	0	-	-		✓			*	*	*
RP135-100-47-C	100	0.47	0.73	0.42				✓	*	*	*
RP135-100-47-S	100	0.47	0.73	0.42			✓		4.25" (108)	9.74" (247.4)	2.75" (69.9)
RP135-100-47-W	100	0.47	0.73	0.42		✓			*	*	*
RP135-100-1-C	100	1	0.15	0.09				✓	*	*	*
RP135-100-1-S	100	1	0.15	0.09			✓		4.25" (108)	9.74" (247.4)	2.75" (69.9)
RP135-100-1-W	100	1	0.15	0.09		✓			*	*	*
RP135-100-2.2-C	100	2.2	0.34	0.19				✓	*	*	*
RP135-100-2.2-S	100	2.2	0.34	0.19			✓		4.25" (108)	9.74" (247.4)	2.75" (69.9)
RP135-100-2.2-W	100	2.2	0.34	0.19		✓			*	*	*
RP135-100-4.7-C	100	4.7	0.73	0.42				✓	*	*	*
RP135-100-4.7-S	100	4.7	0.73	0.42			✓		4.25" (108)	9.74" (247.4)	2.75" (69.9)
RP135-100-4.7-W	100	4.7	0.73	0.42		✓			*	*	*

ADDITIONAL MODEL NO. >>

RP135

HIGH PERFORMANCE SINGLE STAGE POWER LINE FILTERS

MODEL NO.	RATED CURRENT, A @ 40° C	Y-CAP, nF	LEAKAGE CURRENT, mA @ 250V AC, 50 Hz / @ 120V AC, 60 Hz		TERMINAL OPTIONS				MAX. DIMENSIONS" (MM)		
					(QD)IN/ OUTPUT	(W) IN/ OUTPUT	(S) IN/ OUTPUT	(C) IN/ OUTPUT	WIDTH	(LENGTH)	HEIGHT
RP135-100-10-C	100	10	1.57	0.90				✓	*	*	*
RP135-100-10-S	100	10	1.57	0.90			✓		4.25" (108)	9.74" (247.4)	2.75" (69.9)
RP135-100-10-W	100	10	1.57	0.90		✓			*	*	*
RP135-100-22-C	100	22	3.45	1.99				✓	*	*	*
RP135-100-22-S	100	22	3.45	1.99			✓		4.25" (108)	9.74" (247.4)	2.75" (69.9)
RP135-100-22-W	100	22	3.45	1.99		✓			*	*	*
RP135-100-100-C	100	100	15.70	9.04				✓	*	*	*
RP135-100-100-S	100	100	15.70	9.04			✓		4.25" (108)	9.74" (247.4)	2.75" (69.9)
RP135-100-100-W	100	100	15.70	9.04		✓			*	*	*
RP135-150-0-C	150	0	-	-				✓	*	*	*
RP135-150-0-S	150	0	-	-			✓		4.25" (108)	9.74" (247.4)	2.75" (69.9)
RP135-150-0-W	150	0	-	-		✓			*	*	*
RP135-150-47-C	150	0.47	0.73	0.42				✓	*	*	*
RP135-150-47-S	150	0.47	0.73	0.42			✓		4.25" (108)	9.74" (247.4)	2.75" (69.9)
RP135-150-47-W	150	0.47	0.73	0.42		✓			*	*	*
RP135-150-1-C	150	1	0.15	0.09				✓	*	*	*
RP135-150-1-S	150	1	0.15	0.09			✓		4.25" (108)	9.74" (247.4)	2.75" (69.9)
RP135-150-1-W	150	1	0.15	0.09		✓			*	*	*
RP135-150-2.2-C	150	2.2	0.34	0.19				✓	*	*	*
RP135-150-2.2-S	150	2.2	0.34	0.19			✓		4.25" (108)	9.74" (247.4)	2.75" (69.9)
RP135-150-2.2-W	150	2.2	0.34	0.19		✓			*	*	*
RP135-150-4.7-C	150	4.7	0.73	0.42				✓	*	*	*
RP135-150-4.7-S	150	4.7	0.73	0.42			✓		4.25" (108)	9.74" (247.4)	2.75" (69.9)
RP135-150-4.7-W	150	4.7	0.73	0.42		✓			*	*	*
RP135-150-10-C	150	10	1.57	0.90				✓	*	*	*
RP135-150-10-S	150	10	1.57	0.90			✓		4.25" (108)	9.74" (247.4)	2.75" (69.9)
RP135-150-10-W	150	10	1.57	0.90		✓			*	*	*
RP135-150-22-C	150	22	3.45	1.99				✓	*	*	*
RP135-150-22-S	150	22	3.45	1.99			✓		4.25" (108)	9.74" (247.4)	2.75" (69.9)
RP135-150-22-W	150	22	3.45	1.99		✓			*	*	*
RP135-150-100-C	150	100	15.70	9.04				✓	*	*	*
RP135-150-100-S	150	100	15.70	9.04			✓		4.25" (108)	9.74" (247.4)	2.75" (69.9)
RP135-150-100-W	150	100	15.70	9.04		✓			*	*	*
RP135-180-0-C	180	0	-	-				✓	*	*	*

ADDITIONAL MODEL NO. >>

RP135

HIGH PERFORMANCE SINGLE STAGE POWER LINE FILTERS

MODEL NO.	RATED CURRENT, A @ 40° C	Y-CAP, nF	LEAKAGE CURRENT, mA @ 250V AC, 50 Hz / @ 120V AC, 60 Hz		TERMINAL OPTIONS				MAX. DIMENSIONS" (MM)		
					(QD) IN/ OUTPUT	(W) IN/ OUTPUT	(S) IN/ OUTPUT	(C) IN/ OUTPUT	WIDTH	(LENGTH)	HEIGHT
RP135-180-0-S	180	0	-	-			✓		4.25" (108)	9.74" (247.4)	2.75" (69.9)
RP135-180-0-W	180	0	-	-	✓				*	*	*
RP135-180-47-C	180	0.47	0.73	0.42			✓		*	*	*
RP135-180-47-S	180	0.47	0.73	0.42			✓		4.25" (108)	9.74" (247.4)	2.75" (69.9)
RP135-180-47-W	180	0.47	0.73	0.42	✓				*	*	*
RP135-180-1-C	180	1	0.15	0.09			✓		*	*	*
RP135-180-1-S	180	1	0.15	0.09			✓		4.25" (108)	9.74" (247.4)	2.75" (69.9)
RP135-180-1-W	180	1	0.15	0.09	✓				*	*	*
RP135-180-2.2-C	180	2.2	0.34	0.19			✓		*	*	*
RP135-180-2.2-S	180	2.2	0.34	0.19			✓		4.25" (108)	9.74" (247.4)	2.75" (69.9)
RP135-180-2.2-W	180	2.2	0.34	0.19	✓				*	*	*
RP135-180-4.7-C	180	4.7	0.73	0.42			✓		*	*	*
RP135-180-4.7-S	180	4.7	0.73	0.42			✓		4.25" (108)	9.74" (247.4)	2.75" (69.9)
RP135-180-4.7-W	180	4.7	0.73	0.42	✓				*	*	*
RP135-180-10-C	180	10	1.57	0.90			✓		*	*	*
RP135-180-10-S	180	10	1.57	0.90			✓		4.25" (108)	9.74" (247.4)	2.75" (69.9)
RP135-180-10-W	180	10	1.57	0.90	✓				*	*	*
RP135-180-22-C	180	22	3.45	1.99			✓		*	*	*
RP135-180-22-S	180	22	3.45	1.99			✓		4.25" (108)	9.74" (247.4)	2.75" (69.9)
RP135-180-22-W	180	22	3.45	1.99	✓				*	*	*
RP135-180-100-C	180	100	15.70	9.04			✓		*	*	*
RP135-180-100-S	180	100	15.70	9.04			✓		4.25" (108)	9.74" (247.4)	2.75" (69.9)
RP135-180-100-W	180	100	15.70	9.04	✓				*	*	*
RP135-200-0-C	200	0	-	-			✓		*	*	*
RP135-200-0-S	200	0	-	-			✓		4.25" (108)	9.74" (247.4)	2.75" (69.9)
RP135-200-0-W	200	0	-	-	✓				*	*	*
RP135-200-47-C	200	0.47	0.73	0.42			✓		*	*	*
RP135-200-47-S	200	0.47	0.73	0.42			✓		4.25" (108)	9.74" (247.4)	2.75" (69.9)
RP135-200-47-W	200	0.47	0.73	0.42	✓				*	*	*
RP135-200-1-C	200	1	0.15	0.09			✓		*	*	*
RP135-200-1-S	200	1	0.15	0.09			✓		4.25" (108)	9.74" (247.4)	2.75" (69.9)
RP135-200-1-W	200	1	0.15	0.09	✓				*	*	*
RP135-200-2.2-C	200	2.2	0.34	0.19			✓		*	*	*
RP135-200-2.2-S	200	2.2	0.34	0.19			✓		4.25" (108)	9.74" (247.4)	2.75" (69.9)

ADDITIONAL MODEL NO. >>

RP135

HIGH PERFORMANCE SINGLE STAGE POWER LINE FILTERS

MODEL NO.	RATED CURRENT, A @ 40° C	Y-CAP, nF	LEAKAGE CURRENT, mA @ 250V AC, 50 Hz / @ 120V AC, 60 Hz		TERMINAL OPTIONS				MAX. DIMENSIONS" (MM)		
					(QD)IN/ OUTPUT	(W) IN/ OUTPUT	(S) IN/ OUTPUT	(C) IN/ OUTPUT	WIDTH	(LENGTH)	HEIGHT
RP135-200-2.2-W	200	2.2	0.34	0.19		✓			*	*	*
RP135-200-4.7-C	200	4.7	0.73	0.42				✓	*	*	*
RP135-200-4.7-S	200	4.7	0.73	0.42			✓		4.25" (108)	9.74" (247.4)	2.75" (69.9)
RP135-200-4.7-W	200	4.7	0.73	0.42		✓			*	*	*
RP135-200-10-C	200	10	1.57	0.90				✓	*	*	*
RP135-200-10-S	200	10	1.57	0.90			✓		4.25" (108)	9.74" (247.4)	2.75" (69.9)
RP135-200-10-W	200	10	1.57	0.90		✓			*	*	*
RP135-200-22-C	200	22	3.45	1.99				✓	*	*	*
RP135-200-22-S	200	22	3.45	1.99			✓		4.25" (108)	9.74" (247.4)	2.75" (69.9)
RP135-200-22-W	200	22	3.45	1.99		✓			*	*	*
RP135-200-100-C	200	100	15.70	9.04				✓	*	*	*
RP135-200-100-S	200	100	15.70	9.04			✓		4.25" (108)	9.74" (247.4)	2.75" (69.9)
RP135-200-100-W	200	100	15.70	9.04		✓			*	*	*

*Contact factory for dimensions.

RP135 MECHANICAL OUTLINES (MM)

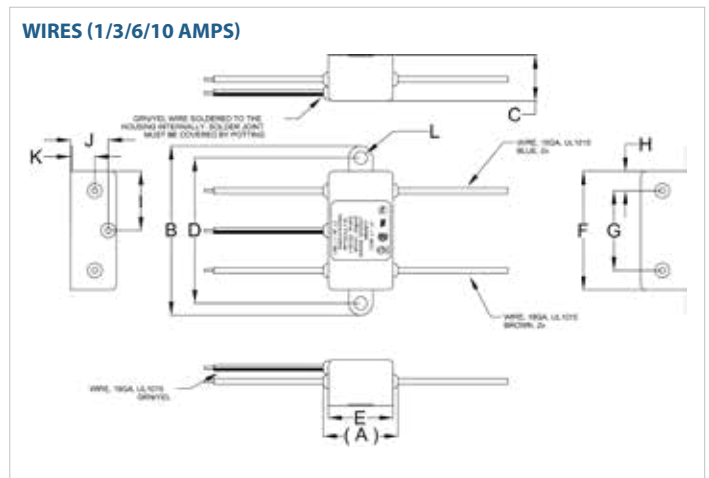
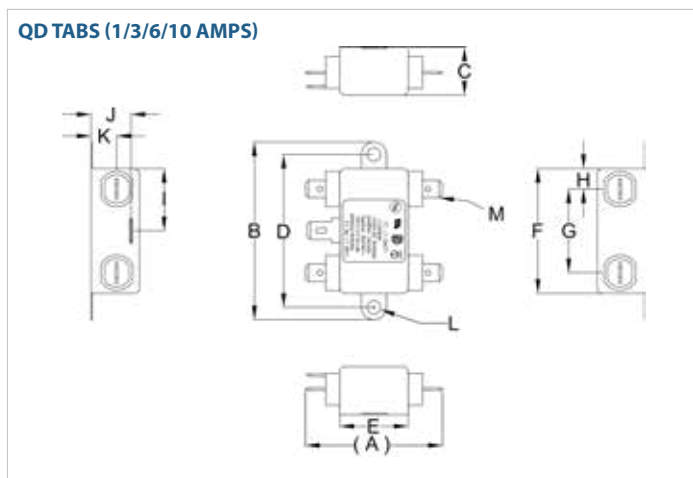

ADDITIONAL MODEL NO. >>

RP135

HIGH PERFORMANCE SINGLE STAGE POWER LINE FILTERS

QD TABS (16/20 AMPS)

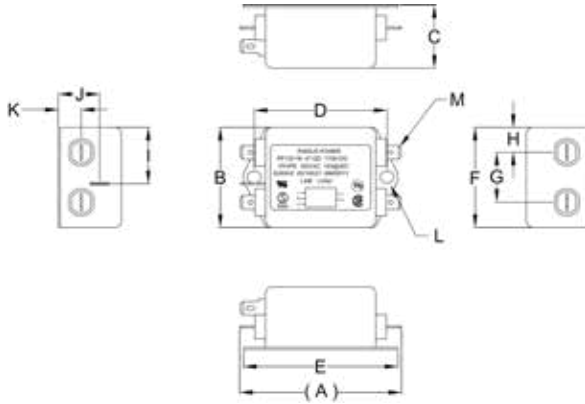

WIRES (16/20 AMPS)

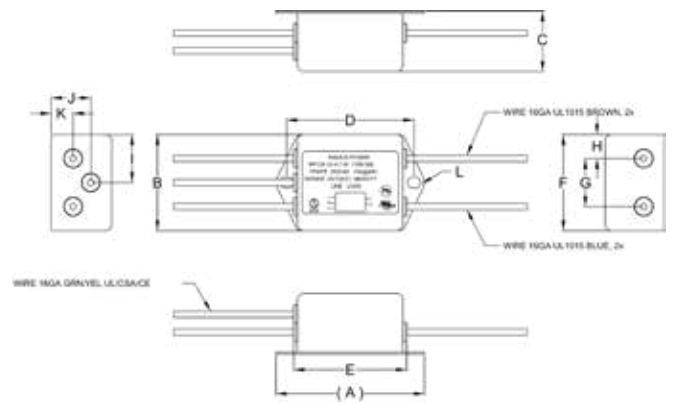

STUDS (20 AMPS)

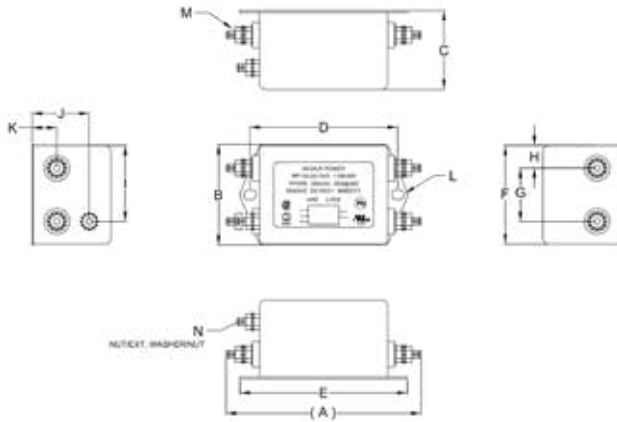

STUDS (30 AMPS)

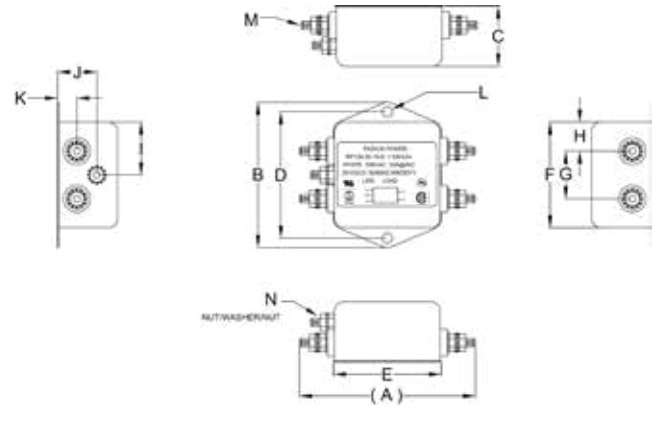

STUDS (60 AMPS)

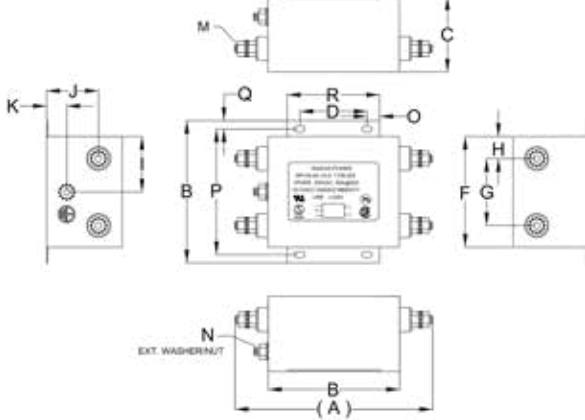

STUDS (100/150/200 AMPS)

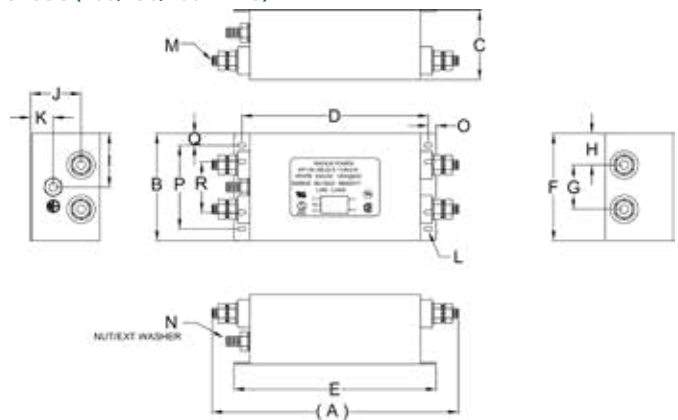

RP135

HIGH PERFORMANCE SINGLE STAGE POWER LINE FILTERS

SERIES	(A)	B	C	D	E	F	G	H	I	J	K	L	M	N	O	P	Q	R
QD TABS (3/6/10A)	3.78" (96)	2.47" (62.7)	0.71" (18)	2.33" (59.3)	0.98" (25)	1.77" (45)	1.16" (29.5)	0.29" (7.25)	0.87" (22)	0.55" (14)	0.35" (9)	Ø0.18",2x Ø4.8, 2x	0.25", 5x QD, MALE, 6.35, 5x	N/A	N/A	N/A	N/A	N/A
WIRES (3/6/10A)	2.18" (55.31)	2.47" (62.70)	0.71" (18)	2.33" (59.30)	0.98" (25)	1.77" (45)	1.16" (29.5)	0.29" (7.3)	0.87" (22)	0.55" (14)	0.35" (9)	Ø0.18",2x Ø4.8, 2x	N/A	N/A	N/A	N/A	N/A	N/A
QD TABS (16A)	2.93" (74.4)	1.85" (47)	1.18" (30)	2.40" (61)	2.80" (71)	1.85" (47)	0.91" (23)	0.45" (11.5)	1.02" (26)	0.75" (19)	0.41" (10.5)	Ø0.24"x5.3,2x Ø6.3x5.3, 2x	0.25", 5x QD, MALE, 6.35, 5x	N/A	N/A	N/A	N/A	N/A
WIRES (16A)	2.80" (71)	1.85" (47)	1.18" (30)	2.40" (61)	2.13 54.06	1.85" (47)	0.91 23.00	0.45" (11.5)	0.91" (23)	0.75" (19)	0.41" (10.5)	Ø0.24"x5.3,2x Ø6.3x5.3, 2x	N/A	N/A	N/A	N/A	N/A	N/A
QD TABS (20A)	3.45" (87.72)	2.04" (52)	1.61" (41)	2.95" (75)	3.35 85.00	2.01" (51)	1.06" (7)	0.45" (11.5)	1.52" (38.5)	1.14" (29)	0.49" (12.5)	Ø0.25"x5.3,2x Ø6.4x5.3, 2x	0.25", 5x QD, MALE, 6.35, 5x	N/A	N/A	N/A	N/A	N/A
WIRES (20A)	3.35" (85)	2.04" (52)	1.61" (41)	2.95" (75)	2.60" (66)	2.01" (51)	1.06" (27)	0.45" (11.5)	1.52" (38.5)	1.14" (29)	0.49" (12.5)	Ø0.25"x5.3,2x Ø6.4x5.3, 2x	N/A	N/A	N/A	N/A	N/A	N/A
STUDS (20A)	3.90" (99)	2.04" (52)	1.61" (41)	2.95" (75)	3.35" (85)	2.01" (51)	1.06" (27)	0.45" (11.5)	1.52" (38.5)	1.14" (29)	1.06" (27)	Ø0.25"x5.3,2x Ø6.4x5.3, 2x	STUD, M4, 4x	STUD, GND, M4	N/A	N/A	N/A	N/A
STUDS (30A)	3.35" (85)	2.76" (70)	1.14" (29)	2.40" (61)	2.08" (53)	2.04" (52)	0.91" (23)	0.55" (14)	1.00" (25.5)	0.75" (19)	0.37" (9.3)	Ø0.19", 2x Ø5.0, 2x	N/A	STUD, GND, M4	N/A	N/A	N/A	N/A
STUDS (60A)	5.87" (149)	4.25" (108)	2.24" (57)	2.00" (50.8)	3.90" (99.1)	3.30" (83.8)	2.00" (50.8)	0.66" (16.7)	1.66" (42.1)	1.54" (39.2)	0.60" (15.2)	N/A	STUD, M6, 4x	STUD, GND, M6	0.38" (9.53)	3.75" (95.25)	0.25" (6.35)	2.75" (69.9)
STUDS (100/150 /200A)	9.74" (247.4)	4.25" (108)	2.75" (69.9)	7.37" (187)	8.00" (203.2)	4.25" (108)	1.75" (44.5)	1.25" (31.8)	2.13" (54)	2.00" (50.8)	0.90" (22.9)	Ø0.29"x4.6, 8x Ø7.6x4.6, 8x	STUD, M10, 4x	STUD, GND, M10	0.31" (7.9)	3.31" (84)	0.47" (12)	2.00" (50.8)

TYPICAL TOLERANCE: +/-0.50MM (0.02")

TYPICAL INSERTION LOSS, dB (50/50 Ohm)

Amps	Freq (MHz)	Insertion Loss (dB)					
		0.15	0.5	1.0	10	30	
1	CM (dB)	40	50	50	45	40	
	DM (dB)	15	26	45	50	50	
3	CM (dB)	30	42	50	55	35	
	DM (dB)	18	30	40	55	50	
6	CM (dB)	20	30	36	55	40	
	DM (dB)	15	26	32	55	40	
10	CM (dB)	18	25	40	55	45	
	DM (dB)	15	25	40	65	50	
16	CM (dB)	18	25	40	55	45	
	DM (dB)	15	25	40	65	50	

RP135

HIGH PERFORMANCE SINGLE STAGE POWER LINE FILTERS

Amps	Freq (MHz)	0.15	0.5	1.0	10	30
20	CM (dB)	24	38	45	50	50
	DM (dB)	42	60	65	60	50
30	CM (dB)	20	30	40	45	50
	DM (dB)	38	70	70	55	60
60	CM (dB)	20	30	40	45	50
	DM (dB)	38	70	70	55	60
100	CM (dB)	20	30	40	45	50
	DM (dB)	40	60	65	70	65
150	CM (dB)	20	30	40	45	50
	DM (dB)	40	60	65	70	65
180	CM (dB)	20	30	40	45	50
	DM (dB)	40	60	65	70	65
200	CM (dB)	20	30	40	45	50
	DM (dB)	40	60	65	70	65