



MPQ7200A

42V, 1.2A Buck-Boost or 3A Buck,
410kHz with FSS, Synchronous LED Driver,
AEC-Q100 Qualified

DESCRIPTION

The MPQ7200A is a fixed-frequency, constant current buck-boost LED driver with integrated power MOSFETs. It offers a very compact solution to achieve 1.2A of continuous output current (I_{OUT}), with excellent load and line regulation across a wide input supply range. The MPQ7200A can also be configured for buck mode to provide up to 3A of continuous load current.

Constant frequency hysteretic control mode provides extremely fast transient response without loop compensation.

Full protection features include over-current protection (OCP), output over-voltage protection (OVP) and under-voltage protection (UVP), thermal derating (TD), and thermal shutdown (TSD). The fault indicator outputs an active logic low signal if a fault condition occurs.

The MPQ7200A requires a minimal number of readily available, standard external components, and is available in a space-saving QFN-19 (3mmx4mm) package.

FEATURES

- **Built for a Wide Range of Automotive LED Applications:**
 - Wide 6V to 42V Operating Input Range
 - PWM Dimming (Dimming Frequency from 100Hz to 2kHz)
 - Internal 500Hz Two-Step Dimming with Configurable Duty Cycle
 - Available in AEC-Q100 Grade 1
- **High Performance for Improved Thermals:**
 - Configurable LED Current without Sensing Resistor
 - 44mΩ/40mΩ Low $R_{DS(ON)}$ Internal Power MOSFETs
 - High-Efficiency Synchronous Mode
- **Optimized for EMC/EMI:**
 - Default 410kHz Switching Frequency (f_{sw}) with Spread Spectrum
 - EMI Reduction Technique
- **Full Protection Features:**
 - LED Short (to GND and Battery), LED Open, and Output OVP with Fault Indication
 - OCP with Latch-Off Mode
 - Configurable Thermal Derating
 - Thermal Shutdown
- **Fast Control Loop:**
 - Band-Band Control
- **Additional Features:**
 - Configurable 1.2A in Buck-Boost Mode or 3A in Buck Mode
 - 5% LED Current Accuracy from 700mA to 1.2A for Buck-Boost or 1A to 2A for Buck
 - Available in a QFN-19 (3mmx4mm) Package with Wettable Flank

APPLICATIONS

- Turn Indicator Lights
- Daytime Running Lights (DRLs)
- Fog Lights
- Rear Lights

All MPS parts are lead-free, halogen-free, and adhere to the RoHS directive. For MPS green status, please visit the MPS website under Quality Assurance. "MPS", the MPS logo, and "Simple, Easy Solutions" are trademarks of Monolithic Power Systems, Inc. or its subsidiaries.

TYPICAL APPLICATION

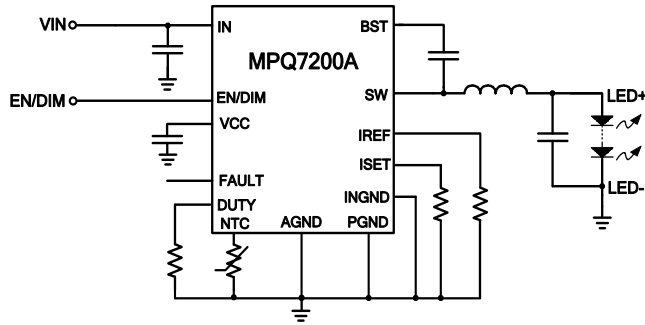

Figure 1: Buck Topology ($\geq 14.7\text{k}\Omega R_{IREF}$)

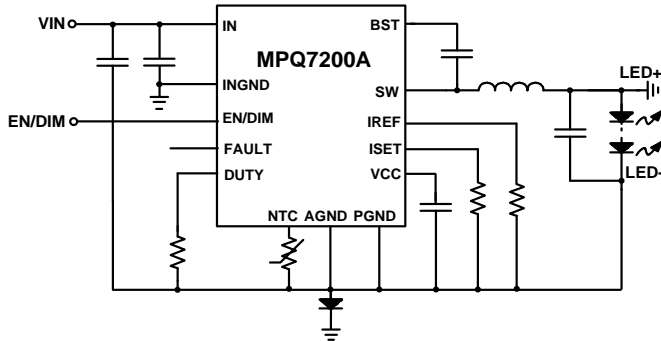
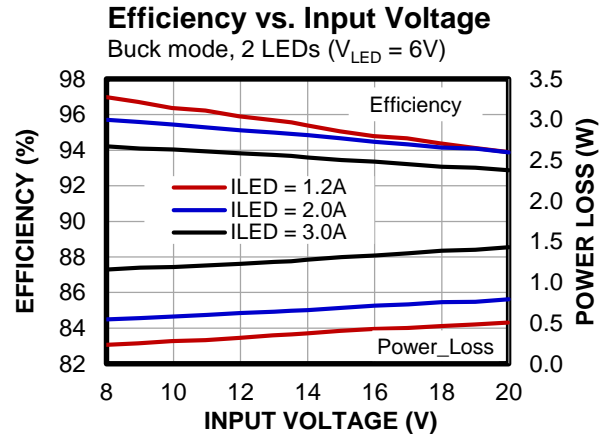
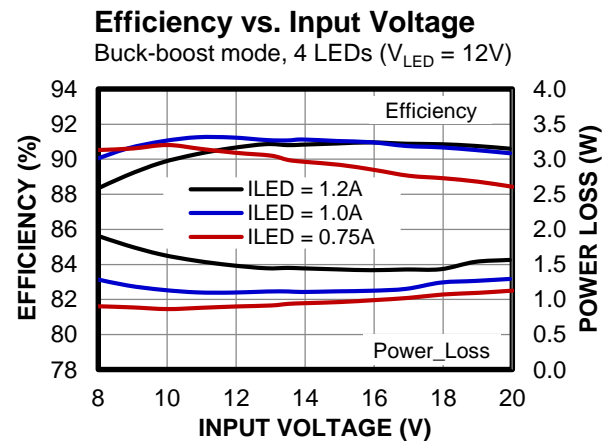

Figure 2: Buck-Boost Topology ($\leq 9.09\text{k}\Omega R_{IREF}$)



ORDERING INFORMATION

Part Number*	Package	Top Marking	MSL Rating**
MPQ7200AGLE-AEC1***	QFN-19 (3mmx4mm)	See Below	1

* For Tape & Reel, add suffix -Z (e.g. MPQ7200AGLE-AEC1-Z).

** Moisture Sensitivity Level Rating

*** Wettable Flank

TOP MARKING

MPYW

7200

ALLL

E

MP: MPS prefix
 Y: Year code
 W: Week code
 7200A: Part number
 LLL: Lot number
 E: Wettable lead flank

PACKAGE REFERENCE

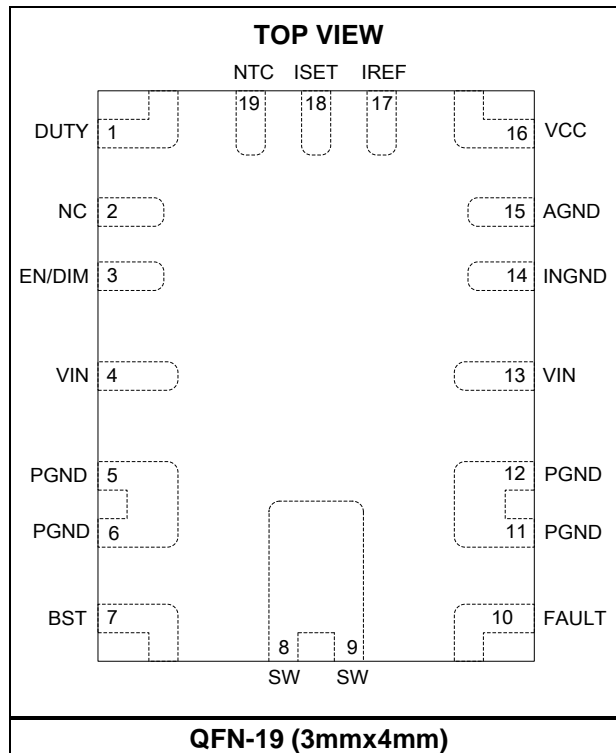

PIN FUNCTIONS

Pin #	Name	Description
1	DUTY	Two-step dimming duty setting. Connect a resistor (R_{DUTY}) between DUTY and AGND to set the duty cycle for two-step dimming or disable two-step dimming. The two-step dimming duty cycle can be set between 5% and 15%, with a 1% step. See the Two-Step Dimming section on page 44 for more details. If the DUTY pin is shorted to ground or an open condition is detected before start-up, the part latches off, and FAULT asserts.
2	NC	No connection. Leave the NC pin floating.
3	EN/DIM	Enable/dimming control. Pull EN/DIM high to enable the chip. The part starts to sense the different pin configurations at the first positive edge. Once the configuration is terminated, apply an external clock (100Hz to 2kHz) to the EN/DIM pin for PWM dimming ($R_{DUTY} = 4.87k\Omega$). EN/DIM can be connected to VIN through a maximum 100k Ω resistor. In two-step dimming, EN is off and the PWM dimming function is de-activated. Pull EN/DIM above 2.5V for 100% dimming duty; pull it below 1V for a configurable dimming duty set by R_{DUTY} (see Table 1 on page 45).
4, 13	VIN	Supply voltage. The MPQ7200A operates from a 6V to 42V input rail. An input capacitor (C_{IN}) is required to decouple the input rail. Connect VIN to the input rail using a wide PCB trace.
5, 6, 11, 12	PGND	Power ground. PGND is the reference ground of the power device, including the configuration pins (VCC, IREF, ISET, NTC, and DUTY), so it requires careful consideration when designing the PCB layout. PGND is also usually used to dissipate the thermal heat.
7	BST	Bootstrap. Connect a capacitor between the SW and BST pins to form a floating supply across the high-side MOSFET driver. A resistor can be placed between SW and the BST capacitor to reduce the SW spike voltage and improve EMI performance.
8, 9	SW	Switch output. SW is the middle point of the high-side and low-side MOSFETs. The SW node on the PCB should be small and have a wide trace to reduce noise coupling and improve EMI.
10	FAULT	Fault indicator. FAULT is an open-drain output with an internal 300k Ω pull-up resistor connected to VIN and a 4M Ω pull-down resistor connected to INGND. FAULT pulls low if a fault (LED short, LED open, over-temperature protection, false mode detection, or over-current protection) occurs. FAULT can be continuously connected to VIN through a pull-up resistor.
14	INGND	VIN, EN/DIM, and FAULT ground for buck-boost topology. For a buck topology, connect INGND to PGND/AGND.
15	AGND	Analog ground. Reference ground of the logic circuit. Connect AGND to PGND via an external trace.
16	VCC	Internal bias supply. VCC supplies power to the internal control circuit and gate drivers. A decoupling capacitor (with a real capacitance $\geq 3\mu F$) must be connected from VCC to ground, and placed close to VCC. Consider the capacitance derating. A 10 μF /10V or 16V X7R capacitor is recommended.
17	IREF	Mode selection and NTC reference current setting. Connect a $\leq 9.09k\Omega$ resistor to IREF to select buck-boost mode and a $\geq 14.7k\Omega$ resistor to select buck mode. The voltage of IREF is 0.57V after mode detection finishes. Connect a resistor (R_{IREF}) from IREF to GND to get a reference current ($0.57V / R_{IREF}$). If the IREF pin is shorted to ground or an open condition is detected, the part latches off and asserts FAULT. The current on the NTC pin is 50 times (buck mode) or 5 times (buck-boost mode) the reference current of IREF.
18	ISET	LED current set. Connect an external resistor to the ISET pin to set the LED average current. If the ISET pin is shorted to ground or an open condition is detected, the part latches off and asserts FAULT.
19	NTC	Remote temperature sense. Connect a negative temperature coefficient (NTC) and a resistor network from the NTC pin to AGND to configure the temperature derating starting point. The MPQ7200A provides protections for NTC shorts to PGND, AGND, INGND, and the battery.

ABSOLUTE MAXIMUM RATINGS ⁽¹⁾

$V_{IN} - V_{PGND/AGND}$	-0.3V to +50V
$V_{IN} - V_{INGND}$	-0.3V to +50V
$V_{INGND} - V_{PGND/AGND}$	-0.3V to +50V
$V_{FAULT} - V_{INGND}$	-0.3V to +50V
$V_{EN/DIM} - V_{INGND}$	-0.3V to +5.5V
$V_{SW} - V_{PGND/AGND}$	-0.3V to $V_{IN} - V_{PGND/AGND} + 0.3V$
V_{BST}	$V_{SW} + 5.5V$
$V_{NTC} - V_{PGND/AGND}$	-0.3V to +50V
All other pins - $V_{PGND/AGND}$	-0.3V to +5.5V
Continuous power dissipation ($T_A = 25^{\circ}C$) ⁽²⁾ ⁽⁶⁾	
QFN-19 (3mmx4mm).....	3.9W
Junction temperature.....	150°C
Lead temperature.....	260°C
Storage temperature.....	-65°C to +150°C

Electrostatic Discharge (ESD) Rating

Human body model (HBM).....	Class 2 ⁽³⁾
Charged device model (CDM).....	Class C2b ⁽⁴⁾

Recommended Operating Conditions

Supply voltage ($V_{IN} - V_{PGND}$).....	6V to 42V
LED current (I_{LED}) buck-boost mode..	Up to 1.2A
LED current (I_{LED}) buck mode.....	Up to 3A
Operating junction temp (T_J).....	-40°C to +150°C

Thermal Resistance	θ_{JA}	θ_{JC}
QFN-19 (3mmx4mm)		
JESD51-7 ⁽⁵⁾	48.....	11... °C/W
EVQ7200A-L-00A ⁽⁶⁾	32.....	6.... °C/W

Notes:

- 1) Exceeding these ratings may damage the device.
- 2) The maximum allowable power dissipation is a function of the maximum junction temperature, T_J (MAX), the junction-to-ambient thermal resistance, θ_{JA} , and the ambient temperature, T_A . The maximum allowable continuous power dissipation at any ambient temperature is calculated by P_D (MAX) = $(T_J$ (MAX) - T_A) / θ_{JA} . Exceeding the maximum allowable power dissipation can cause excessive die temperature, and the regulator may go into thermal shutdown. Internal thermal shutdown circuitry protects the device from permanent damage.
- 3) Per AEC-Q100-002.
- 4) Per AEC-Q100-011.
- 5) Measured on JESD51-7, 4-layer PCB. The value of θ_{JA} given in this table is only valid for comparison with other packages and can't be used for design purposes. These values were calculated in accordance with JESD51-7 and simulated on a specified JEDEC board. They do not represent the performance obtained in an actual application.
- 6) Measured on MPS standard EVB of MPQ7200A, 4-layer PCB, 2oz, 64mmx64mm.

ELECTRICAL CHARACTERISTICS

Buck mode, $V_{IN} = 13.5V$, $V_{EN} = 2V$, $T_J = -40^{\circ}C$ to $+150^{\circ}C$, typical values are at $T_J = 25^{\circ}C$, unless otherwise noted.

Parameter	Symbol	Condition	Min	Typ	Max	Units
Supply current (shutdown)	I_{SD}	$V_{EN} = 0V$		30	80	μA
Supply current (quiescent)	I_Q	$V_{EN} = 2V$, no switching, I_{REF} float (exclude I_{REF} and NTC current)		1.2	2	mA
		FAULT latch			2	mA
HS switch on resistance	$H_{SRDS-ON}$	$V_{BST-SW} = 5V$, $R_{ISET} = 13.3k\Omega$		44	85	m Ω
		$V_{BST-SW} = 5V$, $R_{ISET} = 40.2k\Omega$		85	160	m Ω
LS switch on resistance	$L_{SRDS-ON}$	$V_{CC} = 5.2V$, $R_{ISET} = 13.3k\Omega$		40	80	m Ω
		$V_{CC} = 5.2V$, $R_{ISET} = 40.2k\Omega$		80	150	m Ω
Switch leakage	SW_{LKG}	$V_{EN} = 0V$, $V_{SW} = 13.5V$, $T_J = 25^{\circ}C$			1	μA
		$V_{EN} = 0V$, $V_{SW} = 13.5V$			8	μA
Peak current limit ⁽⁷⁾	I_{LIMIT_PEAK}	$R_{ISET} = 40.2k\Omega$	2.65	3.15	3.65	A
		$R_{ISET} = 13.3k\Omega$	5.3	6.3	7.3	A
ZCD ⁽⁷⁾				50		mA
Switching/oscillator frequency	f_{SW}	FSS activated	320	410	500	kHz
Minimum on time ⁽⁷⁾	t_{ON_MIN}			55	80	ns
Minimum off time ⁽⁷⁾	t_{OFF_MIN}			75	100	ns
Maximum duty cycle ⁽⁷⁾	D_{MAX}	Low dropout	95	98		%
Spread spectrum Frequency ⁽⁷⁾				15		kHz
Spread spectrum Frequency range ⁽⁷⁾				$\pm 10\%$		fsw
LED current	I_{LED}	$R_{ISET} = 13.3k\Omega$, $T_J = 25^{\circ}C$ to $100^{\circ}C$	1.14	1.2	1.26	A
		$R_{ISET} = 13.3k\Omega$	1.02	1.2	1.38	
LED current threshold for MOSFET cut	I_{LED_CUT}			600	700	mA
ISET voltage	V_{ISET}	$I_{ISET} = 45\mu A$	0.578	0.592	0.606	V
ISET current threshold for pin short		$I_{LED} < I_{LED_CUT}$	80	120	160	μA
		$I_{LED} > I_{LED_CUT}$	180	220	260	μA
ISET current threshold for pin open			0.5	1.4	5	μA
EN rising threshold	V_{EN_RISING}	$V_{EN} - V_{INGND}$	1.2	1.67	2.5	V
EN falling threshold	$V_{EN_FALLING}$	$V_{EN} - V_{INGND}$	1	1.58	2.2	V
EN threshold hysteresis	V_{EN_HYS}	$V_{EN} - V_{INGND}$		100		mV
EN input current	I_{EN}	$V_{EN} - V_{INGND} = 2V$		2	8	μA
		$V_{EN} - V_{INGND} = 0V$		0	0.2	μA

ELECTRICAL CHARACTERISTICS (continued)

Buck mode, $V_{IN} = 13.5V$, $V_{EN} = 2V$, $T_J = -40^{\circ}C$ to $+150^{\circ}C$, typical values are at $T_J = 25^{\circ}C$, unless otherwise noted.

Parameter	Symbol	Condition	Min	Typ	Max	Units
EN turn-off delay	EN _{TD-OFF}		10	25	45	ms
V _{IN} under-voltage lockout rising threshold	INUV _{VTH_R}	$V_{IN} - V_{INGND}$	5.75	6	6.25	V
V _{IN} under-voltage lockout falling threshold	INUV _{VTH_F}	$V_{IN} - V_{INGND}$	4.5	4.9	5.2	V
V _{IN} under-voltage lockout threshold hysteresis	INUV _{HYS}	$V_{IN} - V_{INGND}$		1.1		V
V _{CC} under-voltage lockout rising threshold	V _{CC_VTH}	$V_{CC} - V_{AGND}$	4.4	4.7	5	V
V _{CC} under-voltage lockout falling threshold		$V_{CC} - V_{AGND}$	3.4	4.05	4.7	V
V _{CC} under-voltage lockout threshold hysteresis	V _{CC_HYS}	$V_{CC} - V_{AGND}$		650		mV
V _{CC} regulator	V _{CC}	I _{CC} = 0mA	4.9	5.1	5.3	V
V _{CC} load regulation		I _{CC} = 20mA	4.7			V
V _{CC} max current ability		$V_{CC} = V_{CC_UVLO} + 100mV$, no switching	50	80	120	mA
V _{CC} source current ability ⁽⁷⁾		$V_{CC} = V_{CC_UVLO} + 100mV$, switching		25		mA
DUTY source current	I _{DUTY}	I _{DUTY1}	40	45	50	μA
		I _{DUTY2}	540	600	650	μA
V _{DUTY} threshold maxim		I _{DUTY1} and I _{DUTY2}	3.287	3.355	3.422	V
V _{DUTY} threshold minimum ⁽⁷⁾		I _{DUTY1} and I _{DUTY2}	0.28	0.302	0.34	V
Two-step dimming frequency ⁽⁷⁾				500		Hz
Output under-voltage threshold	UV _{VTH}		0.6	1.1	1.7	V
LED low current threshold		I _{LED_SETTING} < I _{LED_CUT}	45	60	75	mA
		I _{LED_SETTING} > I _{LED_CUT}	100	120	150	mA
FAULT assertion delay time during start-up	t _{FT-D-START}		25	35	40	ms
FAULT assertion deglitch time after start-up ⁽⁷⁾	t _{FT-D}			20		μs
FAULT assertion low sink current ability	I _{FAULT_SINK}	V _{FAULT} = 12V	10	30	50	mA
		V _{FAULT} = 0.2V	5	12		mA
FAULT threshold for part shutdown			2.8	3.2	3.7	V
FAULT pull-up resistor			100	300	500	kΩ
FAULT pull-down resistor			2000	4000	6000	kΩ
I _{REF} current for mode detection			200	240	280	μA

ELECTRICAL CHARACTERISTICS *(continued)*

Buck mode, $V_{IN} = 13.5V$, $V_{EN} = 2V$, $T_J = -40^{\circ}C$ to $+150^{\circ}C$, typical values are at $T_J = 25^{\circ}C$, unless otherwise noted.

Parameter	Symbol	Condition	Min	Typ	Max	Units
V_{IREF} threshold for mode detection			2.6	2.7	2.8	V
IREF voltage	V_{IREF}	$I_{IREF} = 20\mu A$	0.50	0.57	0.63	V
IREF current threshold for pin short detection			60	90	120	μA
IREF current threshold for pin open detection				3	6	μA
NTC source current	I_{NTC}	$V_{NTC} = 1.25V$, $I_{REF} = 20\mu A$	925	1020	1060	μA
NTC voltage for current derating		$I_{LED} = 98\%$ of nominal	-2.5%	1.25	+2.5%	V
		$I_{LED} = 58\%$ of nominal	-2.5%	0.65	+2.5%	V
V_{NTC} threshold for OTP				0.37		V
V_{NTC} deglitch time for OTP		$V_{NTC} = 0.3V$	180	256	320	μs
V_{NTC} recovery threshold for OTP		I_{NTC1}		0.48		V
Thermal shutdown ⁽⁷⁾			155	170	185	$^{\circ}C$

ELECTRICAL CHARACTERISTICS (continued)

Buck-boost mode, $V_{IN} = 13.5V$, $V_{EN} = 2V$, $T_J = -40^{\circ}C$ to $+150^{\circ}C$, typical values are at $T_J = 25^{\circ}C$, unless otherwise noted.

Parameter	Symbol	Condition	Min	Typ	Max	Units
Supply current (shutdown)	I_{SD}	$V_{EN} = 0V$		30	80	μA
Supply current (quiescent)	I_Q	$V_{EN} = 2V$, no switching, IREF floating (exclude IREF and I _{NTC} current)		1.2	2	mA
		FAULT latch			2	mA
HS switch on resistance	$H_{SRDS-ON}$	$V_{BST-SW} = 5V$, $R_{ISET} = 13.3k\Omega$		44	85	m Ω
LS switch on resistance	$L_{SRDS-ON}$	$V_{CC} = 5.2V$, $R_{ISET} = 13.3k\Omega$		40	80	m Ω
Switch leakage	SW_{LKG}	$V_{EN} = 0V$, $V_{SW} = 13.5V$, $T_J = 25^{\circ}C$			1	μA
		$V_{EN} = 0V$, $V_{SW} = 13.5V$			8	μA
Peak current limit ⁽⁷⁾	I_{LIMIT_PEAK}		5.3	6.3	7.3	A
ZCD ⁽⁷⁾				50		mA
Switching/oscillator frequency	f_{SW}	FSS activated	320	410	500	kHz
Minimum on time ⁽⁷⁾	t_{ON_MIN}			55	80	ns
Minimum off time ⁽⁷⁾	t_{OFF_MIN}			75	100	ns
Maximum duty cycle ⁽⁷⁾	D_{MAX}	Low dropout	95	98		%
Spread spectrum frequency ⁽⁷⁾				15		kHz
Spread spectrum frequency range ⁽⁷⁾				$\pm 10\%$		fsw
LED current	I_{LED}	$R_{ISET} = 21.5k\Omega$, $T_J = 25^{\circ}C$ to $100^{\circ}C$	0.7125	0.75	0.7875	A
		$R_{ISET} = 21.5k\Omega$	0.6375	0.75	0.8625	
		$R_{ISET} = 13.3k\Omega$, $T_J = 25^{\circ}C$ to $100^{\circ}C$	1.14	1.2	1.26	A
		$R_{ISET} = 13.3k\Omega$	1.02	1.2	1.38	
ISET voltage	V_{ISET}	$I_{ISET} = 45\mu A$	0.578	0.592	0.606	V
Power derating ratio		$V_{IN} = 6.6V$, V_{ISET} respect to nominal	91.5	95	98.5	%
		$V_{IN} = 5.3V$, V_{ISET} respect to nominal	72.5	76	79.5	%
ISET current threshold for pin short			90	110	130	μA
ISET current threshold for pin open			0.5	1.4	5	μA
EN rising threshold	V_{EN_RISING}	$V_{EN} - V_{INGND}$	1.2	1.67	2.5	V
EN falling threshold	$V_{EN_FALLING}$	$V_{EN} - V_{INGND}$	1.0	1.58	2.2	V
EN threshold hysteresis	V_{EN_HYS}	$V_{EN} - V_{INGND}$		100		mV
EN input current	I_{EN}	$V_{EN} = 2V$		2	8	μA
		$V_{EN} = 0V$		0	0.2	μA
EN turn-off delay	$t_{EN-D-OFF}$		10	25	45	ms

ELECTRICAL CHARACTERISTICS (continued)

Buck-boost mode, $V_{IN} = 13.5V$, $V_{EN} = 2V$, $T_J = -40^{\circ}C$ to $+150^{\circ}C$, typical values are at $T_J = 25^{\circ}C$, unless otherwise noted.

Parameter	Symbol	Condition	Min	Typ	Max	Units
VIN under-voltage lockout rising threshold	INUV _{VTH_R}	$V_{IN} - V_{INGND}$	5.75	6	6.25	V
VIN under-voltage lockout falling threshold	INUV _{VTH_F}	$V_{IN} - V_{INGND}$	4.5	4.9	5.2	V
VIN under-voltage lockout threshold hysteresis	INUV _{HYS}	$V_{IN} - V_{INGND}$		1.1		V
VCC under-voltage lockout rising threshold	V _{CC_VTH}	$V_{CC} - V_{AGND}$	4.4	4.7	5	V
VCC under-voltage lockout falling threshold		$V_{CC} - V_{AGND}$	3.4	4.05	4.7	V
VCC under-voltage lockout threshold hysteresis	V _{CC_HYS}	$V_{CC} - V_{AGND}$		650		mV
VCC regulator	V _{CC}	$I_{VCC} = 0mA$	4.9	5.1	5.3	V
VCC load regulation		$I_{VCC} = 20mA$	4.7			V
VCC max current ability		$V_{CC} = V_{CC_UVLO} + 100mV$, no switching	50	80	120	mA
VCC source current ability ⁽⁷⁾		$V_{CC} = V_{CC_UVLO} + 100mV$, switching		25		mA
DUTY source current	I _{DUTY}	I _{DUTY1}	40	45	50	μA
		I _{DUTY2}	540	600	650	μA
VDUTY threshold maxim		I _{DUTY1} and I _{DUTY2}	3.287	3.355	3.422	V
VDUTY threshold minimum ⁽⁷⁾		I _{DUTY1} and I _{DUTY2}	0.28	0.302	0.34	V
Two-step dimming frequency ⁽⁷⁾				500		Hz
Output over-voltage threshold	OV _{VTH}	$V_{INGND} - V_{AGND}$	19.5	20.5	21.5	V
Output under-voltage threshold	UV _{VTH}	$V_{INGND} - V_{AGND}$	1	1.35	1.7	V
VIN load dump protection threshold			38	40	42	V
VIN load dump protection falling threshold			37	39	41	V
VIN load dump protection hysteresis				1		V
Output discharge current for load dump protection		$V_{INGND} - V_{PGND} > 5V$	40	100	180	mA
		$V_{INGND} - V_{PGND} = 1V$	20	45	90	mA
FAULT assertion delay time when startup	t _{FT-D-START}		25	35	40	ms
FAULT assertion deglitch time after startup	t _{FT-D}			20		μs

ELECTRICAL CHARACTERISTICS (continued)

Buck-boost mode, $V_{IN} = 13.5V$, $V_{EN} = 2V$, $T_J = -40^{\circ}C$ to $+150^{\circ}C$, typical values are at $T_J = 25^{\circ}C$, unless otherwise noted.

Parameter	Symbol	Condition	Min	Typ	Max	Units
FAULT assertion low sink current ability	I_{FAULT_SINK}	$V_{FAULT} = 12V$	10	30	50	mA
		$V_{FAULT} = 0.2V$	5	12		mA
FAULT threshold for part shutdown			2.8	3.2	3.7	V
FAULT pull-up resistor			100	300	500	k Ω
FAULT pull-down resistor			2000	4000	6000	k Ω
IREF current for mode detection			200	240	280	μA
V_{IREF} threshold for mode detection			2.6	2.7	2.8	V
IREF voltage	V_{IREF}	$I_{IREF} = 20\mu A$	0.50	0.57	0.63	V
IREF current threshold for pin short detection			600	900	1200	μA
IREF current threshold for open pin detection				40	70	μA
NTC source current	I_{NTC}	$V_{NTC} = 1.25V$, $I_{IREF} = 200\mu A$	925	1020	1060	μA
NTC voltage for current derating		$I_{LED} = 98\%$ of nominal	-2.5%	1.25	+2.5%	V
		$I_{LED} = 76\%$ of nominal	-2.5%	0.65	+2.5%	V
V_{NTC} threshold for OTP				0.37		V
V_{NTC} deglitch time for OTP		$V_{NTC} = 0.3V$	180	256	320	μs
V_{NTC} recovery threshold for OTP		I_{NTC1}		0.48		V
Thermal shutdown ⁽⁷⁾			155	170	185	$^{\circ}C$

Note:

7) Not tested in production. Guaranteed by design and characterization.

TYPICAL CHARACTERISTICS

$V_{IN} = 12V$, $T_J = -40^{\circ}C$ to $+150^{\circ}C$, unless otherwise noted.

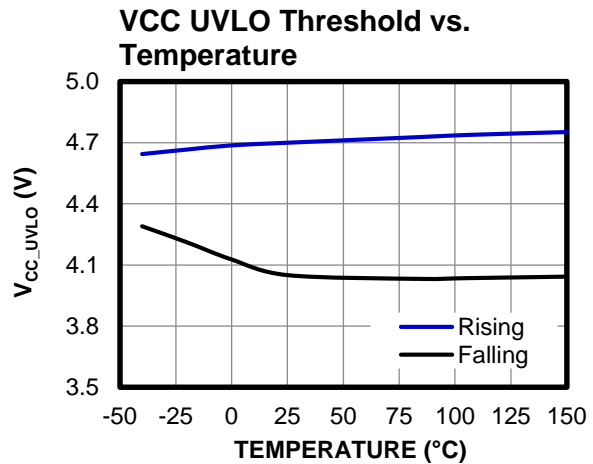
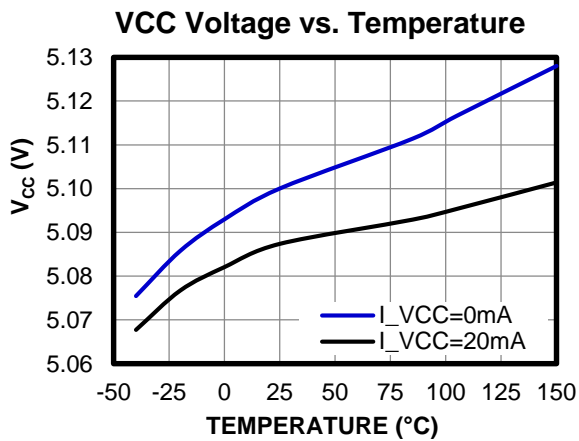
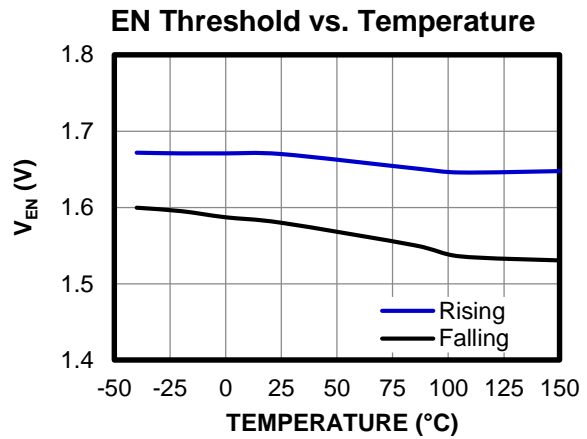
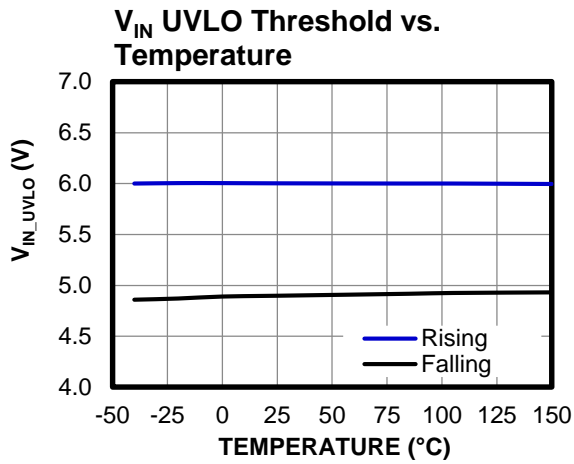
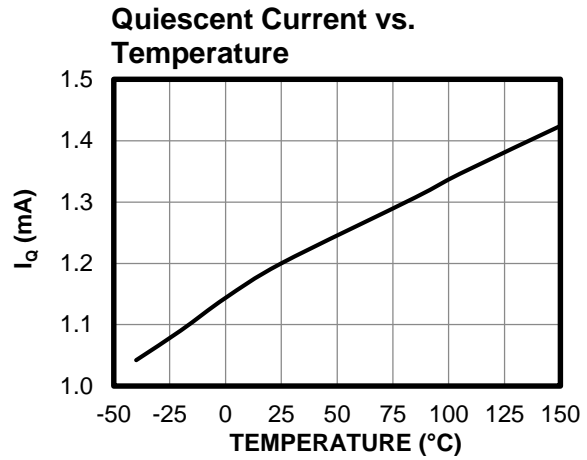
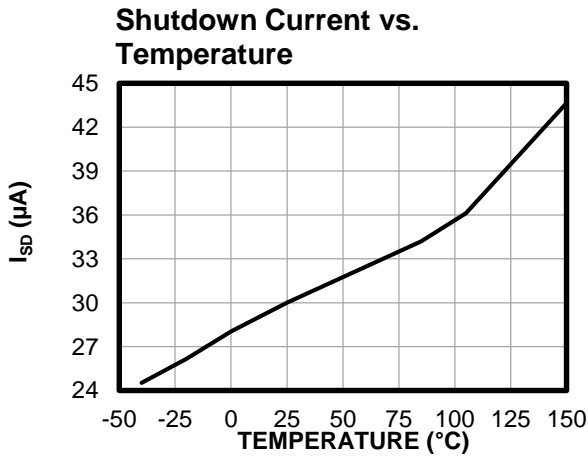

TYPICAL CHARACTERISTICS (continued)

$V_{IN} = 12V$, $T_J = -40^{\circ}C$ to $+150^{\circ}C$, unless otherwise noted.

Current Limit with MOSFETs Fully On vs. Temperature

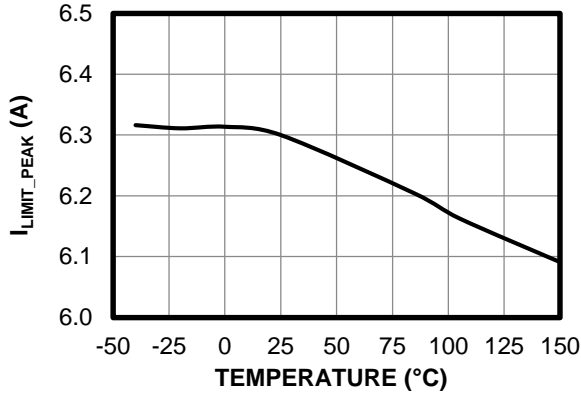

Current Limit with MOSFETs Half On vs. Temperature

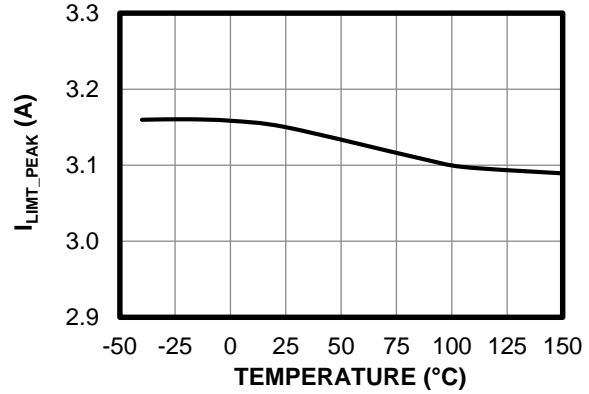

V_{IREF} vs. Temperature

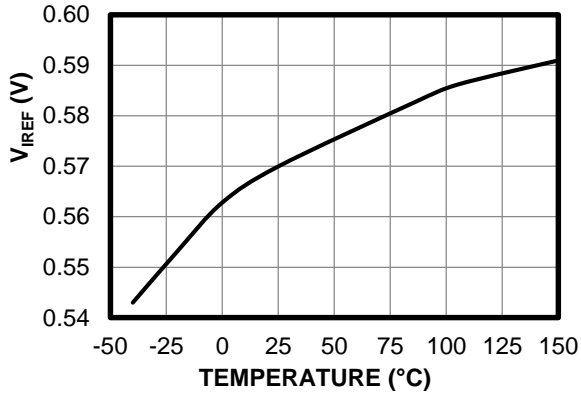

V_{ISET} vs. Temperature

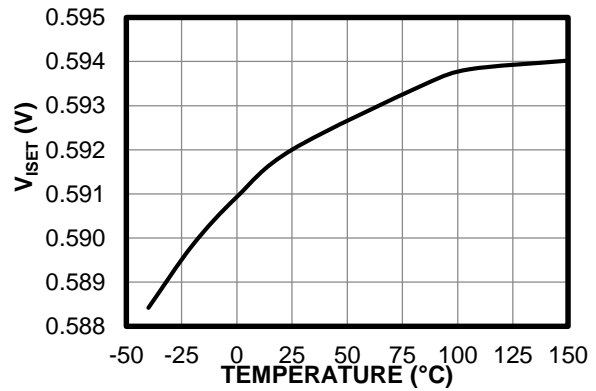

Switching Frequency vs. Temperature

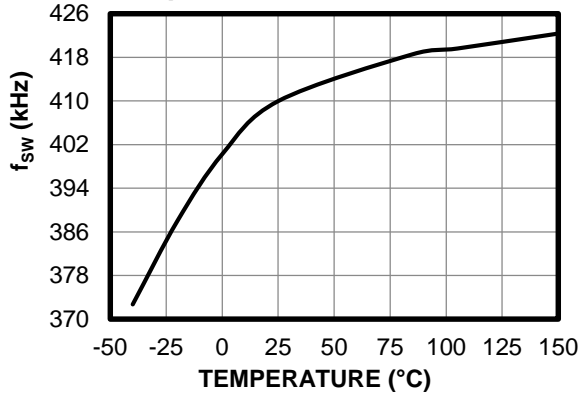

V_{OUT} UV Threshold vs. Temperature

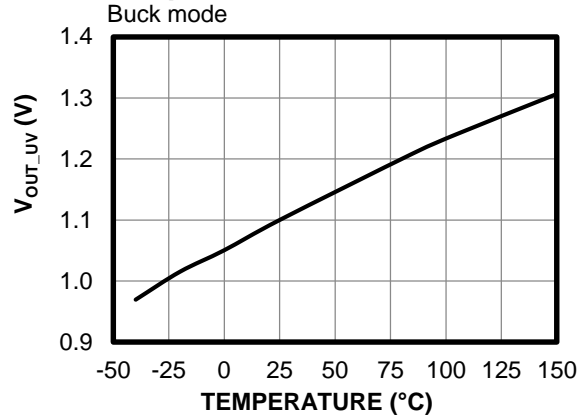

TYPICAL CHARACTERISTICS (continued)

$V_{IN} = 12V$, $T_J = -40^{\circ}C$ to $+150^{\circ}C$, unless otherwise noted.

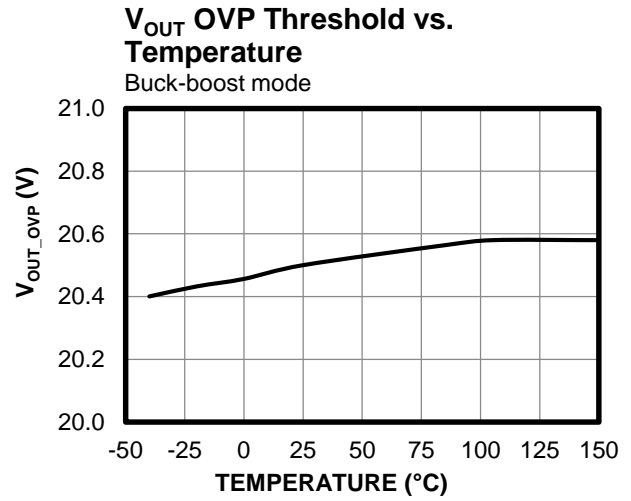
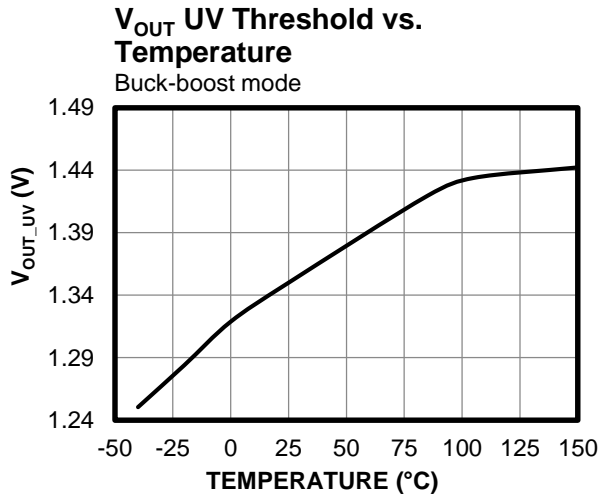

TYPICAL PERFORMANCE CHARACTERISTICS

Buck mode, 2 LEDs ($V_{LED} = 6V$), $V_{IN} = 13.5V$, $I_{LED} = 3A$, $f_{SW} = 410kHz$, $L = 10\mu H$, $T_A = 25^\circ C$, unless otherwise noted.

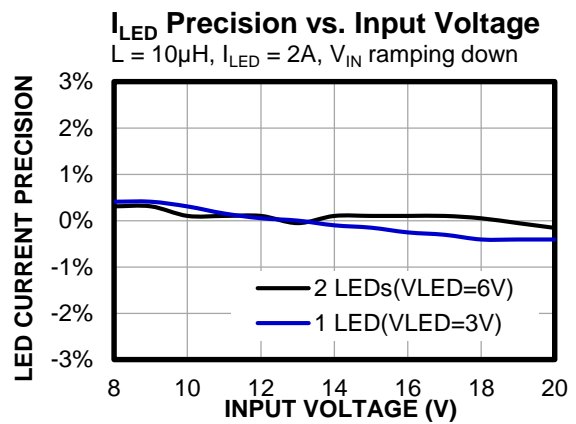
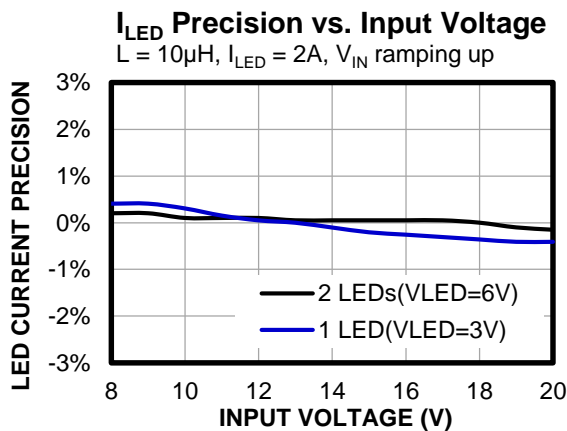
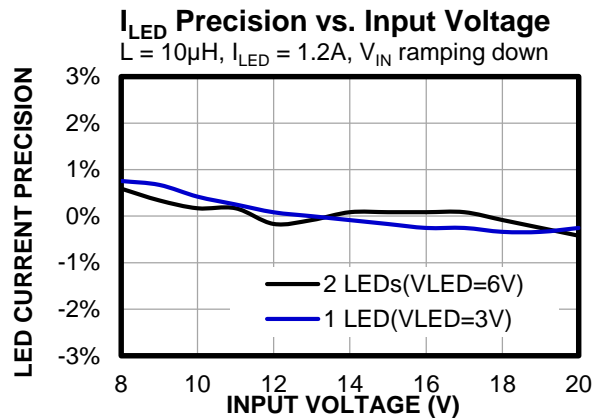
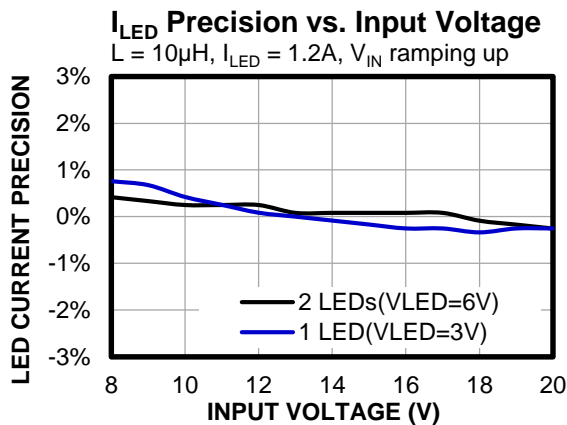
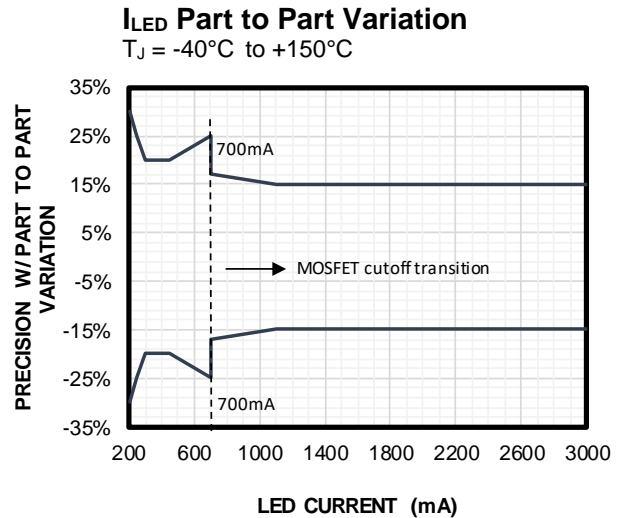
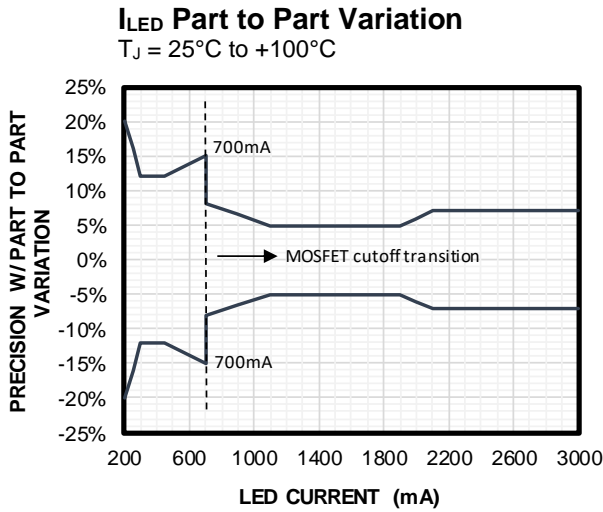

TYPICAL PERFORMANCE CHARACTERISTICS (continued)

Buck mode, 2 LEDs ($V_{LED} = 6V$), $V_{IN} = 13.5V$, $I_{LED} = 3A$, $f_{SW} = 410kHz$, $L = 10\mu H$, $T_A = 25^\circ C$, unless otherwise noted.

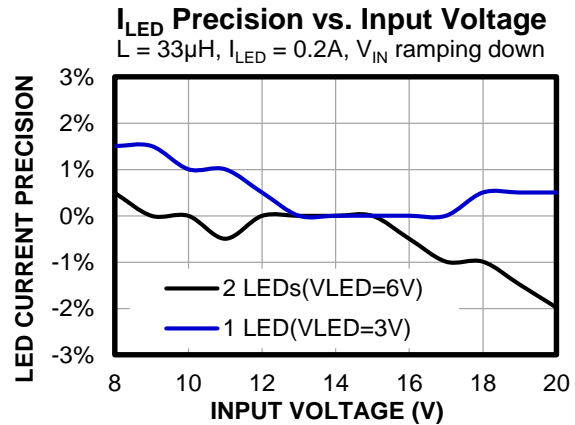
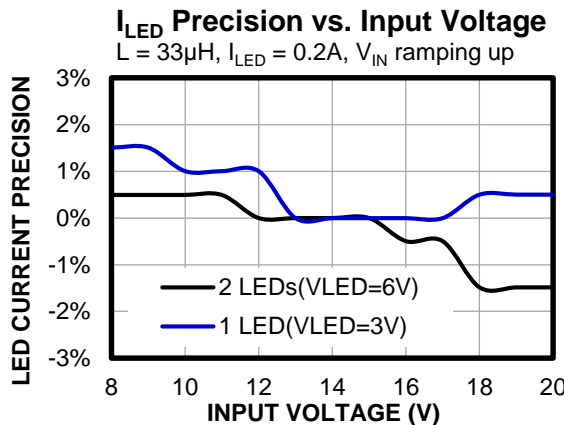
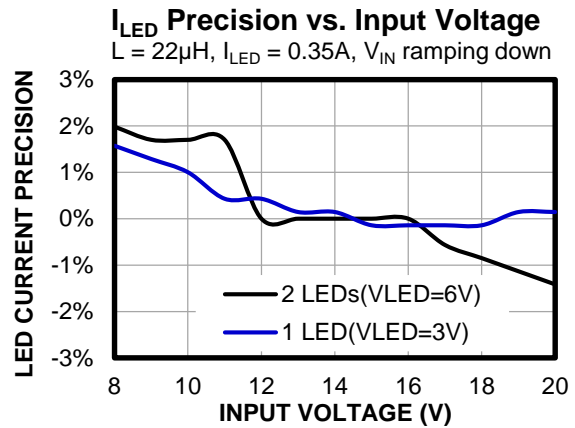
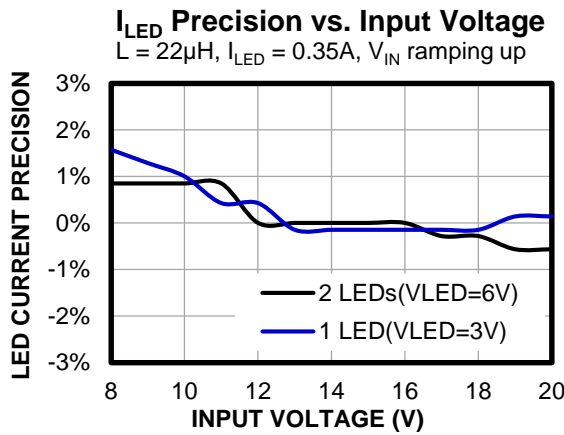
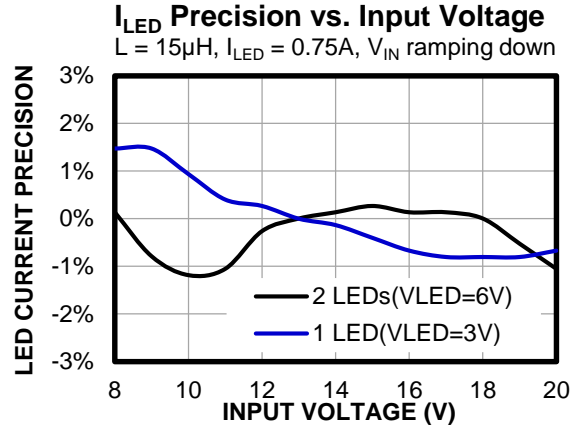
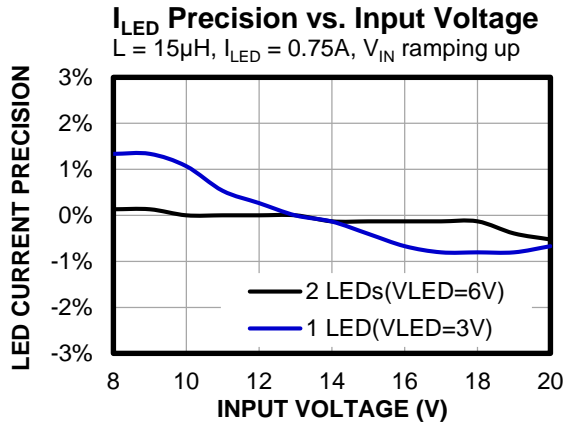

TYPICAL PERFORMANCE CHARACTERISTICS (continued)

Buck mode, 2 LEDs ($V_{LED} = 6V$), $V_{IN} = 13.5V$, $I_{LED} = 3A$, $f_{SW} = 410kHz$, $L = 10\mu H$, $T_A = 25^\circ C$, unless otherwise noted.

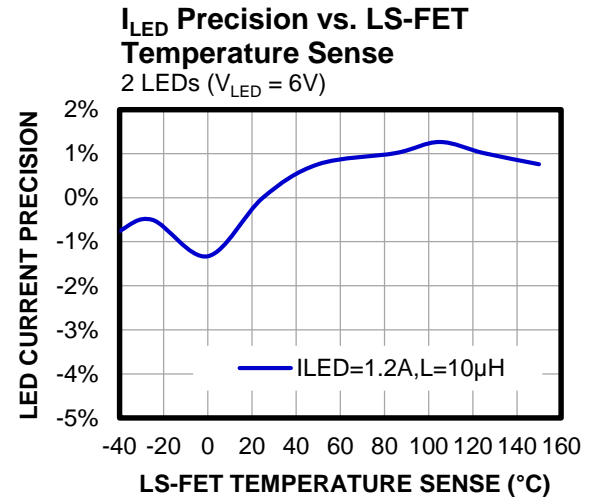
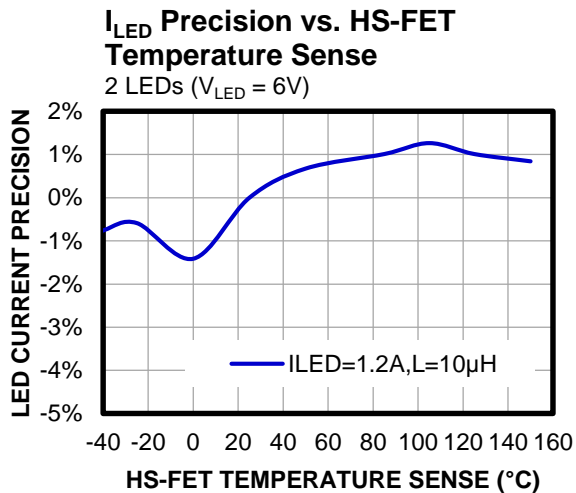
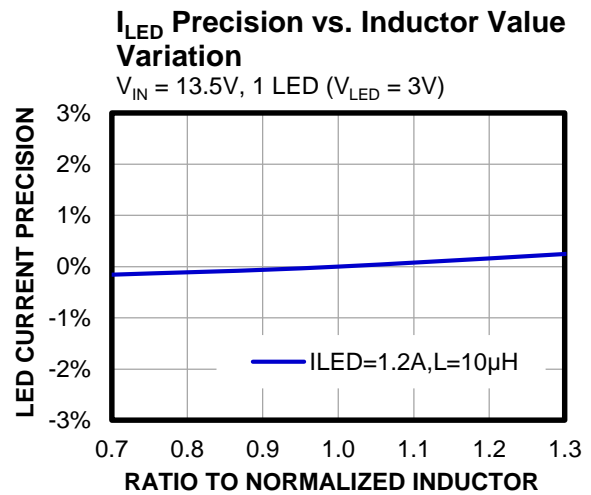
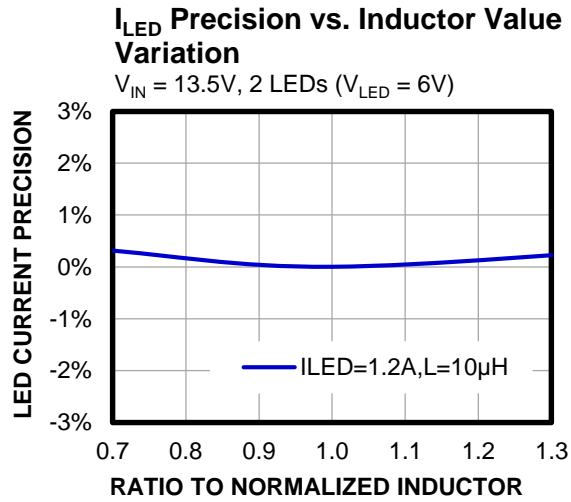

V_{IN} Slow Ramp Up and Down
 2 LEDs ($V_{LED} = 6V$), $I_{LED} = 1.2A$, $V_{IN} = 0V$ to $20V$, $0.001V/ms$

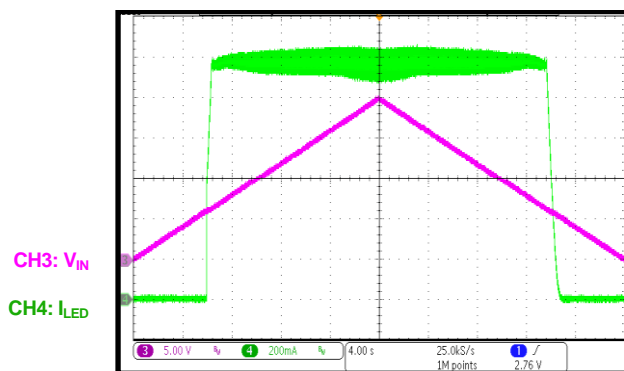

V_{IN} Slow Ramp Up and Down
 1 LED ($V_{LED} = 3V$), $I_{LED} = 1.2A$, $V_{IN} = 0V$ to $20V$, $0.001V/ms$

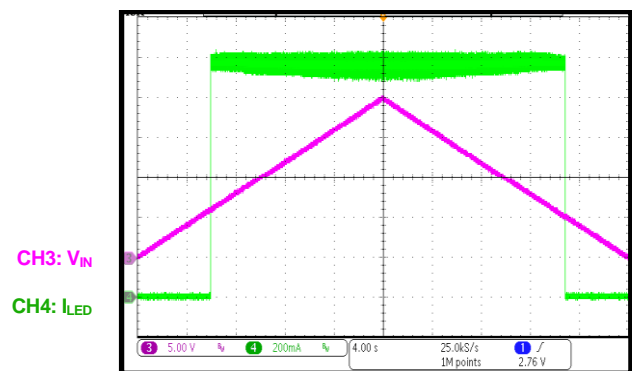

TYPICAL PERFORMANCE CHARACTERISTICS

Buck mode, $V_{IN} = 12V$, 2 LEDs in series ($V_{LED} = 6V$), $I_{LED} = 3A$, $L = 10\mu H$, $f_{SW} = 410kHz$, with EMI filters, $T_A = 25^\circ C$, unless otherwise noted. ⁽⁸⁾

CISPR25 Class 5 Peak Conducted Emissions

150kHz to 108MHz

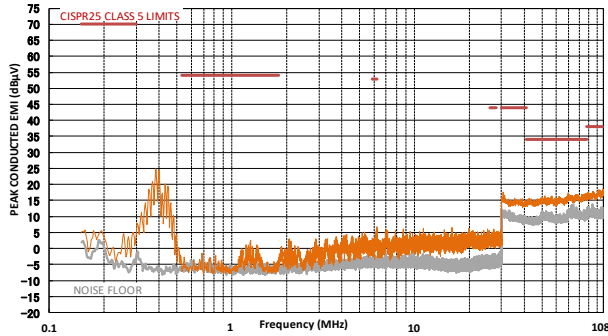

CISPR25 Class 5 Average Conducted Emissions

150kHz to 108MHz

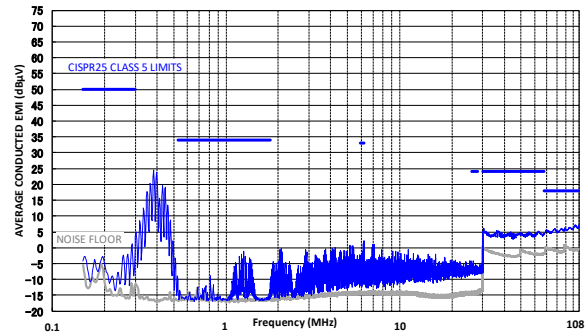

CISPR25 Class 5 Peak Radiated Emissions

150kHz to 30MHz

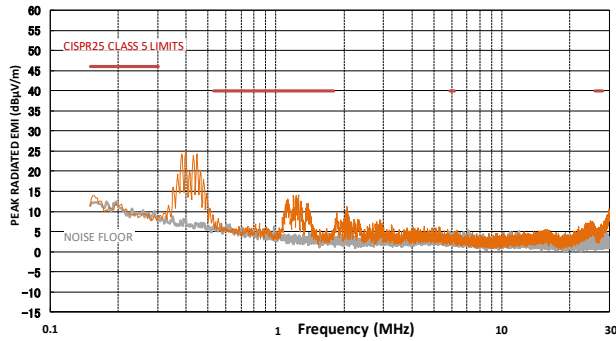

CISPR25 Class 5 Average Radiated Emissions

150kHz to 30MHz

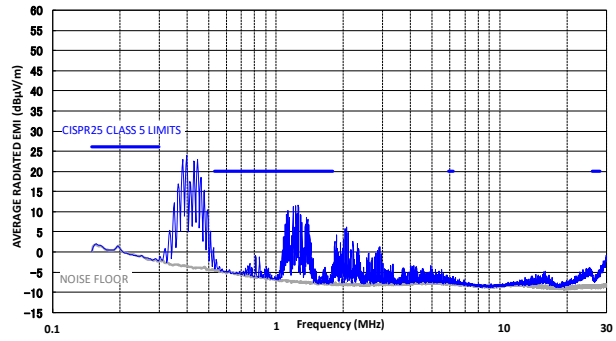

CISPR25 Class 5 Peak Radiated Emissions

Horizontal, 30MHz to 200MHz

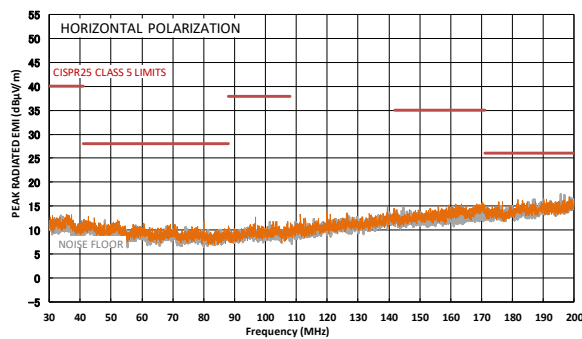

CISPR25 Class 5 Average Radiated Emissions

Horizontal, 30MHz to 200MHz

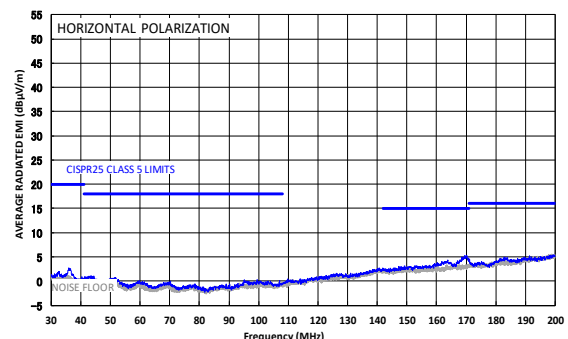

TYPICAL PERFORMANCE CHARACTERISTICS (continued)

Buck mode, $V_{IN} = 12V$, 2 LEDs in series ($V_{LED} = 6V$), $I_{LED} = 3A$, $L = 10\mu H$, $f_{SW} = 410kHz$, with EMI filters, $T_A = 25^\circ C$, unless otherwise noted. ⁽⁸⁾

CISPR25 Class 5 Peak Radiated Emissions

Vertical, 30MHz to 200MHz

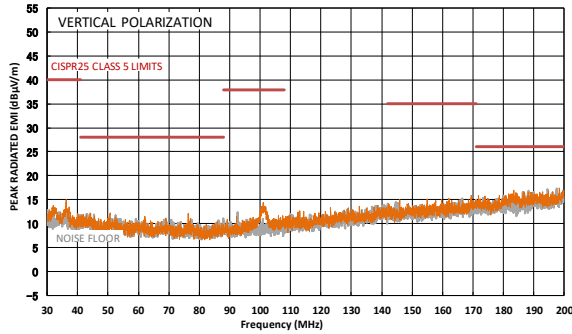

CISPR25 Class 5 Average Radiated Emissions

Vertical, 30MHz to 200MHz

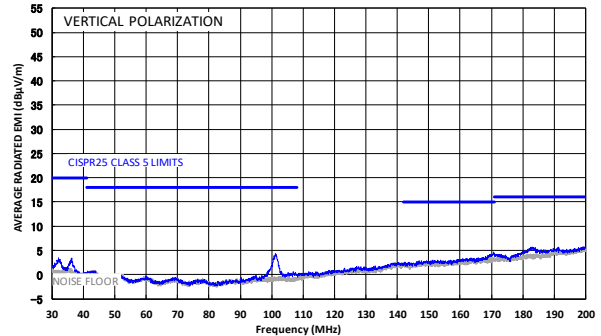

CISPR25 Class 5 Peak Radiated Emissions

Horizontal, 200MHz to 1GHz

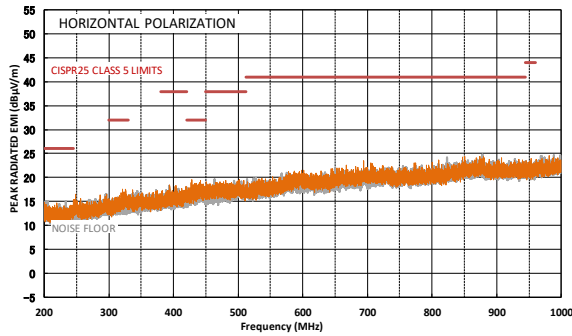

CISPR25 Class 5 Average Radiated Emissions

Horizontal, 200MHz to 1GHz

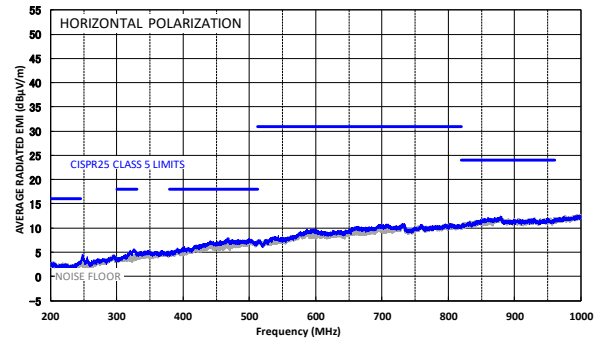

CISPR25 Class 5 Peak Radiated Emissions

Vertical, 200MHz to 1GHz

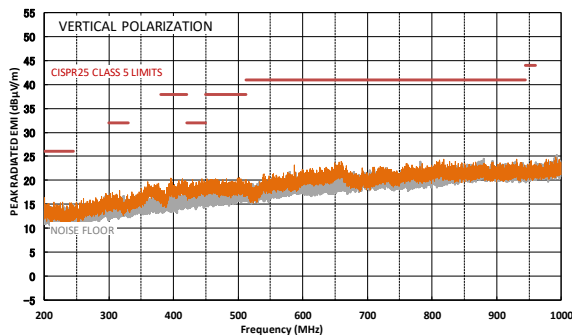

CISPR25 Class 5 Average Radiated Emissions

Vertical, 200MHz to 1GHz

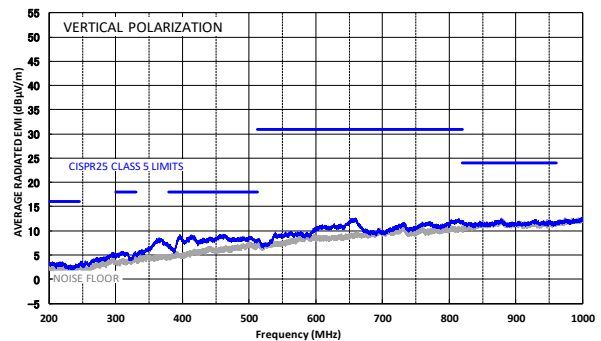

Notes:

8) The MPQ7200A buck mode EMC test results are based on the application circuit with EMI filters (see Figure 9 on page 54).

TYPICAL PERFORMANCE CHARACTERISTICS (continued) ⁽⁹⁾

Buck mode, 2 LEDs ($V_{LED} = 6V$), $V_{IN} = 13.5V$, $I_{LED} = 3A$, $f_{SW} = 410kHz$, $L = 10\mu H$, $T_A = 25^\circ C$, unless otherwise noted.

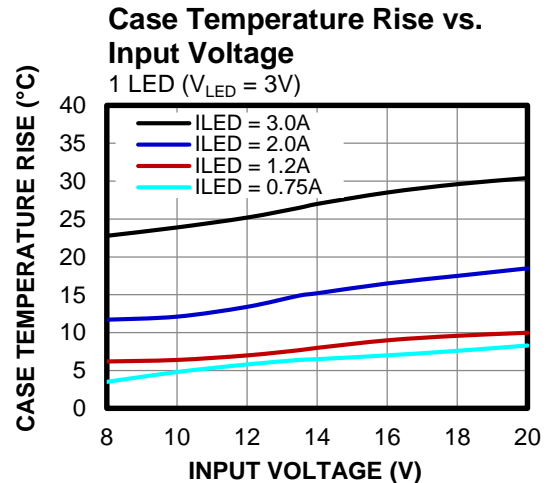
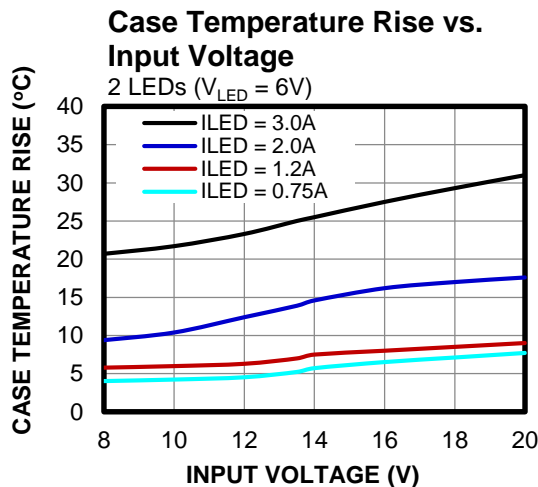
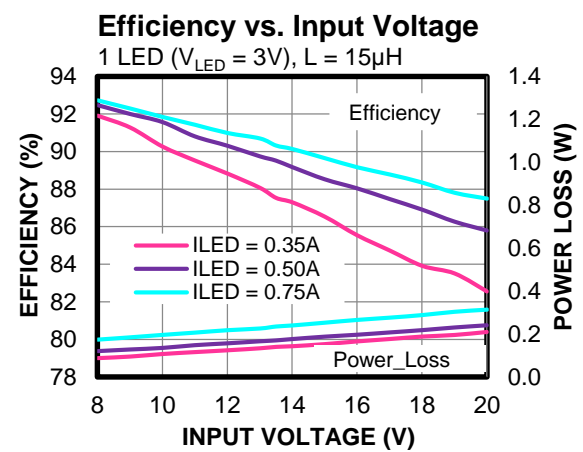
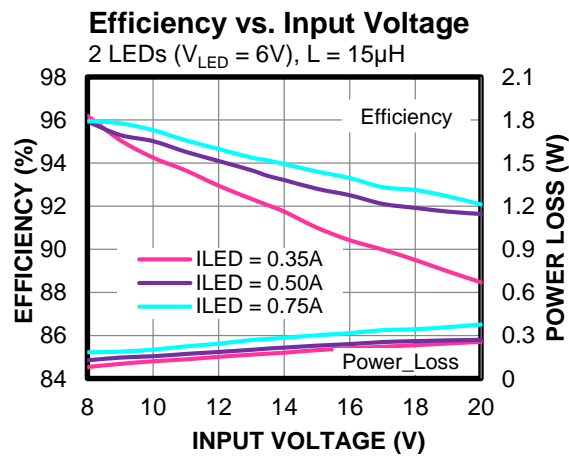
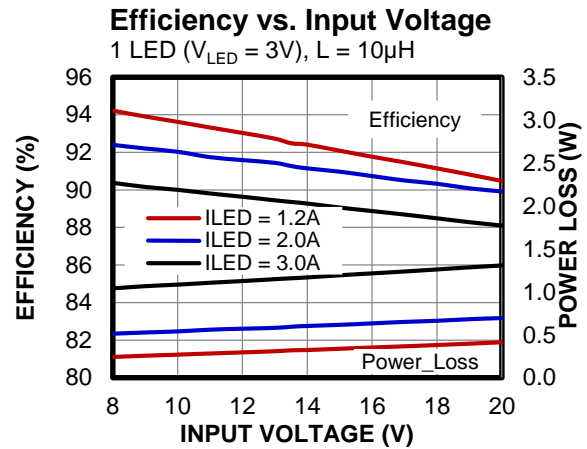
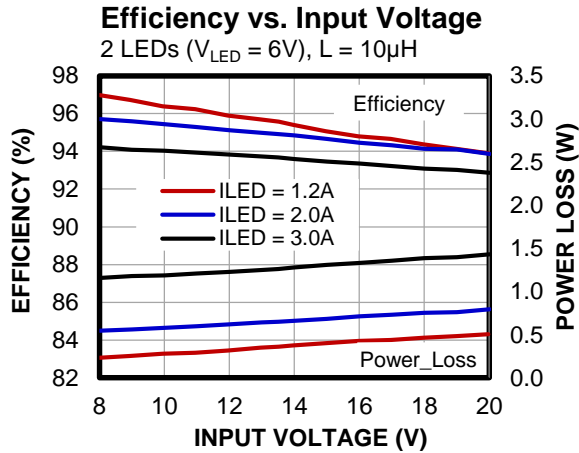

Note:

9) The efficiency and thermal curve is based on Figure 9 when $R_{BST} = 0\Omega$, and the output and input filters have been removed. $L = 10\mu H$: XAL5050-103MEB, $L = 15\mu H$: XAL4040-153MEB.

TYPICAL PERFORMANCE CHARACTERISTICS *(continued)*

Buck mode, 2 LEDs ($V_{LED} = 6V$), $V_{IN} = 13.5V$, $I_{LED} = 3A$, $f_{SW} = 410kHz$, $L = 10\mu H$, $T_A = 25^\circ C$, unless otherwise noted.

Steady State

$I_{LED} = 3A$

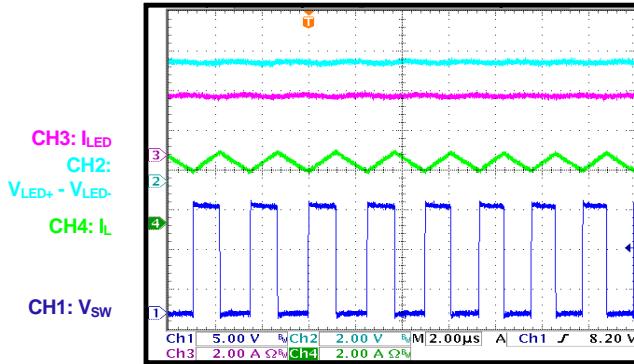

Start-Up through VIN

$I_{LED} = 3A$

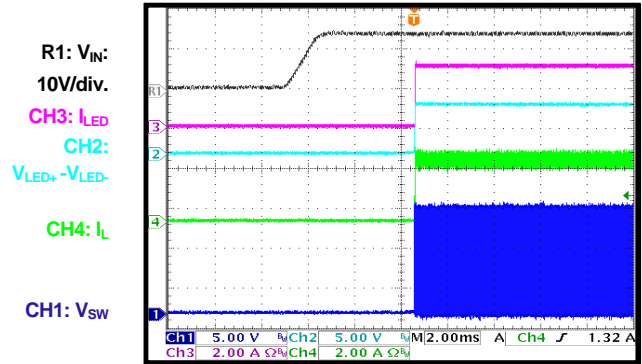

Shutdown through VIN

$I_{LED} = 3A$

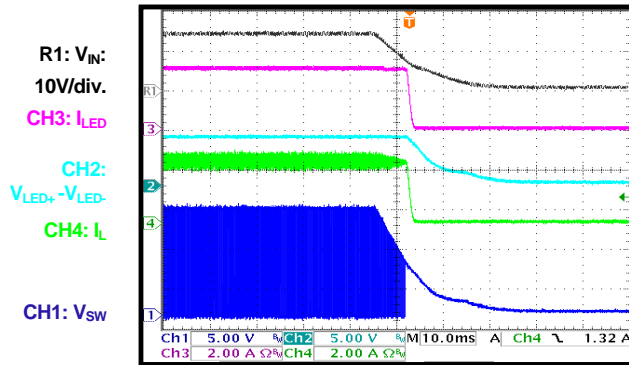

Start-Up through EN

$I_{LED} = 3A$

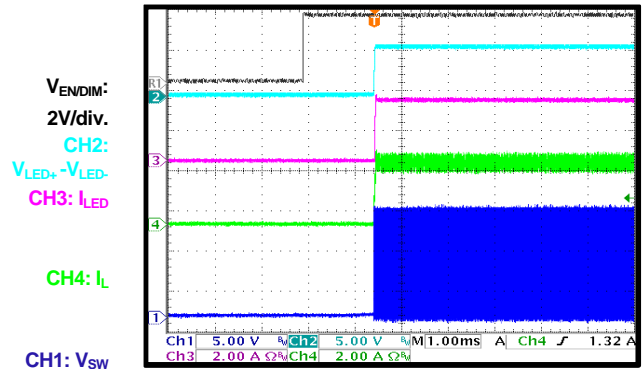

Shut-Down through EN

$I_{LED} = 3A$

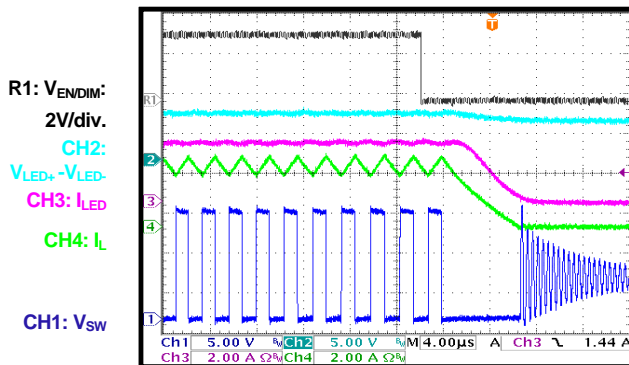

PWM Dimming Steady State

Dimming frequency = 100Hz

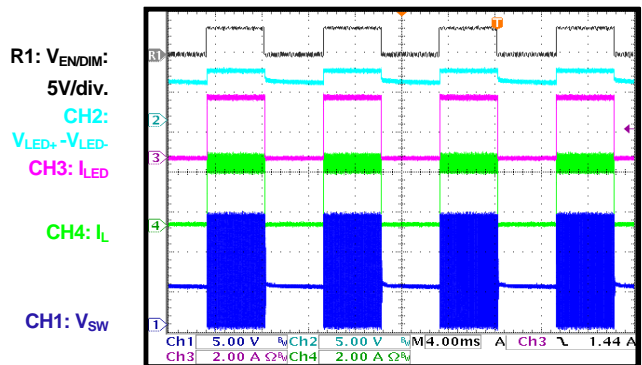

TYPICAL PERFORMANCE CHARACTERISTICS (continued)

Buck mode, 2 LEDs ($V_{LED} = 6V$), $V_{IN} = 13.5V$, $I_{LED} = 3A$, $f_{SW} = 410kHz$, $L = 10\mu H$, $T_A = 25^\circ C$, unless otherwise noted.

PWM Dimming Steady State
Dimming frequency = 2kHz

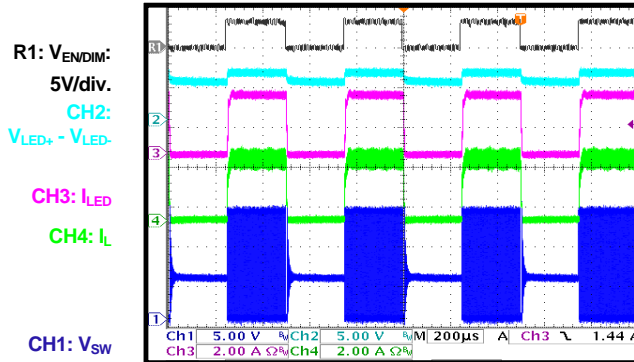

PWM Dimming
Start-up through VIN

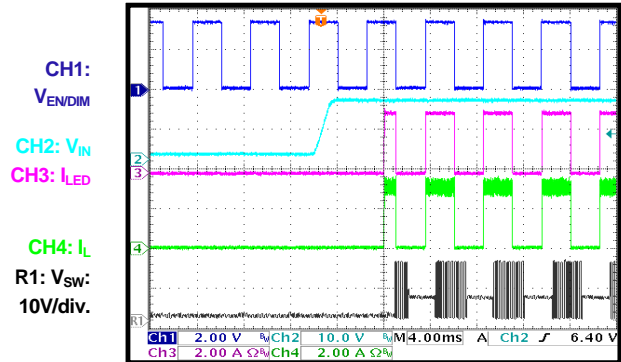

PWM Dimming
Shutdown through VIN

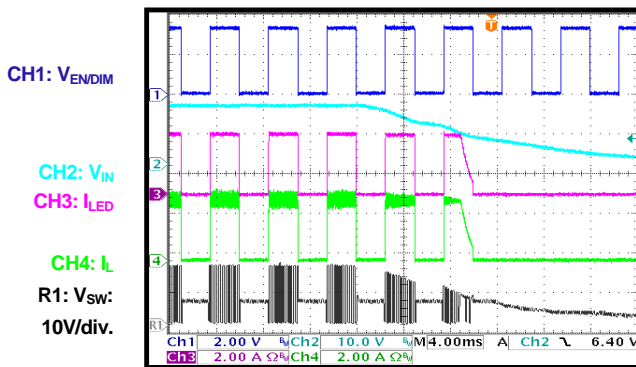

Two-Step Dimming
Steady state

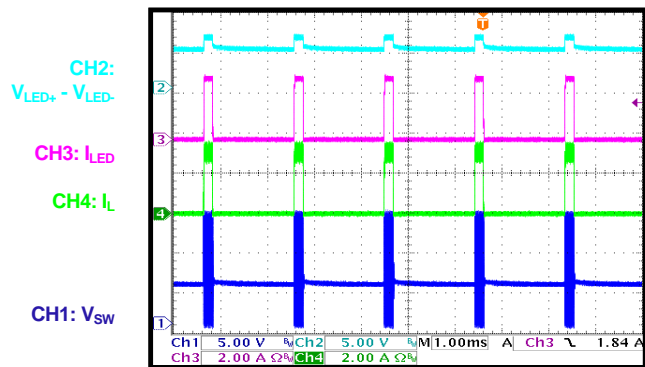

Two-Step Dimming
Start-up through VIN

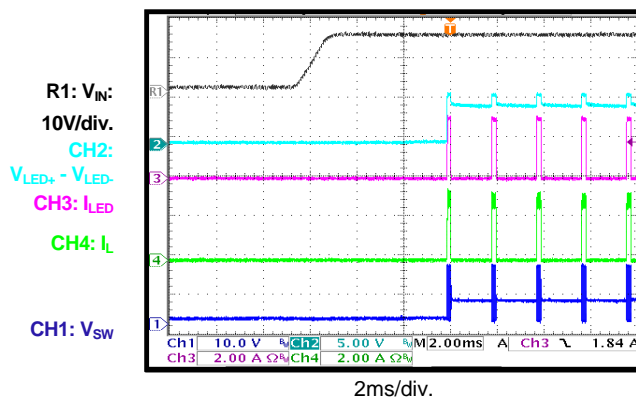

Two-Step Dimming
Shutdown through VIN

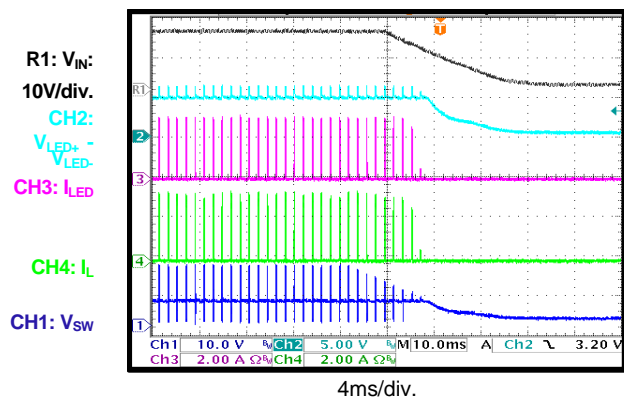

TYPICAL PERFORMANCE CHARACTERISTICS *(continued)*

Buck mode, 2 LEDs ($V_{LED} = 6V$), $V_{IN} = 13.5V$, $I_{LED} = 3A$, $f_{SW} = 410kHz$, $L = 10\mu H$, $T_A = 25^\circ C$, unless otherwise noted.

No Dimming
LED open start-up

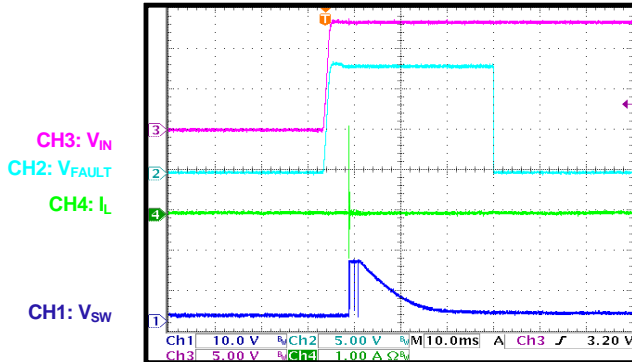

No Dimming
LED open entry

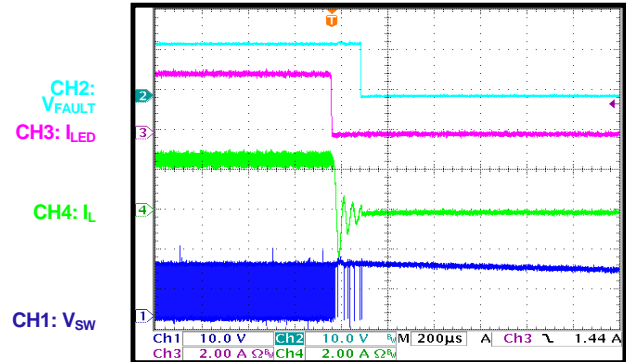

PWM Dimming
LED open start-up

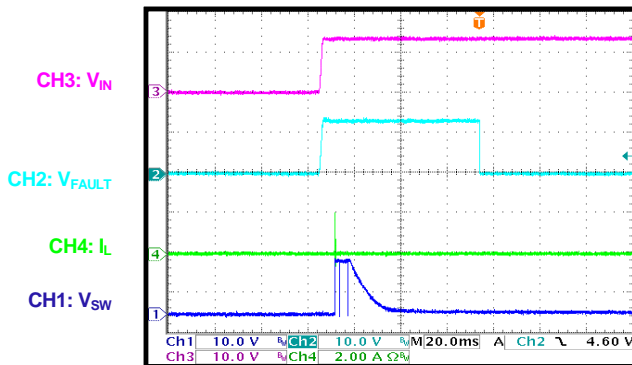

PWM Dimming
LED open entry

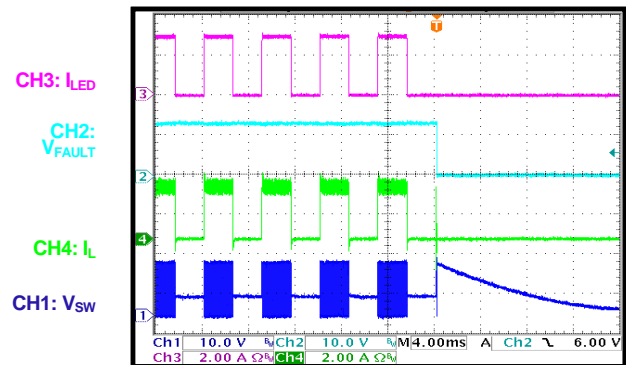

Two-Step Dimming
LED open start-up

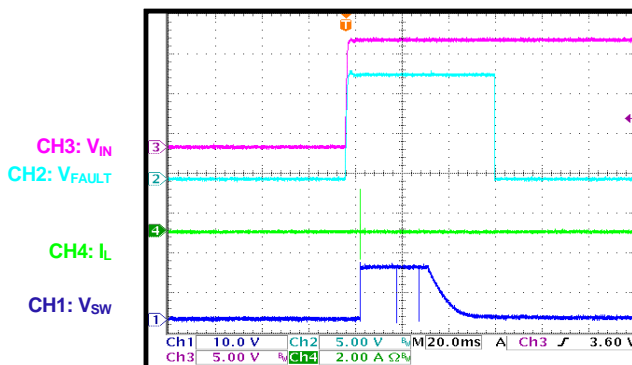

Two-Step Dimming
LED open start-up

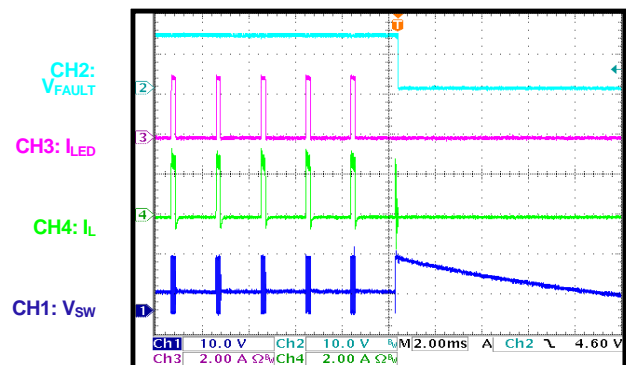

TYPICAL PERFORMANCE CHARACTERISTICS *(continued)*

Buck mode, 2 LEDs ($V_{LED} = 6V$), $V_{IN} = 13.5V$, $I_{LED} = 3A$, $f_{SW} = 410kHz$, $L = 10\mu H$, $T_A = 25^\circ C$, unless otherwise noted.

No Dimming

LED+ short to LED- start-up

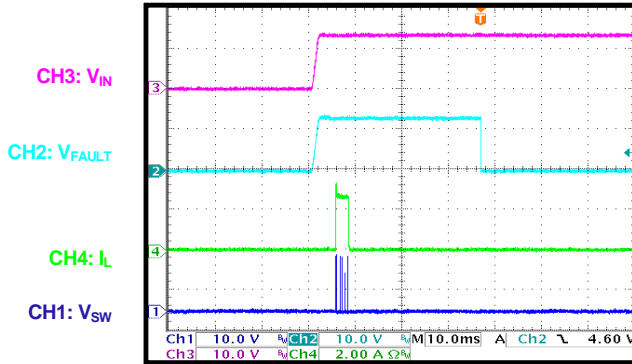

No Dimming

LED+ short to LED- entry

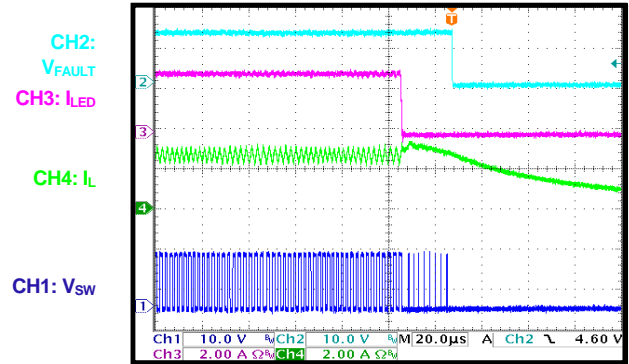

PWM Dimming

LED+ short to LED- start-up

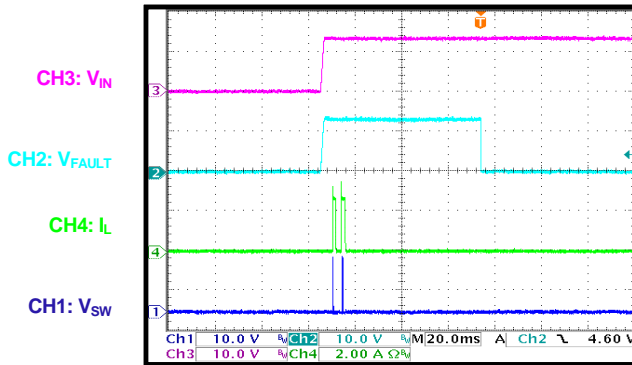

PWM Dimming

LED+ short to LED- entry

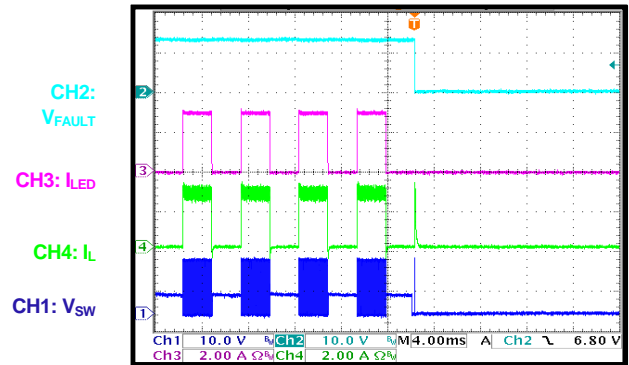

Two-Step Dimming

LED+ short to LED- start-up

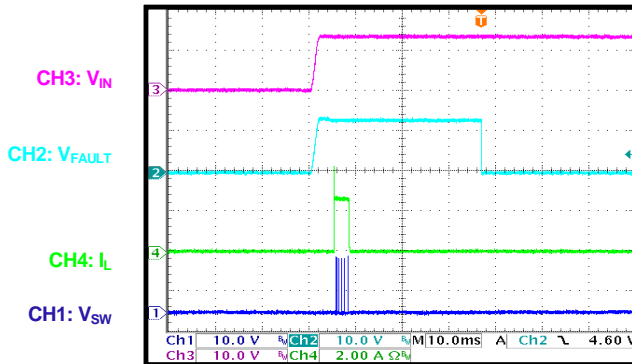

Two-Step Dimming

LED+ short to LED- entry

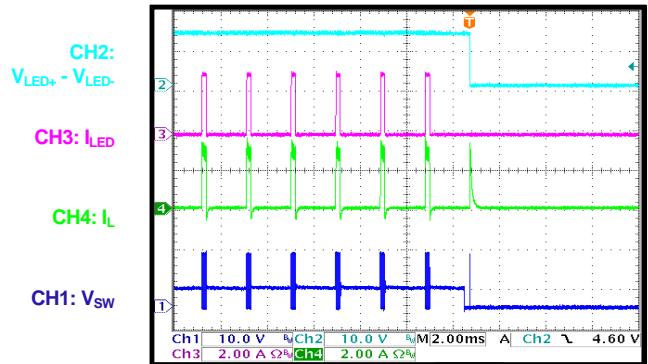

TYPICAL PERFORMANCE CHARACTERISTICS *(continued)*

Buck mode, 2 LEDs ($V_{LED} = 6V$), $V_{IN} = 13.5V$, $I_{LED} = 3A$, $f_{SW} = 410kHz$, $L = 10\mu H$, $T_A = 25^\circ C$, unless otherwise noted.

IREF Short Before Start-Up

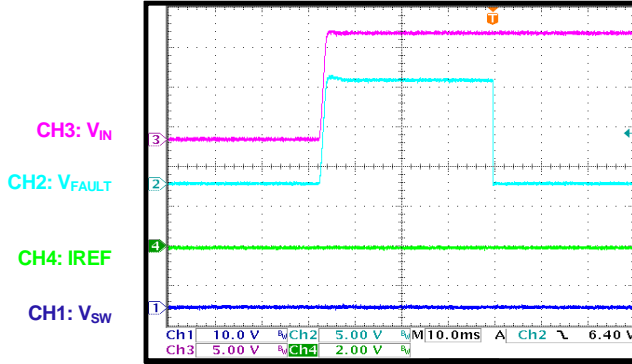

IREF Open Before Start-Up

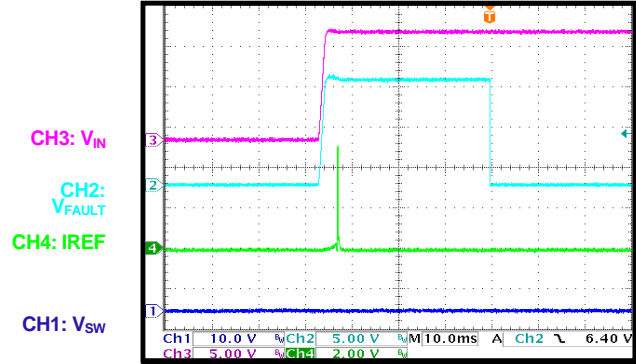

IREF Short after Start-Up

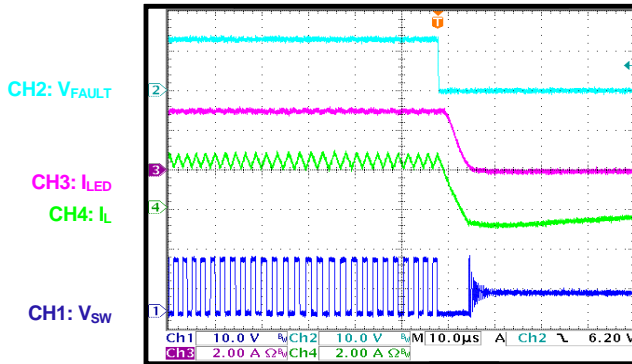

IREF Open after Start-Up

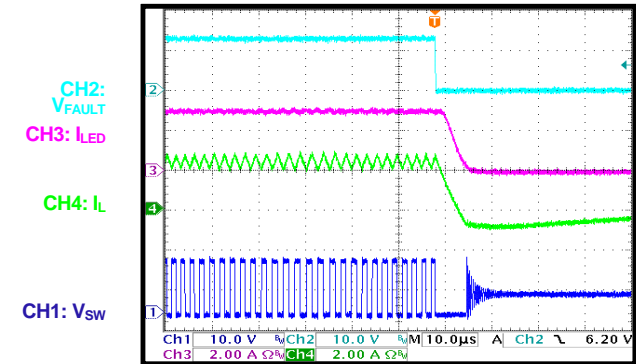

**IREF Short after Start-Up
PWM dimming**

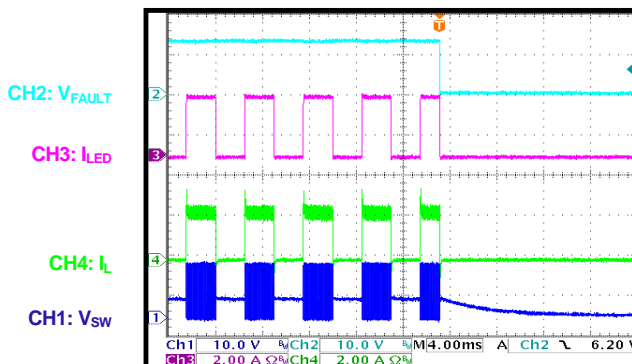

**IREF Open after Start-Up
PWM dimming**

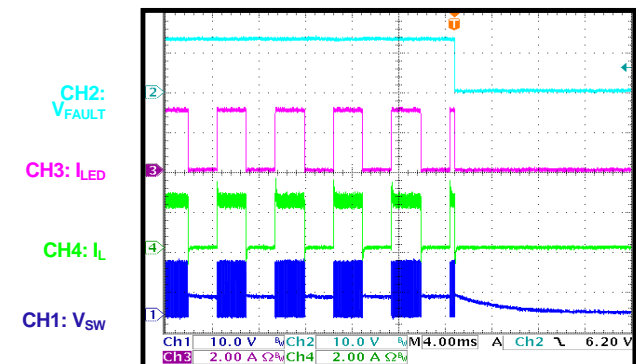

TYPICAL PERFORMANCE CHARACTERISTICS *(continued)*

Buck mode, 2 LEDs ($V_{LED} = 6V$), $V_{IN} = 13.5V$, $I_{LED} = 3A$, $f_{SW} = 410kHz$, $L = 10\mu H$, $T_A = 25^\circ C$, unless otherwise noted.

ISET Short before Start-Up

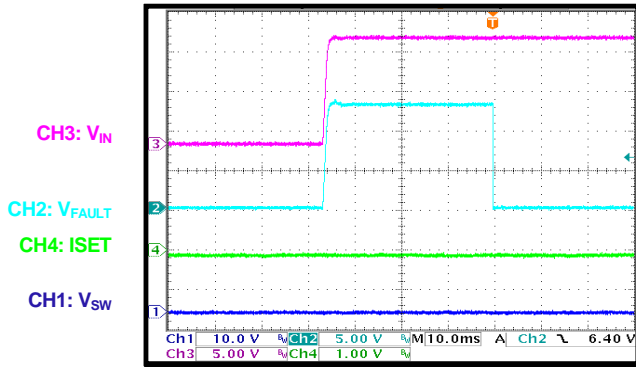

ISET Open before Start-Up

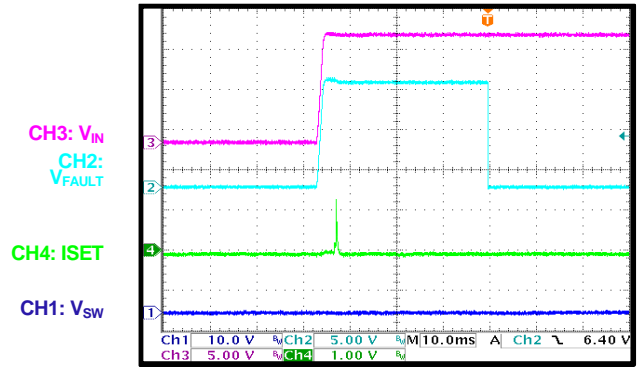

ISET Short after Start-Up

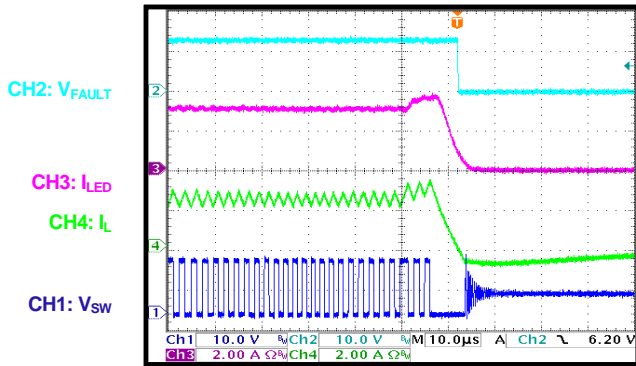

ISET Open after Start-Up

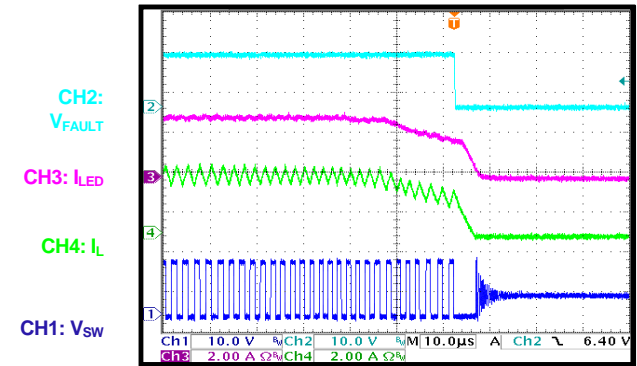

ISET Short after Start-Up

PWM dimming

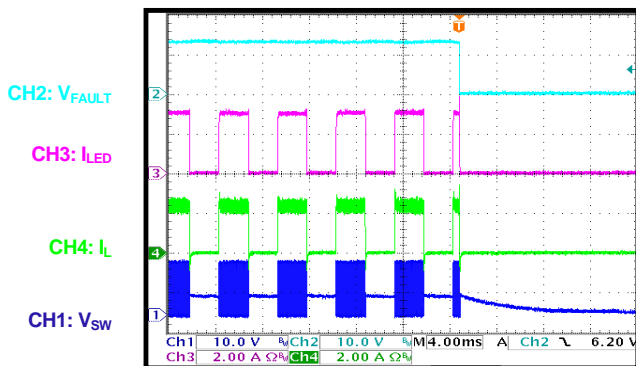

ISET Open after Start-Up

PWM dimming

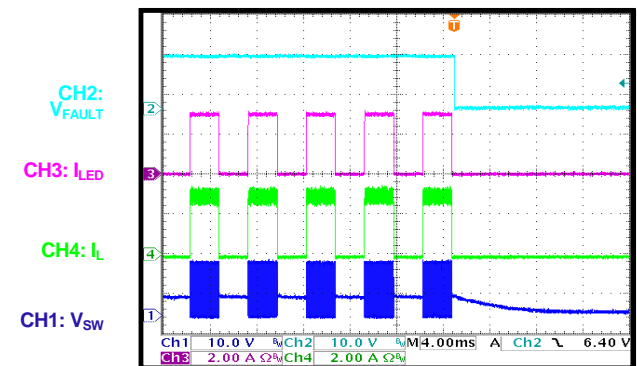

TYPICAL PERFORMANCE CHARACTERISTICS *(continued)*

Buck mode, 2 LEDs ($V_{LED} = 6V$), $V_{IN} = 13.5V$, $I_{LED} = 3A$, $f_{SW} = 410kHz$, $L = 10\mu H$, $T_A = 25^\circ C$, unless otherwise noted.

DUTY Short before Start-Up

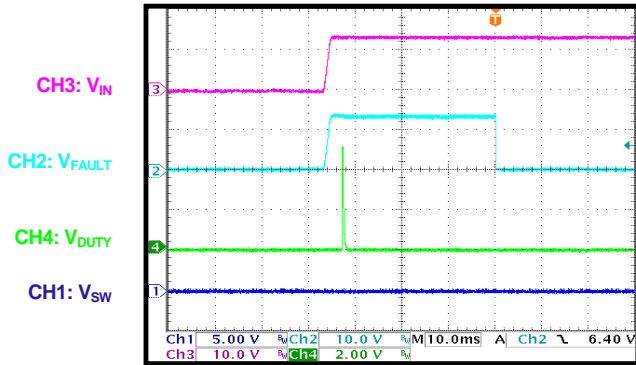

DUTY Open before Start-Up

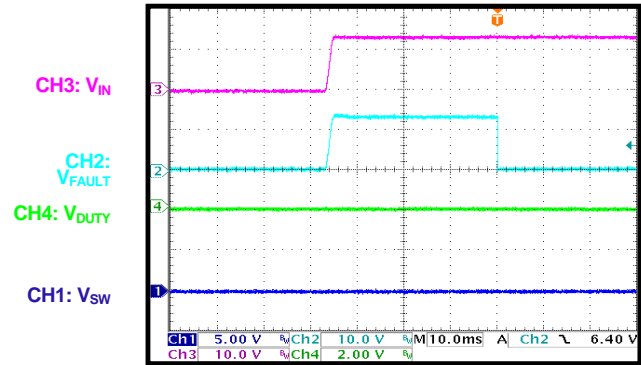

FAULT Short during VIN Start Up

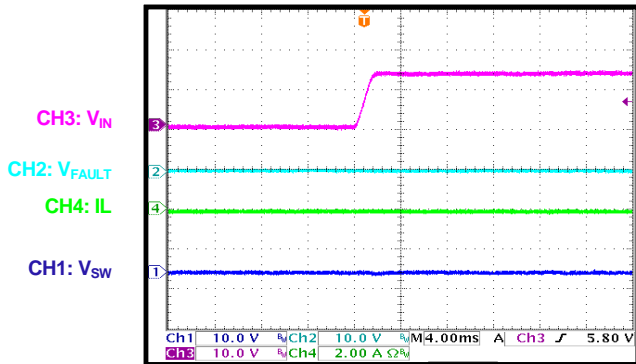

FAULT Short after VIN Start-Up

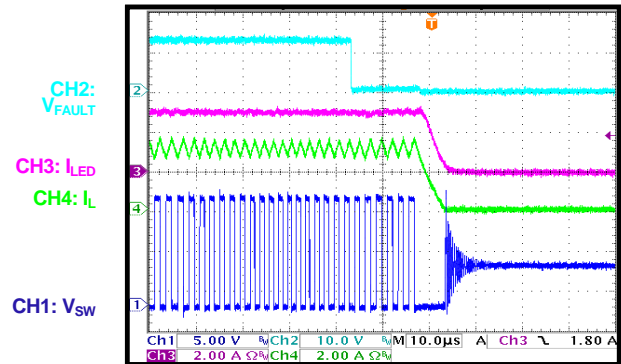

Incorrect Mode Detection during VIN Start-Up

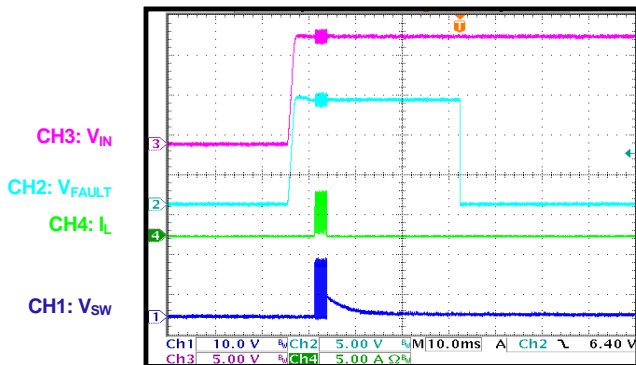

TYPICAL PERFORMANCE CHARACTERISTICS *(continued)*

Buck-boost mode, 4 LEDs ($V_{LED} = 12V$), $V_{IN} = 13.5V$, $I_{LED} = 1.2A$, $f_{SW} = 410kHz$, $L = 10\mu H$, $T_A = 25^\circ C$, unless otherwise noted.

I_{LED} Part to Part Variation

$T_J = 25^\circ C$ to $+100^\circ C$

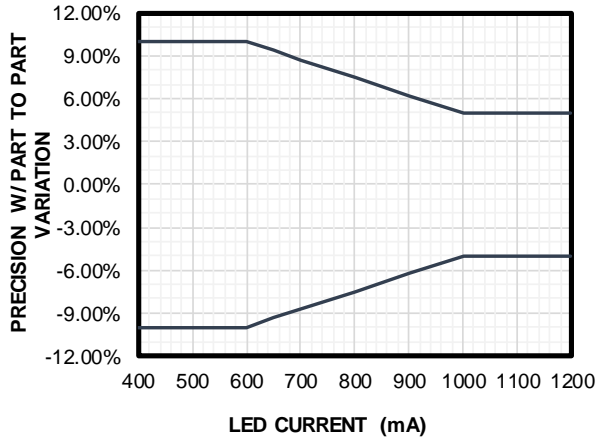

I_{LED} Part to Part Variation

$T_J = -40^\circ C$ to $+150^\circ C$

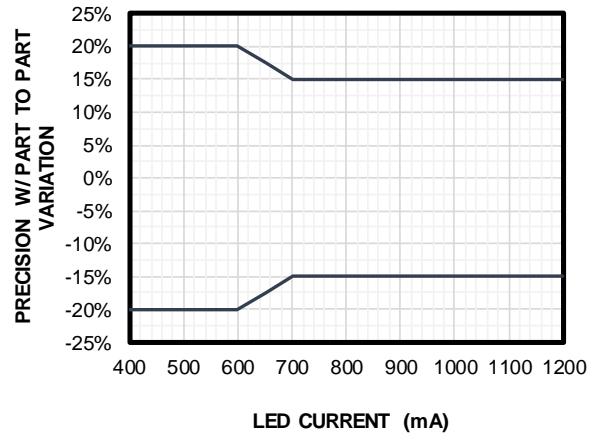

I_{LED} Precision vs. Input Voltage

$L = 10\mu H$, $I_{LED} = 1.2A$, V_{IN} ramping up

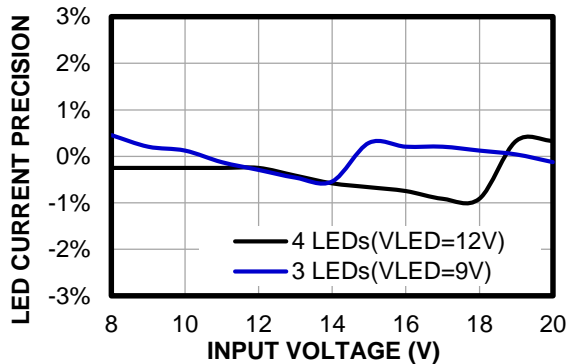

I_{LED} Precision vs. Input Voltage

$L = 10\mu H$, $I_{LED} = 1.2A$, V_{IN} ramping down

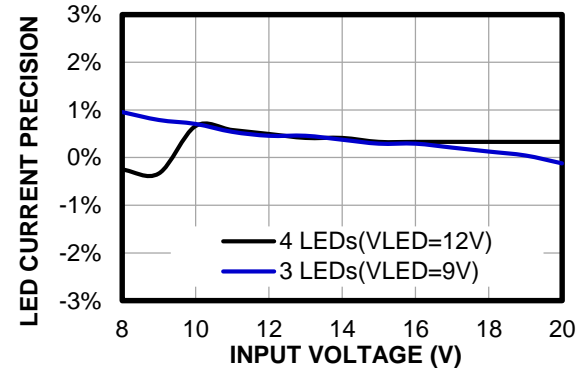

I_{LED} Precision vs. Input Voltage

$L = 10\mu H$, $I_{LED} = 1A$, V_{IN} ramping up

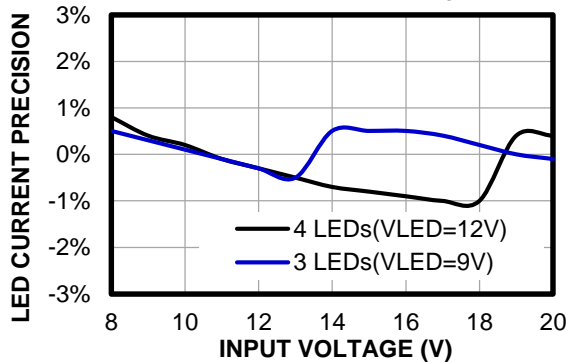

I_{LED} Precision vs. Input Voltage

$L = 10\mu H$, $I_{LED} = 1A$, V_{IN} ramping down

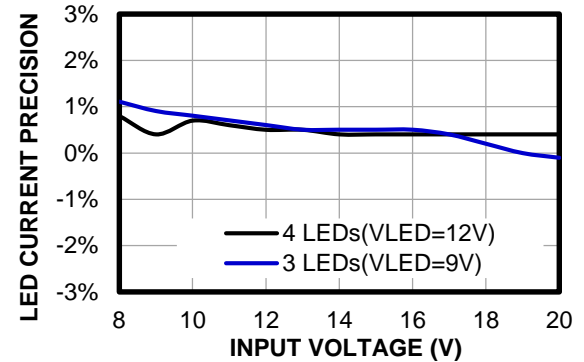

TYPICAL PERFORMANCE CHARACTERISTICS *(continued)*

Buck-boost mode, 4 LEDs ($V_{LED} = 12V$), $V_{IN} = 13.5V$, $I_{LED} = 1.2A$, $f_{SW} = 410kHz$, $L = 10\mu H$, $T_A = 25^\circ C$, unless otherwise noted.

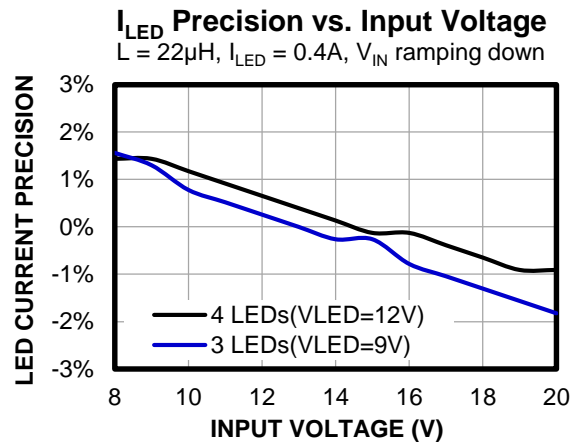
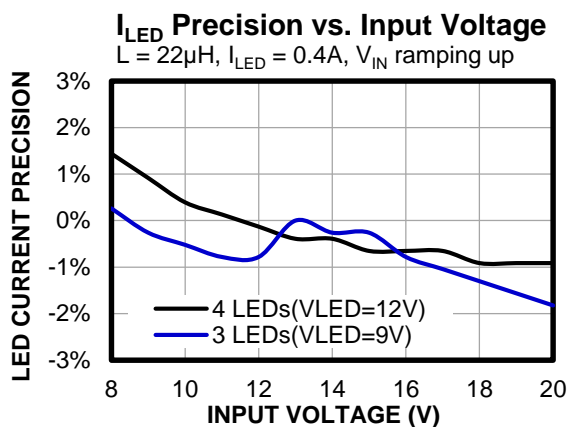
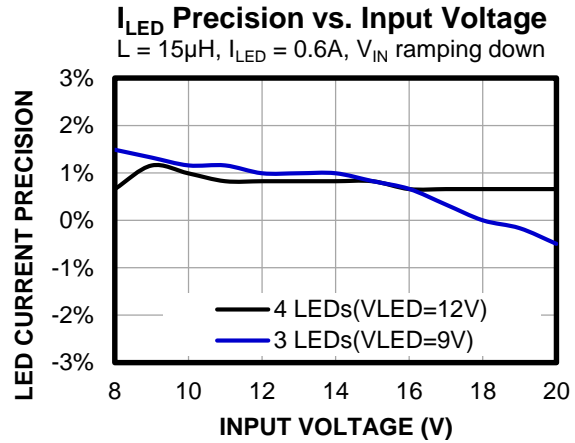
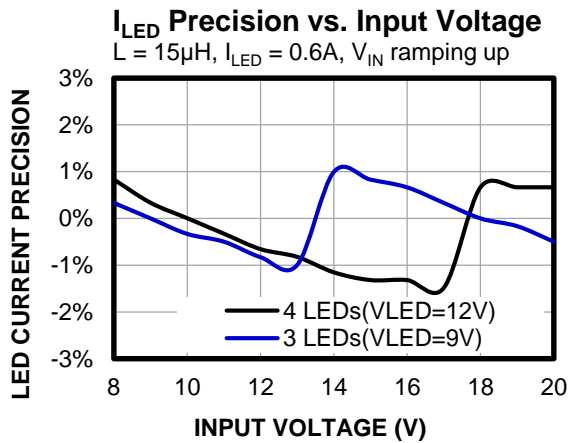
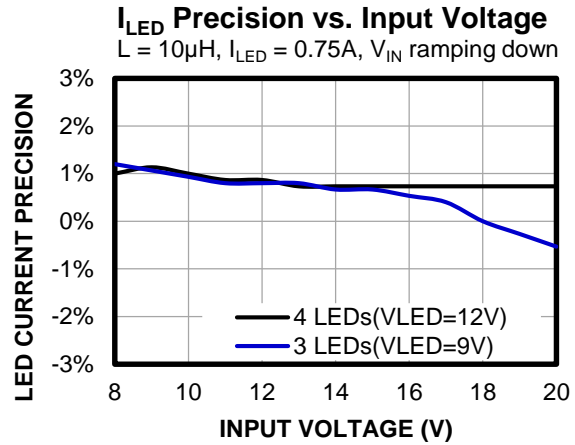
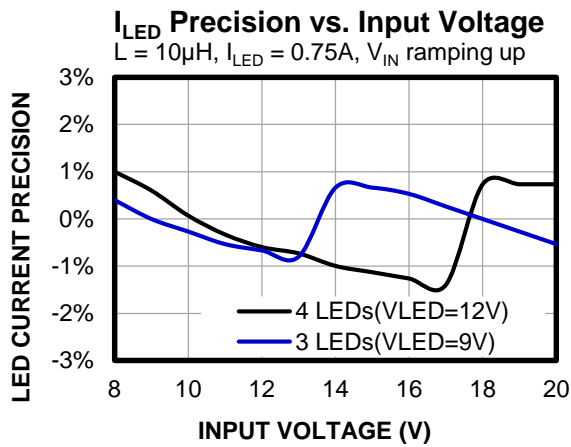

TYPICAL PERFORMANCE CHARACTERISTICS *(continued)*

Buck-boost mode, 4 LEDs ($V_{LED} = 12V$), $V_{IN} = 13.5V$, $I_{LED} = 1.2A$, $f_{SW} = 410kHz$, $L = 10\mu H$, $T_A = 25^\circ C$, unless otherwise noted.

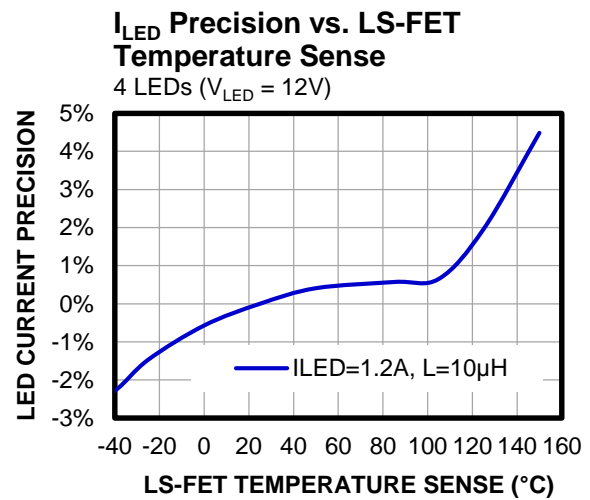
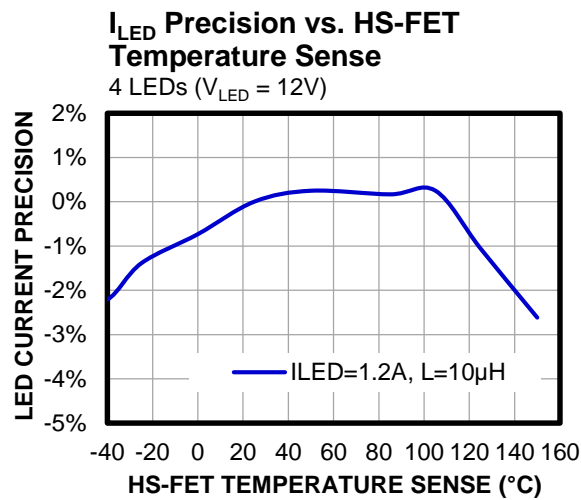
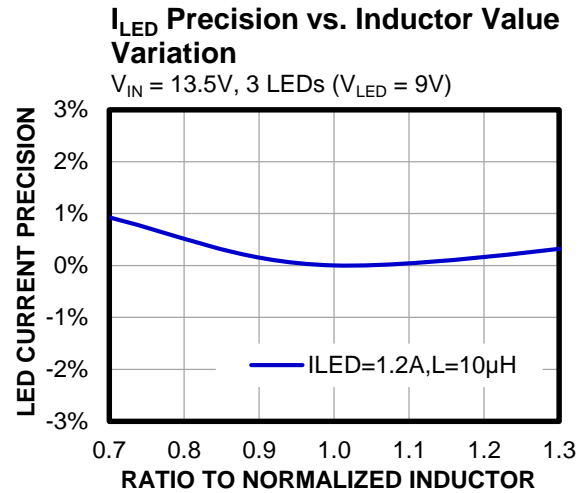
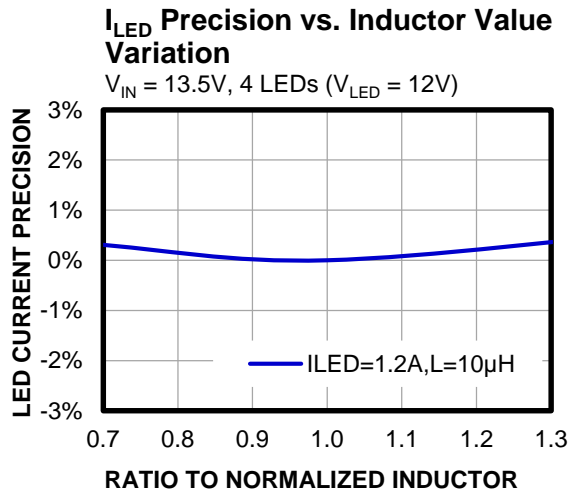

V_{IN} Slow Ramp Up and Down
 4 LEDs ($V_{LED} = 12V$), $I_{LED} = 1.2A$, $V_{IN} = 0V$ to 20V, 0.001V/ms

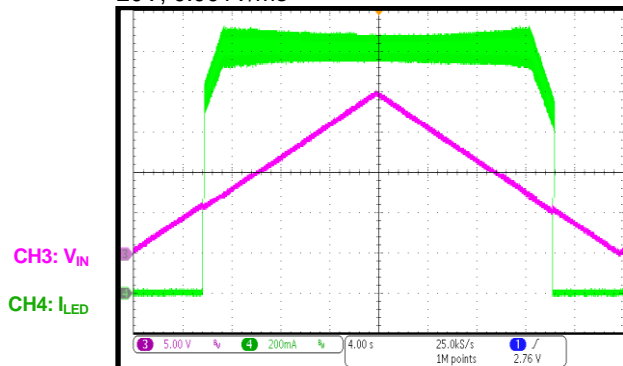

V_{IN} Slow Ramp Up and Down
 3 LEDs ($V_{LED} = 9V$), $I_{LED} = 1.2A$, $V_{IN} = 0V$ to 20V, 0.001V/ms

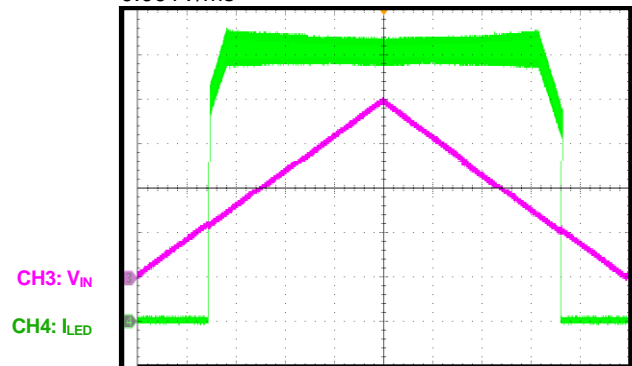

TYPICAL PERFORMANCE CHARACTERISTICS *(continued)*

Buck-boost mode, $V_{IN} = 12V$, 4 LEDs in series ($V_{LED} = 12V$), $I_{LED} = 1.2A$, $L = 10\mu H$, $f_{SW} = 410kHz$, with EMI filters, $T_A = 25^\circ C$, unless otherwise noted. ⁽¹⁰⁾

CISPR25 Class 5 Peak Conducted Emissions

150kHz to 108MHz

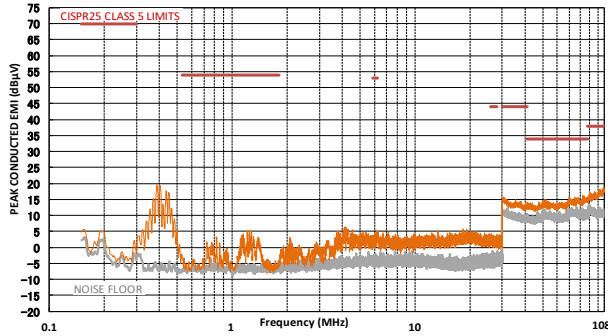

CISPR25 Class 5 Average Conducted Emissions

150kHz to 108MHz

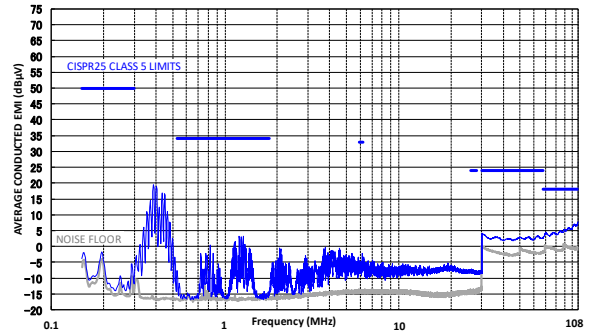

CISPR25 Class 5 Peak Radiated Emissions

150kHz to 30MHz

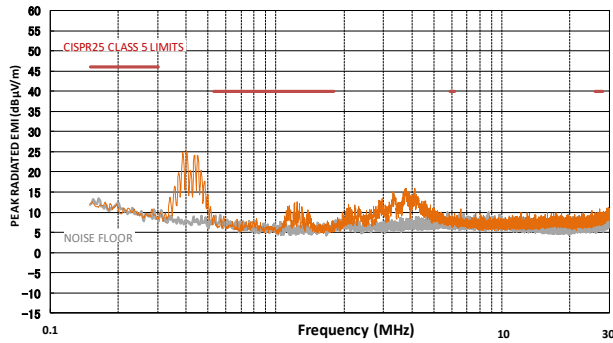

CISPR25 Class 5 Average Radiated Emissions

150kHz to 30MHz

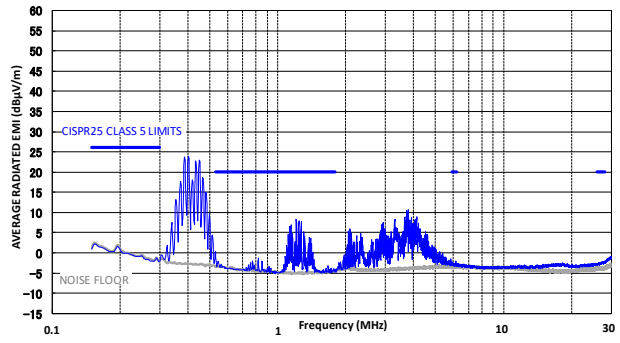

CISPR25 Class 5 Peak Radiated Emissions

Horizontal, 30MHz to 200MHz

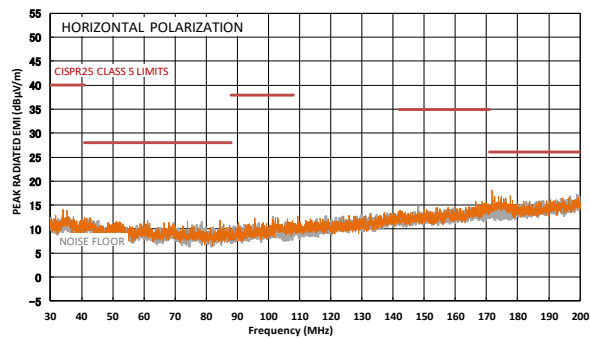

CISPR25 Class 5 Average Radiated Emissions

Horizontal, 30MHz to 200MHz

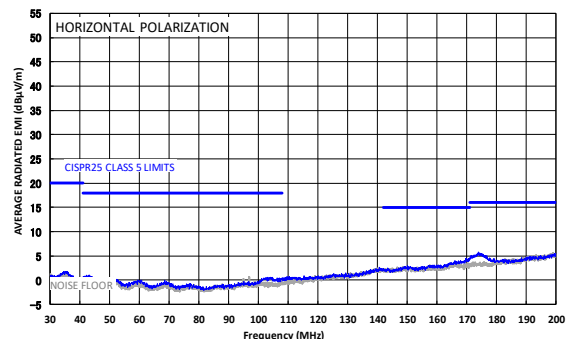

TYPICAL PERFORMANCE CHARACTERISTICS *(continued)*

Buck-boost mode, $V_{IN} = 12V$, 4 LEDs in series ($V_{LED} = 12V$), $I_{LED} = 1.2A$, $L = 10\mu H$, $f_{SW} = 410kHz$, with EMI filters, $T_A = 25^\circ C$, unless otherwise noted. ⁽¹⁰⁾

CISPR25 Class 5 Peak Radiated Emissions

Vertical, 30MHz to 200MHz

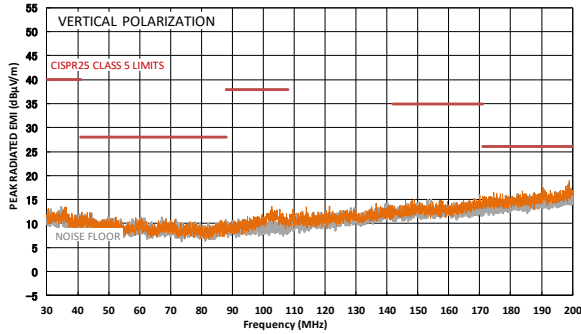

CISPR25 Class 5 Average Radiated Emissions

Vertical, 30MHz to 200MHz

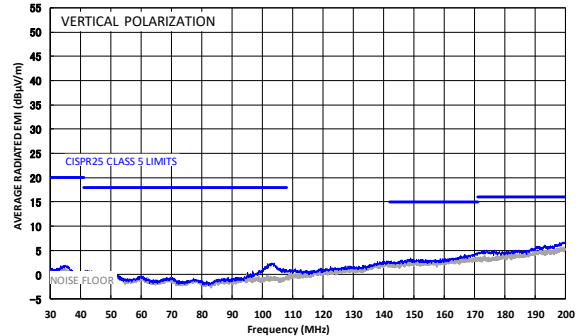

CISPR25 Class 5 Peak Radiated Emissions

Horizontal, 200MHz to 1GHz

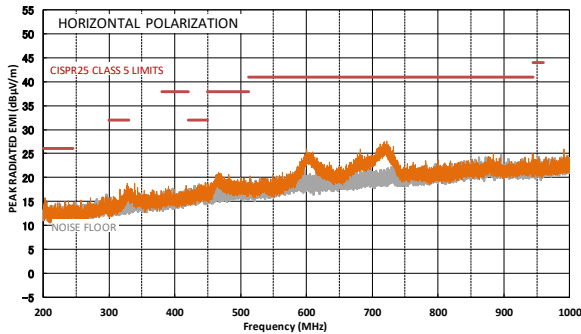

CISPR25 Class 5 Average Radiated Emissions

Horizontal, 200MHz to 1GHz

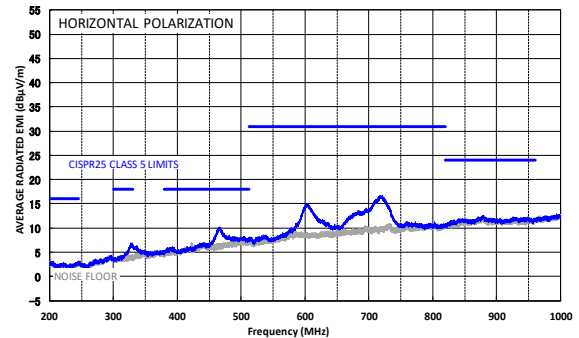

CISPR25 Class 5 Peak Radiated Emissions

Vertical, 200MHz to 1GHz

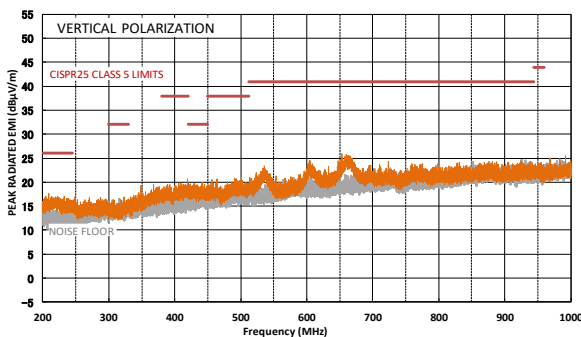

CISPR25 Class 5 Average Radiated Emissions

Vertical, 200MHz to 1GHz

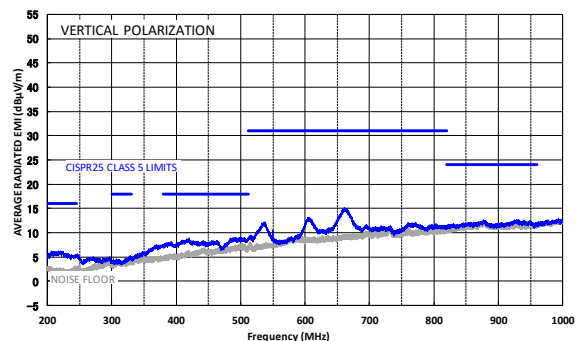

Notes:

10) The MPQ7200A buck-boost mode EMC test results are based on the application circuit with EMI filters as shown in Figure 10 on page 54.

TYPICAL PERFORMANCE CHARACTERISTICS (continued)⁽¹¹⁾

Buck-boost mode, 4 LEDs ($V_{LED} = 12V$), $V_{IN} = 13.5V$, $I_{LED} = 1.2A$, $f_{SW} = 410kHz$, $L = 10\mu H$, $T_A = 25^\circ C$, unless otherwise noted.

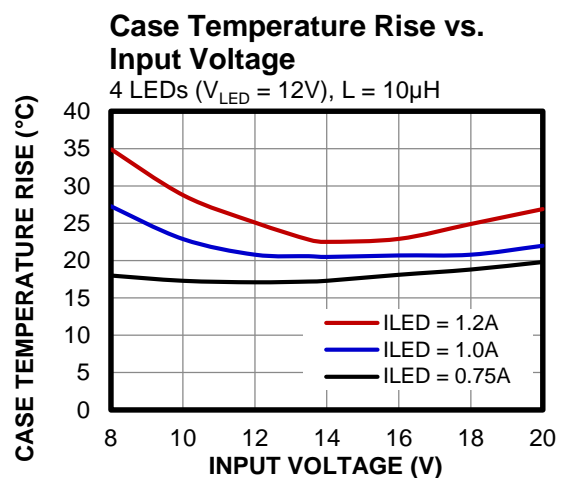
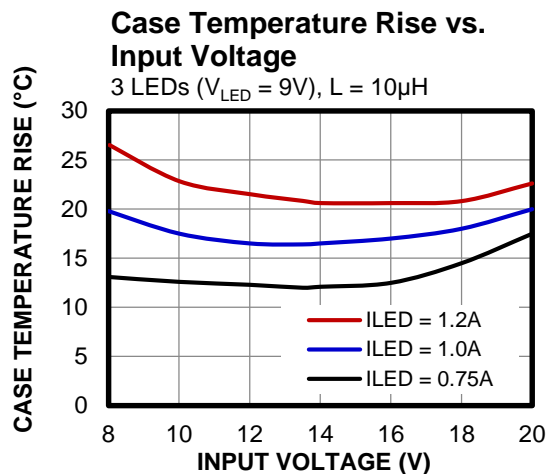
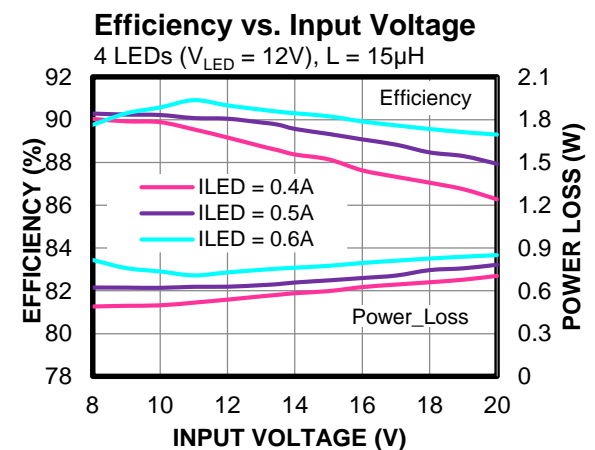
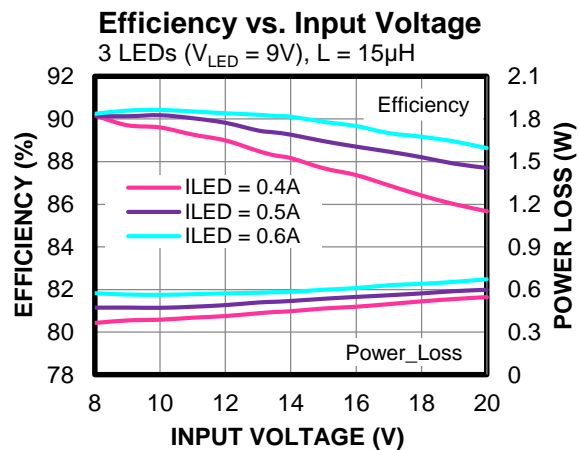
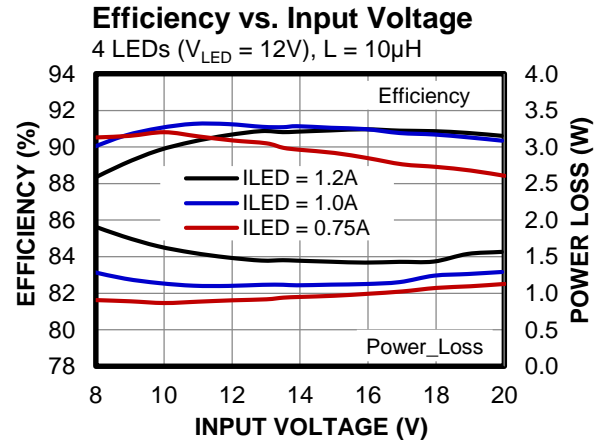
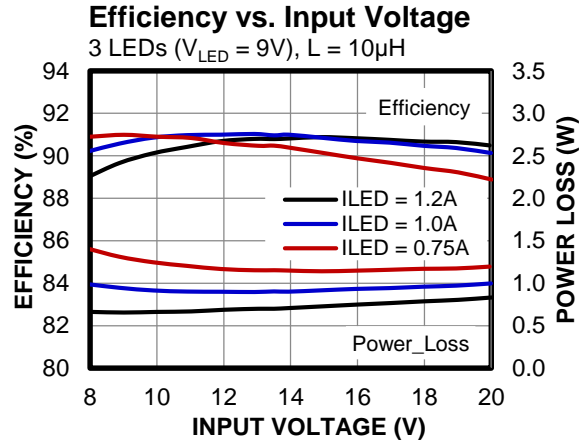

Note:

11) The efficiency and thermal curve is based on Figure 10, but $R_{BST} = 0\Omega$, and remove the input and output filters. $L = 10\mu H$: VCHA075D-100MS6; $L = 15\mu H$: XAL4040-153MEB.

TYPICAL PERFORMANCE CHARACTERISTICS (continued)

Buck-boost mode, 4 LEDs ($V_{LED} = 12V$), $V_{IN} = 13.5V$, $I_{LED} = 1.2A$, $f_{SW} = 410kHz$, $L = 10\mu H$, $T_A = 25^\circ C$, unless otherwise noted.

Steady State

$I_{LED} = 1.2A$

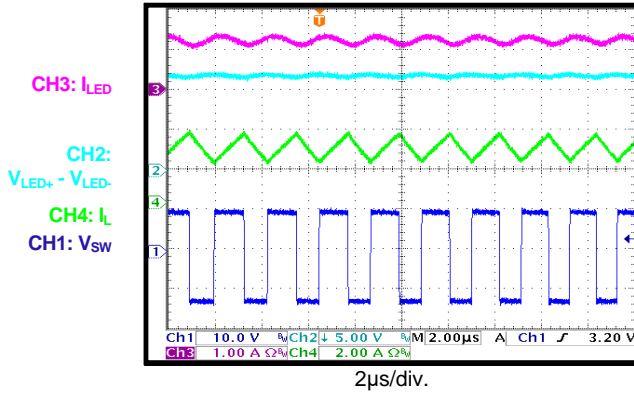

Start-Up through VIN

$I_{LED} = 1.2A$

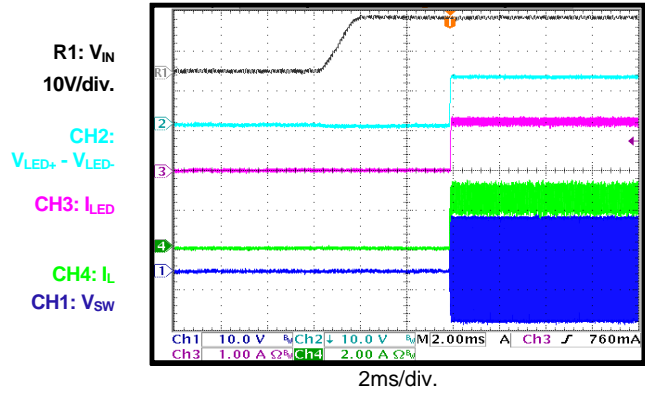

Shutdown through VIN

$I_{LED} = 1.2A$

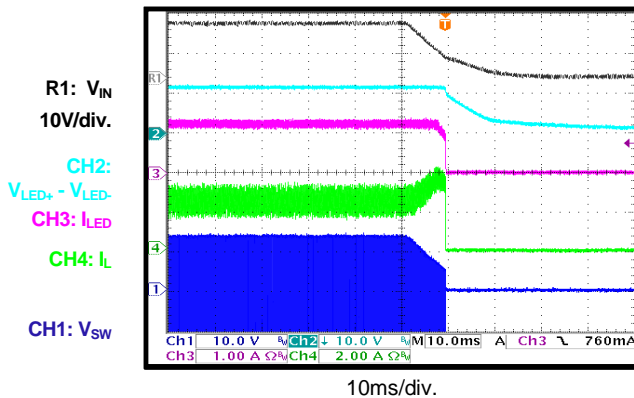

Start-Up through EN

$I_{LED} = 1.2A$

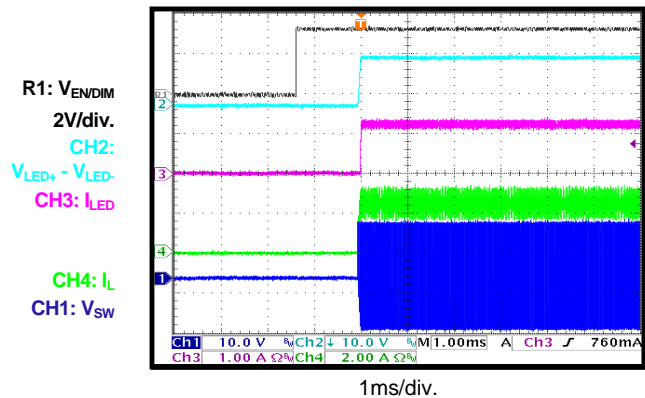

Shutdown through EN

$I_{LED} = 1.2A$

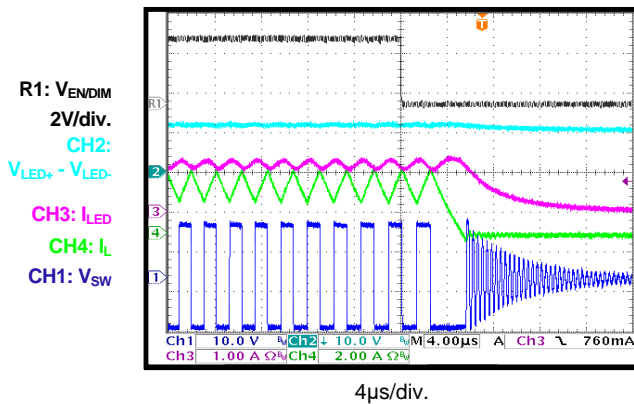

PWM Dimming Steady State

Dimming frequency = 100Hz

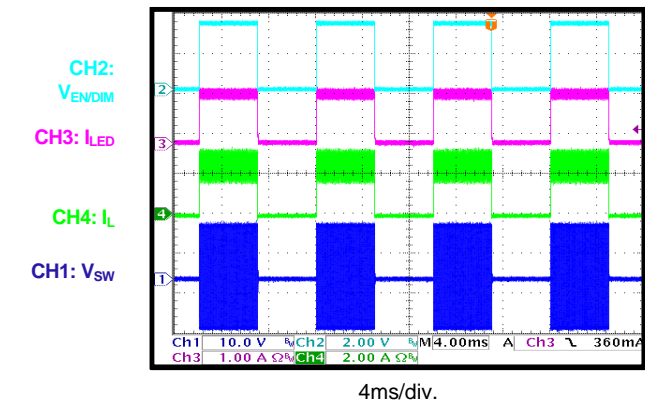

TYPICAL PERFORMANCE CHARACTERISTICS *(continued)*

Buck-boost mode, 4 LEDs ($V_{LED} = 12V$), $V_{IN} = 13.5V$, $I_{LED} = 1.2A$, $f_{SW} = 410kHz$, $L = 10\mu H$, $T_A = 25^\circ C$, unless otherwise noted.

PWM Dimming Steady State

Dimming frequency = 2kHz

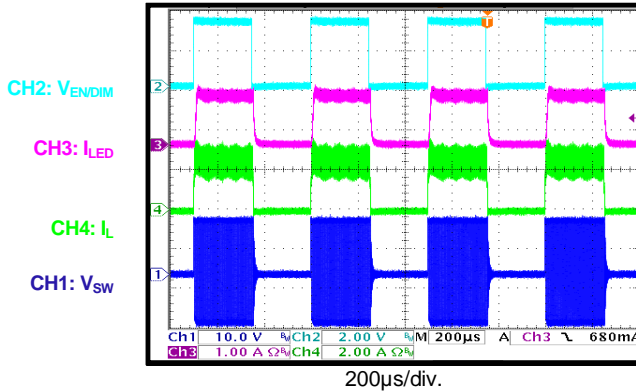

PWM Dimming

Start-up through VIN

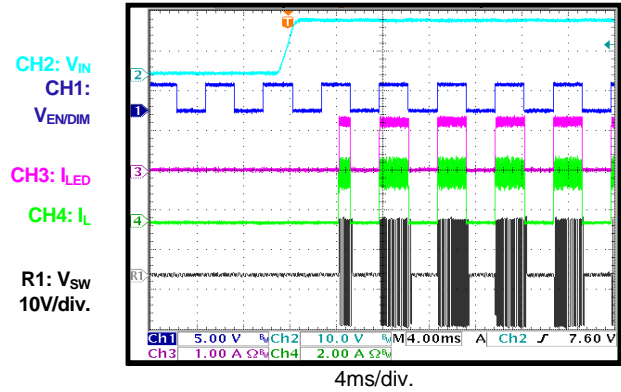

PWM Dimming

Shutdown through VIN

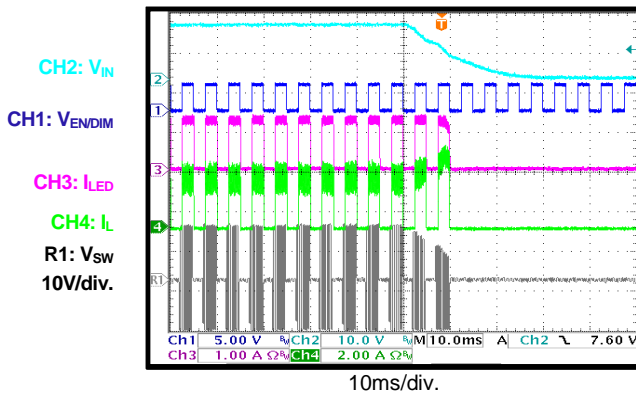

Two-Step Dimming

Steady state

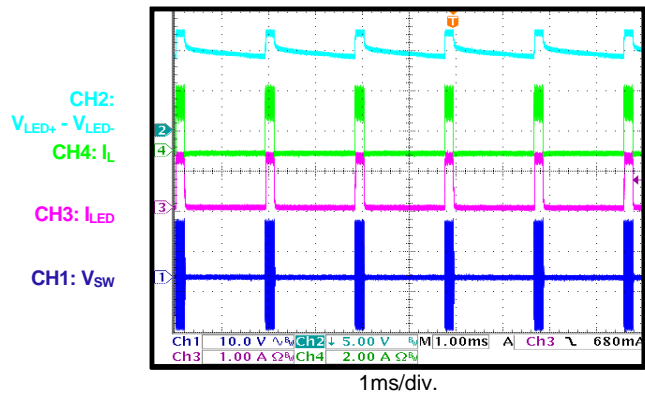

Two-Step Dimming

Start-up through VIN

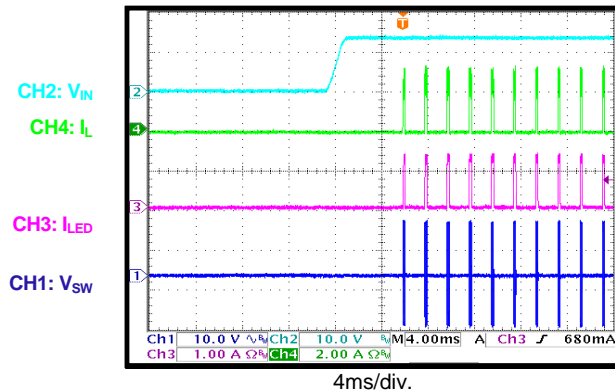

Two-Step Dimming

Shutdown through VIN

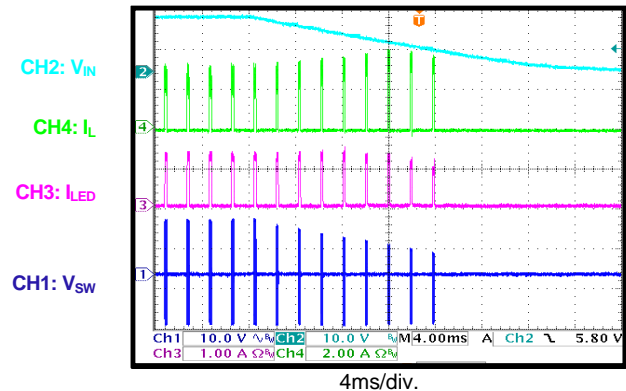

TYPICAL PERFORMANCE CHARACTERISTICS (continued)

Buck-boost mode, 4 LEDs ($V_{LED} = 12V$), $V_{IN} = 13.5V$, $I_{LED} = 1.2A$, $f_{SW} = 410kHz$, $L = 10\mu H$, $T_A = 25^\circ C$, unless otherwise noted.

No Dimming
LED open during V_{IN} start-up

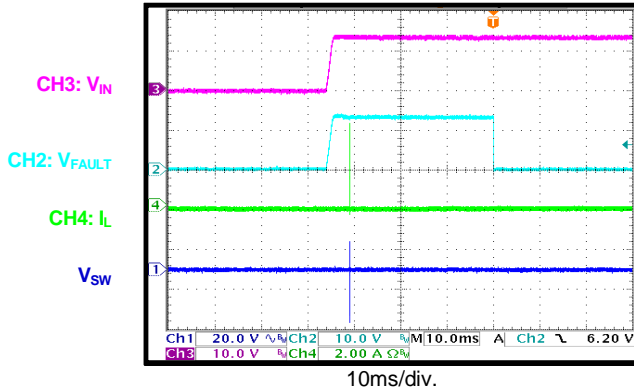

No Dimming
LED open entry

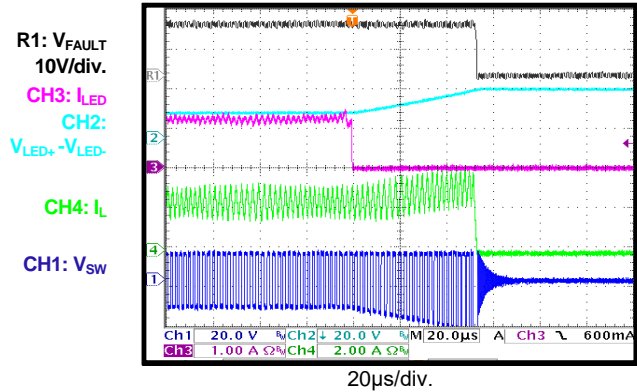

PWM Dimming
LED open during V_{IN} start-up

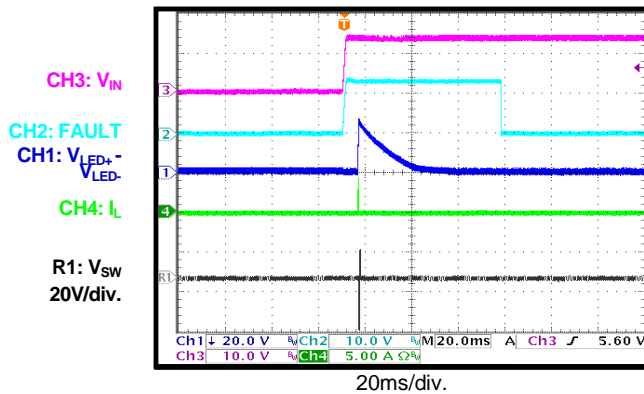

PWM Dimming
LED open entry

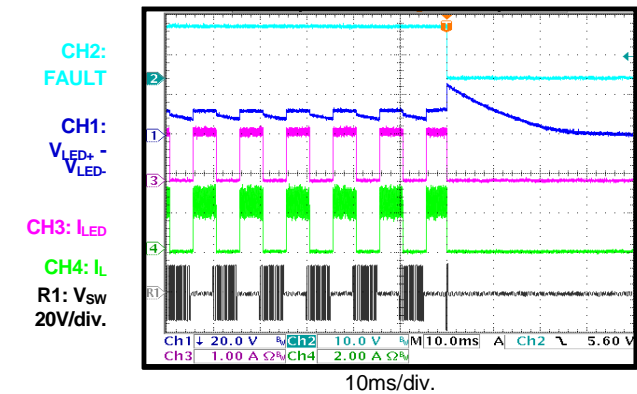

Two-Step Dimming
LED open during V_{IN} start-up

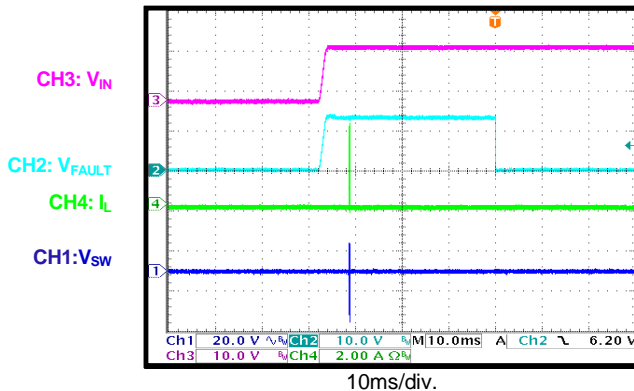

Two-Step Dimming
LED open entry

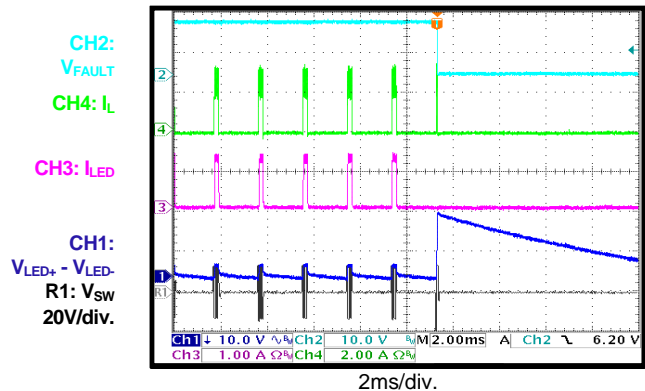

TYPICAL PERFORMANCE CHARACTERISTICS (continued)

Buck-boost mode, 4 LEDs ($V_{LED} = 12V$), $V_{IN} = 13.5V$, $I_{LED} = 1.2A$, $f_{SW} = 410kHz$, $L = 10\mu H$, $T_A = 25^\circ C$, unless otherwise noted.

No-Dimming

LED+ short to LED- during VIN start-up

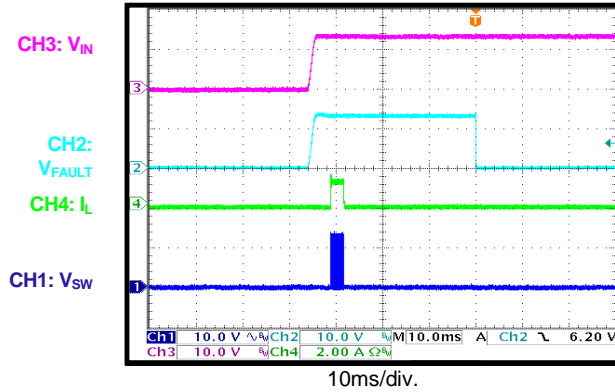

No-Dimming

LED+ short to LED- entry

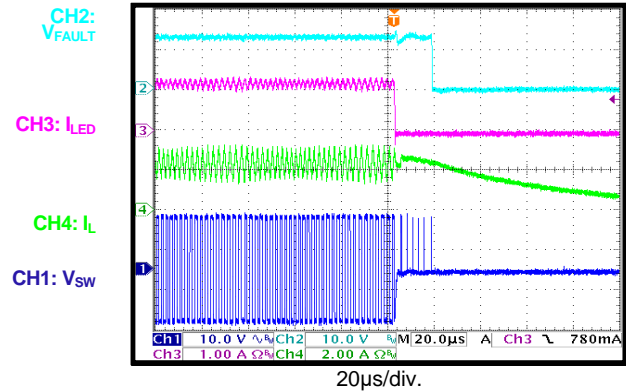

PWM Dimming

LED+ short to LED- during VIN start-up

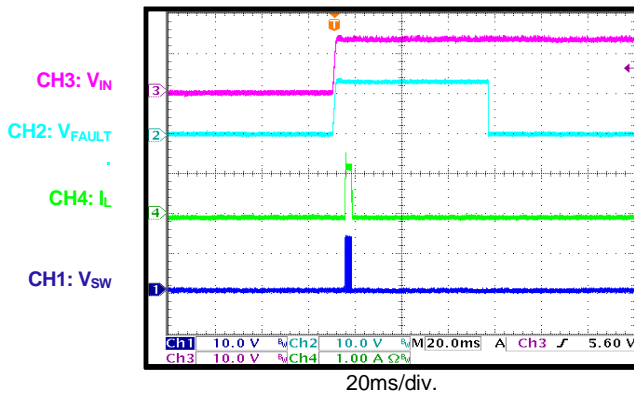

PWM Dimming

LED+ short to LED- entry

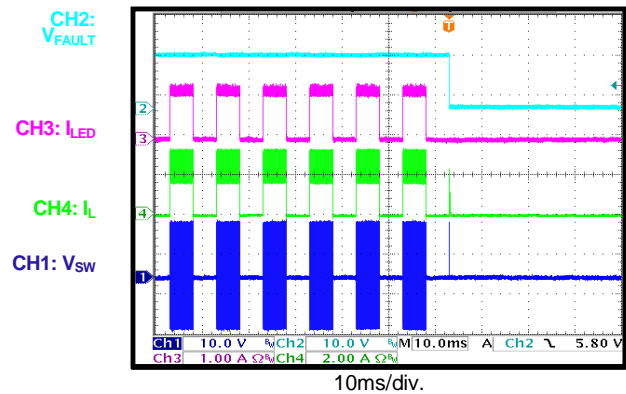

Two-Step Dimming

LED+ short to LED- during VIN start-up

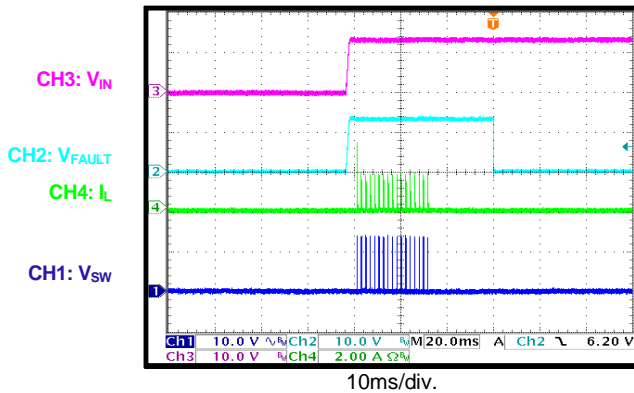

Two-Step Dimming

LED+ short to LED- entry

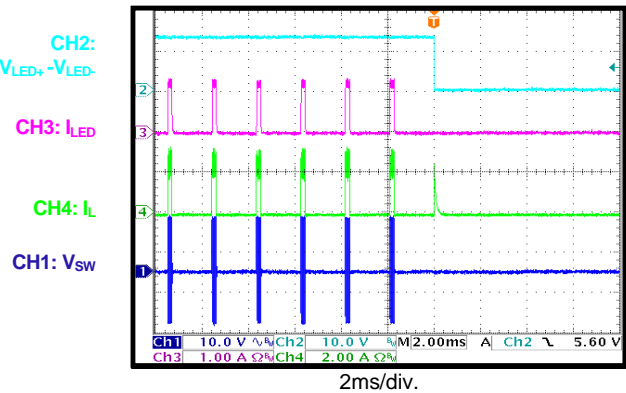

TYPICAL PERFORMANCE CHARACTERISTICS *(continued)*

Buck-boost mode, 4 LEDs ($V_{LED} = 12V$), $V_{IN} = 13.5V$, $I_{LED} = 1.2A$, $f_{SW} = 410kHz$, $L = 10\mu H$, $T_A = 25^\circ C$, unless otherwise noted.

IREF Short before VIN Start-Up

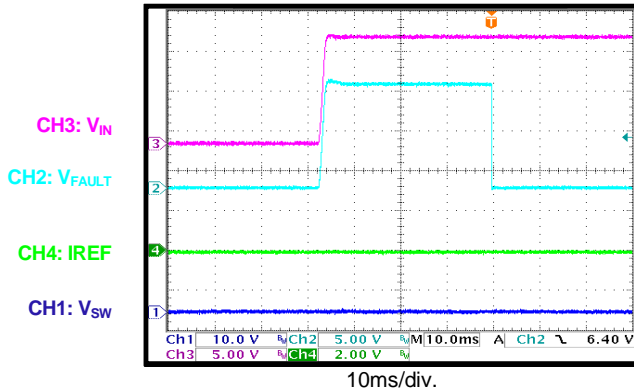

IREF Open before VIN Start-Up

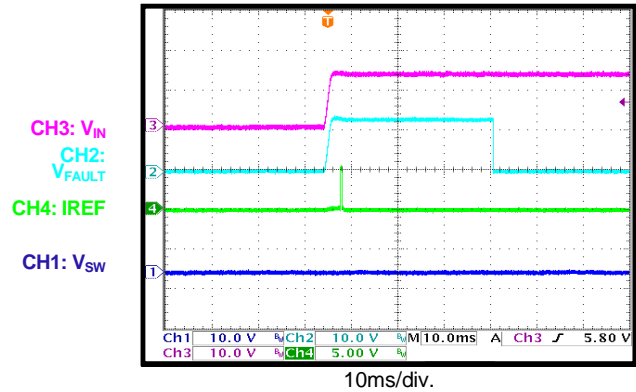

IREF Short after VIN Start-Up

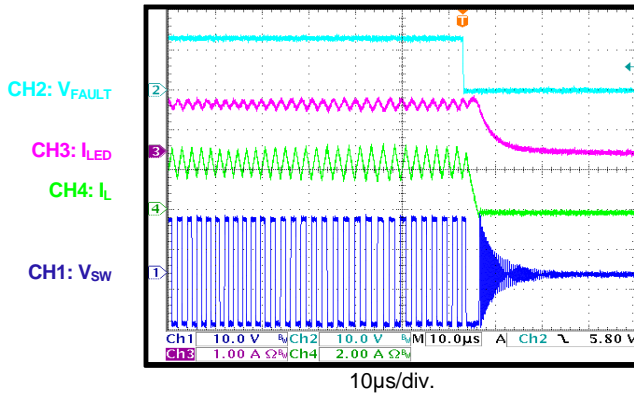

IREF Open after VIN Start-Up

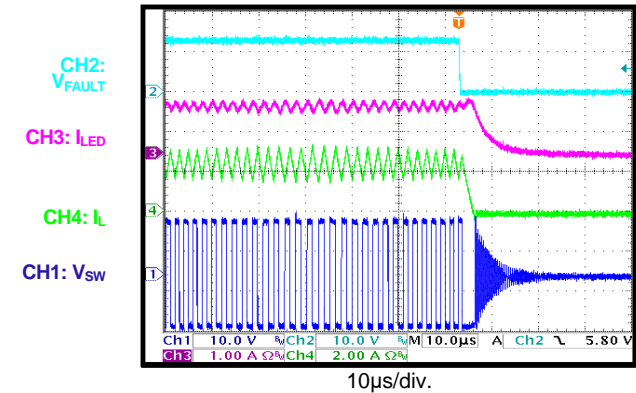

IREF Short after VIN Start-Up

PWM dimming

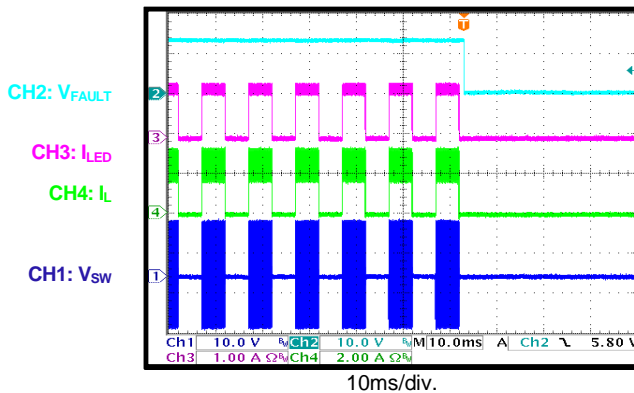

IREF Open after VIN Start-Up

PWM dimming

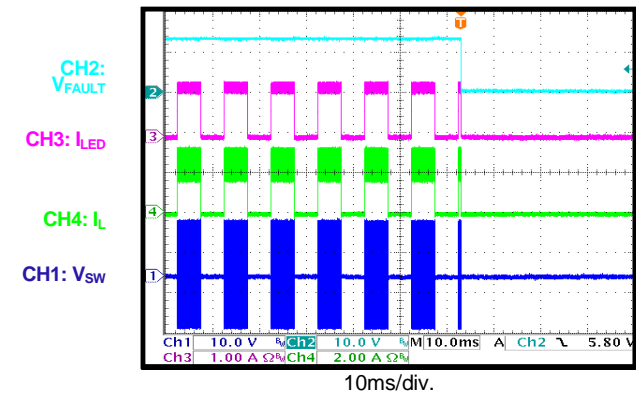

TYPICAL PERFORMANCE CHARACTERISTICS *(continued)*

Buck-boost mode, 4 LEDs ($V_{LED} = 12V$), $V_{IN} = 13.5V$, $I_{LED} = 1.2A$, $f_{SW} = 410kHz$, $L = 10\mu H$, $T_A = 25^\circ C$, unless otherwise noted.

ISET Short before VIN Start-Up

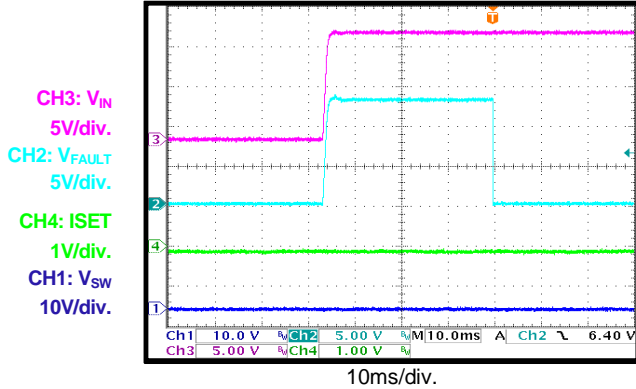

ISET Open before VIN Start-Up

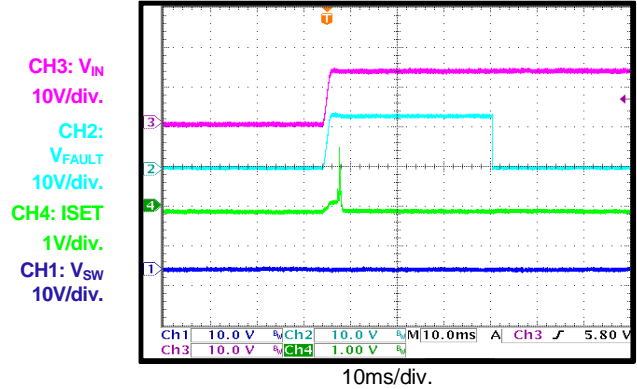

ISET Short after VIN Start-Up

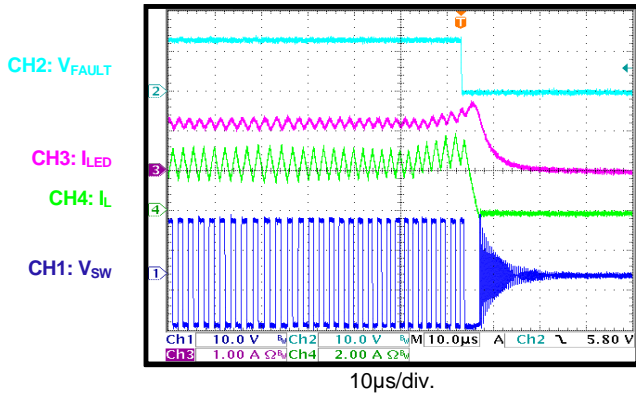

ISET Open after VIN Start-Up

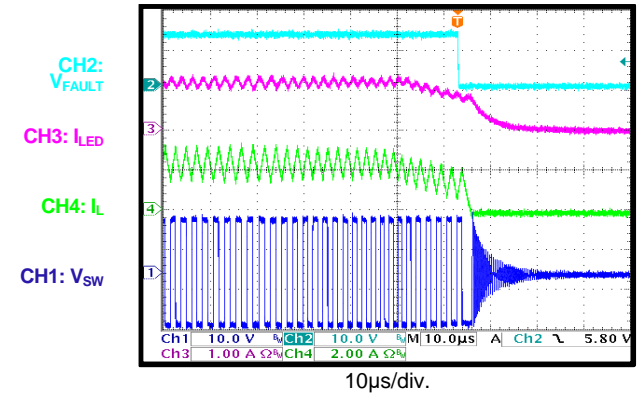

ISET Short after VIN Start-Up

PWM dimming

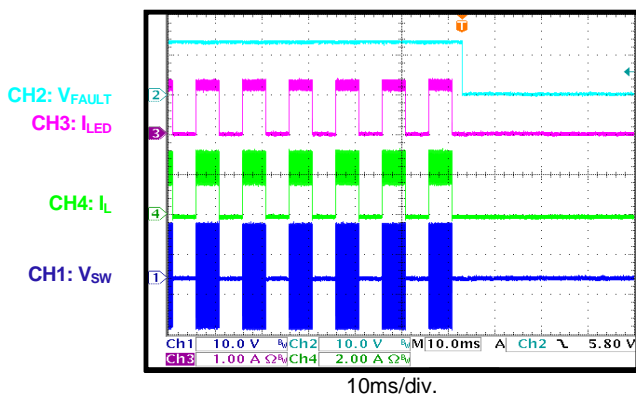

ISET Open after VIN Start-Up

PWM dimming

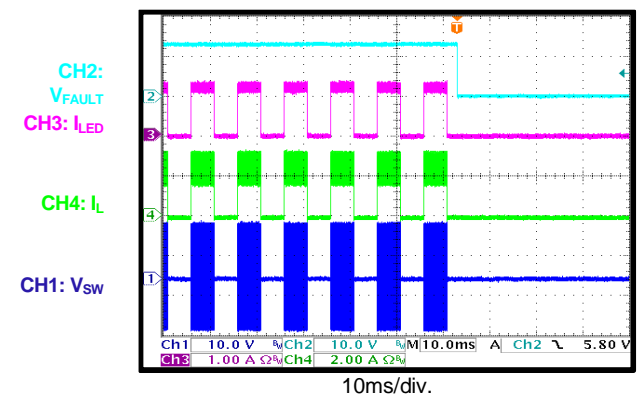

TYPICAL PERFORMANCE CHARACTERISTICS *(continued)*

Buck-boost mode, 4 LEDs ($V_{LED} = 12V$), $V_{IN} = 13.5V$, $I_{LED} = 1.2A$, $f_{SW} = 410kHz$, $L = 10\mu H$, $T_A = 25^\circ C$, unless otherwise noted.

DUTY Short before VIN Start-Up

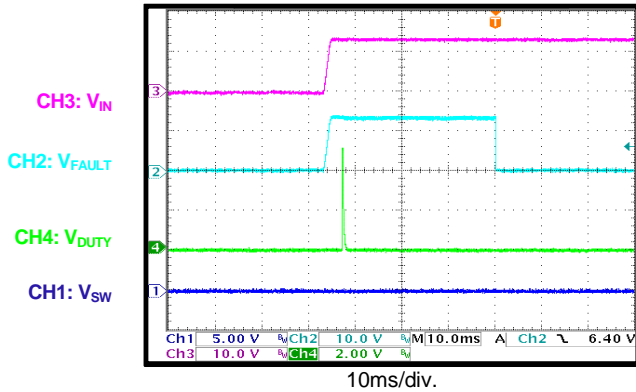

DUTY Open before VIN Start-Up

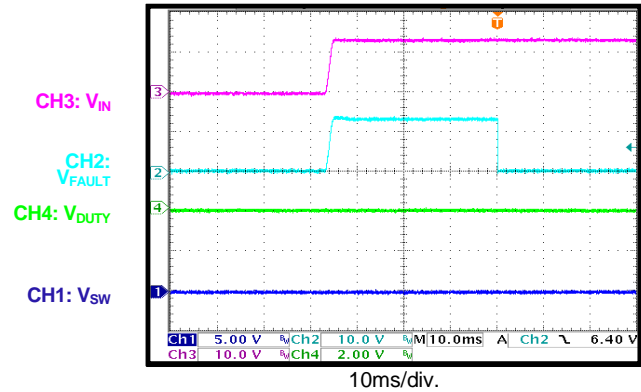

FAULT Short during VIN Start-Up

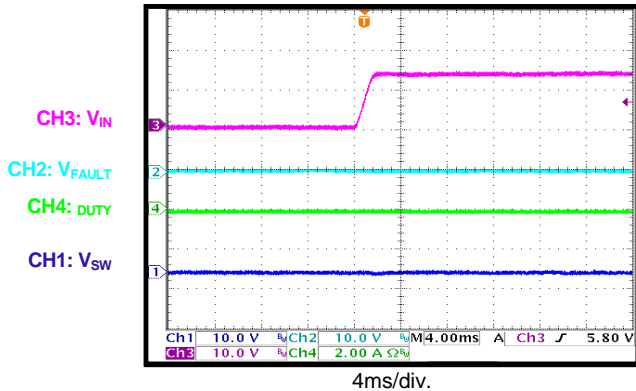

FAULT Short after VIN Start-Up

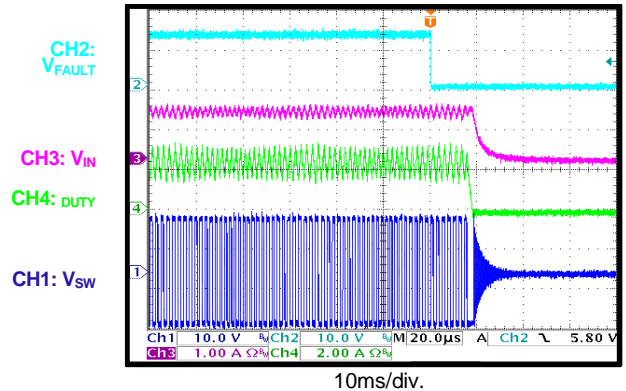

False Mode Detection during VIN Start-Up

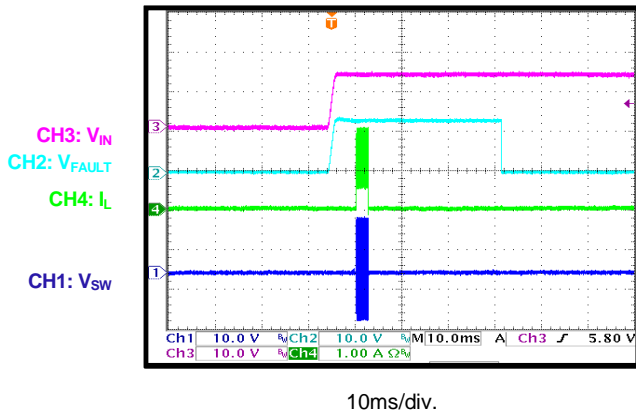

FUNCTIONAL BLOCK DIAGRAM

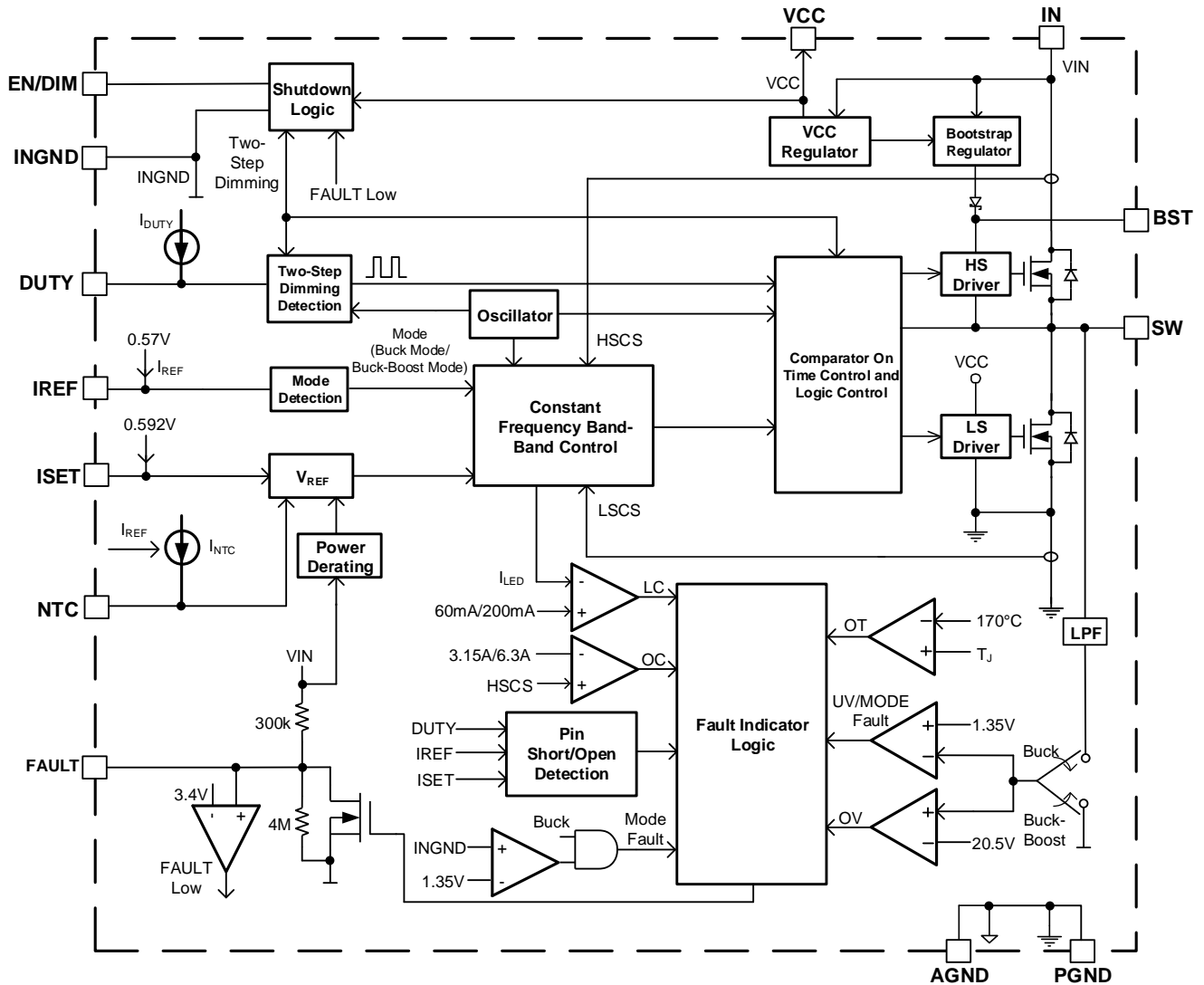

Figure 3: Functional Block Diagram

OPERATION

The MPQ7200A is a fixed-frequency, synchronous, rectified, buck or buck-boost, switch-mode LED driver with built-in power MOSFETs. The device offers a very compact solution to achieve 1.2A of continuous output current in a buck-boost topology and 3A in a buck topology. It also provides excellent load and line regulation across the 6V to 42V input supply range.

Fixed Frequency Band-Band Control

The MPQ7200A uses fixed frequency band-band control with a spread spectrum technique to reduce EMC noise. When compared to fixed-frequency PWM control, band-band control offers the advantages of simpler control loop and faster transient response. Even without an output capacitor, the loop is stable. Band-band control compares the inductor current to two internal thresholds: $I_{BANDPEAK}$ and $I_{BANDVALLEY}$.

When the inductor current exceeds $I_{BANDPEAK}$, the high-side MOSFET (HS-FET) turns off. When the inductor current drops below $I_{BANDVALLEY}$, the HS-FET turns on. $(I_{BANDPEAK} + I_{BANDVALLEY}) / 2$ is controlled by a PID loop to regulate the LED current (I_{LED}). $I_{BANDPEAK} - I_{BANDVALLEY}$ is controlled by a PLL loop to regulate the switching frequency to be about 410kHz. If the minimum on time (t_{ON_MIN}) or minimum off time (t_{OFF_MIN}) is triggered, the switching frequency drops, and the switching frequency can be calculated with (D / t_{ON_MIN}) or $[(1 - D) / t_{OFF_MIN}]$. Where D is the required duty cycle, and t_{ON_MIN} and t_{OFF_MIN} are both 80ns maximum.

The additional spread spectrum uses a 15kHz modulation frequency with a triangular profile to spread the internal oscillator frequency across a $\pm 10\%$ nominal switching frequency window.

Middle Point Inductor Current Sense

The MPQ7200A senses I_{LED} by sensing the middle point of the inductor current (I_{LMID}). I_{LMID} is sensed through the HS-FET or low-side MOSFET (LS-FET) depending on the duty cycle. I_{LMID} is sensed through the HS-FET when the duty exceeds D_{TH_H} (55% in buck mode or 60% in buck-boost mode), or it is sensed through LS-FET when the duty cycle is below D_{TH_L} (45% in buck mode or 40% in buck-boost mode). A duty

cycle hysteresis (D_{TH_HYS} , 10% in buck mode or 20% in buck-boost mode) prevents the current sense from switching between HS-FET and LS-FET at critical duty cycles (see Figure 4).

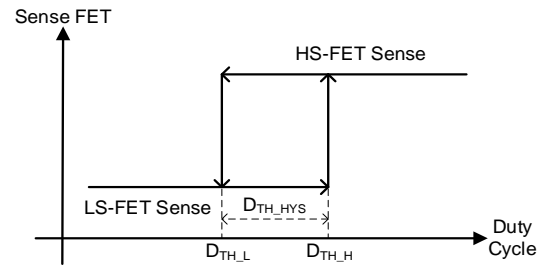

Figure 4: Current-Sense MOSFET vs. Duty Cycle

I_{LED} is equal to I_{LMID} in buck topologies. The LED current is equal to $I_{LMID} \times V_{IN} / (V_{IN} + V_{OUT})$ in buck-boost topologies.

Selecting Buck Mode or Buck-Boost Mode

The MPQ7200A can be configured to a buck or buck-boost topology by connecting a different resistor (R_{IREF}) at the IREF pin. I_{LMID} is sensed through the sensing FET. I_{LED} is equal to I_{LMID} in buck topologies, while it is equal to $I_{LMID} \times V_{IN} / (V_{IN} + V_{OUT})$ in buck-boost topologies.

Mode detection starts when V_{CC} reaches its under-voltage lockout (UVLO) threshold (about 4.7V). A 240 μ A current source (I_{IREF_DET}) flows from the IREF pin to detect the resistor's voltage value during start-up. If the voltage generated by $I_{IREF_DET} \times R_{IREF} < 2.6V$, buck-boost mode is selected. Buck mode is selected when $I_{IREF_DET} \times R_{IREF} > 2.8V$. This means that the corresponding R_{IREF} for buck-boost mode is $\leq 9.09k\Omega$, or $\geq 14.7k\Omega$ for buck mode. To avoid an IREF short fault in buck-boost mode, set the resistor between 1.05k Ω and 9.09k Ω . To avoid an IREF open fault in buck mode, set the resistor between 14.7k Ω and 80.6k Ω .

Once detection finishes, the mode is latched, and $I_{IREF} (0.57V / R_{IREF})$ becomes the reference for the NTC pin current. The latched mode signal is reset by V_{CC} UVLO, but it cannot be reset by pulling EN/DIM low. An internal 1MHz filter works with the 250 μ s deglitch time to protect the part from false mode detection, which can be caused by noise coupling at the pin. To ensure that the detected mode is consistent with the real topology connected, the $V_{INGND} - V_{PGND}$ voltage is

monitored. If the mode is detected as buck mode while $V_{INGND} - V_{PGND}$ exceeds 1.35V, the part latches off and FAULT asserts low. If the mode is detected as buck-boost mode while $V_{INGND} - V_{PGND}$ is below 1.35V (detected as an output under-voltage (UV) condition), the part latches off and FAULT asserts low.

Internal Regulator

The 5.1V internal regulator (VCC) powers most of the internal circuitries. VCC rises after V_{IN} reaches its rising UVLO threshold, regardless of whether EN is high or low. VCC is a reference to PGND/AGND, but not INGND. This means that INGND is not the reference ground for VCC in buck-boost mode.

A lower-value VCC capacitor can cause VCC voltage ringing and lead to unstable switching. It is recommended to place a $\geq 3\mu\text{F}$ decoupling ceramic capacitor at the VCC pin. When choosing the capacitor, consider the capacitance derating to ensure that the capacitance exceeds or is equal to $3\mu\text{F}$. A $10\mu\text{F}$ capacitor with X7R dielectrics and a $\geq 10\text{V}$ DC voltage rating is recommended. V_{CC} has its own UVLO threshold, with a 4.7V rising threshold and a 4.05V falling threshold. Besides powering internal circuitries, VCC can also power external circuitries in the system with a current capability of 25mA.

Continuous Conduction Mode (CCM) and Discontinuous Conduction Mode (DCM)

The MPQ7200A uses continuous conduction mode (CCM) to ensure that the part works with a fixed frequency from the minimum load to full-load range. The advantages of CCM are its controllable frequency and lower output ripple under light loads. When $I_{BANDVALLEY} = 0\text{A}$, the MPQ7200A enters discontinuous conduction mode (DCM). In DCM, the LS-FET acts as an ideal diode. Ensure that the part does not enter DCM, even during start-up or power derating, by selecting an appropriate inductor. Otherwise, LED current precision cannot be guaranteed.

Enable Control (EN)

When the two-step dimming function is not active, EN/DIM is a control pin that turns the LED driver on and off. Drive $V_{EN/DIM} - V_{INGND}$ above 1.67V to turn on the regulator; drive it below 1.58V for 600mA. The MOSFET is fully on in buck-boost mode, and the current limit stays at 6.3A.

longer than 25ms to turn off the device and reset FAULT.

When two-step dimming is activated, the MPQ7200A turns on when V_{IN} and V_{CC} exceed their UVLO thresholds, and EN/DIM is configured to be the two-step dimming control pin. Drive EN/DIM high to select a 100% dimming duty, or drive it low to select a configurable dimming duty set by the DUTY pin. The EN/DIM pin cannot reset FAULT in two-step dimming mode.

Connect EN/DIM to V_{IN} through a resistor in both buck and buck-boost mode. If the enable function is not required in buck mode, connect EN/DIM to VCC. EN/DIM can be floated to shut down the chip due to the internal $1\text{M}\Omega$ resistor connected from EN/DIM to INGND. An integrated Zener diode is placed in parallel with the EN/DIM pin to clamp its voltage to about 7V. This internal Zener diode can handle a 1mA current for load dump voltages up to 100V when a $100\text{k}\Omega$ resistor is connected between the car battery (V_{BATT}) and EN/DIM.

ISET

The LED average current can be configured by a resistor (R_{ISET}) connected at the ISET pin. The LED current (I_{LED}) can be calculated with Equation (1):

$$I_{LED} \text{ (A)} = 16 / R_{ISET} \text{ (k}\Omega) \quad (1)$$

The nominal voltage (V_{ISET}) of the ISET pin is about 0.592V. V_{ISET} can be adjusted below 0.592V to decrease the LED current in power derating or thermal derating.

During the mode detection period at start-up in buck mode, the ISET current is monitored to detect if I_{LED} is above or below 600mA. If $I_{ISET} > 22.2\mu\text{A}$ during this period, I_{LED} is detected to be $>600\text{mA}$, and the MOSFETs fully turn on. If I_{LED} is detected to be $<600\text{mA}$, half of the LS-FETs and HS-FETs turn off to improve current-sense accuracy. When the MOSFETs cut off by half, the current limit drops from 6.3A to 3.15A. The signal that indicates if I_{LED} is above or below 600mA is latched once detection finishes. This signal can only be reset by V_{CC} UVLO. After LED current detection, the MOSFET's $R_{DS(ON)}$ does not change, even if I_{LED} rises above or falls below

During normal operation, the ISET pin is continuously monitored to detect open or short to

GND conditions. If the ISET current rises above this threshold, the device detects a short to ground condition.

If I_{LED} is set below 600mA, the ISET current threshold for short detection is $120\mu A$ (corresponding to a $4.9k\Omega$ resistor or $3.24A I_{LED}$). If the LED current is set above 600mA, the threshold is $220\mu A$ (corresponding to a $2.7k\Omega$ resistor or $5.9A I_{LED}$).

When the ISET current is below $1.4\mu A$ (corresponding to $428k\Omega$ resistor or $37.3mA I_{LED}$), a pin open fault is detected.

The part latches off once the ISET pin detects a short or open fault, regardless of whether FAULT asserts or not. FAULT asserts low immediately if an ISET short or open condition is detected after start-up. There is a 20ms to 45ms delay for FAULT assertion if a short or open condition is detected during start-up.

IREF

The IREF pin configures the device for buck mode or buck-boost mode, then it sets the current in the external NTC. After mode detection finishes, the voltage (V_{IREF}) on the IREF pin is set to $0.57V$ with a 10.5% tolerance. Connect a resistor between IREF and GND to obtain a current (I_{IREF}) equal to $0.57V / R_{IREF}$. This current is used as a reference current for the NTC's current source. Note that the NTC current is $50 \times I_{IREF}$ in buck mode and $5 \times I_{IREF}$ in buck-boost mode.

The IREF pin is continuously monitored to detect open and short to GND conditions. If the IREF current exceeds $90\mu A$ in buck mode (corresponding to a $6.3k\Omega$ resistor) or $900\mu A$ in buck-boost mode (corresponding to a $0.63k\Omega$ resistor), the pin detects a short to GND condition. If the IREF current is below $3\mu A$ in buck mode (corresponding to a $190k\Omega$ resistor) or $40\mu A$ in buck-boost mode (corresponding to a $14.3k\Omega$ resistor), the pin detects an open fault.

The part latches off once the IREF pin detects a short or open condition, regardless of whether FAULT asserts. FAULT asserts low immediately if a short or open fault occurs after start-up. There is a 30ms to 40ms delay for FAULT

Once two-step dimming is activated, the EN/DIM pin is used as the input pin to select whether the dimming is high or low. When the EN/DIM pin is

assertion if a short or open condition is detected during start-up.

PWM Dimming

When two-step dimming is deactivated ($R_{DUTY} = 4.87k\Omega$), an external 100Hz to 2kHz PWM waveform can be applied to the EN/DIM pin. In external PWM dimming mode, the MPQ7200A stops switching when EN/DIM is below $1.58V$ and I_{LED} is $0A$. The device resumes normal operation with a nominal LED current when EN/DIM exceeds $1.67V$. The average LED current is proportional to the PWM duty, and its accuracy can be up to $\pm 15\%$ when $V_{IN} = 13.5V \pm 0.5V$, and T_J is between $25^\circ C$ and $100^\circ C$.

Note that EN/DIM should be high for longer than $100\mu s$. Otherwise, the part may stop switching and latch due to an LED open condition. To avoid this, the EN/DIM voltage should not be low for longer than 10ms (EN/DIM turn-off delay).

Two-Step Dimming

When V_{CC} reaches its UVLO rising threshold ($4.7V$), two-step dimming detection is activated on the DUTY pin. A $45\mu A$ current source (I_{DUTY1}) with a $\pm 11\%$ tolerance flows through the resistor between the DUTY pin and GND.

If the generated voltage (V_{DUTY}) exceeds $3.347V$, an open fault is detected, the part latches off, and FAULT asserts. If $0.302V < V_{DUTY} < 3.347V$, the two-step dimming function is activated, and the two-step dimming duty cycle is selected using Table 1 on page 45. If V_{DUTY} is below $0.302V$, the DUTY current source rises to $600\mu A$ (I_{DUTY2}) with a $\pm 8.75\%$ tolerance to detect V_{DUTY} again.

If $V_{DUTY} > 2.235V$ at this point, two-step dimming is disabled. Then the MPQ7200A can be turned on/off through EN/DIM, or it can work in normal PWM dimming by applying a dimming signal at EN/DIM. If $V_{DUTY} < 0.302V$, a short fault is detected, the part latches off, and FAULT asserts. If $0.302V < V_{DUTY} < 2.235V$, two-step dimming is reactivated and the two-step dimming duty cycle is determined by V_{DUTY} . After this detection, the duty is not affected by changing V_{DUTY} , even if the DUTY pin is opened or shorted to GND.

high, the device operates at a 100% dimming duty cycle; when EN/DIM pin is low, the duty cycle is determined by I_{DUTY} and V_{DUTY} . The

device can switch between dimming values in less than 20ms.

Configurable dimming is implemented as PWM dimming, but not analog dimming. When two-step dimming is activated at I_{DUTY1} , the dimming duty can be set between 15% and 10% with a 1% step. The corresponding typical V_{DUTY} is between 3.347V and 0.302V, with a 33% decrement for

each step. When two-step dimming is activated at I_{DUTY2} , the dimming duty can be set between 9% and 5% with a 1% step. The corresponding V_{DUTY} is between 2.235V and 0.302V, with a 33% decrement for each step.

Table 1 shows the relationship between the two-step dimming duty and V_{DUTY} window when considering different V_{DUTY} threshold tolerances.

Table 1: Two-Step Dimming Duty vs. V_{DUTY} Window

Two-Step Dimming Duty		Corresponding V_{DUTY} Window					
		V_{DUTY_H}			V_{DUTY_L}		
I_{DUTY1}	I_{DUTY2}	Min	Typ	Max	Min	Typ	Max
Latch	No two-step dimming	4.018	4.100	4.182	3.280	3.347	3.414
15%		3.280	3.347	3.414	2.190	2.235	2.279
14%	9%	2.190	2.235	2.279	1.460	1.489	1.519
13%	8%	1.460	1.489	1.519	0.969	0.989	1.009
12%	7%	0.969	0.989	1.009	0.634	0.653	0.673
11%	6%	0.634	0.653	0.673	0.407	0.428	0.449
10%	5%	0.407	0.428	0.449	0.28	0.302	0.34
To I_{DUTY2}	Latch	0.28	0.302	0.34	-		

To prevent errors while selecting the two-step dimming duty, ensure that the V_{DUTY} window is between the minimum V_{DUTY_H} and maximum V_{DUTY_L} values when selecting R_{DUTY} . An E96 series resistor is recommend to select precise dimming values. Table 2 shows the proposed R_{DUTY} in E96 series for different two-step dimming duties, while considering the I_{DUTY} tolerance and a $\pm 3\%$ resistor tolerance

If V_{CC} drops below 4.05V before two-step dimming detection finishes, two-step dimming detection stops and does not restart until V_{CC} rises to 4.7V. The two-step dimming signal, together with the two-step dimming duty, is latched once detection finishes. It only can be reset by V_{CC} UVLO, and not an EN shutdown.

Typically, the two-step dimming frequency is 500Hz ± 50 Hz.

Table 2: Two-Step Dimming Duty vs. R_{DUTY}

2-Step Dimming Duty	R_{DUTY} (Ω)
15%	61900
14%	41200
13%	27400
12%	18200
11%	12100
10%	7870
Two-step dimming deactivated	4870
9%	3090
8%	2050
7%	1370
6%	887
5%	576

Under-Voltage Lockout (UVLO)

Under-voltage lockout (UVLO) protects the chip from operating at an insufficient supply voltage. Both ($V_{IN} - V_{INGND}$) and V_{CC} have UVLO thresholds. $V_{IN} - V_{INGND}$ UVLO has a 6V rising threshold with a 1.1V hysteresis. V_{CC} UVLO has a 4.7V rising threshold with a 0.65V hysteresis. V_{IN} and V_{CC} UVLO do not trigger FAULT.

Fault Detection and Indicator

The MPQ7200A has fault indication. The FAULT pin is the open drain of a MOSFET. FAULT is pulled to VIN through a 300kΩ resistor, and it is pulled to INGND with a 4MΩ pull-down resistor. FAULT is pulled high during normal operation. FAULT pulls low if one of the following occurs: LED short, LED open, thermal shutdown, false mode detection, and over-current protection (OCP). FAULT also asserts if the ISET or IREF pins experience a short or open fault during start-up. If the DUTY pin has a short or open condition, FAULT only asserts if this fault is detected before start-up.

The MPQ7200A senses the output by monitoring the average SW voltage in buck mode, or the INGND voltage in buck-boost mode. If LED+ shorts to LED- or PGND, VOUT drops below its under-voltage (UV) threshold, a short-circuit is detected, and FAULT asserts. If LED+ shorts to the battery, or an LED open or output over-voltage (OV) fault is detected in buck-boost mode, or a low HS-FET current is detected in buck mode, then FAULT asserts. The low-current threshold is 60mA when ILED is set below 600mA, or 120mA when ILED is set above 600mA.

To prevent the part from latching due to cold crank conditions while in buck mode, low-current detection is disabled when VIN drops below 7.5V. If LED+ (INGND) shorts to the battery, VIN - VINGND falls below its UV threshold in buck-boost mode, and FAULT cannot assert. If LED- (PGND) shorts to INGND, VINGND drops below its UV threshold and FAULT asserts. If an LED open fault occurs, VINGND exceeds its OV threshold and FAULT asserts.

At high temperatures, the MPQ7200A operates normally with a reduced current. The device only stops when the internal temperature reaches the 170°C over-temperature protection (OTP) threshold, and FAULT is asserted.

If any fault occurs, the part stops switching, the FAULT output asserts in 20μs, and then the part latches. While latched, VCC is still present, and the part's consumption current is <2mA. FAULT can be reset by VCC UVLO. EN shutdown (EN going low longer than 25ms) can also reset FAULT if two-step dimming is not selected.

At start-up, the FAULT pin is not activated, and remains inactive for at least 30ms. FAULT is active within 40ms to avoid a false fault when multiple FAULT pins are connected and share the same EN signal. However, individual parts are protected and latch off as soon as a fault is detected, regardless of whether FAULT asserts. In PWM dimming mode, the FAULT counter works when the dimming signal is high, which means that fault detection is inactive for 30ms when in PWM dimming mode.

The FAULT pin voltage is monitored by an internal comparator. When the voltage is below 3.2V, the part latches off. When multiple FAULT pins are connected, this turns off all devices on the same light system if a fault occurs

The FAULT pin can withstand a 30mA current and protect itself if the pin shorts to a high voltage (e.g. VBATT). If FAULT is low (<1.6V), the FAULT sink current increases to enhance the pull-down capability. Figure 5 shows the detailed FAULT sink current when the FAULT pin is pulled low at different voltages.

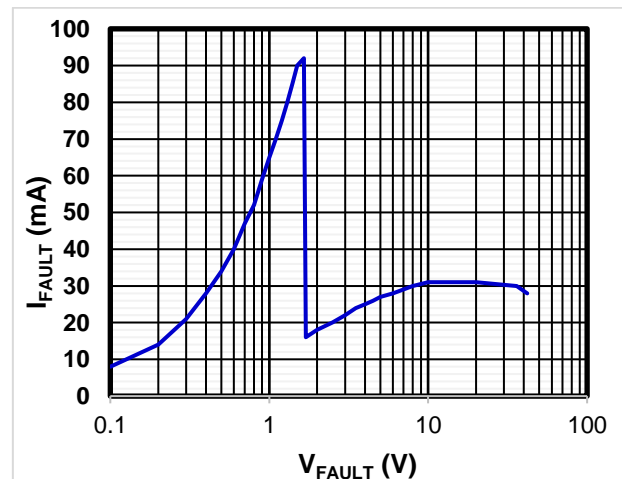

Figure 5: FAULT sink current vs. FAULT voltage

In PWM dimming and two-step dimming, fault conditions may not be detected when the dimming on time is below 100μs. Ensure that the dimming on time exceeds 100μs for normal fault detection operation. Table 3 on page 47 shows the fault detection options.

Table 3: Fault Detection ⁽¹²⁾

Fault Conditions	Detection	
	Buck Mode	Buck-Boost Mode
LED+ short to LED-	V_{OUT} UV ($V_{OUT} < 1.1V$)	INGND UV ($V_{INGND} - V_{PGND} < 1.35V$) ⁽¹³⁾
LED+ short to PGND	V_{OUT} UV ($V_{OUT} < 1.1V$)	INGND UV ($V_{INGND} - V_{PGND} < 1.35V$)
LED+ short to INGND	V_{OUT} UV ($V_{OUT} < 1.1V$)	Normal conditions
LED+ short to battery	Low LED current ($I_{HS} < 60mA$ when $I_{LED_SETTING} < 600mA$; $I_{HS} < 120mA$ when $I_{LED_SETTING} > 600mA$)	Cannot assert FAULT due to $V_{IN} - V_{INGND}$ UVLO
LED- short to INGND	Normal conditions	INGND UV ($V_{INGND} - V_{PGND} < 1.35V$)
LED- short to battery	Cannot assert FAULT due to $V_{IN} - V_{INGND}$ UVLO	Cannot assert FAULT due to $V_{IN} - V_{INGND}$ UVLO
LED open	Low LED current ($I_{HS} < 60mA$ when $I_{LED_SETTING} < 600mA$; $I_{HS} < 120mA$ when $I_{LED_SETTING} > 600mA$)	INGND OV ($V_{INGND} - V_{PGND} > 20.5V$)
Incorrect mode detection	$V_{INGND} - V_{PGND} > 1.35V$	INGND UV ($V_{INGND} - V_{PGND} < 1.35V$)
OTP	$T_J > 170^{\circ}C$	
ISET short ⁽¹⁴⁾	$I_{SET} > 120\mu A$ when $I_{LED_SETTING} < 600mA$; $I_{SET} > 220\mu A$ when $I_{LED_SETTING} > 600mA$	$I_{SET} > 110\mu A$
ISET open ⁽¹⁴⁾	$I_{SET} < 1.4\mu A$	
IREF short ⁽¹⁴⁾	$I_{REF} > 90\mu A$	$I_{REF} > 900\mu A$
IREF open ⁽¹⁴⁾	$I_{REF} < 3\mu A$	$I_{REF} < 40\mu A$
DUTY open ⁽¹⁵⁾	$V_{DUTY1} > 3.355V$	
DUTY short ⁽¹⁵⁾	$V_{DUTY2} < 0.302V$	
OCP	Current limit triggered 3 times continuously	

Notes:

- 12) Once a fault is detected, the part latches and FAULT asserts, unless otherwise noted.
 13) The FAULT pin may not operate normally if $V_{INGND} - V_{PGND}$ is pulled below $-0.3V$ when LED+ shorts to LED- with a long cable.
 14) The part latches if the ISET/IREF pins experience a short or open condition before or after start-up when FAULT is pulled low.
 15) The part latches when the DUTY pin experiences a short or open condition before start-up, and FAULT asserts. After start-up, these conditions cannot be detected.

Over-Current Protection (OCP)

The MPQ7200A has cycle-by-cycle peak current limit protection. The inductor current (I_L) is monitored while the HS-FET is on. If I_L exceeds the current limit value (6.3A when I_{LED} is set above 600mA, or 3.15A when I_{LED} is set below 600mA), the HS-FET turns off immediately. Then the LS-FET turns on to discharge the energy, and I_L decreases. The HS-FET remains off until I_L drops to 0A, at which point another HS-FET on cycle starts. If the over-current (OC) condition still remains after three consecutive retries, the part latches off, reports a failure, and the FAULT pin is asserted.

Load Dump Protection

The MPQ7200A's internal MOSFETs have a 50V absolute maximum rating and a maximum 42V operating voltage. In buck topologies, the maximum voltage can handle load dump conditions up to 42V. In buck-boost topologies, the voltage difference between V_{IN} and PGND is the sum of the car battery's voltage plus the LED voltage. Under load dump conditions, the MPQ7200A can exceed its maximum value

To protect the part from load dump conditions in buck-boost mode, the device stops switching if $V_{IN} - V_{PGND}$ rises above 40V. Then a 100mA sink current at INGND is activated to discharge the output voltage, so the MOSFET only has to handle the V_{IN} stress. The MPQ7200A automatically restarts when $V_{IN} - V_{PGND}$ drops to 39V.

In buck mode, load dump protection is not active and does not trigger FAULT. In buck-boost mode, load dump protection can reset FAULT when FAULT is triggered by other fault conditions, but it cannot reset the device once it has latched.

Power Derating

If V_{IN} falls below a specific voltage (typically 7V) in buck-boost mode, power derating starts. I_{LED} drops linearly with V_{IN} due to analog dimming. Derating continues until V_{IN} reaches the UVLO threshold, then I_{LED} drops by 29%. Power derating is enabled during start-up in buck-boost mode, but it is disabled during start-up in buck mode.

NTC Thermal Derating

Connecting an NTC resistor network (R_{NTC}) to the NTC pin reduces the output current via analog dimming when the sensed temperature rises above the configured value. A current source (I_{NTC}), which $50 \times I_{REF}$ in buck mode or $5 \times I_{REF}$ in buck-boost mode, flows out the NTC pin and generates a voltage (V_{NTC}) that is equal to $I_{NTC} \times R_{NTC}$. V_{NTC} is sensed to indicate the real temperature, and determine the dimming ratio.

When V_{NTC} exceeds 1.25V, there is no dimming. To avoid activating the NTC function, pull the NTC pin above 1.25V, or pull it to VCC.

When V_{NTC} is below 1.2V, dimming is activated, and the dimming ratio drops as V_{NTC} decreases. The dimming ratio falls by a 2% step when V_{NTC} drops by 30mV. When V_{NTC} drops from 1.25V to 0.53V, the LED average current drops to 50% of the set value accordingly. The LED current does not drop below 50% of its set value, even if V_{NTC} falls below 0.48V. If V_{NTC} falls below 0.37V, the MPQ7200A initiates thermal shutdown. When V_{NTC} rises to 0.48V, I_{LED} returns to 50% of its set value.

Thermal Shutdown (TSD)

Thermal shutdown prevents the chip from operating at exceedingly high temperatures. If the die temperature exceeds 170°C, the entire chip shuts down and FAULT is asserted. The device restarts only after being turned off and on again, or after EN is reset.

Floating Driver and Bootstrap Charging

An external bootstrap capacitor powers the floating power MOSFET driver. The bootstrap capacitor voltage is charged to about 5V from VCC through a pass transistor while the LS-FET is on.

This floating driver has its own UVLO protection, with a rising threshold of 2.5V and hysteresis of 700mV. If the BST-to-SW voltage drops to 2.2V, the LS-FET turns on to refresh the BST voltage. It is recommended to use a 22nF to 220nF ceramic capacitor for the bootstrap capacitor.

Consider the capacitor's DC voltage and temperature derating to ensure that the real capacitance is between 22nF and 200nF. A maximum 22Ω resistor can be placed in series with the bootstrap capacitor to reduce SW voltage spikes.

APPLICATION INFORMATION

Selecting Buck Mode or Buck-Boost Mode

The device can be configured for buck or buck-boost mode by connecting a different resistor (R_{IREF}) at the IREF pin. Select a $1.05k\Omega \leq R_{IREF} \leq 9.09k\Omega$ resistor for buck-boost mode, and a $14.7k\Omega \leq R_{IREF} \leq 80.6k\Omega$ resistor for buck mode.

Selecting Dimming Mode

The dimming mode can be configured by connecting a different resistor (R_{DUTY}) at the DUTY pin. Select a $4.87k\Omega$ resistor to disable the internal PWM dimming function and enable external PWM dimming. Table 2 on page 45 lists resistors for two-step dimming, if that function is required.

Setting the LED Current

The external resistor connected to the ISET pin sets the LED current. The value of the external resistor can be calculated with Equation (2):

$$R_3 = \frac{16}{I_{LED}} \text{ (k}\Omega\text{)} \quad (2)$$

Table 4 shows the recommended values for R_3 .

Table 4: Resistor Selection for Common I_{LED} Currents

I_{LED} (A)	R_3 (k Ω)
3	5.36
2	8
1.2	13.3
0.75	21.1

If I_{LED} is below 0.7A in buck-boost mode, certain LED setting resistors are recommended (see Table 5).

Table 5: Resistor Selection when $I_{LED} \leq 700\text{mA}$ in Buck-Boost Mode

I_{LED} (A)	R_3 (k Ω)
0.7	22.6
0.65	24.4
0.6	26.3
0.55	28.6
0.5	31.5
0.45	34.9
0.4	39.1

Figure 6 shows the relationship between I_{LED} and R_{ISET} in buck-boost mode.

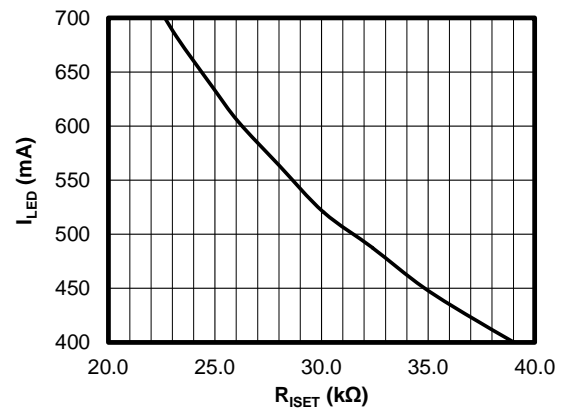

Figure 6: I_{LED} vs. R_{ISET} when $I_{LED} \leq 700\text{mA}$ in Buck-Boost Mode

Selecting the Inductor

For most applications, it is recommended to use an inductor between $4.7\mu\text{H}$ and $33\mu\text{H}$ with a DC current rating that exceeds the maximum inductor current. Include the inductor's DC resistance when estimating the output current and the inductor's power consumption.

For buck mode, the required inductance value can be estimated with Equation (3):

$$L = \frac{V_{OUT} \times (V_{IN} - V_{OUT})}{V_{IN} \times \Delta I_L \times f_{SW}} \quad (3)$$

Choose an inductor ripple current that exceeds 20% of the LED current. The peak inductor current can be calculated with Equation (4):

$$I_{L_PEAK} = I_{L_AVG} + \frac{\Delta I_L}{2} \quad (4)$$

Where I_{L_AVG} is the average current through the inductor. In buck mode, I_{L_AVG} is equal to the output load current (LED current).

Under light-load conditions, use a larger-value inductor to improve efficiency and current precision. Table 6 on page 50 lists the recommended inductor values for common LED currents in buck mode.

Table 6: Buck Mode Inductor Values for Common I_{LED} Currents

I _{LED} (A)	Recommended Inductor Value (μH)
(1A, 3A]	10
(0.5A, 1A)	15
(0.3A, 0.5A]	22
[0.2A, 0.3A)	33

For buck-boost applications, estimate the required inductance value with Equation (5):

$$L = \frac{V_{OUT} \times V_{IN}}{(V_{OUT} + V_{IN}) \times \Delta I_L \times f_{SW}} \quad (5)$$

Where ΔI_L is the inductor's peak-to-peak current ripple. ΔI_L should exceed 25% of the inductor average current when $I_{LED} > 0.7A$. Select ΔI_L to exceed 20% of the inductor average current when $I_{LED} < 0.7A$. I_{L_AVG} can be calculated with Equation (6):

$$I_{L_AVG} = I_{LED} \times \left(1 + \frac{V_{OUT}}{V_{IN}}\right) \quad (6)$$

The peak inductor current can be calculated with Equation (7):

$$I_{L_PEAK} = I_{L_AVG} + \frac{\Delta I_L}{2} \quad (7)$$

Under light-load conditions, use a larger-value inductor to improve efficiency and current precision. Table 7 lists the recommended inductor values for common LED currents in buck-boost mode.

Table 7: Buck-Boost Mode Inductor Values for Common I_{LED} Currents

I _{LED} (A)	Recommended Inductor Value (μH)
(0.75A, 1.2A]	10
(0.5A, 0.75A]	15
(0.3A, 0.5A]	22
[0.2A, 0.3A)	33

Selecting the Input Capacitor

The device has a discontinuous input current in both buck and buck-boost mode, and requires a capacitor to supply AC current to the converter while maintaining the DC input voltage. For the best performance, use low-ESR capacitors. Ceramic capacitors with X5R or X7R dielectrics

are highly recommended because of their low ESR and small temperature coefficients.

For most applications, it is recommended to use a 4.7μF to 22μF capacitor. The input capacitor can be electrolytic, tantalum, or ceramic. When using electrolytic or tantalum capacitors, it is strongly recommended to use an additional, lower-value capacitor (e.g. 0.1μF) with a small package size (0603) to absorb high-frequency switching noise. Place the smaller capacitor as close to VIN and GND (INGND = PGND in buck mode; in buck-boost mode, place the capacitor as close to INGND and PGND as possible).

Since the input capacitor (C_{IN}) absorbs the input switching current in buck mode, the device requires an adequate ripple current rating. The RMS current in the input capacitor can be estimated with Equation (8):

$$I_{CIN} = I_{LOAD} \times \sqrt{\frac{V_{OUT}}{V_{IN}} \times \left(1 - \frac{V_{OUT}}{V_{IN}}\right)} \quad (8)$$

The worst-case condition occurs at $V_{IN} = 2 \times V_{OUT}$, calculated with Equation (9):

$$I_{CIN} = \frac{I_{LOAD}}{2} \quad (9)$$

For simplification, choose an input capacitor with an RMS current rating greater than half of the maximum load current. The input voltage ripple caused by the capacitance can be estimated with Equation (10):

$$\Delta V_{IN} = \frac{I_{LOAD}}{f_{SW} \times C_{IN}} \times \frac{V_{OUT}}{V_{IN}} \times \left(1 - \frac{V_{OUT}}{V_{IN}}\right) \quad (10)$$

If $I_{BANDVALLEY} \geq I_{LED}$ in buck-boost mode, the capacitance can be calculated with Equation (11):

$$\Delta V_{IN} = \frac{I_{LED} \times V_{OUT}}{(V_{IN} + V_{OUT}) \times f_{SW} \times C_{IN}} \quad (11)$$

In buck-boost mode, consider the capacitor between VIN and PGND for VCC regulator stability. Place a 0.44μF to 1μF ceramic capacitor between VIN and PGND to stabilize VCC. Two symmetric (0.1μF + 0.47μF) /50V X7R ceramic capacitors are recommended.

Selecting the Output Capacitor

The output capacitor maintains the DC output voltage. Ceramic, tantalum, or low-ESR

electrolytic capacitors are recommended. For the best results, use low-ESR capacitors to keep the output voltage ripple low.

In buck mode, the output voltage ripple can be estimated with Equation (12):

$$\Delta V_{OUT} = \frac{V_{OUT}}{f_{SW} \times L} \times \left(1 - \frac{V_{OUT}}{V_{IN}}\right) \times \left(R_{ESR} + \frac{1}{8 \times f_{SW} \times C_{OUT}}\right) \quad (12)$$

Where L is the inductor value, and R_{ESR} is the output capacitor's equivalent series resistance (ESR) value.

For ceramic capacitors, the capacitance dominates the impedance at the switching frequency and causes the majority of the output voltage ripple. For simplification, the output voltage ripple can be estimated with Equation (13):

$$\Delta V_{OUT} = \frac{V_{OUT}}{f_{SW} \times L} \times \left(1 - \frac{V_{OUT}}{V_{IN}}\right) \times \left(R_{ESR} + \frac{1}{8 \times f_{SW} \times C_{OUT}}\right) \quad (13)$$

For tantalum or electrolytic capacitors, the ESR dominates the impedance at the switching frequency. For simplification, the output ripple can be estimated with Equation (14):

$$\Delta V_{OUT} = \frac{V_{OUT}}{f_{SW} \times L} \times \left(1 - \frac{V_{OUT}}{V_{IN}}\right) \times R_{ESR} \quad (14)$$

If $I_{BANDVALLEY} \geq I_{LED}$ in buck-boost applications, the output capacitance can be calculated with Equation (15):

$$\Delta V_{OUT} = I_{LED} \times \left(R_{ESR} + \frac{V_{OUT}}{f_{SW} \times C_{OUT} \times (V_{IN} + V_{OUT})}\right) \quad (15)$$

For tantalum or electrolytic capacitors, the ESR dominates the impedance at the switching frequency. For simplification, the output ripple can be estimated with Equation (16):

$$\Delta V_{OUT} = I_{LED} \times R_{ESR} \quad (16)$$

A 4.7µF to 10µF ceramic capacitor is sufficient for most applications.

Selecting the Diode from PGND to INGND in Buck-boost Mode

If the device is operating in buck-boost mode, place a Schottky diode between INGND and PGND to direct the charge current of the capacitor connected between VIN and PGND, especially when the VIN slew rate is high.

The VCC charge current flows from the VCC capacitor to PGND, then back to INGND and the car battery. It is recommended to use a Schottky diode with a low forward voltage (V_F) of about 0.32V, with a 1A current rating and >20V VRRM voltage. A PMEG2010EPAS Schottky diode is recommended.

Selecting the VCC Capacitor

A smaller-value VCC capacitor causes ringing on VCC, and makes the MOSFET unstable. It is recommended to place a $\geq 3\mu F$ decoupling ceramic capacitor at the VCC pin. When selecting a capacitor, consider the capacitance derating to ensure that the real capacitance is at least 3µF. A 10µF X7R with a $\geq 10V$ DC rated voltage capacitor is recommended. VCC is the reference to PGND/AGND.

Selecting a BST Resistor and Capacitor

It is recommended to place a resistor in series with the BST capacitor to reduce the SW spike voltage. A higher resistance reduces SW spikes, but also reduces efficiency. It is recommended to use a 22nF to 220nF ceramic capacitor with a 10/16V DC derating.

Consider efficiency and EMI performance when choosing a resistor. Choose a maximum 22Ω resistor with a 0603/0402 package, as a large package is not required. During normal operation, the average current flowing through R_{BST} is about 20mA in buck mode and 10mA in buck-boost mode. If the capacitor is shorted, the current in the resistor is limited by the internal LDO. The device can quickly detect a failure if the LED current falls below its low limit. Then the part latches off and current is no longer sourced to the resistor. A 0402 package can handle power dissipation on R_{BST} .

PCB Layout Guidelines

Efficient PCB layout, especially input capacitor placement, is critical for stable operation. A 4-layer layout is strongly recommended to improve thermal performance. For the best results, refer to Figure 7 and Figure 8 (on page 53), and follow the guidelines below: ⁽¹⁶⁾ ⁽¹⁷⁾

1. Use a large ground plane to connect directly to PGND.
2. If the bottom layer is a ground plane, add vias near PGND.
3. Ensure that the high-current paths at PGND and VIN have short, direct, and wide traces.
4. Place the ceramic input capacitor, especially the small package (0603) input bypass capacitor, as close to the VIN and PGND pins as possible to minimize high frequency noise. Keep the connection between the input capacitor and VIN as short and wide as possible.
5. Place the VCC capacitor (from the VCC pin and PGND pin) as close to VCC and PGND as possible.
6. Route SW and BST away from sensitive analog areas, such as FB.
7. Place the feedback resistors close to the chip to ensure that the trace connected to the FB pin is as short as possible.
8. Use multiple vias to connect the power planes to internal layers.

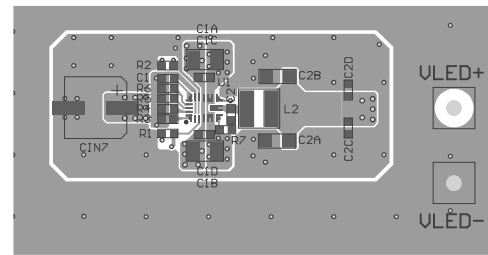

Top Layer

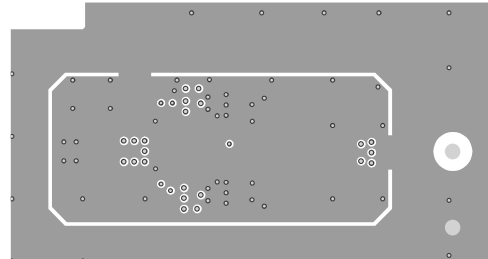

Mid-Layer 1

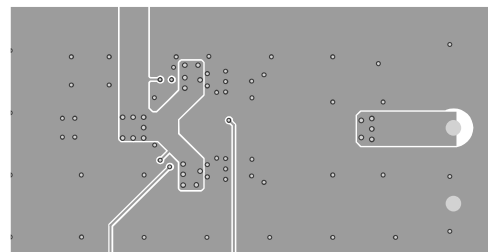

Mid-Layer 2

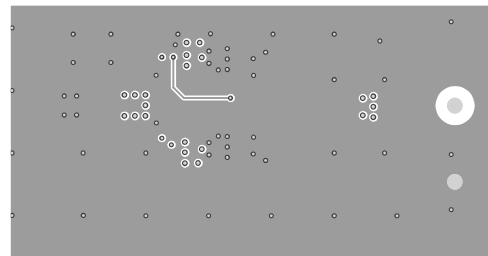

Bottom Layer

Figure 7: Recommended PCB Layout for Buck Mode ⁽¹⁶⁾

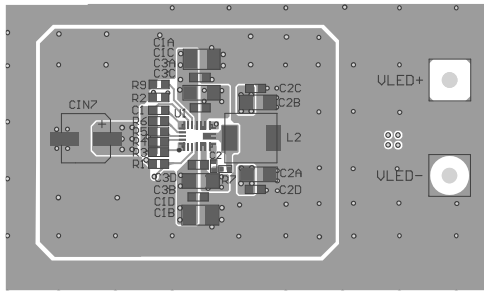

Top Layer

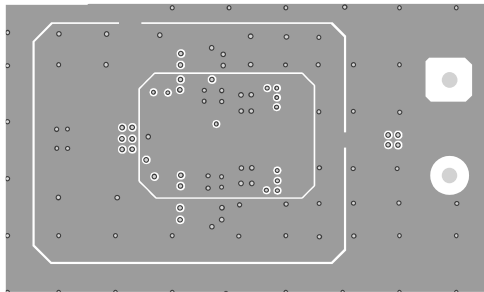

Mid-Layer 1

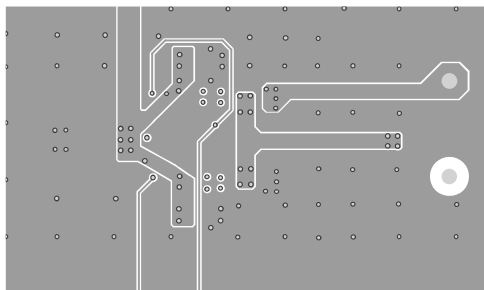

Mid-Layer 2

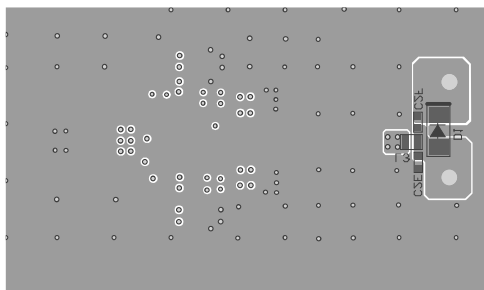

Bottom Layer

Figure 8: Recommended PCB Layout for Buck-Boost Mode ⁽¹⁷⁾

Notes:

- 16) The recommended layout is based on Figure 9 on page 54.
- 17) The recommended layout is based on Figure 10 on page 54.

TYPICAL APPLICATION CIRCUITS

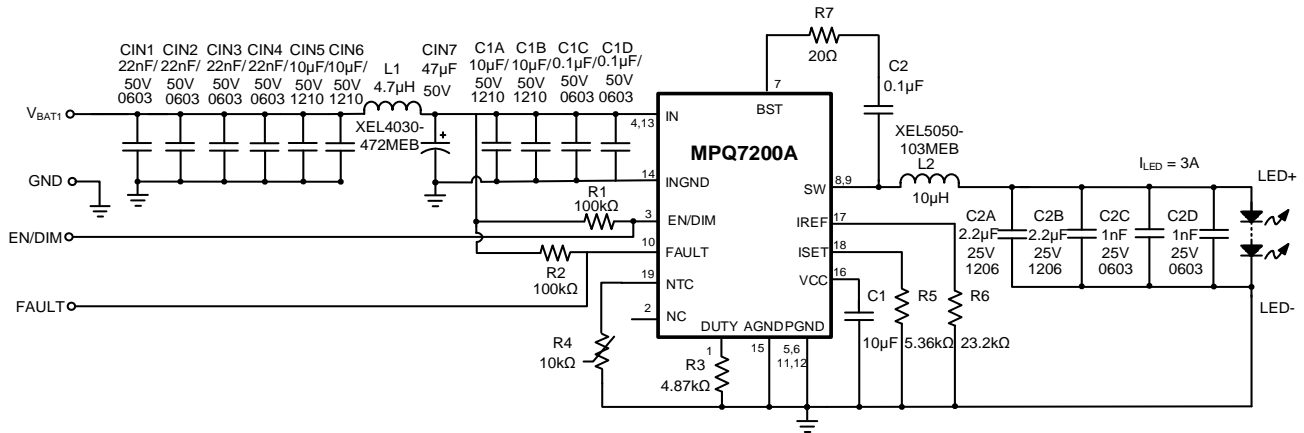

Figure 9: $I_{LED} = 3A$ Buck Application Circuit (No Two-Step Dimming)

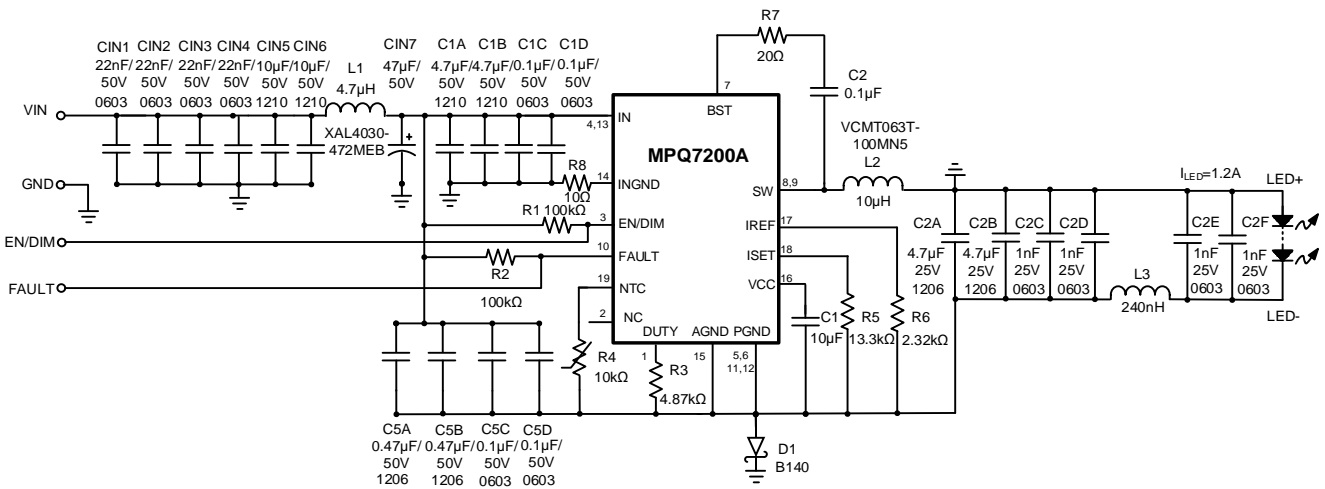

Figure 10: $I_{LED} = 1.2A$ Buck-boost Application Circuit (No Two-Step Dimming)

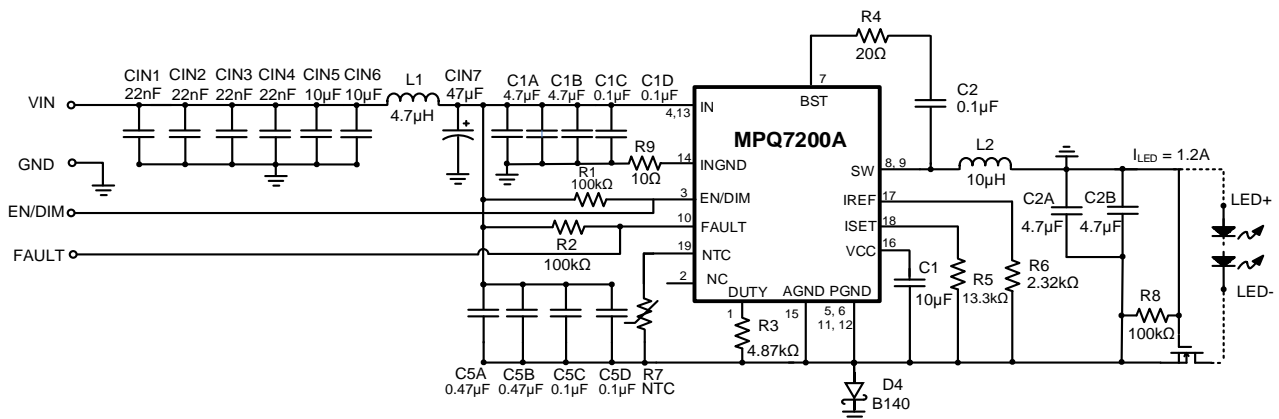
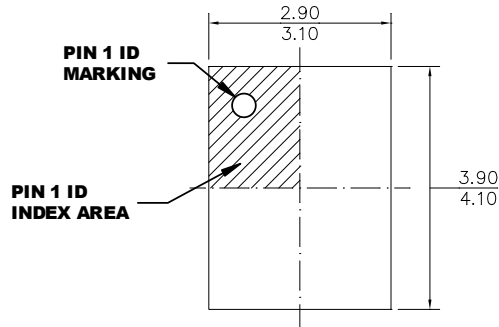

Figure 11: $I_{LED} = 1.2A$ Buck-boost Application Circuit with LED+ Short to Battery Protection

PACKAGE INFORMATION

QFN-19 (3mmx4mm) Wettable Flank



TOP VIEW

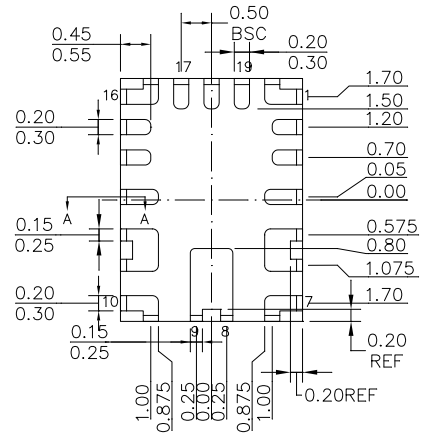

BOTTOM VIEW

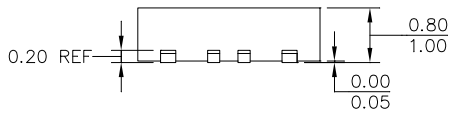

SIDE VIEW

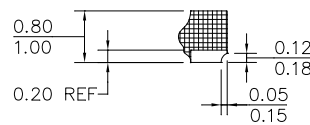

SECTION A-A

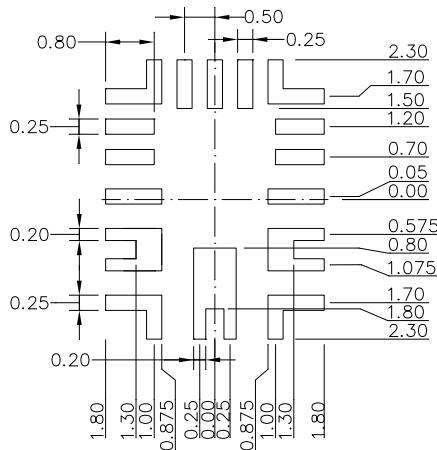

RECOMMENDED LAND PATTERN

NOTE:

- 1) ALL DIMENSIONS ARE IN MILLIMETERS.
- 2) EXPOSED PADDLE SIZE DOES NOT INCLUDE MOLD FLASH.
- 3) LEAD COPLANARITY SHALL BE 0.08 MILLIMETERS MAX.
- 4) JEDEC REFERENCE IS MO-220.
- 5) DRAWING IS NOT TO SCALE.

CARRIER INFORMATION

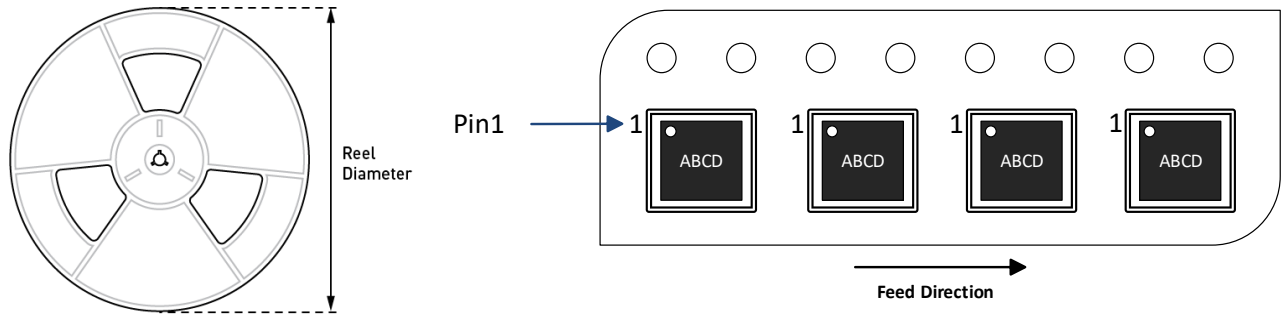

Part Number	Package Description	Quantity/ Reel	Reel Diameter	Carrier Tape Width	Carrier Tape Pitch
MPQ7200AGLE-AEC1-Z	QFN-19 (3mmx4mm)	5000	13in	12mm	8mm

REVISION HISTORY

Revision #	Revision Date	Description	Pages Updated
1.0	11/01/2021	Initial Release	-

Notice: The information in this document is subject to change without notice. Users should warrant and guarantee that third-party Intellectual Property rights are not infringed upon when integrating MPS products into any application. MPS will not assume any legal responsibility for any said applications.