

VOICE/DATA/VIDEO

Testers & Tools



**KLEIN
TOOLS®**

VOICE/DATA/VIDEO TESTERS & TOOLS

VDV

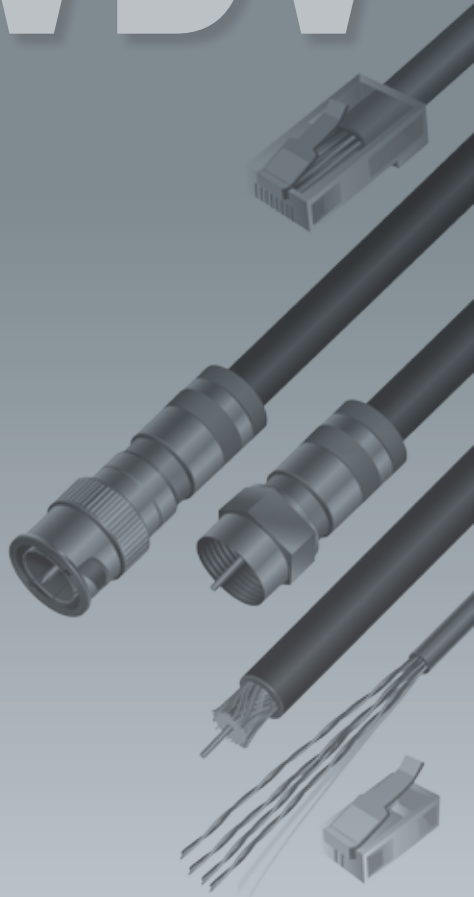

Klein Tools® introduces an extensive line of Voice/Data/Video (VDV) Testers and Tools that meet or exceed the needs of professionals. This new line of VDV Testers and Tools helps prepare, connect and test CATV, home theater, satellite, network, phone and security systems.

- **PREP**pages 4-10
- **CONNECT**pages 11-17
- **TEST**pages 18-22
- **TOOLS**pages 23-34
- **KITS**page 35

KLEIN TOOLS®

1 PREPARATION



CUT STRIP



2 CONNECTION



3 TESTING



CRIMP
TERMINATE

IDENTIFY
VERIFY



Voice/Data/Video Prep



Electrician's Scissors

Stainless Steel Electrician's Scissors – Stripping Notches

- Stainless steel blades to maintain blade durability and sharpness.
- Notched upper blade for stripping 19 AWG & 23 AWG wire.
- Blade is fully serrated for non-slip cutting action.
- Free-fall snip feature for ease of use (2100-8).
- Cuts electrical communication 19 AWG - 23 AWG wire.
- Extended handle provides comfort and cutting leverage for wire cutting application (2100-8).
- 56 HRC.



2100-9



2100-8

Cat. No.	Overall Length	Cutting Length	Weight (lbs.)
2100-7*	5-1/4" (133 mm)	1-7/8" (48 mm)	.20
2100-8	6-5/16" (160 mm)	1-7/8" (48 mm)	.21
2100-9	5-1/4" (133 mm)	1-7/8" (48 mm)	.21
2101-1*	1-7/8" (48 mm)	6-5/16" (160 mm)	.21

* Nickel-plated carbon steel blades.

All dimensions are in inches and (millimeters).

⚠WARNING: Read carefully and understand instructions before using this tool.

⚠WARNING: Always wear approved eye protection.

⚠WARNING: NOT insulated. Will NOT protect against electrical shock.

⚠WARNING: Never use on or near live electrical circuits.

Cable Cutters

Multi-Cable Cutter

- Hardened steel precision-ground cutting blades for long life.
- Copper curved cutter cleanly cuts round copper cable without compression or frayed ends.
- Anvil cutter for solid and stranded copper wire up to 12 AWG and stainless steel up to .032" (.81 mm) diameter.
- Mild steel cutter for conductors up to .080" (2 mm) diameter.
- Curved cutter for solid and stranded copper wire up to 8 AWG, multi-conductor cable up to 1/2" (13 mm) diameter and coaxial cable RG-6 Quad, RG-59, and RG-62.
- Coil spring provides fast self-opening action.
- Handy closure lock for convenient storage.



63020

Cat. No.	Overall Length	Screw Shearing	Handle Color	Weight (lbs.)
63020	7" (177 mm)	6-32 & 8-32	red	.44

Cable Cutters – Coaxial

- Cable-gripping jaws quickly score jacket and insulation, and easily cut through copper inner conductor.
- Blades cleanly cut aluminum and copper coaxial cable without compression and frayed ends.
- Forged body with heat-treated and precision-ground steel blades, withstands frequent cutting.
- Hot-riveted design requires no adjustment while maintaining a smooth, precise operation.
- Handles are plastic-coated for maximum comfort and gripping power.
- When cutting drop wire with an inner steel conductor, we recommend Cat. No. D2000-28 diagonal-cutting pliers.



63028



63030

▲WARNING: Do NOT use to cut steel or ACSR.

Cat. No.	Overall Length	Soft Cable-Cutting Maximum Capacity	Handle Color	Weight (lbs.)
63028	8-1/4" (216 mm)	.75" (19 mm) diameter	yellow	.80
63030	8-1/4" (216 mm)	1" (25 mm) diameter	blue	.83

Compact Cable Cutter

- Precise, one-hand shearing action cuts 24 AWG copper, aluminum multi-strand cable and wire, and 100-pair telephone cable.
- Special shear angle cuts cleanly without compression to cable geometry for telecom cable work.
- Heat-treated, high-carbon steel shearing edges for long life.
- Forged body with 3/8" (10 mm) case-hardened rivet.
- Plastic-dipped handles for comfort.
- Not designed for cutting steel or ACSR.



63055

▲WARNING: Do NOT use to cut steel or ACSR.

Cat. No.	Overall Length	Maximum Cable Cutting Capacity	Handle Color	Weight (lbs.)
63055	8" (203 mm)	24 AWG copper, aluminum multi-strand cable and wire, and 100-pair telephone cable	red	.65

All dimensions are in inches and (millimeters).

▲WARNING: Read carefully and understand instructions before using this tool.

▲WARNING: Always wear approved eye protection.

▲WARNING: NOT insulated. Will NOT protect against electrical shock.

▲WARNING: Never use on or near live electrical circuits.

Voice/Data/Video Tools

Radial Stripper UTP/STP

- One-step outer jacket stripping, 1-level, of category 3, 5, 5e, and 6 cables.
- Durable high-carbon steel cutting blades are ground and honed for long life.
- Removes the outer jacket of twisted pair cable without damaging the conductors.
- Strip and slit lengths may be varied to accommodate different connector requirements.
- Recessed cutting surface slits long runs of twisted-pair cable.
- Multiple nest cavities allow the removal of a wide variety of jacket materials on twisted-pair cable.
- Tension loop can be disengaged for thin-jacket cable.
- One-piece construction ensures alignment for precise stripping.
- Large finger loop promotes rotation during use.
- Adjustable set-screw prevents twisted-pair conductor insulation scoring.
- Bright, highly visible color for easy identification.



VDV120-006

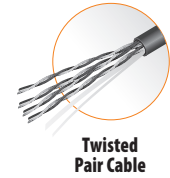

Twisted Pair Cable

UTP STP

Cat. No.	Color	Strips or Slits	Level(s)	Strip/Slit Dimensions	Prepared Cable	Overall Length	Weight (oz.)
VDV120-006	yellow	unshielded twisted pair shielded twisted pair	1	strip length varies by application		4.4" (112 mm)	1.3

Coax Cable Stripper – 2-Level, Radial

- Designed for easy single operation cable preparations.
- Exclusive sliding depth gauge for easy debris clean-out and variable stripping capability.
- Durable high-carbon steel pre-set cutting-blades for precise, accurate cable stripping.
- 2-level coaxial preparation – 5/16" x 1/4" (7.9 mm x 6.4 mm).
- Finger loop promotes rotation during use.
- Bright, highly visible color for easy identification.



VDV110-061



Coax Cable
2 Level

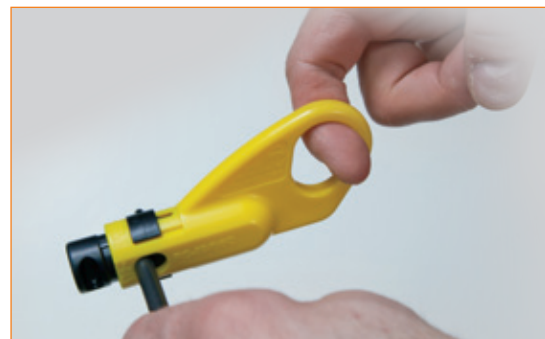

R59 RG6 RG6-QS

Cat. No.	Color	Levels	Strip Dimensions	Blade Configuration	Prepared Cable	Overall Length	Weight (oz)
VDV110-061	yellow/black	2	5/16" x 1/4" (7.9 mm x 6.4 mm)			4.6" (116 mm)	1.2

All dimensions are in inches and (millimeters).

⚠WARNING: Read carefully and understand instructions before using this tool.

⚠WARNING: NOT insulated. Will NOT protect against electrical shock.

⚠WARNING: Always wear approved eye protection.

⚠WARNING: Never use on or near live electrical circuits.

Voice/Data/Video Tools

Dual Cartridge Radial Stripper – 2 & 1 Level

- 2-level coaxial preparation of 5/16" x 1/4" (7.9mm x 6.4mm).
- Strips outer jacket of Unshielded Twisted-Pair (UTP) cables (category 3, 5, 5e and 6), 1-level preparation.
- Designed for high-volume, multiple-type cable preparation environments.
- Two "active" stripping cartridge-bays and third "storage" cartridge-bay.
- One-piece construction ensures precise stripping and never requires adjustment.
- Large finger loop promotes rotation during use.
- Cartridges snap in from both sides for left or right-handed operation.
- F-Connector "nest" assists with cable insertion.
- Durable high-carbon steel cartridge cutting blades are ground and honed for long life.
- Durable Delrin® resin for outstanding wear.
- Replacement cartridges available.

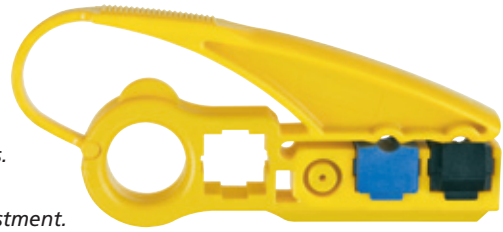

VDV100-801

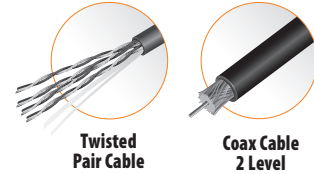

Twisted Pair Cable

Coax Cable 2 Level

Delrin® is a registered trademark of DuPont.

Cat. No.	Set Contains	Overall Length	Weight (oz.)				
VDV100-801		5.6" (143 mm)	2.4				
Cat. No.	Description	Color	Level(s)	Strip Dimensions	Blade Configuration	Prepared Cable	
VDV100-001	dual cartridge radial stripper frame	yellow	-	-	-	-	
RG6	VDV110-003	RG59/RG6/RG6 QS coaxial cable	black	2	5/16" x 1/4" (7.9 mm x 6.4 mm)		
RG59	VDV120-005	UTP cable	blue	1	variable		
RG6 QS							
UTP							

Radial Cartridge Strippers

- 2-level coaxial preparation of 5/16" x 1/4" (7.9 mm x 6.4 mm) (Cat. No. VDV110-802).
- 3-level coaxial preparation of 0.235" x 0.235" (6 mm x 6 mm) and trimming center conductor to desired length (Cat. No. VDV113-804).
- Designed for high-volume, cable preparation environments.
- "Active" stripping cartridge-bay and second "storage" cartridge-bay.
- One-piece construction ensures precise stripping and never requires adjustment.
- Large finger loop promotes rotation during use.
- Cartridges snap in from both sides for left or right-handed operation.
- Durable high-carbon steel cartridge cutting blades are ground and honed for long life.
- Durable Delrin® resin for outstanding wear.
- Replacement cartridges available.

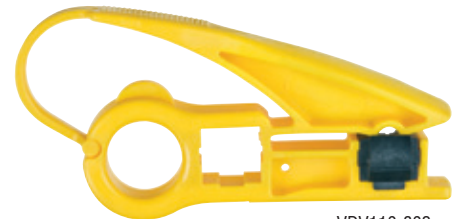

VDV110-802



Coax Cable 3 Level

Coax Cable 2 Level

Delrin® is a registered trademark of DuPont.

Cat. No.	Set Contains	Overall Length	Weight (oz.)				
VDV110-802		5.2" (133 mm)	2.1				
Cat. No.	Description	Color	Level(s)	Strip Dimensions	Blade Configuration	Prepared Cable	
VDV100-002	radial cartridge stripper frame	yellow	-	-	-	-	
RG6	VDV110-003	RG59/RG6/RG6 QS coaxial cable	black	2	5/16" x 1/4" (7.9 mm x 6.4 mm)		
RG6-QS							
RG59							
Cat. No.	Set Contains	Overall Length	Weight (oz.)				
VDV113-804		5.2" (133 mm)	2.1				
Cat. No.	Description	Color	Level(s)	Strip Dimensions	Blade Configuration	Prepared Cable	
VDV100-002	radial cartridge stripper frame	yellow	-	-	-	-	
RG58	VDV113-021	RG58/RG59/RG62 coaxial cable	green	3	0.235" x 0.235" x variable (6 mm x 6 mm x variable)		
RG59							
RG62							

All dimensions are in inches and (millimeters).

- ⚠ **WARNING:** Read carefully and understand instructions before using this tool.
- ⚠ **WARNING:** Always wear approved eye protection.

- ⚠ **WARNING:** NOT insulated. Will NOT protect against electrical shock.
- ⚠ **WARNING:** Never use on or near live electrical circuits.

Voice/Data/Video Tools

Radial Stripper Cartridges

Designed for use with:

- Dual Cartridge Radial Stripper (Cat. No. VDV100-801)
- Dual Cartridge Radial Stripper Frame (Cat. No. VDV100-001)
- Radial Cartridge Stripper (Cat. Nos. VDV110-802 & VDV113-804)
- Radial Cartridge Stripper Frame (Cat. No. VDV100-002)

- Pre-set cutting blades for precise, accurate and efficient cable stripping.
- Durable high-carbon steel cutting blades are ground and honed for long life.
- Patented "V" notch eliminates scoring of the center conductor.*
- Color coded for easy identification.
- Meets industry standards established by the SCTE (Society of Cable Telecommunication Engineers).
- Cartridges made from glass filled polycarbonate for superior strength and extended durability.

*All cartridges except for VDV120-005.



VDV110-003



VDV110-004



Coax Cable
2 Level



VDV110-020



Mini Coax Cable
2 Level



VDV113-022



VDV113-021



Coax Cable
3 Level



VDV120-005



Twisted
Pair Cable
1 Level

Cat No.	Cable	Color	Level	Cartridge Strip Dimensions	Cable Illustration	Cartridge Detail	Weight (oz.)
VDV110-003	RG59/RG6/RG6 QS coaxial cable	black	2	5/16" x 1/4" (7.9 mm x 6.4 mm)			0.1
VDV110-004	RG7/RG11 coaxial cable	gray	2	5/16" x 1/4" (7.9 mm x 6.4 mm)			0.1
VDV120-005	UTP cable (category 3, 5, 5e and 6)	blue	1	variable			0.1
VDV110-020	mini-coaxial cable	green	2	1/4" x 1/4" (6.4 mm x 6.4 mm)			0.1
VDV113-021	RG58/RG59/RG62 coaxial cable	green	3	0.235" x 0.235" x variable (6 mm x 6 mm x variable)			0.1
VDV113-022	RG58/RG59/RG62 coaxial cable	brown	3	0.109" x 0.312" x variable (2.8 mm x 7.9 mm x variable)			0.1

All dimensions are in inches and (millimeters).

⚠WARNING: Read carefully and understand instructions before using this tool.

⚠WARNING: NOT insulated. Will NOT protect against electrical shock.

⚠WARNING: Always wear approved eye protection.

⚠WARNING: Never use on or near live electrical circuits.

Voice/Data/Video Tools

Katapult® Coaxial Cable Stripper KATAPULT®

- Quick and easy RG6 coaxial cable stripping.
- Compound action cable stripping – grip and strip via single action squeezing motion.
- Precision, machined steel cutting blades cleanly and easily strip RG6 coaxial cable.
- Tension loaded wire-grip gently holds the cable in place while retaining the cable geometry.
- Recoil spring design returns tool to ready position upon cycle completion.
- Cast alloy chassis with heavy-duty Ecoat finish for corrosion resistance and durability.
- Yellow grips enhance comfort and visibility, and allow quick identification.
- Katapult® Wire Stripper – 8 – 22 AWG (Cat. No. 11063), wire stop/gauge and replacement blade sets are also available.



RG6

VDV110-045

Cat. No.	Color	Strips	Level(s)	Overall Length	Weight (oz.)
VDV110-045	yellow/black	RG6	1 center conductor, 1 outer jacket	6.6" (168 mm)	12.1
Replacement Blades Sets					
VDV110-046	RG6 coaxial cable replacement blades				.01
11073	8 – 22 AWG wire stripping blades				.01
11074	16 – 26 AWG (1.0 mm ² – .14 mm ²)				.01
Wire Stop/Gauge					
11081	adjustable wire stop				.01



Coax Cable

Telecom Tools

Diagonal Bell-System Pliers – “W” & “V” Notches

- “W” notches to cleanly slit insulation.
- “V” notch at the hinge for quick insulation crushing.
- Tapered nose for easy working in confined areas and close tip cutting.



D528V

Cat. No.	Overall Length	Jaw Length	Jaw Width	Jaw Thickness	Cutting Knives	Handle Finish	Handle Color	Weight (lbs.)
D528V	5-3/16" (132 mm)	13/16" (21 mm)	9/16" (14 mm)	3/8" (10 mm)	standard	plastic-dipped	red	.20

Diagonal Telephone Work Pliers – Type D-6

- Tapered nose for easy working in confined areas and close tip cutting.
- Convenient .030" and .045" stripping holes.
- “V” stripping notch in jaw for quick insulation slitting.
- Serrated behind the hinge to crush insulation.



72192

Cat. No.	Overall Length	Jaw Length	Jaw Width	Jaw Thickness	Cutting Knives	Handle Finish	Handle Color	Weight (lbs.)
72192	6-1/8" (156 mm)	13/16" (21 mm)	3/4" (19 mm)	7/16" (11 mm)	standard	plastic-dipped	red	.33

All dimensions are in inches and (millimeters).

⚠WARNING: Read carefully and understand instructions before using this tool.

⚠WARNING: Always wear approved eye protection.

⚠WARNING: NOT insulated. Will NOT protect against electrical shock.

⚠WARNING: Never use on or near live electrical circuits.

Telecom Tools

Long-Nose Telephone Work Pliers – Stripping

- Cleanly strips 22 (.34 mm²) to 24 (.25 mm²) AWG wire.
- Convenient insulation crushing slot.
- Curved handles provide greater tool control.



D2291

Cat. No.	Overall Length	Jaw Length	Jaw Width	Jaw Thickness	Point Thickness	Handle Finish	Handle Color	Weight (lbs.)
D2291	6" (152 mm)	1-1/4" (32 mm)	11/16" (18 mm)	3/8" (10 mm)	1/16" x 3/32" (1.6 mm x 2 mm)	plastic-dipped	yellow	.25

Long-Nose Telephone Work Pliers – Type L1

- Knurled jaw tips for greater gripping power.
- Induction hardened side-cutting knives for long life.
- Convenient .030" stripping hole.
- Curved handles provide greater tool control.



71980

Cat. No.	Type	Overall Length	Jaw Length	Jaw Width	Jaw Thickness	Knife Length	Point Thickness	Handle Finish	Handle Color	Weight (lbs.)
71980	L1	6-5/8" (168 mm)	1-7/8" (48 mm)	11/16" (18 mm)	3/8" (10 mm)	1/2" (13 mm)	1/16" x 3/32" (1.6 mm x 2 mm)	plastic-dipped	yellow	.25

Standard Long-Nose Pliers – Switchboard Work

- Cleanly strips 19 & 22 AWG wire.
- Induction hardened, long-lasting cutting knives.
- Knurled jaws for sure wrapping and looping.
- Curved handles provide greater tool control.



D203-6H2

Cat. No.	Overall Length	Jaw Length	Jaw Width	Jaw Thickness	Knife Length	Point Thickness	Handle Finish	Handle Color	Weight (lbs.)
D203-6H2	6-5/8" (168 mm)	1-7/8" (48 mm)	11/16" (18 mm)	3/8" (10 mm)	1/2" (13 mm)	3/32" (2 mm)	plastic-dipped	yellow	.26

Industrial Utility Snips

High-Leverage Kevlar® Snip

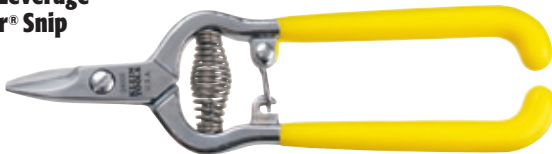

24000

- Nickel chrome plating resists corrosion and rusting.
- One blade is serrated for non-slip cutting action.
- Spring loaded for self opening action.
- Handy closure lock for convenient storage (24000, 24001).
- Compatible for right- and left-handed users.
- Excellent for cutting Kevlar® insulation in fiber optic applications (24000, 24001).
- Excellent for cutting electronics and filaments (24005).

Cat. No.	Overall Length	Cutting Length	Weight (lbs.)
24000	6-1/2" (165 mm)	5/8" (16 mm)	.28
24001	6-1/2" (165 mm)	1" (25 mm)	.28
24005	5" (127 mm)	1" (25 mm)	.22

Kevlar® is a registered trademark of E.I. du Pont de Nemours and Company.

Spring Action Snip



24001

5" Electronic Filament Snip



24005

All dimensions are in inches and (millimeters).

⚠WARNING: Read carefully and understand instructions before using this tool.

⚠WARNING: Always wear approved eye protection.

⚠WARNING: NOT insulated. Will NOT protect against electrical shock.

⚠WARNING: Never use on or near live electrical circuits.

Voice/Data/Video **Connect**



Compression Crimper – Lateral, Multi Connector

- One tool crimps most connectors to most coaxial cables – Minicoax, RG58, RG59, RG62, RG6, RG6QS, RG7, and RG11.
- Unique cable selection wheel eliminates the need to change plunger tips saving time and not losing parts.
- Heavy-duty zinc die-cast chassis for durable, long lasting performance.
- Open design with 180° capture mechanism provides easy insertion, complete compression and simple removal.
- Integrated handle lock for easy storage.
- Spring loaded return increases user comfort and ease of use.
- Yellow and black contoured grips enhance comfort, visibility and allow quick identification.



VDV211-063

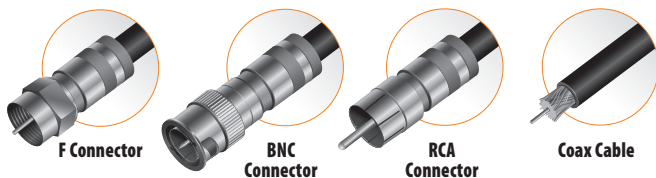

Mini-Coax	R59	RG6	RG6-QS
-----------	-----	-----	--------

Cat. No	Color	Type	Cable	Connectors	Overall Length	Weight (oz.)
VDV211-063	yellow/black	compression crimper	coaxial	BNC F RCA	6.25" (158 mm)	18.5

All dimensions are in inches and (millimeters).

⚠WARNING: Read carefully and understand instructions before using this tool.

⚠WARNING: NOT insulated. Will NOT protect against electrical shock.

⚠WARNING: Always wear approved eye protection.

⚠WARNING: Never use on or near live electrical circuits.

Voice/Data/Video Tools

Compression Crimper – Compact, Multi-Connector

- Fast, reliable multiple-type compression connector installations.
- Crimps compression BNC, F and RCA connectors to coaxial cable.
- Steel body with chrome finish resists corrosion and extends tool life.
- Adjustable universal plunger ensures accurate crimps on multiple types of connectors.
- Open design with 180° capture mechanism provides easy insertion, complete compression and simple removal of cable and connector.
- Compact tool with integrated handle lock for easy storage.
- Enhanced pivot point for smooth wobble free operation.
- Spring loaded return increases user comfort and ease of use.
- Intergrated F-connector "nest" assists with cable insertion.
- Yellow contoured grips enhance comfort, visibility and allow quick identification.



VDV211-048

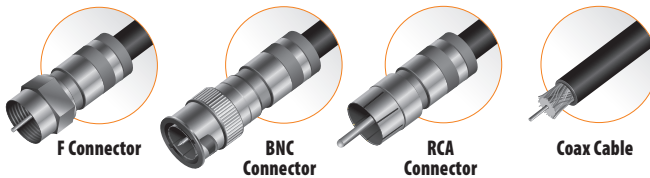

Cat. No	Color	Type	Cable	Connectors	Overall Length	Weight (oz.)
VDV211-048	yellow/chrome	compression crimper	coaxial	BNC F RCA	5.6' (142 mm)	8.0

Compression Crimper – Vertical, Multi-Connector

- Fast reliable tool for CATV, Home Theater, Satellite and Security System applications where multiple-type connector installations are required.
- Crimps compression BNC, F and RCA connectors to minicoax RG59, RG6, and RG6-Quadshield coaxial cables.
- Vertical design for easy adjustment, insertion, crimping and removal of cable and connector.
- Adjustable universal plunger tips and crimp-height with locking-nut ensure accurate crimps on multiple types of connectors.
- Measuring guide beneath the plunger makes replicating the same compression setting efficient.
- Ratchet mechanism is designed to prevent the release of the connector prior to full compression.



VDV211-007

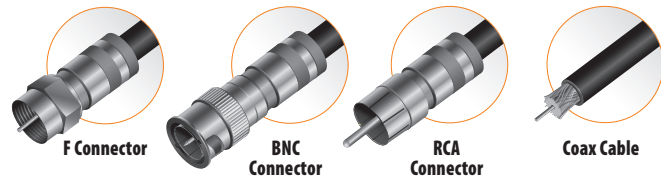

Cat. No.	Color	Type	Cable	Connectors	Overall Length	Weight (oz.)
VDV211-007	yellow/black	compression crimper	coaxial	BNC, F and RCA	7.8 (197 mm)	15.3

All dimensions are in inches and (millimeters).

⚠WARNING: Read carefully and understand instructions before using this tool.

⚠WARNING: NOT insulated. Will NOT protect against electrical shock.

⚠WARNING: Always wear approved eye protection.

⚠WARNING: Never use on or near live electrical circuits.

Voice/Data/Video Tools

Compact, F-Connector

- Fast, reliable F-Connector installation tool.
- Steel body with black-oxide finish for corrosion resistance and durability.
- Fixed plunger allows quick, easy insertion and removal of cable and connector.
- Fixed plunger accepts many common F-connector compression fittings.
- Compact tool with integrated handle lock.
- Yellow and black grips enhance comfort, visibility and allow quick identification.
- Spring loaded return increases user comfort and ease of use.



VDV212-008

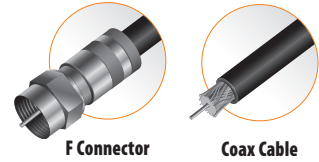

F Connector

Coax Cable

Mini-Coax	R59	RG6	RG6-QS
-----------	-----	-----	--------

Cat. No.	Color	Type	Cable	Connectors	Overall Length	Weight (oz.)
VDV212-008	yellow/black	compression crimper	coaxial	common F connectors	5.6" (142 mm)	9.8

Coaxial Cable All-In-One Tool

- Machined steel cutting blades cleanly and easily cut RG6 and RG59 coaxial cable.
- Diamond-shaped stripping nests efficiently remove outer jacket of coaxial cable.
- Precision ground stripping hole easily removes inner dielectric insulation without damaging the center conductor.
- Two hex-crimping dies and a ring-crimping die quickly and accurately crimp connectors to coaxial cable.
- High carbon-steel body with black-oxide finish for corrosion resistance and durability.
- Yellow grips enhance comfort and visibility, and allow quick identification.



VDV010-019



Hex BNC Connector

HEX F Connector

Coax Cable

Coax Cable

R59	RG6
-----	-----

Cat. No.	Color	Type	Cable	Connectors	Overall Length	Weight (oz)
VDV010-019	yellow/black	cutter, stripper, hex-crimper	coaxial	BNC and F	8.5" (216 mm)	7.5

Cushion-Grip F-Connector Insertion/Extraction Tool

- 3/8"-32 Threaded end holds standard F-Connectors for cable insertion.
- 5" long shaft with 7/16" socket extends reach for connecting/removing F-connectors.
- Cushion-Grip handle for greater torque and enhanced comfort.
- Precision machined high-carbon steel is hardened for long life.
- Durable chrome finish resists corrosion and extends tool life.

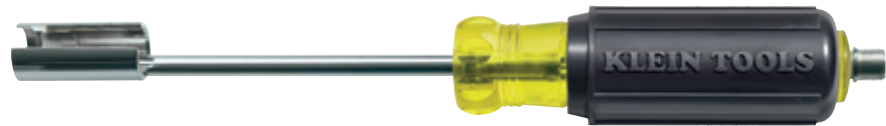

VDV312-012



F Connector

Cat. No.	Color	Shank Tip	Handle Tip	Shank Length	Finish	Overall Length	Weight (oz.)
VDV312-012	yellow/black	7/16" open socket	3/8"-32 threaded male F-connector	5" (127 mm)	chrome-plated	8.8" (222 mm)	7.5

All dimensions are in inches and (millimeters).

- ⚠WARNING:** Read carefully and understand instructions before using this tool.
- ⚠WARNING:** Always wear approved eye protection.

- ⚠WARNING:** NOT insulated. Will NOT protect against electrical shock.
- ⚠WARNING:** Never use on or near live electrical circuits.

Voice/Data/Video Tools

Ratcheting Crimper with Coaxial Hex-Crimp Die Set

- Professional CATV, Electrical, Home-Theater, Satellite and Security System crimper is perfect for fast, reliable connector installations.
- Precision full-cycle ratchet action assures complete precise crimp every cycle.
- Crimps meet or exceed UL Standards, where applicable.
- Steel body with black-oxide finish for corrosion resistance and durability.
- Preset tension for optimum performance.
- Dies manufactured from heat treated high-carbon steel for excellent performance and long life.
- Quick change interchangeable die-sets.
- Thumb-screws secure die-sets for quick easy changes. (Optional Phillips screws available, see table below.)
- Safety crimp release helps eliminate rejected terminations due to incorrect positioning.
- Ratchet mechanism is designed to prevent the release of the connector prior to full compression.
- Yellow and black grips enhance comfort, visibility, and allow quick identification.



VDV212-034



Hex BNC Connector



Coax Cable



HEX F Connector

VDV212-803

Cat. No.	Set Contains:	Overall Length	Weight (oz.)	
VDV212-803		8.8" (224 mm)	21.0	
Cat. No.	Description	Color	Nest Dimensions	Connector Type
VDV212-034	hex crimp RG59/6 coaxial cable F-connectors	black	0.255"/0.320"/0.350" 6.48/8.13/8.89 mm	hex crimp BNC hex crimp F

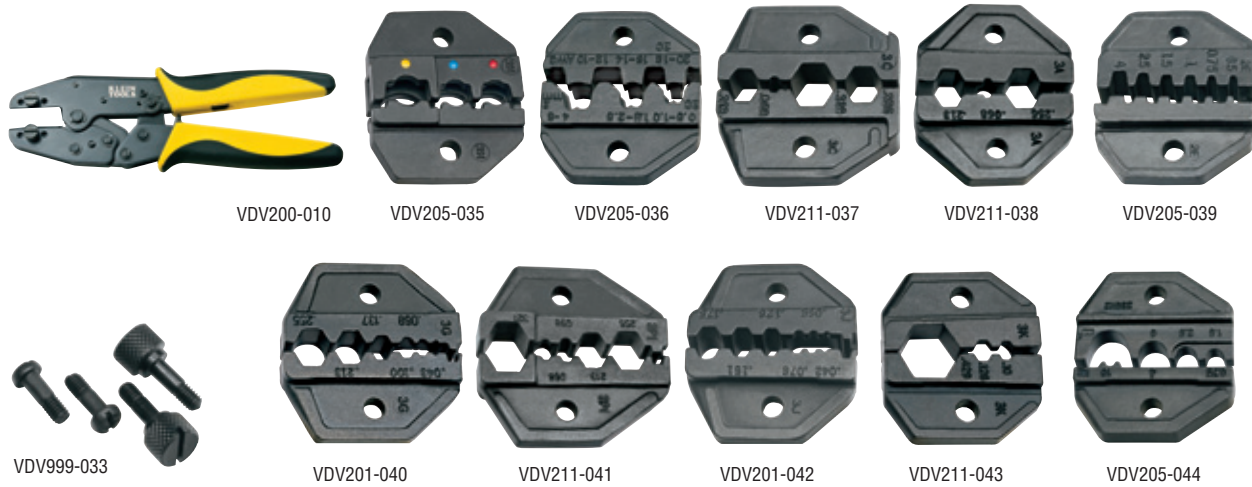

VDV200-010

VDV205-035

VDV205-036

VDV211-037

VDV211-038

VDV205-039

VDV999-033

VDV201-040

VDV211-041

VDV201-042

VDV211-043

VDV205-044

Cat. No.	Description	Nest Dimensions
VDV200-010	ratcheting crimper frame (yellow/black)	-
VDV999-033	replacement screw set (pair thumb and pair Phillips)	-
VDV212-034	hex crimp RG59/6 coaxial cable F-connectors	0.255"/0.320"/0.350" (6.48/8.13/8.89 mm)
VDV205-035	Insulated terminals, AWG 10-22	AWG 22-18/16-14/12-10 (DIN 0.5-1.0/1.5-2.5/4-6 mm ²)
VDV205-036	non-insulated terminal or open barrel terminal, AWG 10-20	AWG 20-18/16-14/12-10 (DIN 0.5-1/1.5-2.5/4-6 mm ²)
VDV211-037	hex crimp Connectors RG6/58/59/62 coaxial cable	0.256"/0.319"/0.068"/0.213" (6.50/8.10/1.73/5.41 mm)
VDV211-038	hex crimp RG58/59/62 coaxial cable	0.256"/0.068"/0.213" (6.50/1.73/5.41 mm)
VDV205-039	insulated pin terminal or non-insulated ferrules, AWG 12-22	AWG 22/20/18/16/14/12 (DIN 0.5/0.75/1.0/1.5/2.5/4 mm ²)
VDV201-040	RG58/59/62/174 coaxial cable and fiber optic	0.043"/0.068"/0.100"/0.137"/0.213"/0.255" (1.09/1.73/2.54/3.48/5.41/6.48 mm)
VDV211-041	RG58/59/62/6 coaxial cable	0.255"/0.213"/0.098"/0.068"/0.321" (6.48/5.41/2.49/1.73/8.15 mm)
VDV201-042	RG174/179/Belden 8218 coaxial cable and fiber optic	0.042"/0.068"/0.078"/0.128"/0.151"/0.178" (1.07/7.73/1.98/3.25/3.84/4.52 mm)
VDV211-043	RG8/11/174/179/213	0.100"/0.128"/0.429" (2.54/3.25/10.90 mm)
VDV205-044	non-insulated terminal, AWG 8-18	AWG 18-16/14/12-10/8 (DIN 0.75-1.5/2.54/4-6/10 mm ²)

All dimensions are in inches and (millimeters).

⚠WARNING: Read carefully and understand instructions before using this tool.

⚠WARNING: NOT insulated. Will NOT protect against electrical shock.

⚠WARNING: Always wear approved eye protection.

⚠WARNING: Never use on or near live electrical circuits.

Punchdown Multi-Tool

- Patent pending locking impact mechanism allows non-impact operation and sure driving with a variety of optional WorkEnds™ driver bits.
- Terminate and cut wire in one step with included precision ground combination 66 & 110 blade.
- Integrated Hook and Spudger for fast, easy manipulation of wire and small components.
- Selectable (Hi/Low) impact-force settings meet industry standards.
- Spring loaded for fast, low effort seating and terminating.
- Dual material contoured chassis provides greater control and enhances comfort.
- Blade storage compartment with spring loaded locking mechanism.
- Color coded yellow on the cut side of the tool.
- Hook and Spudger neatly and compactly store in the chassis, out of the way when not in use.
- Induction hardened high-carbon steel for durability and long life.
- Cat. No. VDV427-807 Includes WorkEnds™ Kit with WorkEnds™ adapter, reach extension, and 4 driver bits (#1 and #2 Phillips and 3/16" and 1/4" Slotted) in a convenient carrier.
- Replacement blades/accessories available.



VDV427-807



Twisted Pair Cable

Integrated Hook and Spudger for fast, easy manipulation of wire and small components.

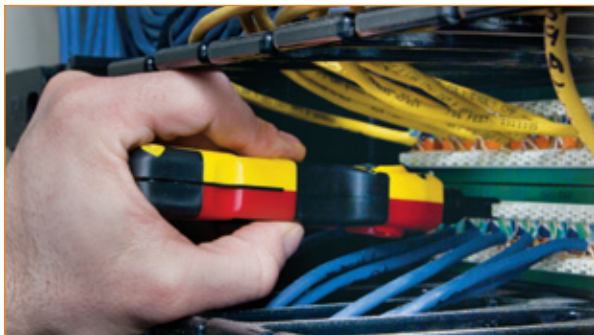

Cat. No	Set Contains	Overall Length	Weight (oz.)																				
VDV427-806	punchdown multi-tool with 110/66 blade	7.0" (176 mm)	5.6																				
	<table border="1"> <thead> <tr> <th>Cat. No.</th> <th>Color</th> <th>Description</th> <th>Blade Configuration End 1</th> <th>Blade Configuration End 2</th> </tr> </thead> <tbody> <tr> <td>VDV427-047</td> <td>yellow/red/black</td> <td>punchdown multi-tool chassis</td> <td>-</td> <td>-</td> </tr> <tr> <td>VDV427-017</td> <td>black</td> <td>punchdown tool blade - combination 66/110 cut type</td> <td>110 terminate & cut</td> <td>66 terminate & cut</td> </tr> </tbody> </table>	Cat. No.	Color	Description	Blade Configuration End 1	Blade Configuration End 2	VDV427-047	yellow/red/black	punchdown multi-tool chassis	-	-	VDV427-017	black	punchdown tool blade - combination 66/110 cut type	110 terminate & cut	66 terminate & cut							
Cat. No.	Color	Description	Blade Configuration End 1	Blade Configuration End 2																			
VDV427-047	yellow/red/black	punchdown multi-tool chassis	-	-																			
VDV427-017	black	punchdown tool blade - combination 66/110 cut type	110 terminate & cut	66 terminate & cut																			
VDV427-807	punchdown multi-tool with 110/66 blade & WorkEnds™	7.88" (200 mm)	7.5																				
	<table border="1"> <thead> <tr> <th>Cat. No.</th> <th>Color</th> <th>Description</th> <th>Blade Configuration End 1</th> <th>Blade Configuration End 2</th> </tr> </thead> <tbody> <tr> <td>VDV427-047</td> <td>yellow/red/black</td> <td>punchdown multi-tool chassis</td> <td>-</td> <td>-</td> </tr> <tr> <td>VDV427-017</td> <td>black</td> <td>punchdown tool blade - combination 66/110 cut type</td> <td>110 terminate & cut</td> <td>66 terminate & cut</td> </tr> <tr> <td>VDV770-050</td> <td>-</td> <td>WorkEnds™ kit</td> <td>-</td> <td>-</td> </tr> </tbody> </table>	Cat. No.	Color	Description	Blade Configuration End 1	Blade Configuration End 2	VDV427-047	yellow/red/black	punchdown multi-tool chassis	-	-	VDV427-017	black	punchdown tool blade - combination 66/110 cut type	110 terminate & cut	66 terminate & cut	VDV770-050	-	WorkEnds™ kit	-	-		
Cat. No.	Color	Description	Blade Configuration End 1	Blade Configuration End 2																			
VDV427-047	yellow/red/black	punchdown multi-tool chassis	-	-																			
VDV427-017	black	punchdown tool blade - combination 66/110 cut type	110 terminate & cut	66 terminate & cut																			
VDV770-050	-	WorkEnds™ kit	-	-																			

All dimensions are in inches and (millimeters).

⚠WARNING: Read carefully and understand instructions before using this tool.

⚠WARNING: NOT insulated. Will NOT protect against electrical shock.

⚠WARNING: Always wear approved eye protection.

⚠WARNING: Never use on or near live electrical circuits.

Voice/Data/Video Tools

Impact Punchdown Tools

- Terminate cable in variety of cross-connect panels, blocks and keystone jacks.
- Spring loaded for fast, low effort seating and terminating.
- Selectable (Hi/Low) impact-force settings meet industry standards.
- Rubber finger grips and boot provide greater control and enhanced comfort.
- Blade storage compartment with spring loaded locking mechanism.
- Color coded yellow on the cut side of the tool.
- Bayonet style (twist & lock) socket accepts most manufacturers' tools and blades.
- Induction-hardened high-carbon steel for durability and long life.
- Replacement blades available.



VDV427-800



Twisted Pair Cable

Cat. No.	Set Contains:				Overall Length	Weight (oz.)
VDV427-800					7.0" (177 mm)	5.7
Component No.	Color	Description	Blade Configuration End 1	Blade Configuration End 2		
VDV427-013	yellow/black	impact punchdown tool	-	-		
VDV427-017	black	punchdown tool blade - combination 66/110 cut type	66 terminate & cut	110 terminate & cut		

Cat. No.	Set Contains:				Overall Length	Weight (oz.)
VDV427-805					7.1" (180 mm)	5.6
Component No.	Color	Description	Blade Configuration End 1	Blade Configuration End 2		
VDV427-013	yellow/black	impact punchdown tool	-	-		
VDV427-015	black	punchdown tool blade - 110 type	110 terminate	110 terminate & cut		

Punchdown Tool Blades & Accessories

- Compatible with Impact Punchdown Tool (VDV427-013), Punchdown Multi-Tool (VDV427-047) and other bayonet style (twist & lock) socket punchdown tools.
- Terminate cable in variety of cross-connect panels, blocks and keystone jacks.
- Induction-hardened high-carbon steel for durability and long life.
- Reversible blades with termination/cutting ends and termination only ends (depending on blade type).
- Precision ground cutting-edge for clean, precise wire termination (depending on blade type).
- WorkEnds™ Kit converts the Punchdown Multi-Tool chassis (VDV427-047) into a multi-bit driver. Kit includes: WorkEnds™ adapter, reach extension, and 4 driver bits (#1 and #2 Phillips and 3/16" and 1/4" Slotted) in a convenient carrier.[†]



VDV427-015

VDV427-016



VDV427-017



VDV427-018

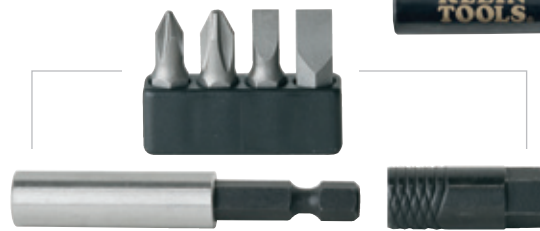

VDV770-050†



Twisted Pair Cable

Cat. No.	Color	Description	Blade Configuration End 1	Blade Configuration End 2	Overall Length	Weight (oz.)
VDV427-015	black	punchdown tool blade - 110 type	110 terminate	110 terminate & cut	2.1" (52 mm)	0.5
VDV427-016	black	punchdown tool blade - 66 type	66 terminate	66 terminate & cut	2.3" (58 mm)	0.6
VDV427-017	black	punchdown tool blade - combination 66/110 cut type	66 terminate & cut	110 terminate & cut	2.2" (56 mm)	0.6
VDV427-018	black	punchdown tool reach extension	bayonet style male	bayonet style female	2.6" (67 mm)	1.2
VDV770-050	-	WorkEnds™ adapter, reach extension, and 4 driver bits (#1 and #2 Phillips and 3/16" and 1/4" Slotted) in a convenient carrier [†]	proprietary magnetic hex	1/4" female hex	3.2" (81 mm)	1.4

[†]WorkEnds™ is not compatible with VDV427-013, VDV427-800, VDV427-805.

All dimensions are in inches and (millimeters).

⚠WARNING: Read carefully and understand instructions before using this tool.

⚠WARNING: NOT insulated. Will NOT protect against electrical shock.

⚠WARNING: Always wear approved eye protection.

⚠WARNING: Never use on or near live electrical circuits.

Voice/Data/Video Tools

Ratcheting Modular Crimper/Stripper

- Fast, reliable modular-crimp connector installation for voice and data applications.
- All-In-One Tool, cuts, strips and crimps paired-conductor cables (round STP/UTP and flat-satin phone cable).
- Crimps 4, 6, and 8 position modular connectors (RJ22, RJ11/RJ12 and RJ45).
- Crimping dies are precision ground from high-carbon steel.
- Designed for Western Electric (WE)/Stewart Stamping (SS)-type modular connectors.
- Ratchet safety-release and a blade-guard on cutting and stripping knives reduce risk of injury.
- Full-cycle ratchet mechanism prevents the release of the connector prior to full compression.
- Yellow and black grips enhance comfort, visibility, and allow quick identification.
- Three crimping dies:
8-position, 4-pair/8-conductor - RJ45
6-position, 2-pair/4-conductor - RJ11 & 3-pair/6-conductor - RJ12
4-position, 2-pair/4-conductor & 1-pair/2-conductor – headset RJ22.
- Cable parameters: 28-22 AWG (.08 - .34 mm²) flat or round; solid or stranded telephone & data.
- Not for use with AMP® connectors.
- Replacement blade set available (Cat. No. VDV999-064).



VDV226-011

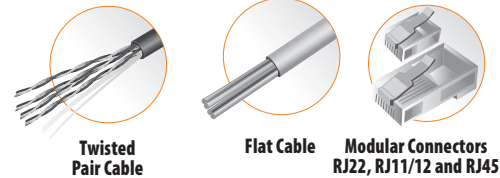

AMP® is a registered trademark of TYCO, Inc.

Cat. No.	Color	Cuts & Strips	Crimps Connectors	Position/Pair/ Conductors	Overall Length	Weight (oz.)
VDV226-011	yellow/black	round STP/UTP, flat satin phone cable 22-28 AWG (0.08 - 0.34 mm ²)	RJ11, RJ12 RJ22 and RJ45	4/1-2/2-4, 6/2-3/4-6, 8/4/8	7.5" (191 mm)	11.3

Connector Crimping Long-Nose Pliers

- Crimps URIUYIUG insulation displacement connectors (IDC) – Scotchlok® type connectors.
- Grooved jaws for wire wrapping, looping and twisting.
- Cleanly strips 23 AWG and 24 AWG wire.
- Hot-riveted joint ensures smooth action and no handle wobble.
- Induction hardened cutting knives for long life.
- Yellow plastic grips enhance comfort, visibility and allow quick identification.



VDV026-049

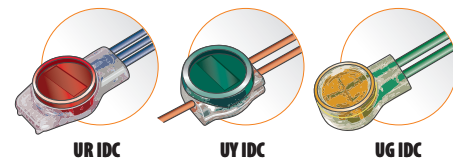

Scotchlok® is a registered trademark of 3M Corporation.

Cat. No	Overall Length	Jaw Length	Jaw Width	Jaw Thickness	Knife Length	Point Thickness	Handle Finish	Handle Color	Weight (oz.)
VDV026-049	6.80" (173 mm)	2.00" (51 mm)	0.70" (18 mm)	0.38" (10 mm)	0.44" (11 mm)	0.095 x 0.125 (2.0 x 3.0 mm)	plastic-dipped	yellow	4.5

Scotchlok® Connector Crimping Pliers

- Crimps and seats UG, UR, and UY connectors.
- Curved handles for greater control.
- Induction hardened side-cutting knives for long life.



D234-6

*Spring-loaded action for self-opening.
Scotchlok® is a registered trademark of 3M.

Cat. No.	Overall Length	Jaw Length	Jaw Width	Jaw Thickness	Knife Length	Handle Finish	Handle Color	Weight (lbs.)
D234-6	5-13/16" (148 mm)	1-3/32" (28 mm)	11/16" (18 mm)	3/8" (10 mm)	1/2" (13 mm)	plastic-dipped	yellow	.25
D234-6C*	5-13/16" (148 mm)	1-3/32" (28 mm)	11/16" (18 mm)	3/8" (10 mm)	1/2" (13 mm)	plastic-dipped	yellow	.25

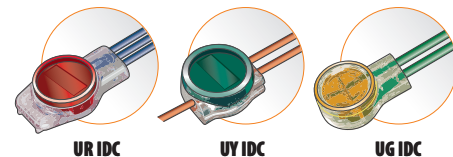

Voice/Data/Video Test



Voice/Data/Video Test

Coax Explorer™ Tester

- Tests and verifies coaxial cable continuity.
- Compact size fits easily into pocket or pouch.
- Bright LED indicates cable status (good/open/short).
- Simple push-button operation.
- Batteries included.



VDV512-057



Cat. No.	Batteries	Height	Width	Depth	Weight (oz.)
VDV512-057	lithium non-replaceable	2.7" (69 mm)	1.1" (28 mm)	0.7" (18 mm)	1.3 (37 g)

Coax Explorer™ Plus Tester

- Tests and verifies coaxial cable continuity.
- Identifies/maps up to 4 locations.
- Color coded remotes simplify identification.
- Compact size fits easily into pocket or pouch.
- Bright LED indicates status and location of cable.
- Simple push-button operation.
- Includes convenient remote holder.
- Batteries included.



VDV512-058



Cat. No.	Batteries	Height	Width	Depth	Weight (oz.)
VDV512-058	lithium non-replaceable	5.6" (142 mm)	1.1" (28 mm)	0.6" (16 mm)	3.3 (94 g)

LAN Scout™ Jr. Tester

- Tests continuity on twisted pair data wiring (RJ45) connections.
- Integrated tone generator supports multiple tones and control of pins carrying tone.
- Heavy-duty ports are designed for long life and repeated connections.
- Compact, contoured dual-material chassis fits comfortably in your hand.

Features	VDV526-052
RJ-45 8-wire Cables	•
Continuity Testing	•
Pass TIA-568A/B & Crossover/Uplink	•
LCD LCD Display	•
Wiremap	•
Open Fault	•
Short Fault	•
Miswire Fault	•
Split Pair Fault	•
Multiple Style Tone Generator	•
Apo Auto Power Off	•
Low Battery	•
Voltage Warning	•
Shield Detection	•
Self-Storing Remote	•



RJ45 Port



Self Storing Remote

VDV526-052



Cat. No.	Batteries	Height	Width	Depth	Weight (oz.)
VDV526-052	6V - 4 x LR44 alkaline included	4.6" (117 mm)	2.3" (58 mm)	1.1" (28 mm)	4.0 (115 g)

All dimensions are in inches and (millimeters).

⚠WARNING: Always wear approved eye protection.

⚠WARNING: Do NOT use on energized circuits.

Voice/Data/Video Test

VDV Scout™ Pro Tester Kit

- Tests continuity on data (RJ45), voice (RJ11/12) and video (F-Connector Coax) connections.
- Simultaneous testing of video and data cables saves time and improves efficiency.
- Includes location ID remotes for locating cable runs to wall outlets; five RJ45 Remotes & five F-Connector Remotes.
- Integrated tone generator supports multiple tones and control of pins carrying tone.
- Heavy-duty ports are designed for long life and repeated connections.
- Contoured dual-material chassis fits comfortably in your hand.
- Recessed F-Connector port for improved reliability.

Features	VDV501-809
RJ-45 8-wire Cables	●
RJ-11/12 6-wire Cables	●
F-connector Coax Cables	●
Continuity Testing	●
Pass TIA-568A/B & Crossover/Uplink	●
LCD LCD Display	●
Wiremap	●
Open Fault	●
Short Fault	●
Miswire Fault	●
Split Pair Fault	●
ID Cable Identification – Up to 19 Locations	Includes 5
Multiple Style Tone Generator	●
Apo Auto Power Off	●
Low Battery	●
Voltage Warning	●
Shield Detection	●
Self-Storage Remote	●



RJ45, F-Connector and RJ11/12 Port



Self Storing Remote



VDV501-809



Cat. No.	Batteries	Height	Width	Depth	Weight (oz.)	Included Accessories
VDV501-809	9V alkaline included	6.3" (160 mm)	2.8" (71.2 mm)	1.70" (43.2 mm)	9.0 (256 g)	5 location RJ45 remotes, 5 location F-Connector remotes, 1 F to F Barrel Connector, battery

LanMap™ Kit for VDV Scout™ Pro Tester

- Identify and map twisted-pair infrastructure (RJ45), up to 19 locations.
- For use with VDV Scout™ Pro Tester (Cat. No. VDV501-053, VDV501-809).
- Heavy-duty design for long life and repeated connections.
- Remotes numbered 1 through 19 for fast and accurate identification.

Cat. No.	Height	Width	Depth	Weight (oz.)
VDV526-055	3.0" (76 mm)	3.3" (84 mm)	1.4" (36 mm)	1.9 (56 g)



VDV526-055

CoaxMap™ Kit for VDV Scout™ Pro Tester

- Identify and map coaxial cable infrastructure (F-Connector), up to 19 locations.
- For use with VDV Scout™ Pro Tester (Cat. No. VDV501-053, VDV501-809).
- Heavy-duty design for long life and repeated connections.
- Remotes numbered 1 through 19 for fast and accurate identification.

Cat. No.	Height	Width	Depth	Weight (oz.)
VDV512-056	3.0" (76 mm)	3.3" (84 mm)	1.0" (26 mm)	5.2 (148 g)



VDV512-056

All dimensions are in inches and (millimeters).

⚠ WARNING: Always wear approved eye protection.

⚠ WARNING: Do NOT use on energized circuits.

Voice/Data/Video Test

TraceAll™ Tone & Probe

- Trace wire paths and identify cables in common wiring systems.
- Heavy-duty RJ11 jack on tone generator for long life and repeated connections.
- Includes RJ11 adapter to convert tone generator to an Alligator-clip configuration.
- Dual material chassis fits comfortably in your hand .
- Replacement tips available (Cat. No. VDV999-059).
- Replacement alligator-clip adapter available (Cat. No. VDV999-067).



VDV526-054

Features	VDV526-054
Adjustable volume	●
Tone generator, 2 Tones	●
Self-storing remote	●
Replaceable tip	●

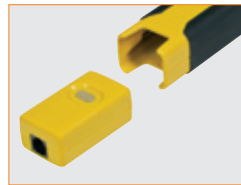

Self Storing Remote



Adapter



Cat. No.	Batteries	Height	Width	Depth	Weight (oz.)	Included Accessories
VDV526-054	6V – 4 x LR44 alkaline included	8.9" (226 mm)	1.7" (43 mm)	1.2" (31 mm)	5.0 (140 g)	RJ11 to, alligator clip adapter, batteries

TONEcube & PROBEplus Kit

- Trace wire paths and identify cables in common wiring systems.
- TONEcube Tone Generator.
- PROBEplus Tone Tracing Probe.
- Nylon carrying case with belt loop and D-ring.



VDV500-808

Cat. No.	Set Contains:	Overall Length	Weight (oz.)				
VDV500-808		10.5" (267 mm)	12.8 (363 g) without batteries 16.0 (454 g) with batteries				
Cat. No.	Description	Batteries	Battery Life	Height	Width	Depth	Weight
VDV500-051	TONEcube	9V	25 hours active 4 years standby	2.7" (70 mm)	2.5" (63 mm)	1.42" (36 mm)	3.4 (96 g) without battery 5.0 (142 g) with battery
VDV500-060	PROBEplus	9V	25 hours active 4 years standby	9.9" (252 mm)	2.00" (51 mm)	1.14" (29mm)	4.4 (125 g) without battery 6.0 (170 g) with battery
-	nylon pouch			10.5" (267 mm)	4.75" (121 mm)	2.25" (57 mm)	4.8 (136 g)

All dimensions are in inches and (millimeters).

⚠WARNING: Always wear approved eye protection.

⚠WARNING: Do NOT use on energized circuits.

Voice/Data/Video Test

TONEcube – Tone Generator

- Trace wire paths and identify cables in common wiring systems.
- Five discrete tracing tones.
- Constant output level over useful battery life.
- Heavy-duty leads with rugged dual-mode modular plug for direct connection to both RJ11 & RJ45 jacks.
- Momentary slide switches prevent accidental operation.
- Designed for use with Klein Tools VDV test tools (Cat. No. VDV526-054, VDV500-060).
- Works with many other manufacturers' analog tone probes.



VDV500-051



Cat. No.	Batteries	Battery Life	Height	Width	Depth	Weight (oz.)
VDV500-051	9V	120 hours active 4 years standby	2.7" (70 mm)	2.5" (63 mm)	1.42" (36 mm)	3.4 (96 g) without battery 5.0 (142 g) with battery

Features	VDV500-051
Tones	high-warble, low-warble, mono, ascending, descending
Heavy-Duty Leads	●
Rugged RJ11/RJ45 Modular Plug	●
Continuity Testing	●
O.L. Voltage Overload Protection	●
+/- Line Status & Polarity	●
Power-On Flashing LED Indicator	●
Apo Auto Power-Off	●
Low Battery Indicator	●
Lanyard Attachment Loop	●

PROBEplus – Tone Tracing Probe

- Trace wire paths and identify cables in common wiring systems.
- Amplifier overload LED improves accuracy, warning against misreads.
- Dual mode power button with Power-On LED indicator – tap or hold.
- Recessed buttons prevent accidental operation.
- Designed for use with Klein Tools VDV test tools (Cat. No. VDV500-051, VDV526-054, VDV526-052, VDV501-053, VDV501-809).
- Works with many other manufacturers' analog tone generators.
- Replacement tips available (Cat. No. VDV999-065).



VDV500-060



Cat. No.	Batteries	Battery Life	Height	Width	Depth	Weight (oz.) without battery
VDV500-060	9V	25 hours active 4 years standby	9.9" (252 mm)	2.0" (50 mm)	1.14" (29 mm)	4.4 (112 g) 6.0 (152 g)

Features	VDV500-060
O.L. Amplifier Overload Indication	●
Adjustable digital sensitivity control	●
Tap-Mode Operation	●
Hold-Mode Operation	●
Power-On LED Indicator	●
Visual Notification	●
Apo Auto Power-Off	●
Low Battery Indicator	●
Replaceable Tip	●
Lanyard Attachment Loop	●

All dimensions are in inches and (millimeters).

⚠WARNING: Always wear approved eye protection.

⚠WARNING: Do NOT use on energized circuits.

Voice/Data/Video Tools



Cushion-Grip Screwdriver Sets

4-Piece Miniature Cushion-Grip Screwdriver Set

Additional Feature:

- Precision tips for exact fit and rigorous applications.

Cat No.	Set Contains	Weight (lbs.)
85484		.14

Cat. No.	Tip Type Size	Shank Tip Size	Shank Length	Overall Length
604-3	Phillips	No. 0	3" (76 mm)	5-3/4" (146 mm)
606-2	keystone	1/16" (1.6 mm)	2" (51 mm)	4-3/4" (121 mm)
607-3	cabinet	3/32" (2.4 mm)	3" (76 mm)	5-3/4" (146 mm)
608-3	cabinet	1/8" (3.2 mm)	3" (76 mm)	5-3/4" (146 mm)



85484

4-Piece Cushion-Grip Screwdriver Set

Additional Features:

- The screwdrivers Professionals carry most often.
- Includes one Phillips-tip, two keystone-tip, one cabinet-tip screwdrivers.

Cat. No.	Set Contains	Weight (lbs.)
85105		1.50

Cat. No.	Description	Blade Length	Overall Length
603-4	round-shank, No. 2 Phillips-tip	4" (102 mm)	8-5/16" (211 mm)
600-4	square-shank, keystone-tip*	4" (102 mm)	8-11/32" (212 mm)
601-6	round-shank, cabinet-tip	6" (152 mm)	9-3/4" (248 mm)
600-6	square-shank, keystone-tip*	6" (152 mm)	10-15/16" (278 mm)



85105

All dimensions are in inches and (millimeters).

⚠WARNING: NOT insulated. Will NOT protect against electrical shock.

⚠WARNING: Always wear approved eye protection.

⚠WARNING: Do NOT use to pry or chisel.

Cushion-Grip Screwdriver Sets

7-Piece Cushion-Grip Screwdriver Set

Additional Features:

- General-purpose selection of the most frequently used screwdrivers.
- Includes three cabinet-tip, two Phillips-tip and two keystone-tip styles.

Cat. No.	Set Contains	Weight (lbs.)	
85076		1.50	
Cat. No.	Description	Blade Length	Overall Length
600-4	square-shank, keystone-tip*	4" (102 mm)	8-11/32" (212 mm)
602-6	round-shank, keystone-tip*	6" (152 mm)	10-15/16" (278 mm)
601-3	round-shank, cabinet-tip	3" (76 mm)	6-3/4" (171 mm)
601-6	round-shank, cabinet-tip	6" (152 mm)	9-3/4" (248 mm)
605-4	round-shank, cabinet-tip*	4" (102 mm)	8-11/32" (212 mm)
603-3	round-shank, No. 1 Phillips-tip	3" (76 mm)	6-3/4" (171 mm)
603-4	round-shank, No. 2 Phillips-tip	4" (102 mm)	8-5/16" (211 mm)

* Heavy-duty models



85076

8-Piece Cushion-Grip Screwdriver Set

Additional Features:

- General-purpose selection of the most frequently used screwdrivers.
- Includes one cabinet-tip, three keystone-tip, four Phillips-tip styles.

Cat. No.	Set Contains	Weight (lbs.)	
85078		1.65	
Cat. No.	Description	Shank Length	Overall Length
600-1	round-shank, keystone-tip	1-1/2" (38 mm)	3-7/16" (87 mm)
601-3	round-shank, cabinet-tip	3" (76 mm)	6-3/4" (171 mm)
600-4	square-shank, keystone-tip*	4" (102 mm)	8-11/32" (212 mm)
602-6	round-shank, keystone-tip*	6" (152 mm)	10-15/16" (278 mm)
603-1	round-shank, No. 2 Phillips-tip	1-1/2" (38 mm)	3-7/16" (87 mm)
603-3	round-shank, No. 1 Phillips-tip	3" (76 mm)	6-3/4" (171 mm)
603-4	round-shank, No. 2 Phillips-tip	4" (102 mm)	8-5/16" (211 mm)
603-6	round-shank, No. 3 Phillips-tip	6" (152 mm)	11" (279 mm)

* Heavy-duty models



85078

4-Piece Square Recess Cushion-Grip Screwdriver Set

Additional Features:

- Color-coded handle ends with Tip-Ident® for quick and easy identification.
- Round shank with square-recess tip.
- Chrome-plated shank for corrosion resistance.
- Cushion-grip handle for greater torque and comfort.
- Works on most combination head receptacle, switch and panel screws.

Cat. No.	Set Contains	Weight (lbs.)		
85664		1.50		
Cat. No.	Point Size	Color Code	Shank Length	Overall Length
660	No. 0	yellow	4" (102 mm)	7-3/4" (197 mm)
661	No. 1	green	4" (102 mm)	7-3/4" (197 mm)
662	No. 2	red	4" (102 mm)	8-5/16" (211 mm)
663	No. 3	black	4" (102 mm)	8-5/16" (211 mm)



85664

All dimensions are in inches and (millimeters).

⚠ WARNING: NOT insulated. Will NOT protect against electrical shock.

⚠ WARNING: Always wear approved eye protection.

⚠ WARNING: Do NOT use to pry or chisel.

Cushion-Grip Screwdrivers

5-Piece TORX® Cushion-Grip Screwdriver Set

Additional Features:

- Color-coded handle ends with Tip-Ident® for quick and easy identification.
- TORX® drive systems transmit more torque to the work and reduce slippage, saving fasteners.
- Chrome plated shank for corrosion resistance.
- Cushion-grip handle for greater torque and comfort.

Cat. No.	Set Contains	Weight (lbs.)		
19555		1.20		
Cat. No.	TORX® Size	Color Code	Shank Length	Overall Length
19542	T15	yellow	4" (102 mm)	7-3/4" (197 mm)
19543	T20	green	4" (102 mm)	7-3/4" (197 mm)
19544	T25	blue	4" (102 mm)	7-3/4" (197 mm)
19545	T27	brown	4" (102 mm)	8-5/16" (211 mm)
19546	T30	red	4" (102 mm)	8-5/16" (211 mm)



19555

TORX® is a registered trademark of Acument Intellectual Properties, LLC.

2-Piece Stubby Screwdriver Set

Additional Feature:

- Double wings inside handle provide solid, twist-resistant blade anchor.

Cat. No.	Set Contains	Weight (lbs.)	
85071		.30	
Cat. No.	Description	Shank Length	Overall Length
600-1	round-shank, keystone-tip	1-1/2" (38 mm)	3-7/16" (87 mm)
603-1	round-shank, Phillips-tip	1-1/2" (38 mm)	3-7/16" (87 mm)



85071

Interchangeable Rapi-Driv®

- The original Klein Cushion-Grip handle for superior comfort and torque!
- Interchangeable bit holder allows quick switching between tip styles and works with other standard size bits.
- Crank action handle allows you to spin screws fast with one hand.
- Blast finish bit provides firm grip on fasteners to reduce cam out.

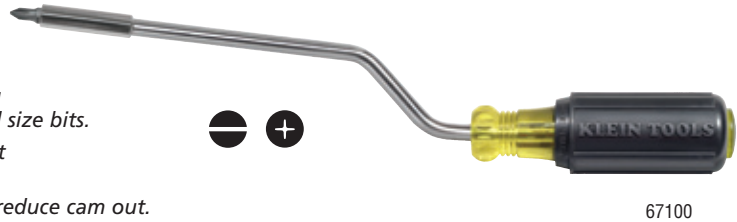

67100

Cat. No.	Contains	Shaft Length	Overall Length	Weight (lbs.)
67100	3/16" slotted, #2 Phillips	6"	9-3/4"	.26

2-in-1 Replacement Bit

Cat. No.	Fits	Description	Quantity	Weight (lbs.)
67101	2-in-1 Rapi-Driv®, 10-in-1, 11-in-1 and 10-Fold™	3/16" slotted, #2 Phillips replacement bit	contains 2 bits	.012

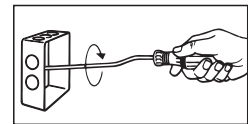

Specialty Screwdrivers

5-in-1 Screwdriver/Nut Driver

Additional Feature:

- End of handle is marked to quickly identify tool.

Cat. No.	Contains	Weight (lbs.)
32476	5/16" nut driver, #1 and #2 Phillips, 9/32" slotted and 3/16" slotted	.35



32476



All dimensions are in inches and (millimeters).

WARNING: Always wear approved eye protection.

WARNING: NOT insulated. Will NOT protect against electrical shock.

WARNING: Do NOT use to pry or chisel.

Specialty Screwdrivers

11-in-1 Screwdriver/Nut Driver

Additional Feature:

- Integrated screwdriver/nut driver shaft holds 8 popular tips and converts to 3 nut driver sizes.
- End of handle is marked to quickly identify tool.



32500

Cat. No.	Contains	Weight (lbs.)
32500	3/8", 5/16" and 1/4" nut drivers, #1 and #2 Phillips, 1/4" and 3/16" slotted, T10 and T15 TORX®, #1 and #2 square-recess	.44

Magnetic Screwdriver with 32-Piece Tamperproof Bit Set

- Cushion-Grip handle for superior torque and comfort.
- Sturdy bit and screw holding magnet allows for screws to fit securely in place for easy use.
- Includes complete tamperproof bit set in block.



32510

Cat. No.	Set Contains	Weight (lbs.)
32510		.71

Non-Ratcheting Magnetic Screwdriver w/ 32 Piece Tamperproof Bit Set

Bits Included

- TORX® – T7, T8, T10, T15, T20, T25, T27, T30 and T40
- Fraction Hex – 3/32", 7/64", 1/8", 9/64", 5/32", and 3/16"
- Metric Hex – 2 mm, 2.5 mm, 3 mm, 4 mm, and 5 mm
- Spanner – 4, 6, 8, and 10
- Tri-Wing® – 1, 2, 3 and 4
- TORQ-SET® – 6, 8 and 10
- 1/4" square to 1/4" hex adapter to drive sockets



TORX® is a registered trademark of Acument Intellectual Properties, LLC. TORQ-SET® and Tri-Wing® are registered trademarks of Phillips Screw Co.

Magnetic Screwdriver Bit Sets

32-Piece Standard Tip Bit Set

- Durable PVC black block allows for easy storage of standard bits.
- Block slides over most screwdriver shafts for easy bit access and storage.
- Industrial strength, heat treated steel bits for long lasting use.

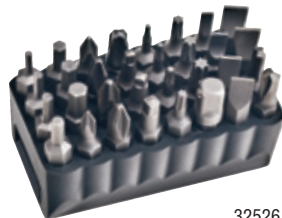

32526

Cat. No.	Set Contains	Weight (lbs.)
32526		.425

Bits Included

- Hex – 5/64", 3/32", 7/64", 1/8", 9/64", 5/32" and 3/16"
- Phillips – #0, #1, #2 (Qty. 3), and #3
- Square Recess – #1, #2, and #3
- TORX® – T6, T7, T8, T10, T15, T20 and T25
- Slotted – 3-4, 5-6, 6-8, 8-10, 10-12, 12-14 screw sizes
- Clutch – 5/32" and 3/16"
- 1/4" square to 1/4" hex adapter to drive sockets

TORX® is a registered trademark of Acument Intellectual Properties, LLC. TORQ-SET® and Tri-Wing® are registered trademarks of Phillips Screw Co.

32-Piece Tamperproof Tip Bit Set

- Durable PVC gray block allows for easy storage of tamperproof bits.
- Block slides over most screwdriver shafts for easy bit access and storage.
- Industrial strength, heat-treated steel bits for long lasting use.



32525

Cat. No.	Set Contains	Weight (lbs.)
32525		.425

Bits Included

- TORX® – T7, T8, T10, T15, T20, T25, T27, T30 and T40
- Fraction Hex – 3/32", 7/64", 1/8", 9/64", 5/32", and 3/16"
- Metric Hex – 2 mm, 2.5 mm, 3 mm, 4 mm, and 5 mm
- Spanner – 4, 6, 8, and 10
- Tri-Wing® – 1, 2, 3 and 4
- TORQ-SET® – 6, 8 and 10
- 1/4" square to 1/4" hex adapter to drive sockets

All dimensions are in inches and (millimeters).

⚠WARNING: NOT insulated. Will NOT protect against electrical shock.

⚠WARNING: Always wear approved eye protection.

⚠WARNING: Do NOT use to pry or chisel.

Specialty Screwdrivers

10-in-1 Folding Screwdriver/Nut Driver

10-FOLD™

- Conveniently folds up for easy storage or fit into your pocket.
- Each driver arm contains four interchangeable bit styles and two nut drivers.
- Unfold each driver arm up to a full 180° for straight on driving power, or at 90° for extra leverage on stubborn fasteners.
- The quick release button easily unlocks a fully extended driver arm.



TORX®



32536

TAMPERPROOF TORX®



32537

FRACTIONAL HEX



32538

METRIC HEX



32539

Cat. No.	Handle Color	Description	Weight (lbs.)
32535	black	5/16" & 1/4" nut drivers, #1 and #2 Phillips, 1/4" & 3/16" slotted, T10 & T15 TORX®, and #1 and #2 square-recess	0.37
32536	green	5/16" & 1/4" nut drivers, T6, T7, T8, T10, T15, T20, T25, T27 Torx®	0.37
32537	green	5/16" & 1/4" nut drivers, T7, T8, T9, T10, T15, T20, T25, T27 Torx®	0.37
32538	red	5/16" & 1/4" nut drivers, 1/16", 5/64", 3/32", 7/64", 1/8", 9/64", 5/32", 3/16" standard hex	0.37
32539	blue	5/16" & 1/4" nut drivers, .9 mm, 1.3 mm, 1.5 mm, 2 mm, 2.5 mm, 3 mm, 4 mm, 5 mm metric hex	0.37

TORX® is a registered trademark of Acument Intellectual Properties, LLC.

Tapping Tools and Awls

Cushion-Grip Triple Taps and Six-in-One Tap Tool

- Quickly forms new threads, re-forms burred threads, and cleans out plaster obstructions.
- Each tap size rethreads to next larger size if threads are stripped.



626

Cat. No.	Tap Sizes	Overall Length	Weight (lbs.)
623-20	Triple Tap 10-24, 12-24, 1/4-20	7-3/4"	.25
623-24	Triple Tap 6-32, 8-32, 10-24	7-3/4"	.25
623-32	Triple Tap 6-32, 8-32, 10-32	7-3/4"	.25
626	6-in-1 Tap 6-32, 8-32, 10-32, 10-24, 12-24, 1/4-20	7-3/4"	.25

Replacement Taps		
628-20	10-24, 12-24, 1/4-20	replacement for 623-20, 626
626-24	6-32, 8-32, 10-24	replacement for 623-24
626-32	6-32, 8-32, 10-32	replacement for 623-32, 626

Cushion-Grip Scratch Awl



650

- Professional, heavy-duty, hard-pointed awl.
- Scribes metal, starts screw holes, performs a variety of piercing and punching jobs.
- Rigid, chrome-plated, heat-treated, tempered-steel shank has full reinforcing bolster at handle for extra strength and for handle impact reinforcement.
- Internal flanges provide solid shank anchor.
- Cushion-Grip handle allows for greater comfort.

Cat. No.	Blade Length	Overall Length	Weight (lbs.)
650	3-1/2" (89 mm)	7-7/8" (200 mm)	.25

⚠WARNING: Do NOT hammer on tool.

Steel Scratch Awl



66385

- One-piece forged-steel blade and bolstered shank.
- Heat treated for long life.
- Well-balanced for top efficiency during use.
- Black finish for rust resistance.

Cat. No.	Blade Length	Overall Length	Weight (lbs.)
66385	3-1/2" (89 mm)	7" (178 mm)	.30

⚠WARNING: NOT insulated. Will NOT protect against electrical shock.

All dimensions are in inches and (millimeters).

⚠WARNING: Always wear approved eye protection.

⚠WARNING: Do NOT use to pry or chisel.

Spring Tool Set

2-Piece Recessed Can Light Tool Set

- Contains the two tools needed for finishing can light installations in record time.
- Long reach, spring tool (Cat. No. ST6) makes attaching difficult springs easy.
- Compact, stubby nut driver (Cat. No. 610-1/4) even fits in smaller cans to tighten hard to reach ceiling height adjustment screws.
- Cushion-Grip handles for greater torque and comfort.

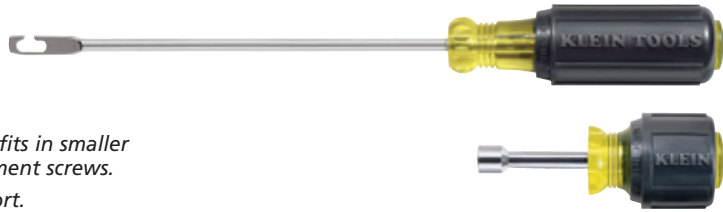

65020

Cat. No.	Set Contains	Weight (lbs.)
65020		.36

Cat. No.	Description	Shank Length	Overall Length
ST6	6' spring tool	6" (152 mm)	9-3/4" (248 mm)
610-1/4	1/4" stubby nut driver	1-1/2" (38 mm)	3-1/2" (89 mm)

⚠WARNING: NOT insulated. Will NOT protect against electrical shock.

⚠WARNING: Do NOT use to pry or chisel.

Telecom Tools

Can Wrench



68005

- One end opens telephone box fasteners, the other end tightens nuts on binding-post terminals.
- The 7/16" socket has a black finish and the 3/8" socket has a silver finish.
- Heat-treated, alloy steel.
- Sockets are 1-1/4" (32 mm) deep to fit over long binding posts and are thin-walled for easy access into tight areas.
- Socket ends are color-coded for quick identification of socket sizes.
- Hex-socket design enables using a wrench to obtain extra torque.

Cat. No.	Description	Length	Handle Diameter	Weight (lbs.)
68005	3/8" and 7/16" hex nut	7" (178 mm)	1" (25 mm)	.350

⚠WARNING: Read carefully and understand instructions before using this tool.

⚠WARNING: Always wear approved eye protection.

Bell System Type



3146B

- Similar to standard lineman's wrench, but with end openings sized to NEMA hardware specifications.
- Silver painted finish.

Cat. No.	Description	Length	Weight (lbs.)
3146B	Large end has 1-1/16" and 1-3/16" openings. Small end has 11/16" and 7/8" openings.	13" (330 mm)	1.76

⚠WARNING: NOT insulated. Will NOT protect against electrical shock.

⚠WARNING: Never use on or near live electrical circuits.

Saws & Blades

Jab Saw

- Cuts drywall, wallboard, plywood, and plastic.
- Triple ground teeth for a fast cut.
- Blade cuts in both directions (push and pull).
- Hardened, carbon steel blade for durability.
- Hardened, beveled blade point for scoring and plunge cuts.
- Comfort cushion grip with thumb groove.
- Handle structure designed for strength and durability.
- Flat-end grip for palming or punching through drywall.



725

Cat. No.	Blade Length	Overall Length	Weight (lbs.)
725	6" (152 mm)	12" (305 mm)	.31

⚠WARNING: Never use blade as a prying device as blades may break & cause injury.

All dimensions are in inches and (millimeters).

⚠WARNING: Always wear approved eye protection.

⚠WARNING: Never use on or near live electrical circuits.

Fish Tapes

High Strength 1/4" Wide Steel Fish Tapes



Additional Features:

- Permanent, laser etched 1' increments on the tape allow you to more accurately measure the depth of conduit runs and determine the amount of tape left to pay out.
- Tempered, high quality tape keeps its stability as it glides between surfaces for effective pushing and pullings of wire under carpets, through insulated walls and over suspended ceilings.
- 25' length is perfect for short wire runs associated with light commercial, residential and VDV installations (Cat. No. 56005).



56005

56005 Has a No Snag Plastic Tip



1' Permanent Laser Etched Descending Increments.

Cat. No.	Tape Size	Reel Diameter	Weight (lbs.)
56005	25' L x 1/4" W x .030" H (7 m L x 6.3 mm W x .7 mm H)	7" (178 mm)	1.1
56006	100' L x 1/4" W x .062" H (30 m L x 6.3 mm W x 1.5 mm H)	13" (330 mm)	6.8

Fish Tape Accessories

Glow Rods



- Use to install wires above ceilings, through walls and under carpets and raised floors.
- Luminescent rods glow in the dark and are rechargeable in most available light sources.
- 3/16" diameter Glow Rods are extremely flexible to navigate tight bends and narrow openings.
- Connect individual sections end-to-end to create a variety of lengths.
- Threaded connectors are beveled on both ends to prevent snagging and hang ups on obstructions.
- Cat. No. 56109, features 2 permanently affixed bull nose tips and offers the ultimate in flexibility.

56102

Cat. No.	Description	Set Contains	Material	Max. Diameter	Weight (lbs.)
56102	15' (4.5 m) glow rod set	(3ea.) 3/16" x 5' (4.8 mm x 1.5 m) glow rods (1ea.) bull nose attachment (1ea.) hook attachment	luminescent fiberglass	3/16" (4 mm)	1.0
56109	6' (1.8 m) glow rod	-	luminescent fiberglass	5/32" (3 mm)	.09
56114	10 pc. bulk 5' (1.5 m) glow rods	-		3/16" (4 mm)	.2

3-Piece Fish and Glow Rod Attachment Set

- Whisk attachment helps guide rods over obstructions and can roll side-to-side to help "steer" left or right.
- Hook attachment helps grab and retrieve wires or other objects from a distance.
- Compatible with both 1/4" and 3/16" rod sizes.

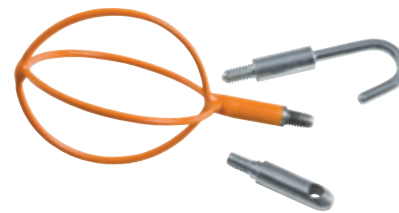

56104

Cat. No.	Set Contains	Weight (lbs.)
56104	(1ea.) whisk attachment (1ea.) bull nose attachment (1ea.) hook attachment	.1

All dimensions are in inches and (millimeters) unless otherwise specified.

⚠WARNING: Wear approved eye protection when feeding, pulling or rewinding fish tape.

⚠WARNING: Never remove screws while fish tape is coiled inside reel.

⚠WARNING: Do NOT use any fish tape on or near live circuits. Use extreme caution when working near any electrical equipment.

⚠WARNING: Use a safe work position to avoid loss of balance when using fish tape.

Fish Tape Accessories

Fish Rods



- Use to install wires above ceilings, through walls and under carpets and raised floors. 56100
- 1/4" diameter Fish Rods are flexible, yet provide excellent rigidity for extended distance stand out.
- Connect individual sections end-to-end to create a variety of lengths.
- Threaded connectors are beveled on both ends to prevent snagging and hang ups on obstructions.
- Sets contain (1ea.) steel "bullnose" and (1ea.) "J" hook accessory for attaching wires.
- Cat. No. 56103 includes (1ea. X 3/16") 5' Glow Rod section to help guide Fish Rods into dark spaces.

Cat. No.	Description	Set Contains	Material	Max. Diameter	Weight (lbs.)
56100	12' (3.6 m) fish rod set	(3ea.) 1/4" x 4' (6.3 mm x 1.2 m) fish rods (1ea.) bull nose attachment (1ea.) hook attachment	fiberglass	1/4" (6 mm)	1.2
56101	24' (7.3 m) fish rod set	(4ea.) 1/4" x 6' (6.3 mm x 1.8 m) fish rods (1ea.) bull nose attachment (1ea.) hook attachment	fiberglass	1/4" (6 mm)	2.2
56103	25' (7.6 m) fish and glow rod set	(5ea.) 1/4" x 4' (6.3 mm x 1.2 m) fish rods (1ea.) 3/16" x 5' (4.8 mm x 1.5 m) glow rod (1ea.) bull nose attachment (1ea.) hook attachment	fiberglass and luminescent rods	1/4" (6 mm)	2.7
56111	10 pc. bulk 4' (1.2 m) fish rods	-	fiberglass	1/4" (6 mm)	.2
56112	10 pc. bulk 6' (1.8 m) fish rods	-	fiberglass	1/4" (6 mm)	.2

Extension Pole – WireSpanner™



- Push/Pull wires over long spans of suspended ceilings, sub-floors, crawl spaces and attics. 56105
- The durable 54" pole quickly and easily telescopes to a maximum of 22' long.
- Each section locks securely into place and will not spin loose or collapse.
- High quality, rigid fiberglass is sturdy, lightweight and slides easily over obstructions.
- Large capacity hook/skid tip pulls multiple wires easily and has a separate eyelet for wire tie-on

Cat. No.	Description	Collapsed Length	Extended Length	Max. Diameter	Weight (lbs.)
56105	WireSpanner™ installation tool	54" (1.3 m)	22' (6.7 m)	2" (50 mm)	4
56118	WireSpanner™ carry case	-	-	-	0.4

Flexible Drill Bits

Flex Bit Placement Tool

- Folding design stores more compactly than standard tool.
- Cushion grip handle for non-slip comfort.
- For use with flexible drill bits.
- Positions flexible drill bits horizontally or vertically within a wall.



53715

Cat. No.	Length	Weight (lbs.)
53715	11" (279 mm)	1.00

All dimensions are in inches and (millimeters) unless otherwise specified.

▲WARNING: Wear approved eye protection when feeding, pulling or rewinding fish tape.

▲WARNING: Never remove screws while fish tape is coiled inside reel.

▲WARNING: Do NOT use any fish tape on or near live circuits. Use extreme caution when working near any electrical equipment.

▲WARNING: Use a safe work position to avoid loss of balance when using fish tape.

Flexible Drill Bits

Flex Bit Augers



- Used to drill holes through wood within a wall.
- Tapered back for easy bit retrieval.
- Spring steel shaft resists deformation.
- Screw point tip pulls the bit through wood.
- Hole in tip allows for use with wire or cable pulling grip.

Cat. No.	Length	Weight (lbs.)
53716	3/8" x 54" (9.5 mm x 1372 mm)	1.00
53717	3/8" x 72" (9.5 mm x 1829 mm)	1.00
53718	9/16" x 54" (14 mm x 1372 mm)	1.00
53719	3/4" x 54" (19 mm x 1372 mm)	2.00
53751	3/4" x 72" (19 mm x 1829 mm)	2.00
53720	1" x 54" (25 mm x 1829 mm)	2.00



53719



53720



53719



53718



53716

Flex Bit Extensions



- Connects to the end of a flex bit and extends the length.
- For use with flex bits 3/4" and larger (Cat. No. 53722).
- Connection diameter is 5/8" (Cat. No. 53722).
- For use with flex bits 9/16" and smaller (Cat. No. 53723).
- Connection diameter is 7/16" (Cat. No. 53723).

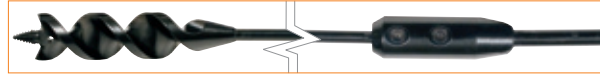

53722

Cat. No.	Length	Connection Diameter	Weight (lbs.)
53722	54" (1372 mm)	5/8" (14 mm)	1.00
53723	54" (1372 mm)	7/16" (11 mm)	1.00

Pulling Grips

Pulling Grips

- Clips to flex bit for pulling wire and cable.
- Grip (Cat. No. KPS050) is used to pull up to 9/16" diameter wire, cable or fish tape through walls; grip (Cat. No. KPS075) up to 1".
- Pulling grip attaches to the hole in the tip of the flex bit; wire mesh holds the wire during the pull.
- Swivel end helps reduce twisting.



KPS075

Cat. No.	Capacity	Maximum Safe Load	Weight (lbs.)
KPS050	1/2" - 9/16" (12 mm - 14 mm)	100 lb	1.00
KPS075	3/4" - 1" (19 mm - 25 mm)	185 lb	1.00

⚠WARNING: Do not exceed maximum safe load as listed on the label attached to the product.

⚠WARNING: Always match proper size and type of grip to application.

⚠WARNING: Always inspect equipment before use.

Flex Bit Kit

Flex Bit Kit

- 3 piece kit includes folding placement tool, 1/2"-9/16" O.D. pulling grip and 9/16" x 54" flexible drill bit.
- Everything you need to pull up to 9/16" O.D. wire.
- Complete kit used for drilling and pulling wire and cable.
- Use placement tool (Cat. No. 53715) to guide bit through walls.
- Flexible drill bit (Cat. No. 53718) makes 9/16" holes in wood.
- Pulling grip (Cat. No. KPS050) attaches to the flexible drill bit after the hole has been made and pulls 1/2" - 9/16" wire and cable.

Cat. No.	Kit Contains	Weight (lbs.)
53721		2.00
Cat. No.	Description	
53715	flex bit placement tool	
53718	flex drill bit - 9/16" x 54" (14 mm x 1372 mm)	
KPS050	pulling grip - 1/2"-9/16" (12 mm - 14 mm)	



53721

All dimensions are in inches and (millimeters) unless otherwise specified.

⚠WARNING: Always wear approved eye protection.

⚠WARNING: Never use on or near live electrical circuits.

NOTE: Read and follow safety instructions in power tool owner's manual.

Hole Saw Kits

Hole Saw Kits **GREAT WHITE®**

Master Electrician's Hole Saw Kit

- Includes the most commonly used saws and arbors.
- All components are packed in a metal carrying case.

Cat. No.	Set Contains	Weight (lbs.)
31640		8.10
	Hole Saws	Arbors
	Cat. No. Size	Cat. No. Size
	31514 7/8"	31650 1/4"
	31518 1-1/8"	31660 7/16"
	31522 1-3/8"	31670 7/16"
	31528 1-3/4"	
	31532 2"	
	31540 2-1/2"	
	31548 3"	
	31558 3-5/8"	
	31566 4-1/8"	
	31572 4-1/2"	

Note: Set pilot drill point 1/8" beyond tooth points.
 Note: Read and follow safety instructions in power tool owner's manual.



31640

Large Size Hole Saw Kit

- Contains the sizes necessary to upgrade an Electrician's Hole Saw Kit into a Master Electrician's set.
- All components are packed in a metal carrying case.

Cat. No.	Set Contains	Weight (lbs.)
31645		6.60
	Hole Saws	Arbors
	Cat. No. Size	Cat. No. Size
	31548 3"	31670 7/16"
	31558 3-5/8"	
	31566 4-1/8"	
	31572 4-1/2"	

Note: Set pilot drill point 1/8" beyond tooth points.
 Note: Read and follow safety instructions in power tool owner's manual.

Electrician's Hole Saw Kit

- Contains the most popular sizes for basic electrical work.
- All components are packed in a rust-proof, molded plastic carrying case.

Cat. No.	Set Contains	Weight (lbs.)
31630		2.60
	Hole Saws	Arbors
	Cat. No. Size	Cat. No. Size
	31514 7/8"	31660 7/16"
	31518 1-1/8"	31670 7/16"
	31522 1-3/8"	
	31528 1-3/4"	
	31532 2"	
	31540 2-1/2"	

Note: Set pilot drill point 1/8" beyond tooth points.
 Note: Read and follow safety instructions in power tool owner's manual.

Journeyman's Hole Saw Kit

- The most frequently used sizes and an arbor extension for hard to reach spots.
- All components are packed in a rust-proof, molded plastic carrying case.

Cat. No.	Set Contains	Weight (lbs.)
31635		4.50
	Hole Saws	Arbors
	Cat. No. Size	Cat. No. Size
	31512 3/4"	31650 1/4"
	31514 7/8"	31660 7/16"
	31518 1-1/8"	31670 7/16"
	31522 1-3/8"	
	31524 1-1/2"	Arbor Extender
	31528 1-3/4"	Cat. No. Size
	31532 2"	31678 12"
	31536 2-1/4"	
	31540 2-1/2"	

Note: Set pilot drill point 1/8" beyond tooth points.
 Note: Read and follow safety instructions in power tool owner's manual.

All dimensions are in inches and (millimeters) unless otherwise specified.

▲WARNING: Always ensure that you and persons in the vicinity wear approved eye protection.

Hole Saws

Carbide Grit Hole Saws **GREAT WHITE®**

- Available in the most common sizes for recessed can lights.
- Carbide grit for smooth cuts and minimal tear out.
- Long-lasting carbide grit won't dull in abrasive materials.
- Grit design reduces the kick when starting a cut in plywood.
- Cuts through drywall, ceiling tile, lath/plaster, cement board, and wood.

Cat. No.	Saw Diameter	For Use with Arbor No.	Weight (lbs.)
31605	6-3/8" (161 mm)	31168, 31665, 31670	1.65
31607	6-5/8" (168 mm)	31168, 31665, 31670	1.65
31611	6-7/8" (174 mm)	31168, 31665, 31670	1.75

Note: Set pilot drill point 1/8" beyond tooth points.
 Note: Read and follow safety instructions in power tool owner's manual.



31605

Quick Cutter® Adjustable Hole Saw

- Hole saw blades adjust to cut holes from 2-1/2" to 7" in diameter.
- Carbide coated blades for longer blade life.
- Cuts holes in drywall and ceiling tile.
- Dust shield included.

Cat. No.	Range	Weight (lbs.)
53731	2-1/2" - 7" (64 mm - 177 mm)	1.00

Quick Cutter® is a registered trademark of Speare Tools.

NOTE: Read and follow safety instructions in power tool owner's manual.



53731

Ship-Auger Bits

Ship-Auger Bits with Screw Point

- Bits drill through nails, wood, vinyl, plastics, and heavy timber.
- Special bit steel with machine-ground flutes and polished edges for smooth, wobble-free boring.
- Feed-screw pilot draws bit into wood.
- Full length is heat-treated and tempered.
- Deep, open-throat design clears chips for faster, cleaner cuts.



53429

- Shanks are 7/16" hex to fit 1/2" and larger three-jaw chucks.
- Head and twist are ground to correct clearance for easy removal from hole.
- For heavy construction and repair work in mines, on docks and bridges, and for electrical work.

Cat. No.	Bit Size	Twist Length	Overall Length	Weight (lbs.)
53401	11/16"	4" (102 mm)	6" (152 mm)	.30
53402	3/4"	4" (102 mm)	6" (152 mm)	.40
53403	13/16"	4" (102 mm)	6" (152 mm)	.40
53404	7/8"	4" (102 mm)	6" (152 mm)	.50
53405	15/16"	4" (102 mm)	6" (152 mm)	.50
53406	1"	4" (102 mm)	6" (152 mm)	.50
53407	1-1/16"	4" (102 mm)	6" (152 mm)	.60
53408	1-1/8"	4" (102 mm)	6" (152 mm)	.80
53409	1-1/4"	4" (102 mm)	6" (152 mm)	1.00
53410	1-3/8"	4" (102 mm)	6" (152 mm)	.80
53411	1-1/2"	4" (102 mm)	6" (152 mm)	.90
53426	3/4"	4-3/4" (121 mm)	7-3/4" (197 mm)	.45
53428	7/8"	4-3/4" (121 mm)	7-3/4" (197 mm)	.60
53429	1"	4-3/4" (121 mm)	7-3/4" (197 mm)	.60
53430	1-1/8"	4-3/4" (121 mm)	7-3/4" (197 mm)	.80

Cat. No.	Bit Size	Twist Length	Overall Length	Weight (lbs.)
53431	1-1/4"	4-3/4" (121 mm)	7-3/4" (197 mm)	.90
53434	9/16"	15" (381 mm)	18" (457 mm)	.65
53435	5/8"	15" (381 mm)	18" (457 mm)	.80
53436	11/16"	15" (381 mm)	18" (457 mm)	.85
53437	3/4"	15" (381 mm)	18" (457 mm)	.95
53438	13/16"	15" (381 mm)	18" (457 mm)	1.05
53439	7/8"	15" (381 mm)	18" (457 mm)	1.20
53440	15/16"	15" (381 mm)	18" (457 mm)	1.50
53441	1"	15" (381 mm)	18" (457 mm)	1.70
53442	1-1/16"	15" (381 mm)	18" (457 mm)	1.95
53443	1-1/8"	15" (381 mm)	18" (457 mm)	1.80
53444	1-1/4"	15" (381 mm)	18" (457 mm)	2.20
53445	1-3/8"	15" (381 mm)	18" (457 mm)	2.80
53446	1-1/2"	15" (381 mm)	18" (457 mm)	3.45

All dimensions are in inches and (millimeters) unless otherwise specified.

⚠WARNING: Never use on or near live electrical circuits.

⚠WARNING: Always ensure that you and persons in the vicinity wear approved eye protection.

Tool Bags

Zipper Bag



5139



5139B



5139C

- Constructed of No. 10 canvas with heavy-duty brass zipper.
- Convenient storage for pliers, wrenches, screwdrivers, nut drivers, other tools, and spare parts.
- Constructed of Cordura® ballistic nylon, a high-performance fabric resistant to abrasions, tears, and scuffs (Cat. Nos. 5139B, 5139, 5139C).
- Heavy-duty nylon zipper. (Cat. Nos. 5139B, 5139).
- Features the desert stalker digitized camouflage pattern for maximum concealment (Cat. No. 5139C).
- Heavy-duty nylon stitching and zipper ensure durability and long life (Cat. Nos. 5139C).

Cat. No.	Material	Length	Height	Weight (lbs.)
5139	canvas	12-1/2" (318 mm)	7" (178 mm)	.19
5139B	Cordura® Ballistic Nylon	12-1/2" (318 mm)	7" (178 mm)	.24
5139C	Cordura® Camouflage	12-1/2" (318 mm)	7" (178 mm)	.14

Cordura® is a registered trademark of INVISTA for durable fabrics.

Zipper Bags – Canvas, 4-Pack

- Includes four assorted colors (olive, orange, royal-blue, and yellow) to organize and categorize important tools.
- Constructed of No. 10 canvas with heavy-duty brass zipper.
- Convenient storage for pliers, wrenches, screwdrivers, nut drivers, other tools and spare parts.
- Overall size: 12-1/2" (318 mm) long x 7" (178 mm) high.



5140

Cat. No.	Description	Weight (lbs.)
5140	4 zipper bags - canvas	.80

Padded Cordura® Zipper Bag

- Constructed of Cordura®, a high performance fabric resistant to abrasions, tears, and scuffs.
- Three-layer padding provides additional protection to contents.
- Heavy-duty nylon zipper.
- Overall size: 12-1/2" (318 mm) x 7" (178 mm).

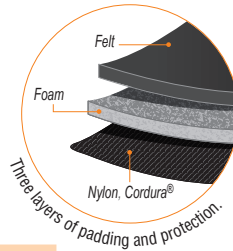

5139PAD

Cordura® is a registered trademark of INVISTA for durable fabrics.

Cat. No.	Material	Length	Height	Color	Weight (lbs.)
5139PAD	Cordura®	12-1/2" (318 mm)	7" (178 mm)	black	.28

Canvas Zipper Bags – Consumables

- Constructed of No. 8 canvas, with heavy-duty brass zipper.
- Convenient storage for wire nuts, connectors and other consumables.
- 3-1/2" wide bottom for stability when standing; easy access when open.
- Brass grommet for hanging or attaching to belt or clip.
- Overall size: 10" (254 mm) long x 8" (203 mm) tall x 3-1/2" (89 mm) wide.

Cat. No.	Material	Length	Height	Width	Color	Weight (lbs.)
5539RED	canvas	10" (254 mm)	8" (203 mm)	3- 1/2" (89 mm)	red	.25
5539BLU	canvas	10" (254 mm)	8" (203 mm)	3- 1/2" (89 mm)	blue	.25
5539YEL	canvas	10" (254 mm)	8" (203 mm)	3- 1/2" (89 mm)	yellow	.25
5539NAT	canvas	10" (254 mm)	8" (203 mm)	3- 1/2" (89 mm)	natural	.25
5539CPAK	canvas	see above	see above	see above	3-pack: red, blue, yellow	.75



5539BLU



Voice/Data/Video Kits

Coax Installer Starter Kit – F-Connectors

- Includes the tools needed to prepare and connect F-Connectors.
- Durable nylon tool pouch designed specifically for F-connector installation tools.
- Additional pocket holds a screwdriver or common AA battery flashlights.
- Pouch includes a closeable pocket that will hold up to 25 compression F-connectors.
- Tunnel-loop accommodates up to 2" belt.



Cat. No.	Set Contains	Weight (lbs.)
VDV012-811		1.44

Cat. No.	Description
63020	Multi-Cable Cutter
VDV110-802	Radial Cartridge Stripper - Coaxial Cable, 2-Level
VDV212-008	Compression Crimper - Compact, F-Connector
Kit Exclusive	5-Pocket Nylon Tool Pouch plus closeable consumables pocket

VDV012-811

LAN Installer Starter Kit – Modular

- Includes the tools needed to prepare, connect and test modular cables.
- Durable nylon tool pouch designed specifically for modular plug installation tools.
- Two additional pockets hold a screwdriver and common AA battery flashlights.
- Pouch includes a closeable pocket that will hold up to 25 RJ45 plugs.
- Tunnel-loop accommodates up to 2" belt.



Cat. No.	Set Contains	Weight (lbs.)
VDV026-812		1.5

Cat. No.	Description
2100-8	Stainless Steel Electrician's Scissors - Free-Fall
VDV226-011	Ratcheting Modular Cutter/Crimper/Stripper
VDV526-052	LAN Scout™ Junior Tester
98554	Fine Point Permanent Marker
Kit Exclusive	5-Pocket Nylon Tool Pouch plus closeable consumables pocket

VDV026-812

VDV026-812

LAN Installer Starter Kit – Punchdown

- Includes the tools needed to prepare and connect 66 type and 110 type punchdown terminal blocks.
- Durable nylon tool pouch designed specifically for punchdown installation tools.
- Two additional pockets hold a screwdriver and common AA battery flashlights.
- Tunnel-loop accommodates up to 2" belt.













Cat. No.	Set Contains	Weight (lbs.)
VDV027-813		.88



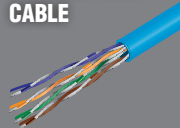







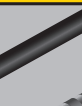

Cat. No.	Description
2100-8	Stainless Steel Electrician's Scissors - Free-Fall
VDV427-047	Punchdown Multi-Tool Chassis
VDV427-015	Punchdown Tool Blade - 110 type
VDV427-017	Punchdown Tool Blade - combination 66/110 cut type
98554	Fine Point Permanent Marker
Kit Exclusive	4-Pocket Nylon Tool Pouch

VDV027-813

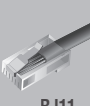

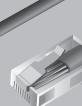



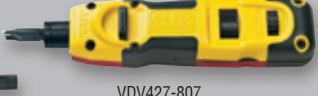

1 PREPARATION

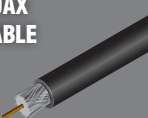
CABLE TYPE		CUT	STRIP
COAX CABLE 	RG-59	 63020  63028	 VDV100-801  VDV110-061  VDV110-802
	RG-6		
	RG-6 QUAD		
TWISTED PAIR CABLE 	CAT 3	 2100-7  2100-8	 VDV120-006
	CAT 5e		
	CAT 6		

2 CONNECTION

CABLE TYPE		CONNECTOR	TERMINATE
COAX CABLE 	RG-59	 F-Connector  BNC Connector  RCA Connector	 VDV211-063  VDV211-048
	RG-6		
	RG-6 QUAD		
TWISTED PAIR CABLE 	CAT 3	MODULAR PLUGS  RJ11  RJ22  RJ45 TERMINAL PATCH PANELS  	 VDV226-011  VDV427-807
	CAT 5e		
	CAT 6		

3 TESTING

CABLE TYPE		IDENTIFY / VERIFY
COAX CABLE 	RG-59	 VDV500-060  VDV526-054  VDV512-057  VDV512-058
	RG-6	
	RG-6 QUAD	
TWISTED PAIR CABLE 	CAT 3	 VDV501-809  VDV500-051  VDV526-052
	CAT 5e	
	CAT 6	



www.kleintools.com

Klein Tools, Inc. • 450 Bond Street • Lincolnshire • IL 60069-1418 • phone: 847-821-5500 • fax: 800-553-4876