

### DESCRIPTION

The MP9181 is a fully-integrated, high-efficiency, synchronous, step-down, switch mode converter. It offers a very compact solution that can achieve 3A continuous output current over a wide input supply range with excellent load and line regulation. This device operates with high efficiency over a wide output-current load range.

Constant-On-Time (COT) control mode provides fast transient response and eases loop stabilization.

Full protection features include SCP, OCP, UVP, and thermal shut down.

The MP9181 requires a minimal number of readily-available standard external components.

This device is available in a space-saving 2mmx3mm 12-pin QFN package.

### FEATURES

- Compatible with Intel Thunderbolt Specs
- Wide 4.5V to 20V Operating Input Range
- 3A Output Current
- +/-1%  $V_{FB}$  Voltage Tolerance
- Low  $R_{DS(ON)}$  Internal Power MOSFETs
- Proprietary Switching Loss Reduction Technique
- Up to 95% Peak Efficiency
- High Light Load Efficiency
- Soft Start-up/Shutdown
- Programmable Switching Frequency
- SCP, OCP, UVP Protection and Thermal Shutdown
- Hiccup Mode during OCP
- Power Good Indicator
- Ultra-small (2mmx3mm) QFN Package

### APPLICATIONS

- Networking/Communication Systems
- System I/O Power
- Distributed Power Systems

All MPS parts are lead-free and adhere to the RoHS directive. For MPS green status, please visit MPS website under Quality Assurance. "MPS" and "The Future of Analog IC Technology" are Registered Trademarks of Monolithic Power Systems, Inc.

### TYPICAL APPLICATION

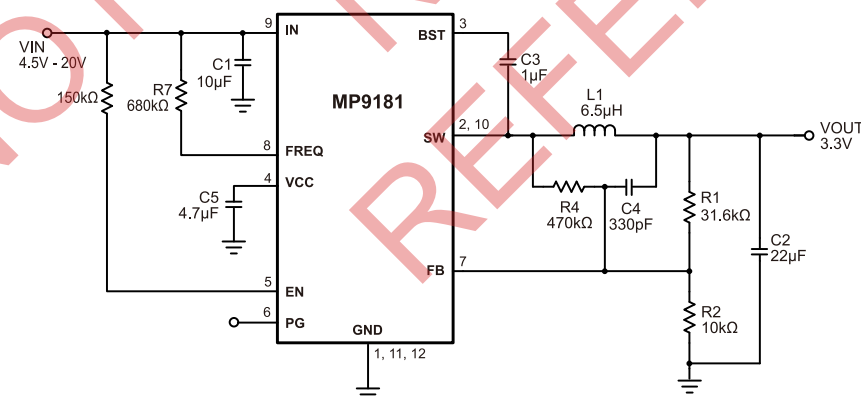

### Efficiency

$V_{IN}=12V$ ,  $V_{OUT}=3.3V$ ,  $L=6.5\mu H$

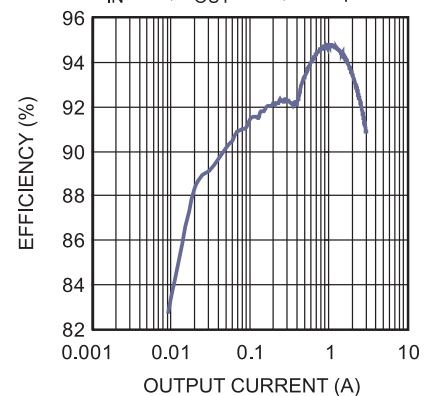

### ORDERING INFORMATION

Part Number	Package	Top Marking
MP9181DD	QFN12 (2x3mm)	AEH

\* For Tape & Reel, add suffix -Z (e.g. MP9181DD-Z).  
 For RoHS Compliant Packaging, add suffix -LF (e.g. MP9181DD-LF-Z)

### PACKAGE REFERENCE

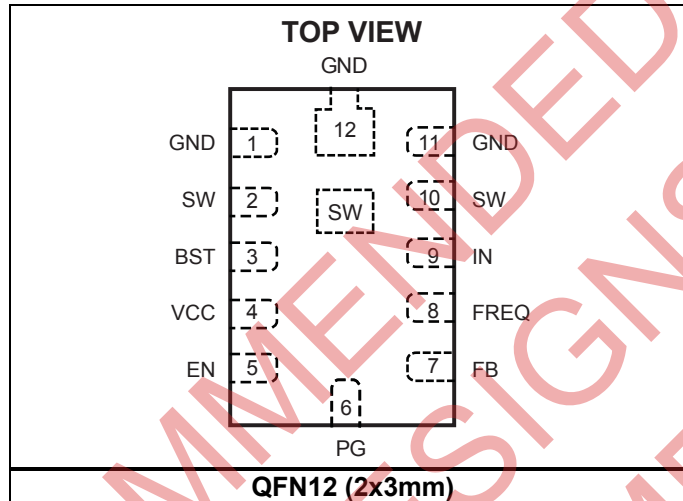

#### ABSOLUTE MAXIMUM RATINGS <sup>(1)</sup>

Supply Voltage $V_{IN}$ .....	22V
$V_{SW}$ ... -0.3V (-4V<10ns) to $V_{IN}$ +0.3V (24V<10ns)	
$V_{BST}$ .....	$V_{SW} + 6V$
$I_{VIN (RMS)}$ .....	3.5A
All Other Pins.....	-0.3V to +6V
Continuous Power Dissipation ( $T_A = 25^\circ C$ ) <sup>(2)</sup>	
QFN12 (2X3mm).....	1.8W
Junction Temperature .....	150°C
Lead Temperature .....	260°C
Storage Temperature.....	-65°C to +150°C

#### Recommended Operating Conditions <sup>(3)</sup>

Supply Voltage $V_{IN}$ .....	4.5V to 20V
Output Voltage $V_{OUT}$ .....	0.815V to 13V
Operating Junction Temp. ( $T_J$ ).....	-40°C to +125°C

<b>Thermal Resistance</b> <sup>(4)</sup>	$\theta_{JA}$	$\theta_{JC}$
QFN12 (2mmx3mm).....	70.....	15... °C/W

**Notes:**

- 1) Exceeding these ratings may damage the device. About the details of EN pin's ABS MAX rating, please refer to Page 12 Enable Control section.
- 2) The maximum allowable power dissipation is a function of the maximum junction temperature  $T_J$  (MAX), the junction-to-ambient thermal resistance  $\theta_{JA}$ , and the ambient temperature  $T_A$ . The maximum allowable continuous power dissipation at any ambient temperature is calculated by  $P_D$  (MAX) =  $(T_J$  (MAX)- $T_A$ )/ $\theta_{JA}$ . Exceeding the maximum allowable power dissipation will cause excessive die temperature, and the regulator will go into thermal shutdown. Internal thermal shutdown circuitry protects the device from permanent damage.
- 3) The device is not guaranteed to function outside of its operating conditions.
- 4) Measured on JESD51-7, 4-layer PCB.

## ELECTRICAL CHARACTERISTICS

$V_{IN} = 12V$ ,  $T_A = 25^\circ C$ , unless otherwise noted.

Parameters	Symbol	Condition	Min	Typ	Max	Units
Supply Current (Shutdown)	$I_{IN}$	$V_{EN} = 0V$		0		$\mu A$
Supply Current (Quiescent)	$I_{IN}$	$V_{EN} = 2V$ , $V_{FB} = 0.9V$		360		$\mu A$
HS Switch-on Resistance	$HS_{RDS-ON}$			120		m $\Omega$
LS Switch-on Resistance	$LS_{RDS-ON}$			50		m $\Omega$
Switch Leakage	$SW_{LKG}$	$V_{EN} = 0V$ , $V_{SW} = 0V$ or $12V$		0	10	$\mu A$
Current Limit <sup>(5)</sup>	$I_{LIMIT}$	After Soft-Start Time-out	4	5		A
One-Shot on Time	$T_{ON}$	$R_7 = 300k\Omega$ , $V_{OUT} = 1.2V$		250		ns
Minimum Off Time	$T_{OFF}$			130	150	ns
Fold-back Off Time	$T_{FB}$	$I_{LIM} = 1$		4.5		$\mu s$
OCP Hold-off Time	$T_{OC}$	$I_{LIM} = 1$		50		$\mu s$
Feedback Voltage	$V_{FB}$	$T_A = 25^\circ C$	807	815	823	mV
		$-40^\circ C \leq T_A \leq 85^\circ C$	803		827	mV
Feedback Current	$I_{FB}$	$V_{FB} = 850mV$		10	50	nA
Soft Start Time	$T_{SS}$			1		ms
EN Rising Threshold	$EN_{Vth-Hi}$		1.0	1.35	1.6	V
EN Threshold Hysteresis	$EN_{Vth-Hys}$			500		mV
EN Input Current	$I_{EN}$	$V_{EN} = 2V$		2		$\mu A$
		$V_{EN} = 0V$		0		
Power-good Rising Threshold	$PG_{Vth-Hi}$			0.9		$V_{FB}$
Power-good Falling Threshold	$PG_{Vth-Lo}$			0.85		$V_{FB}$
Power-good Delay	$PGTd$			0.5		ms
Power-good Sink Current Capability	$VPG$	Sink 4mA			0.4	V
Power-good Leakage Current	$IPG\_LEAK$	$VPG = 3.3V$			10	nA
VIN Under-voltage Lockout Threshold Rising	$INUV_{Vth\_rising}$		3.9	4.1	4.3	V
VIN Under-voltage Lockout Threshold Falling	$INUV_{Vth\_falling}$		3.4			V
VIN Under-voltage Lockout Threshold Hysteresis	$INUV_{Vth\_HYS}$			500		mV
Thermal Shutdown	$T_{SD}$			150		$^\circ C$
Thermal Shutdown Hysteresis	$T_{SD-HYS}$			25		$^\circ C$

**Note:**

5) Guaranteed by design and characterization.

## PIN FUNCTIONS

QFN12 (2x3mm) Pin #	Name	Description
1, 11, 12	GND	System Ground. These pins are the reference ground for the regulated output voltage, and require special consideration during PCB layout.
2, 10, exposed pad	SW	Switch output. Connect using wide PCB traces.
3	BST	Bootstrap. Requires a capacitor connected between SW and BST pins to form a floating supply across the high-side switch driver.
4	VCC	Internal Bias Supply. Decouple with a 4.7 $\mu$ F ceramic capacitor as close to the pin as possible.
5	EN	EN = 1 to enable the MP9181. For automatic start-up, connect EN pin to VIN with a pull-up resistor. See Page 13 for more details.
6	PG	Power-Good Output. The output of this pin is an open drain that goes high if the output voltage is higher than 90% of the nominal voltage. There is a 0.5ms delay between when FB $\geq$ 90% to when the PG pin goes high.
7	FB	Feedback. Set the output voltage when connected to the tap of an external resistor divider that is connected between output and GND.
8	FREQ	Frequency. Set during CCM operation. Connect a resistor R <sub>7</sub> to IN to set the switching frequency. Decouple with a 1nF capacitor.
9	IN	Supply Voltage. The MP9181 operates from a +4.5V to +20V input rail. C1 is needed to decouple the input rail. Use wide PCB traces and multiple vias to make the connection.

## TYPICAL PERFORMANCE CHARACTERISTICS

$V_{IN} = 12V$ ,  $V_{OUT} = 1.2V$ ,  $L = 2\mu H$ ,  $T_A = 25^\circ C$ , unless otherwise noted.

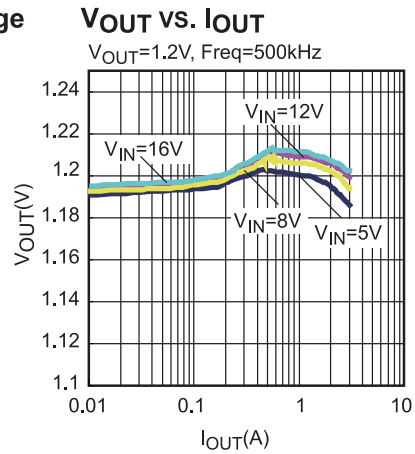
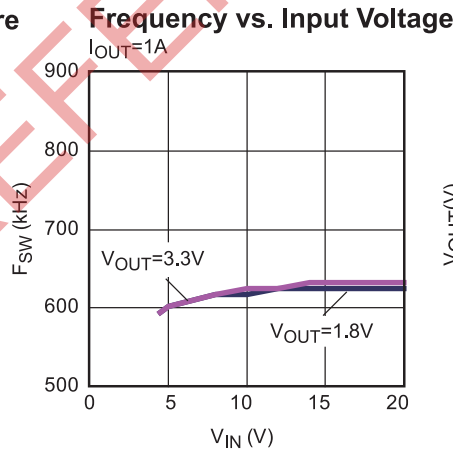
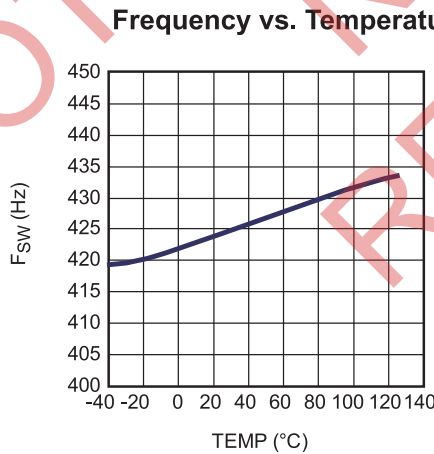
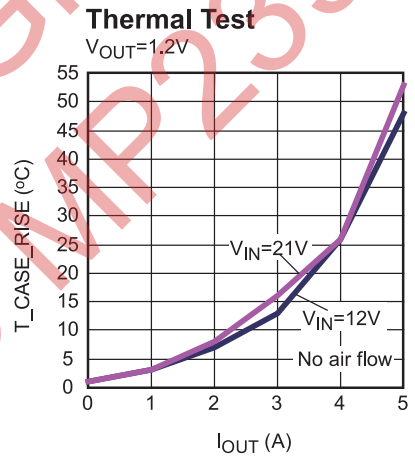
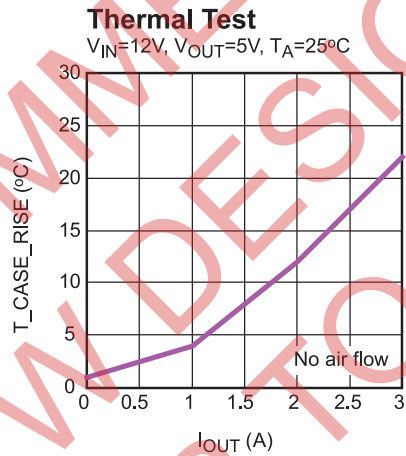
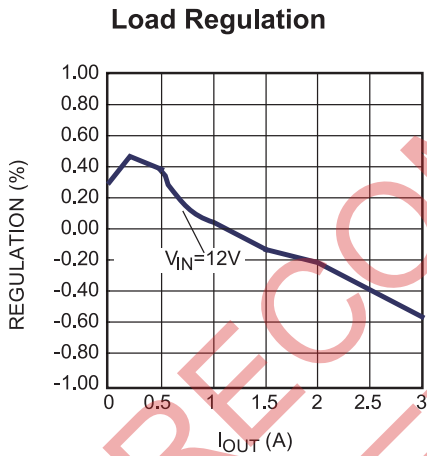
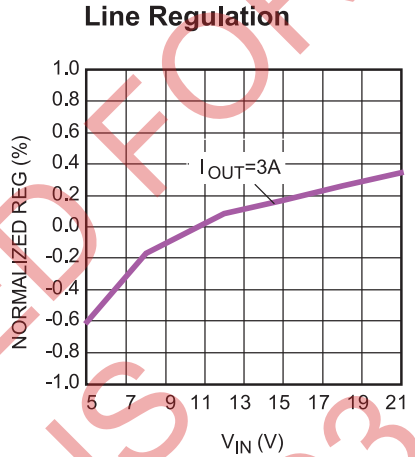
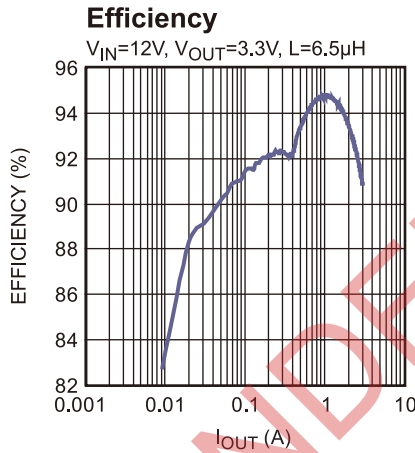
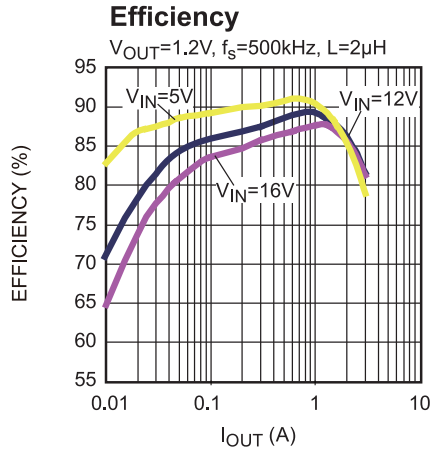

**TYPICAL PERFORMANCE CHARACTERISTICS (continued)**
 $V_{IN} = 12V$ ,  $V_{OUT} = 1.2V$ ,  $L = 2\mu H$ ,  $T_A = 25^\circ C$ , unless otherwise noted.

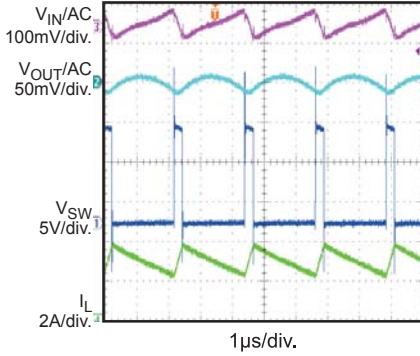
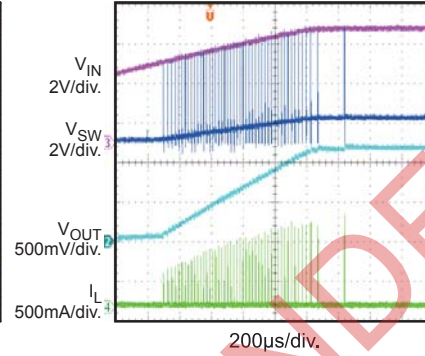
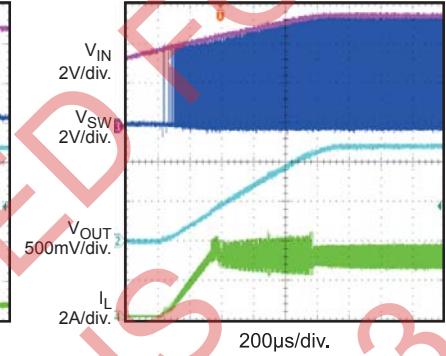
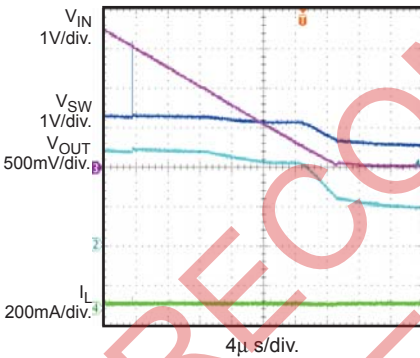
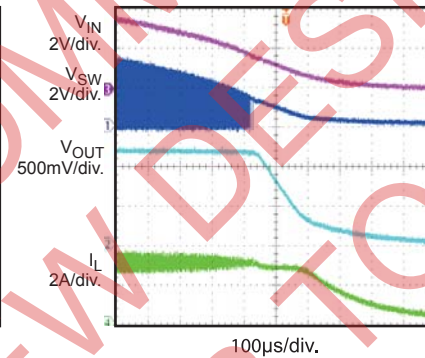
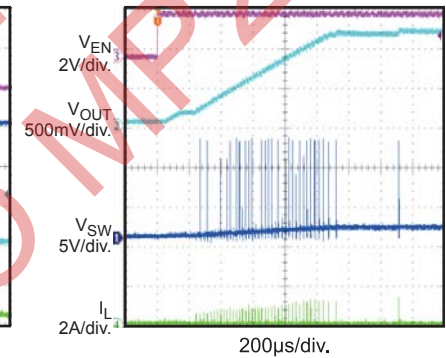
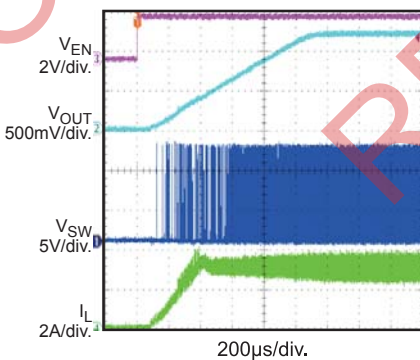
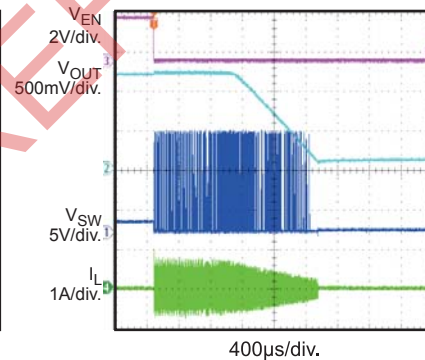
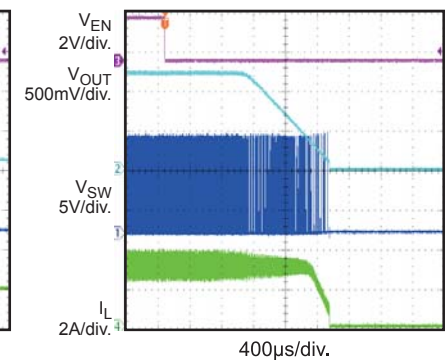
**Input/Output Voltage Ripple**  
 $I_{OUT} = 3A$ 

**Start up through IN**  
 $I_{OUT} = 0A$ 

**Start up through IN**  
 $I_{OUT} = 3A(CC-Load)$ 

**Power down through IN**  
 $I_{OUT} = 0A$ 

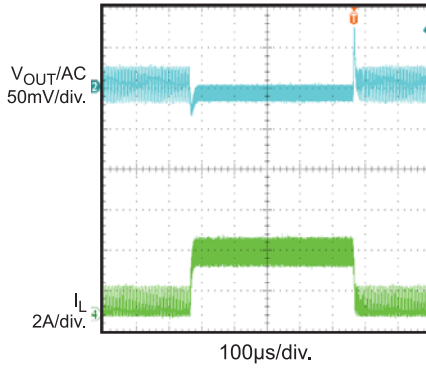
**Power down through IN**  
 $I_{OUT} = 3A(CC-Load)$ 

**Start up through EN**  
 $I_{OUT} = 0A$ 

**Start up through EN**  
 $I_{OUT} = 3A(CC-Load)$ 

**Power down through EN**  
 $I_{OUT} = 0A$ 

**Power down through EN**  
 $I_{OUT} = 3A(CC-Load)$ 

### TYPICAL PERFORMANCE CHARACTERISTICS (continued)

$V_{IN} = 12V$ ,  $V_{OUT} = 1.2V$ ,  $L = 2\mu H$ ,  $T_A = 25^\circ C$ , unless otherwise noted.

**Transient response**  
 $I_{OUT} = 0.3\sim 3A @ 2.5A/\mu s$



**Transient response**  
 $I_{OUT} = 0.3A\sim 3A @ 2.5A/\mu s$

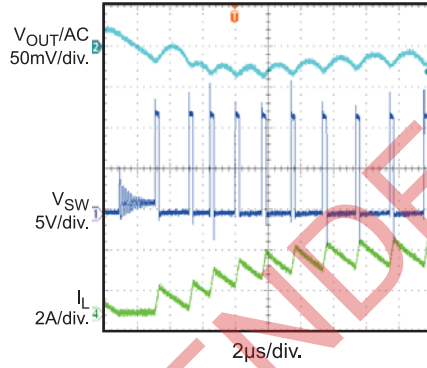

**Transient response**  
 $I_{OUT} = 3A\sim 0.3A @ 2.5A/\mu s$

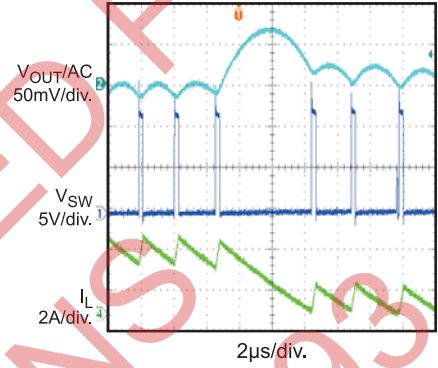

NOT RECOMMENDED FOR NEW DESIGNERS REFER TO MP2393

**BLOCK DIAGRAM**

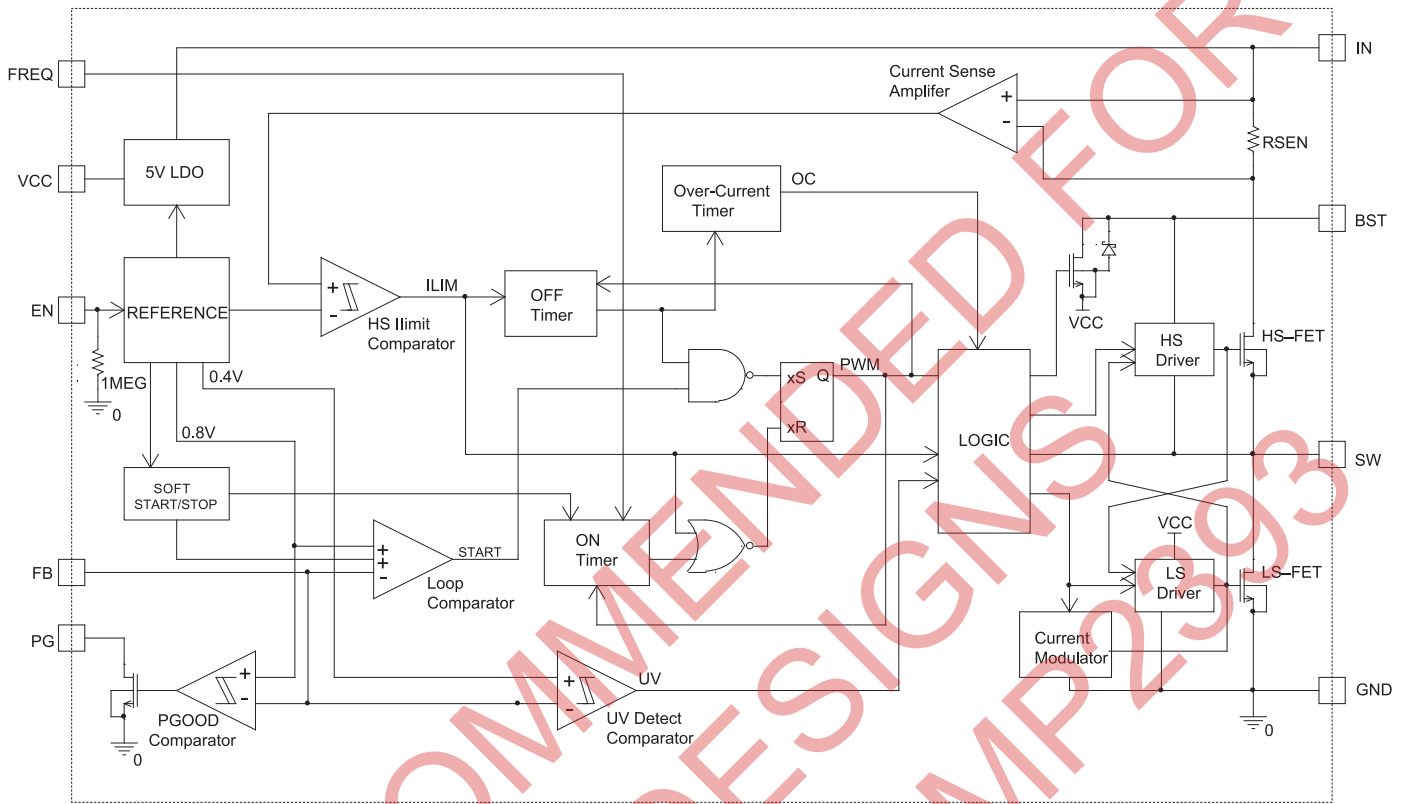

**Figure1—Functional Block Diagram**



## OPERATION

### PWM Operation

The MP9181 is a fully-integrated, synchronous, rectified, step-down switch converter. The device uses constant-on-time (COT) control to provide fast transient response and easy loop stabilization. At the beginning of each cycle, the high-side MOSFET (HS-FET) turns ON whenever the feedback voltage ( $V_{FB}$ ) is lower than the reference voltage ( $V_{REF}$ )—a low  $V_{FB}$  indicates insufficient output voltage. The input voltage and the frequency-set resistor determine the ON period as follows:

$$T_{ON}(ns) = \frac{9.3 \times R_7(k\Omega)}{V_{IN}(V) - 0.4} + 40ns \quad (1)$$

After the ON period elapses, the HS-FET enters the OFF state. By cycling HS-FET between the ON and OFF states, the converter regulates the output voltage. The integrated low-side MOSFET (LS-FET) turns on when the HS-FET is in its OFF state to minimize the conduction loss.

Shoot-through occurs when there is both HS-FET and LS-FET are turned on at the same time, causing a dead short between input and GND. Shoot-through dramatically reduces efficiency, and the MP9181 avoids this by internally generating a dead-time (DT) between when HS-FET is off and LS-FET is on, LS-FET is off and HS-FET is on. The device enters either heavy-load operation or light-load operation depending on the amplitude of the output current.

### Heavy-Load Operation

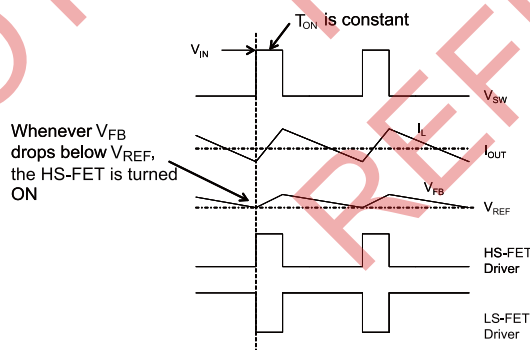

**Figure 2—Heavy Load Operation**

During heavy-load operation—when the output current is high—the MP9181 enters continuous-

conduction mode (CCM) where the HS-FET and LS-FET repeat the on/off operation described for PWM operation, the inductor current never goes to zero, and the switching frequency ( $F_{SW}$ ) is fairly constant. Figure 2 shows the timing diagram during this operation.

### Light-Load Operation

During light-load operation—when the output current is low—the MP9181 automatically reduces the switching frequency to maintain high efficiency, and the inductor current drops near zero. When the inductor current reaches zero, the LS-FET driver goes into tri-state (high Z). The current modulator controls the LS-FET and limits the inductor current to around -1mA as shown in Figure 3. Hence, the output capacitors discharge slowly to GND through LS-FET, R1, and R2. This operation greatly improves device efficiency when the output current is low.

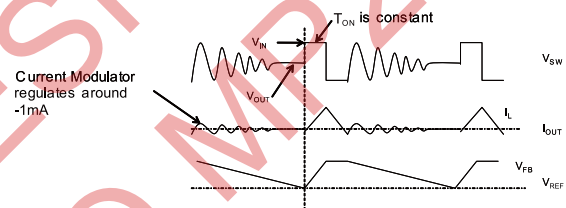
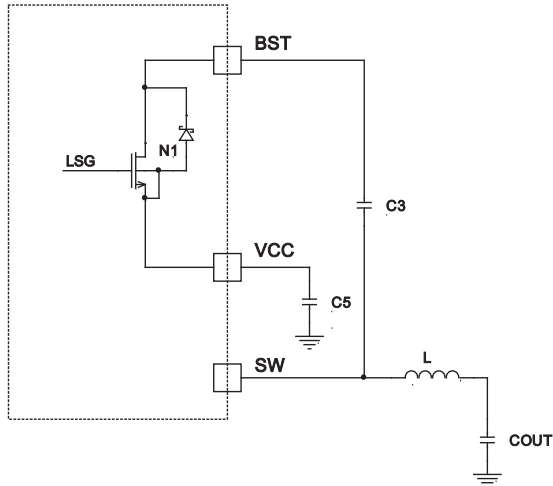

**Figure 3—Light Load Operation**

Light-load operation is also called skip mode because the HS-FET does not turn on as frequently as during heavy-load conditions. The frequency at which the HS-FET turns on is a function of the output current—as the output current increases, the time period that the current modulator regulates becomes shorter, and the HS-FET turns on more frequently. The switching frequency increases in turn. The output current reaches the critical level when the current modulator time is zero, and can be determined using the following equation:

$$I_{OUT} = \frac{(V_{IN} - V_{OUT}) \times V_{OUT}}{2 \times L \times F_{SW} \times V_{IN}} \quad (2)$$

The device reverts to PWM mode once the output current exceeds the critical level. After that, the switching frequency stays fairly constant over the output current range.

**Figure 4—**

### Floating Driver and Bootstrap Charging

The floating power MOSFET driver is powered by an external bootstrap capacitor. This floating driver has its own UVLO protection with a rising threshold of 2.2V and a hysteresis of 150mV. The bootstrap capacitor is charged from VCC through N1 (Fig. 4). N1 turns on when the LS-FET turns on and turns off when the LS-FET turns off.

### Switching Frequency

MP9181 uses constant-on-time (COT) control because there is no dedicated oscillator in the IC. The input voltage is feed-forwarded to the on-time one-shot timer through the resistor R7. The duty ratio is kept as  $V_{OUT}/V_{IN}$ , and the switching frequency is fairly constant over the input voltage range. The switching frequency can be determined with the following equation:

$$F_{SW} \text{ (kHz)} = \frac{10^6}{\frac{9.3 \times R_7 \text{ (k}\Omega)}{V_{IN} \text{ (V)} - 0.4} \times \frac{V_{IN} \text{ (V)}}{V_{OUT} \text{ (V)}} + T_{DELAY} \text{ (ns)}} \quad (3)$$

Where  $T_{DELAY}$  is the comparator delay, and equals approximately 40ns.

MP9181 is optimized to operate at high switching frequency with high efficiency. High switching frequency makes it possible to use small-sized LC filter components to save system PCB space.

### Jitter and FB Ramp Slope

Jitter occurs in both PWM and skip modes when noise in the  $V_{FB}$  ripple propagates a delay to the HS-FET driver, as shown in Figures 5 and 6. Jitter can affect system stability, with noise immunity proportional to the steepness of  $V_{FB}$ 's downward slope. However,  $V_{FB}$  ripple does not directly affect noise immunity.

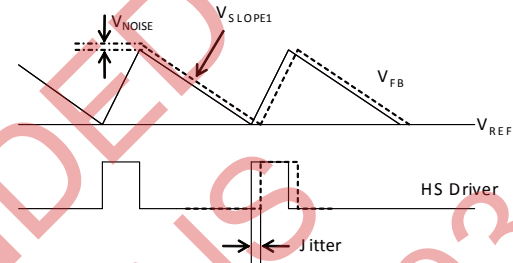
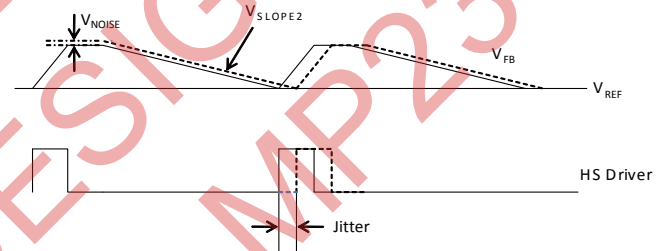
**Figure 5—Jitter in PWM Mode**

**Figure 6—Jitter in Skip Mode**

### Ramp with Large ESR Cap

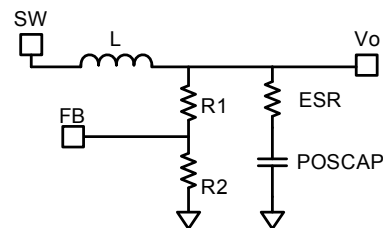
In the case of POSCAP or other types of capacitor with larger ESR is applied as output capacitor. The ESR ripple dominates the output ripple, and the slope on the FB is quite ESR related. Figure 7 shows an equivalent circuit in PWM mode with the HS-FET off and without an external ramp circuit. Turn to application information section for design steps with large ESR caps.

**Figure 7—Simplified Circuit in PWM Mode without External Ramp Compensation**

To realize the stability when no external ramp is used, usually the ESR value should be chosen as follow:

$$R_{ESR} \geq \frac{\frac{T_{SW}}{0.7 \times \pi} + \frac{T_{ON}}{2}}{C_{OUT}} \quad (4)$$

$T_{SW}$  is the switching period.

### Ramp with small ESR Cap

When the output capacitors are ceramic ones, the ESR ripple is not high enough to stabilize the system, and external ramp compensation is needed. Skip to application information section for design steps with small ESR caps

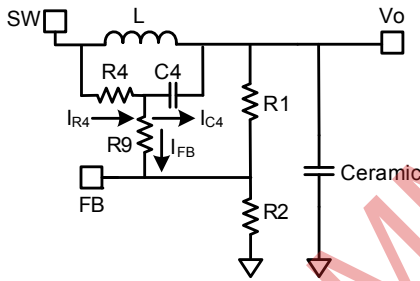

**Figure 8—Simplified Circuit in PWM Mode with External Ramp Compensation**

Figure 8 shows a simplified external ramp compensation ( $R_4$  and  $C_4$ ) for PWM mode, with HS-FET off. Chose  $R_1$ ,  $R_2$ ,  $R_9$  and  $C_4$  of the external ramp to meet the following condition:

$$\frac{1}{2\pi \times F_{SW} \times C_4} < \frac{1}{5} \times \left( \frac{R_1 \times R_2}{R_1 + R_2} + R_9 \right) \quad (5)$$

where:

$$I_{R4} = I_{C4} + I_{FB} \approx I_{C4} \quad (6)$$

And the magnitude of  $V_{FB}$  ( $V_{RAMP}$ ) on the  $V_{FB}$  can then be estimated as:

$$V_{RAMP} = \frac{V_{IN} - V_{OUT}}{R_4 \times C_4} \times T_{ON} \times \frac{R_1 // R_2}{R_1 // R_2 + R_9} \quad (7)$$

The downward slope of the  $V_{FB}$  ripple then follows

$$V_{SLOPE1} = \frac{-V_{RAMP}}{T_{off}} = \frac{-V_{OUT}}{R_4 \times C_4} \quad (8)$$

As can be seen from equation 8, if there is instability in PWM mode, we can reduce either  $R_4$  or  $C_4$ . If  $C_4$  can not be reduced further due to limitation from equation 5, then we can only reduce  $R_4$ . For a stable PWM operation, the  $V_{SLOPE1}$  should be design follow equation 9.

$$-V_{SLOPE1} \geq \frac{\frac{T_{SW}}{0.7 \times \pi} + \frac{T_{ON}}{2} - R_{ESR} C_{OUT}}{2 \times L \times C_{OUT}} V_{OUT} + \frac{I_o \times 10^{-3}}{T_{SW} - T_{on}} \quad (9)$$

$I_o$  is the load current.

In skip mode, the downward slope of the  $V_{FB}$  ripple is the same whether the external ramp is used or not. Figure9 shows the simplified circuit of the skip mode when both the HS-FET and LS-FET are off.

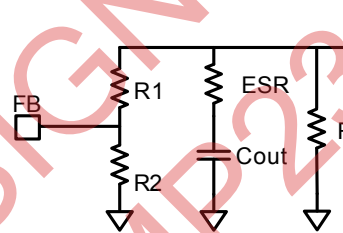

**Figure 9—Simplified Circuit in skip Mode**

The downward slope of the  $V_{FB}$  ripple in skip mode can be determined as follow:

$$V_{SLOPE2} = \frac{-V_{REF}}{((R_1 + R_2) // R_o) \times C_{OUT}} \quad (10)$$

where  $R_o$  is the equivalent load resistor.

As described in Figure 6,  $V_{SLOPE2}$  in the skip mode is lower than that is in the PWM mode, so it is reasonable that the jitter in the skip mode is larger. If one wants a system with less jitter during light load condition, the values of the  $V_{FB}$  resistors should not be too big, however, that will decrease the light load efficiency.

When using a large-ESR capacitor on, the output, add a ceramic capacitor with a value of 10uF or less to in parallel to minimize the effect of ESL.

## Enable Control

The MP9181 has a dedicated enable control pin (EN): pulling it high enables the IC, pulling it low disables it. Tie EN to VIN through a resistor for automatic start up. EN must be pulled low to disable the part.

The EN pin is clamped internally using a 6.7V series-Zener-diode as shown below. The EN input pin can be connected through a pullup resistor to any voltage connected to the VIN pin such that the pullup resistor limits the EN input current to less than 100 $\mu$ A.

For example, with 12V connected to Vin,  $R_{pullup} \geq (12V - 6.7V) \div 100\mu A = 53k\Omega$ .

If the EN pin is directly connected to a voltage source without any pullup resistor, then the amplitude of the voltage source should be limited below 6 to prevent from causing damage to the Zener diode.

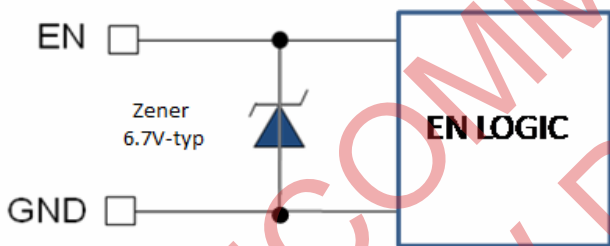

## Soft Start/Stop

MP9181 employs a soft start/stop (SS) mechanism to ensure smooth output during power up and power shut-down. The soft start circuit includes an internal soft start capacitor. When the EN pin goes high, the internal SS voltage slowly ramps up. The output voltage smoothly ramps up with the SS voltage. Once SS voltage rises above the VREF, it continues to ramp up while the PWM comparator only compares the VREF and the FB voltage. At this point, the soft start finishes and it enters steady state operation. The SS time is set about 1ms internally. When the EN pin goes low, an internal current source discharges the internal SS voltage. Once the SS voltage falls below the VREF, the PWM comparator will only compare the VREF to the SS voltage. The output voltage will decrease smoothly with the SS voltage until the voltage level zeros out.

## Power-Good (PG)

The PG pin is the open drain of a MOSFET that connects to V<sub>CC</sub> or some other voltage source through a resistor (ex. 100k). The MOSFET turns on with the application of an input voltage so that the PG pin is pulled to GND before SS is ready. After FB voltage reaches 90% of V<sub>REF</sub>, the PG pin is pulled high after a 0.5ms delay.

When the FB voltage drops to 85% of V<sub>REF</sub>, the PG pin will be pulled low.

## Over-Current Protection (OCP) and Short-Circuit Protection (SCP)

The MP9181 has cycle by cycle over-current limit control. The inductor current is monitored during the ON state to achieve OCP or SCP.

For MP9181 at OCP or SCP, it enters hiccup mode, that periodically restarts the part when the inductor current peak value exceeds the current limit and V<sub>FB</sub> drops below the under-voltage (UV) threshold. Typically, the UV threshold is 50% below the REF voltage. In OCP/SCP, the MP9181 will disable the output voltage power, discharge internal soft-start cap, and then automatically try to soft-start again. If the over-current circuit condition still holds after soft-start ends, it repeats this operation cycle until the over-current circuit condition disappears, and output rises back to regulation level.

## Under-voltage Protection (UVP)

The MP9181 monitors the output voltage through a resistor-divided feedback (FB) voltage to detect under voltage on the output. The UVP triggers when the FB voltage falls below 50% of the V<sub>REF</sub> (0.815V) Usually UVP accompanies a drop in the current limit and this results in SCP.

**UVLO Protection**

The MP9181 has under-voltage lock-out protection (UVLO). When the input voltage is higher than the UVLO rising threshold voltage, the MP9181 powers up. It shuts off when the input voltage is lower than the UVLO falling threshold voltage. This is non-latch protection.

**Thermal Shutdown**

The MP9181 employs thermal shutdown by internally monitoring the junction temperature of the IC. If the junction temperature exceeds the threshold value (typically 150°C), the converter shuts off. This is non-latch protection. There is about 25°C hysteresis. Once the junction temperature drops around 125°C, it initiates a soft start.

NOT RECOMMENDED FOR  
NEW DESIGNS  
REFER TO MP2393

## APPLICATION INFORMATION

### Setting the Output Voltage-Large ESR Caps

For applications that electrolytic capacitor or POS capacitor with a controlled output of ESR is set as output capacitors. The output voltage is set by feedback resistors R1 and R2. As Figure 10 shows.

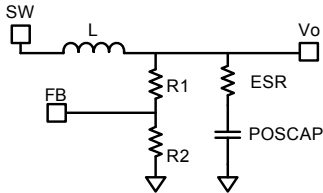

**Figure 10—Simplified Circuit of POS Capacitor**

First, choose a value for R2. R2 should be chosen reasonably, a small R2 will lead to considerable quiescent current loss while too large R2 makes the FB noise sensitive. It is recommended to choose a value within 5kΩ-50kΩ for R2, using a comparatively larger R2 when Vo is low, etc., 1.05V, and a smaller R2 when Vo is high. Then R1 is determined as follow with the output ripple considered:

$$R_1 = \frac{V_{OUT} - \frac{1}{2} \Delta V_{OUT} - V_{REF}}{V_{REF}} \cdot R_2 \quad (12)$$

$\Delta V_{OUT}$  is the output ripple determined by equation 21.

### Setting the Output Voltage-Small ESR Caps

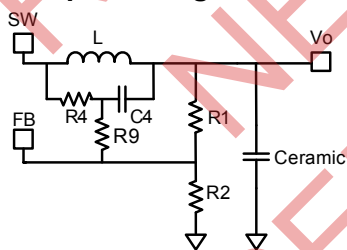

**Figure 11—Simplified Circuit of Ceramic Capacitor**

When low ESR ceramic capacitor is used in the output, an external voltage ramp should be added to FB through resistor R4 and capacitor C4. The output voltage is influenced by ramp voltage  $V_{RAMP}$  besides R divider as shown in Figure 11. The  $V_{RAMP}$  can be calculated as shown in equation 7. R2 should be chosen reasonably, a small R2 will lead to considerable quiescent

current loss while too large R2 makes the FB noise sensitive. It is recommended to choose a value within 5kΩ-50kΩ for R2, using a comparatively larger R2 when Vo is low, etc., 1.05V, and a smaller R2 when Vo is high. And the value of R1 then is determined as follow:

$$R_1 = \frac{V_{FB(AVG)}}{(V_{OUT} - V_{FB(AVG)})} \cdot \frac{R_2}{R_4 + R_9} \quad (13)$$

The  $V_{FB(AVG)}$  is the average value on the FB,  $V_{FB(AVG)}$  varies with the Vin, Vo, and load condition, etc., its value on the skip mode would be lower than that of the PWM mode, which means the load regulation is strictly related to the  $V_{FB(AVG)}$ . Also the line regulation is related to the  $V_{FB(AVG)}$ , if one wants to get a better load or line regulation, a lower Vramp is suggested once it meets Equation 9.

For PWM operation,  $V_{FB(AVG)}$  value can be deduced from equation 14.

$$V_{FB(AVG)} = V_{REF} + \frac{1}{2} V_{RAMP} \times \frac{R_1 // R_2}{R_1 // R_2 + R_9} \quad (14)$$

Usually, R9 is set to 0Ω, and it can also be set following equation 15 for a better noise immunity. It should also set to be 5 times smaller than R1//R2 to minimize its influence on Vramp.

$$R_9 = \frac{1}{2\pi \times C_4 \times 2F_{SW}} \quad (15)$$

Using equation 13 to calculate the output voltage can be complicated. To simplify the calculation of R1 in equation 13, a DC-blocking capacitor Cdc can be added to filter the DC influence from R4 and R9. Figure 12 shows a simplified circuit with external ramp compensation and a DC-blocking capacitor. With this capacitor, R1 can easily be obtained by using equation 16 for PWM mode operation.

$$R_1 = \frac{(V_{OUT} - V_{REF} - \frac{1}{2} V_{RAMP})}{V_{REF} + \frac{1}{2} V_{RAMP}} R_2 \quad (16)$$

C<sub>dc</sub> is suggested to be at least 10 times larger than C<sub>4</sub> for better DC blocking performance, and should also not larger than 0.47μF considering start up performance. In case one wants to use larger C<sub>dc</sub> for a better FB noise immunity, combined with reduced R<sub>1</sub> and R<sub>2</sub> to limit the C<sub>dc</sub> in a reasonable value without affecting the system start up. Be noted that even when the C<sub>dc</sub> is applied, the load and line regulation are still V<sub>ramp</sub> related.

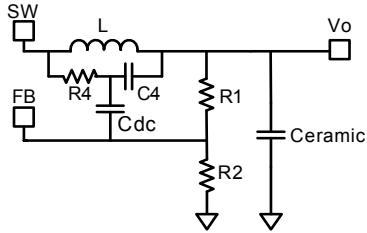

**Figure12—Simplified Circuit of Ceramic Capacitor with DC blocking capacitor**

### Input Capacitor

The input current to the step-down converter is discontinuous and therefore requires a capacitor to supply the AC current to the step-down converter while maintaining the DC input voltage. Ceramic capacitors are recommended for best performance and should be placed as close to the V<sub>IN</sub> pin as possible. Capacitors with X5R and X7R ceramic dielectrics are recommended because they are fairly stable with temperature fluctuations.

The capacitors must also have a ripple current rating greater than the maximum input ripple current of the converter. The input ripple current can be estimated as follows:

$$I_{CIN} = I_{OUT} \times \sqrt{\frac{V_{OUT}}{V_{IN}} \times \left(1 - \frac{V_{OUT}}{V_{IN}}\right)} \quad (17)$$

The worst-case condition occurs at V<sub>IN</sub> = 2V<sub>OUT</sub>, where:

$$I_{CIN} = \frac{I_{OUT}}{2} \quad (18)$$

For simplification, choose the input capacitor with an RMS current rating greater than half of the maximum load current.

The input capacitance value determines the input voltage ripple of the converter. If there is an input voltage ripple requirement in the system, choose the input capacitor that meets the specification.

The input voltage ripple can be estimated as follows:

$$\Delta V_{IN} = \frac{I_{OUT}}{F_{SW} \times C_{IN}} \times \frac{V_{OUT}}{V_{IN}} \times \left(1 - \frac{V_{OUT}}{V_{IN}}\right) \quad (19)$$

Under worst-case conditions where V<sub>IN</sub> = 2V<sub>OUT</sub>:

$$\Delta V_{IN} = \frac{1}{4} \times \frac{I_{OUT}}{F_{SW} \times C_{IN}} \quad (20)$$

### Output Capacitor

The output capacitor is required to maintain the DC output voltage. Ceramic or POSCAP capacitors are recommended. The output voltage ripple can be estimated as:

$$\Delta V_{OUT} = \frac{V_{OUT}}{F_{SW} \times L} \times \left(1 - \frac{V_{OUT}}{V_{IN}}\right) \times \left(R_{ESR} + \frac{1}{8 \times F_{SW} \times C_{OUT}}\right) \quad (21)$$

In the case of ceramic capacitors, the impedance at the switching frequency is dominated by the capacitance. The output voltage ripple is mainly caused by the capacitance. For simplification, the output voltage ripple can be estimated as:

$$\Delta V_{OUT} = \frac{V_{OUT}}{8 \times F_{SW}^2 \times L \times C_{OUT}} \times \left(1 - \frac{V_{OUT}}{V_{IN}}\right) \quad (22)$$

The output voltage ripple caused by ESR is very small. Therefore, an external ramp is needed to stabilize the system. The external ramp can be generated through resistor R<sub>4</sub> and capacitor C<sub>4</sub> following equation 5, 8 and 9.

In the case of POSCAP capacitors, the ESR dominates the impedance at the switching frequency. The ramp voltage generated from the ESR is high enough to stabilize the system. Therefore, an external ramp is not needed. A minimum ESR value around 12mΩ is required to ensure stable operation of the converter. For simplification, the output ripple can be approximated as:

$$\Delta V_{OUT} = \frac{V_{OUT}}{F_{SW} \times L} \times \left(1 - \frac{V_{OUT}}{V_{IN}}\right) \times R_{ESR} \quad (23)$$

The application design must also consider the maximum output capacitor value. If the output capacitor value is too high, the output voltage can't reach the designated value during the soft-start time, and then the device will fail to regulate. The maximum output capacitor value  $C_{O\_MAX}$  can be approximately by:

$$C_{O\_MAX} = (I_{LIM\_AVG} - I_{OUT}) \times T_{SS} / V_{OUT} \quad (24)$$

Where,  $I_{LIM\_AVG}$  is the average start-up current during soft-start period.  $T_{SS}$  is the soft-start time.

### Inductor

The inductor is necessary to supply constant current to the output load while being driven by the switched input voltage. A larger-value inductor will result in less ripple current that will result in lower output ripple voltage. However, a larger-value inductor will have a larger physical footprint, higher series resistance, and/or lower saturation current. A good rule for determining the inductance value is to design the peak-to-peak ripple current in the inductor to be in the range of 30% to 40% of the maximum output current, and that the peak inductor current is below the maximum switch current limit. The inductance value can be calculated by:

$$L = \frac{V_{OUT}}{F_{SW} \times \Delta I_L} \times \left(1 - \frac{V_{OUT}}{V_{IN}}\right) \quad (25)$$

Where  $\Delta I_L$  is the peak-to-peak inductor ripple current.

The inductor should not saturate under the maximum inductor peak current, where the peak inductor current can be calculated by:

$$I_{LP} = I_{OUT} + \frac{V_{OUT}}{2F_{SW} \times L} \times \left(1 - \frac{V_{OUT}}{V_{IN}}\right) \quad (26)$$

### Recommend Design Example

Some design examples and recommended maximum output capacitor value with typical outputs are provided below when the ceramic capacitors is applied:

**Table 2—1.2V  $V_{OUT}$  (L = 2 $\mu$ H)**

$V_{IN}$ (V)	$V_{OUT}$ (V)	C1	R7 ( $\Omega$ )	R4 ( $\Omega$ )	C4 (F)	R1 ( $\Omega$ )	R2 ( $\Omega$ )	$F_{SW}$ (Hz)
12	1.2	10 $\mu$ F*1	300k	499k	220p	12.1k	24.3k	450k
5	1.2	10 $\mu$ F*1	300k	390k	220p	12.1k	24.3k	440k

**Table 3—1.8V  $V_{OUT}$  (L = 2 $\mu$ H)**

$V_{IN}$ (V)	$V_{OUT}$ (V)	C1	R7 ( $\Omega$ )	R4 ( $\Omega$ )	C4 (F)	R1 ( $\Omega$ )	R2 ( $\Omega$ )	$F_{SW}$ (Hz)
12	1.8	10 $\mu$ F*1	402k	499k	220p	30k	24.3k	480k
5	1.8	10 $\mu$ F*1	402k	390k	220p	30k	24.3k	460k

**Table 4—2.5V  $V_{OUT}$  (L = 4.2 $\mu$ H)**

$V_{IN}$ (V)	$V_{OUT}$ (V)	C1	R7 ( $\Omega$ )	R4 ( $\Omega$ )	C4 (F)	R1 ( $\Omega$ )	R2 ( $\Omega$ )	$F_{SW}$ (Hz)
12	2.5	10 $\mu$ F*1	500k	453k	390p	21.5k	10k	500k
5	2.5	10 $\mu$ F*1	500k	453k	390p	21.5k	10k	500k

**Table 5—3.3V  $V_{OUT}$  (L = 6.5 $\mu$ H)**

$V_{IN}$ (V)	$V_{OUT}$ (V)	C1	R7 ( $\Omega$ )	R4 ( $\Omega$ )	C4 (F)	R1 ( $\Omega$ )	R2 ( $\Omega$ )	$F_{SW}$ (Hz)
12	3.3	10 $\mu$ F*1	680k	470k	330p	31.6k	10k	500k
5	3.3	10 $\mu$ F*1	680k	470k	330p	31.6k	10k	500k

**Table 6—5V  $V_{OUT}$  (L = 8.8 $\mu$ H)**

$V_{IN}$ (V)	$V_{OUT}$ (V)	C1	R7 ( $\Omega$ )	R4 ( $\Omega$ )	C4 (F)	R1 ( $\Omega$ )	R2 ( $\Omega$ )	$F_{SW}$ (Hz)
12	5	10 $\mu$ F*1	1M	750k	330p	53.6k	10k	500k

**Table 7—Recommended maximum output capacitor value ( $F_{SW}$ =500 kHz)**

**Recommended Conditions:  $V_{IN}$ =12V,  $I_{OUT}$ =3A**

$V_{OUT}$ (V)	1.2	1.8	2.5	3.3	5
$C_{O\_MAX}$ ( $\mu$ F)	680	570	390	330	220

The detailed application schematic is shown in Figure 13 when large ESR caps are used, and Figure 14 and Figure 15 when low ESR caps are applied. The typical performance and circuit waveforms have been shown in the Typical Performance Characteristics section. For more possible applications of this device, please refer to related Evaluation Board Data Sheets.



## TYPICAL APPLICATION SCHEMATIC

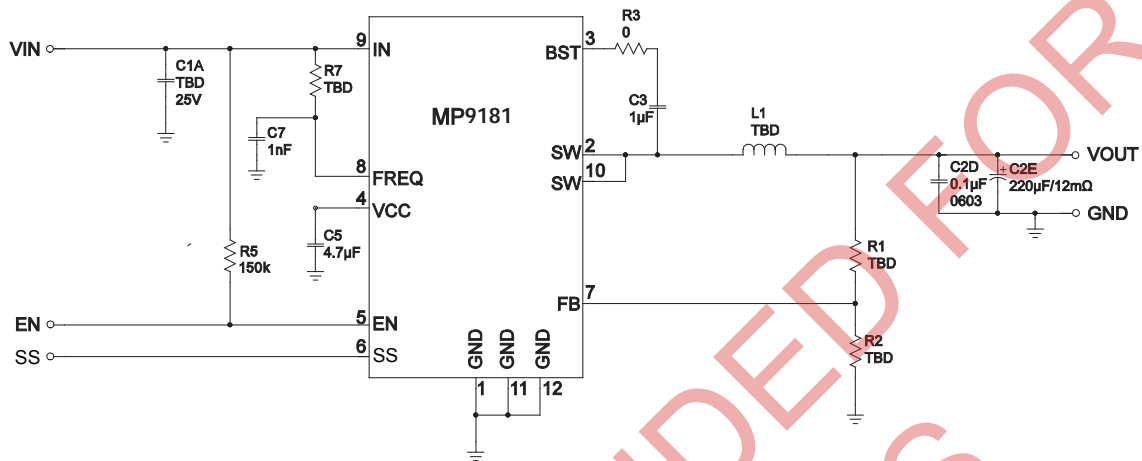

Figure 13—Typical Application Schematic with No External Ramp

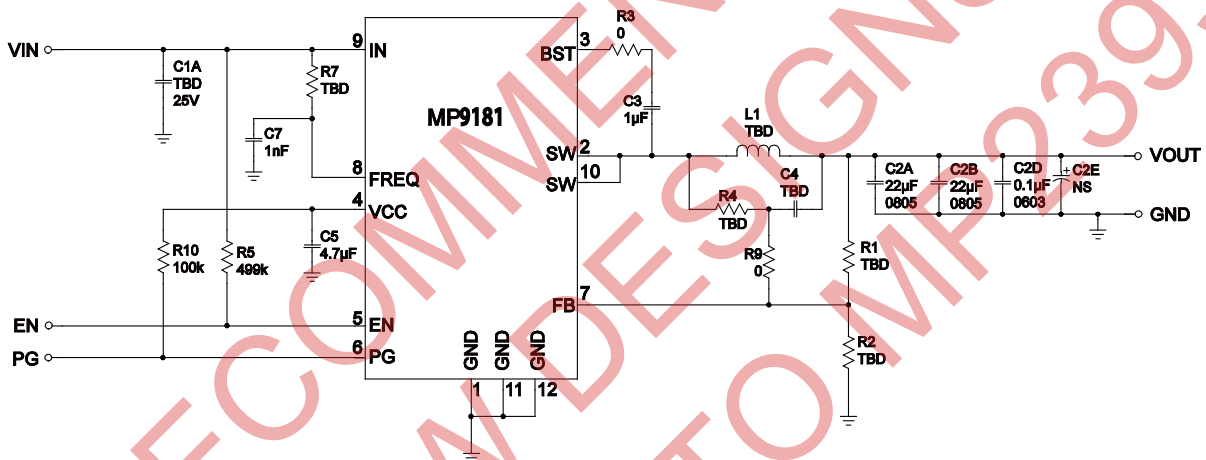

Figure 14—Typical Application Schematic with Low ESR Ceramic Capacitor

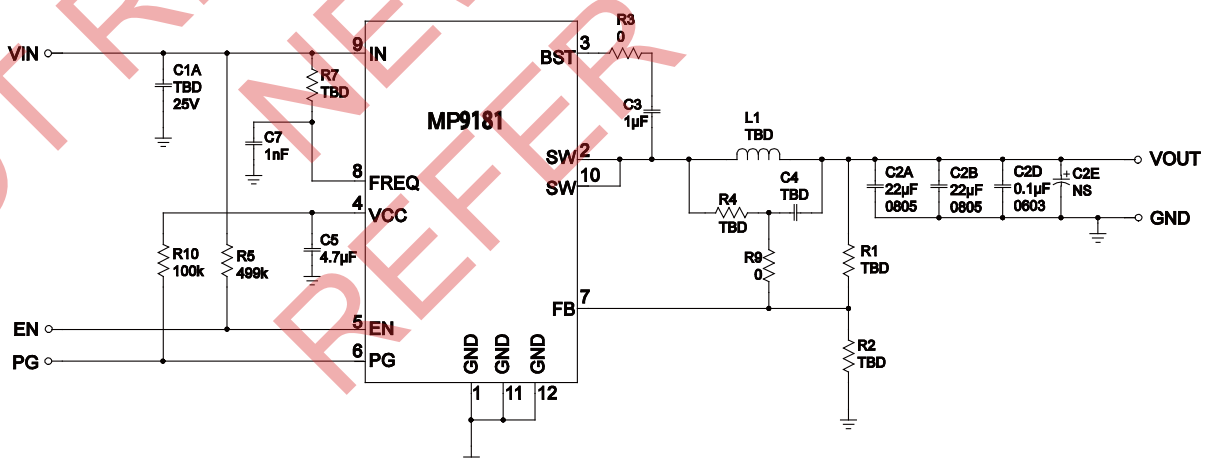

Figure 15—Typical Application Schematic with Low ESR Ceramic Capacitor and DC Blocking Capacitor

## LAYOUT RECOMMENDATION

- 1) The high current paths (GND, IN, and SW) should be placed very close to the device with short, wide, and direct traces.
- 2) Put the input capacitors as close to the IN and GND pins as possible.
- 3) Put the decoupling capacitor as close to the  $V_{CC}$  and GND pins as possible.
- 4) Keep the switching node SW short and away from the feedback network.
- 5) The external feedback resistors should be placed next to the FB pin. Make sure that there is no via on the FB trace.
- 6) Keep the BST voltage path (BST, C3, and SW) as short as possible.
- 7) Four-layer layout is recommended to achieve better thermal performance.

NOT RECOMMENDED FOR NEW DESIGNS REFER TO MP2393

# PACKAGE INFORMATION

## QFN12 (2x3mm)

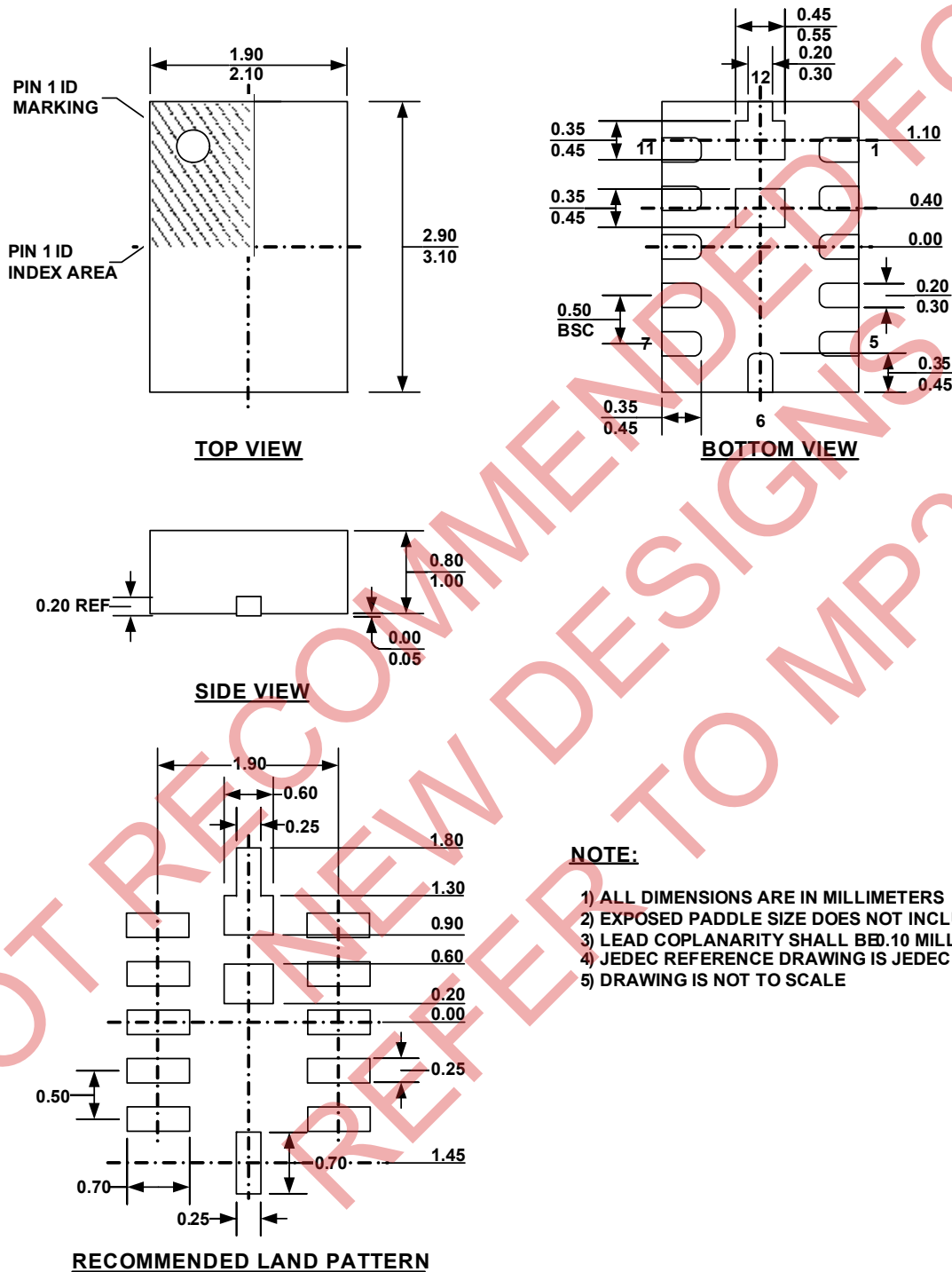

**NOTICE:** The information in this document is subject to change without notice. Users should warrant and guarantee that third party Intellectual Property rights are not infringed upon when integrating MPS products into any application. MPS will not assume any legal responsibility for any said applications.