

## DESCRIPTION

The MP2166 is an internally compensated, dual, PWM, synchronous, step-down regulator that operates from a 2.7V to 6V input and generates an output voltage as low as 0.6V. The MP2166 can be configured as a 2A/2A or 3A/1A output current regulator and is ideal for powering portable equipment that runs on a single-cell lithium-ion (Li+) battery due to a low 60 $\mu$ A quiescent current.

The MP2166 integrates dual, 55m $\Omega$ , high-side switches and 20m $\Omega$  synchronous rectifiers for high efficiency without an external Schottky diode. The MP2166 has peak-current-mode control and internal compensation and is capable of low dropout configurations. Both channels can operate at 100% duty cycle.

Full protection features include cycle-by-cycle current limit and thermal shutdown.

The MP2166 requires a minimum number of readily available, standard, external components and is available in QFN-18 (2mmx3mm) and QFN-18 (2.5mmx3.5mm) packages.

## FEATURES

- 2.7V to 6V Operating Input Range
- 2A/2A or 3A/1A Continuous Current
- 55m $\Omega$ /20m $\Omega$  R<sub>DS(ON)</sub>
- Programmed Frequency up to 3MHz
- External Sync Clock Up to 3MHz
- 180° Phase Shifted Operation
- PG Indicators
- External SS and Track
- Adjustable Advanced Asynchronous Mode (AAM) or Forced Continuous Conduction Mode (CCM)
- Peak Efficiency >90%
- Output Adjustable from 0.6V to VIN
- 100% Duty Cycle Operation
- 60 $\mu$ A Quiescent Current
- Cycle-by-Cycle Over-Current Protection (OCP)
- Short-Circuit Protection (SCP) with Hiccup Mode and Valley Current Detection
- Thermal Shutdown
- Available in QFN-18 (2mmx3mm) and QFN-18 (2.5mmx3.5mm) Packages

## APPLICATIONS

- Small/Handheld Devices
- DVD Drivers
- Smartphones and Feature Phones
- Battery-Powered Devices
- Portable Instruments

All MPS parts are lead-free, halogen-free, and adhere to the RoHS directive. For MPS green status, please visit MPS website under Quality Assurance. "MPS" and "The Future of Analog IC Technology" are registered trademarks of Monolithic Power Systems, Inc.

### TYPICAL APPLICATION

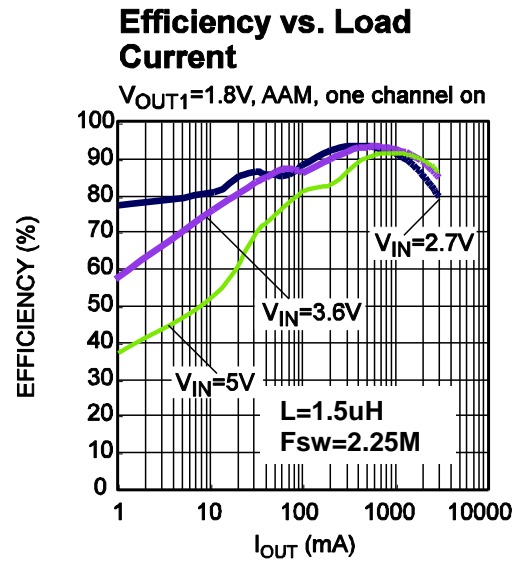
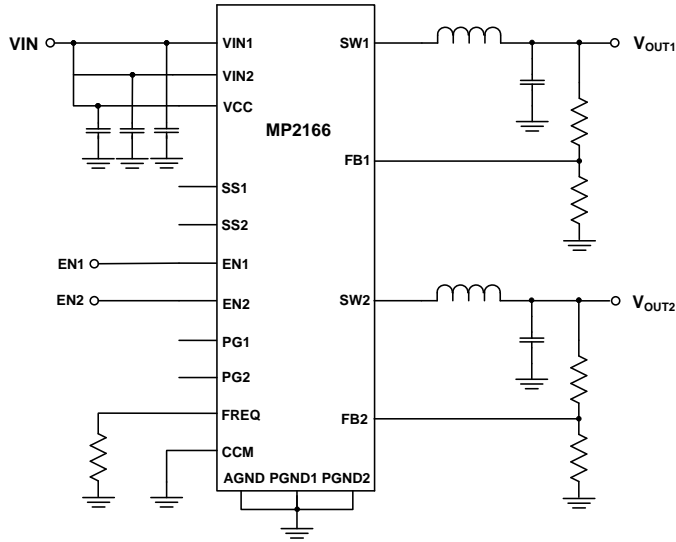

**ORDERING INFORMATION**

Part Number*	Package	Top Marking
MP2166GD	QFN-18 (2mmx3mm)	See below
MP2166GRH	QFN-18 (2.5mmx3.5mm)	

\* For Tape & Reel, add suffix -Z (e.g. MP2166GD-Z)

**TOP MARKING (MP2166GD)**

—  
**AQF**

**YWW**

**LLL**

AQF: Product code of MP2166GD

Y: Year code

WW: Week code

LLL: Lot number

**TOP MARKING (MP2166GRH)**

—  
**AVP**

**YWW**

**LLL**

AVP: Product code of MP2166GRH

Y: Year code

WW: Week code

LLL: Lot number

## PACKAGE REFERENCE

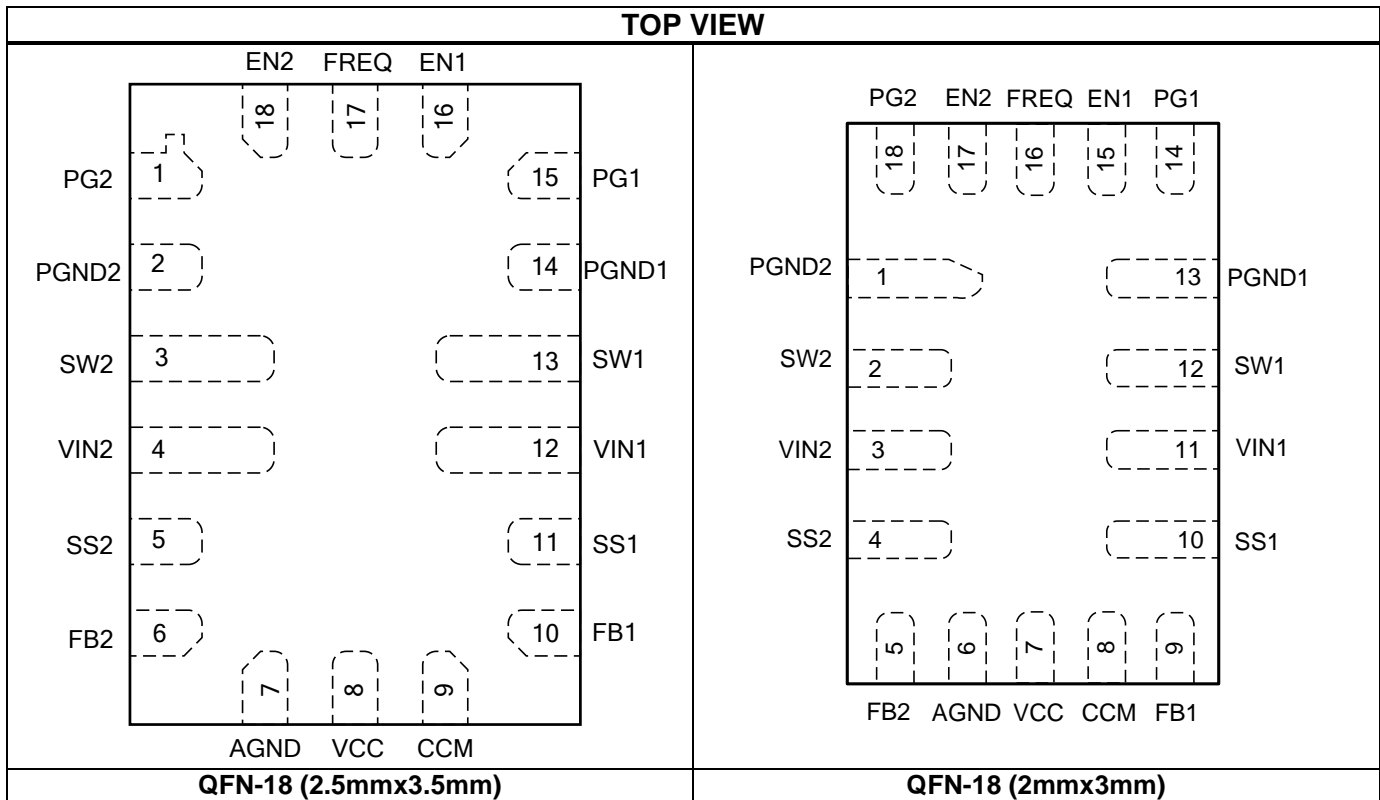

### Absolute Maximum Ratings <sup>(1)</sup>

Supply voltage ( $V_{IN}$ ) .....	6.5V
$V_{SW}$ .....	-0.3V to $V_{IN} + 0.3V$
All other pins .....	-0.3V to +6.5V
Junction temperature .....	150°C
Lead temperature .....	260°C
Continuous power dissipation ( $T_A = +25^\circ C$ ) <sup>(2)</sup>	
QFN-18 (2mmx3mm) .....	1.78W
QFN-18 (2.5mmx3.5mm) .....	2.5W

### Recommended Operating Conditions

Supply voltage ( $V_{IN}$ ) .....	2.7V to 6V
Output voltage ( $V_{OUT}$ ) .....	0.6V to 5.5V
Operating junction temp. ....	-40°C to +125°C

### Thermal Resistance <sup>(3)</sup>    $\theta_{JA}$    $\theta_{JC}$

QFN-18 (2mmx3mm) .....	70	15	°C/W
QFN-18 (2.5mmx3.5mm) .....	50	12	°C/W

#### NOTES:

- 1) Exceeding these ratings may damage the device.
- 2) The maximum allowable power dissipation is a function of the maximum junction temperature  $T_J$  (MAX), the junction-to-ambient thermal resistance  $\theta_{JA}$ , and the ambient temperature  $T_A$ . The maximum allowable continuous power dissipation at any ambient temperature is calculated by  $P_D$  (MAX) =  $(T_J$  (MAX) -  $T_A$ ) /  $\theta_{JA}$ . Exceeding the maximum allowable power dissipation produces an excessive die temperature, causing the regulator to go into thermal shutdown. Internal thermal shutdown circuitry protects the device from permanent damage.
- 3) Measured on JESD51-7, 4-layer PCB.

## ELECTRICAL CHARACTERISTICS

$V_{IN} = 5V$ ,  $T_J = -40^{\circ}C$  to  $+125^{\circ}C$ <sup>(4)</sup>, unless otherwise noted. Typical values are at  $T_J = +25^{\circ}C$ .

Parameters	Symbol	Condition	Min	Typ	Max	Units
Supply current (quiescent)	$I_Q$	$V_{IN} = 5V$ , $V_{EN} = 2V$ , $V_{FB} = 0.65V$ , no switching		60	80	$\mu A$
Shutdown current	$I_{SHDN}$	$V_{EN} = 0V$ , CCM=GND, $T_J = +25^{\circ}C$		0	0.2	$\mu A$
		$V_{EN} = 0V$ , CCM=GND $T_J = -40^{\circ}C$ to $+85^{\circ}C$ <sup>(5)</sup>		0	1.5	$\mu A$
		$V_{EN} = 0V$ , CCM=GND $T_J = +85^{\circ}C$ to $+125^{\circ}C$				5
VIN under-voltage lockout threshold	$IN_{UVLO}$	Rising edge		2.4	2.55	V
VIN under-voltage lockout hysteresis	$IN_{UVLO\_HYS}$			230		mV
Regulated FB voltage	$V_{FB}$	$T_J = +25^{\circ}C$	0.593	0.600	0.607	V
		$T_J = -40^{\circ}C$ to $+125^{\circ}C$	0.588	0.600	0.612	V
FB input current	$I_{FB}$	$V_{FB} = 0.65V$		0	50	nA
EN high threshold	$V_{EN\_H}$		1.6			V
EN low threshold	$V_{EN\_L}$				0.4	V
EN input current	$I_{EN}$	$V_{EN} = 2V$		0	0.1	$\mu A$
		$V_{EN} = 0V$		0	0.1	
HS switch on resistance	$R_{DSON\_P}$	$V_{IN} = 5V$		55	90	m $\Omega$
LS switch on resistance	$R_{DSON\_N}$	$V_{IN} = 5V$		20	45	m $\Omega$
SW leakage current	$I_{SW\_LK}$	$V_{EN} = 0V$ , $V_{IN} = 6V$ , $V_{SW} = 0V$ and $6V$ , $T_J = 25^{\circ}C$	-1	0	1	$\mu A$
HS switch current limit <sup>(5)</sup>	$I_{HS\_LIMIT}$	Sourcing	3.4	4.5	5.6	A
LS valley current limit <sup>(5)</sup>	$I_{VALLEY}$			3.9		A
LS switch current limit	$I_{LS\_LIMIT}$	Sinking, CCM	1			A
Oscillator frequency accuracy	$f_{SW}$	$R_{FREQ} = 665k$	298	350	402	kHz
		$R_{FREQ} = 200k$	850	1000	1150	kHz
		$R_{FREQ} = 51k$	2700	3000	3300	kHz
Sync frequency range	$f_{SYNC}$		0.35		3	MHz
Phase shift				180		degree
Minimum on time <sup>(5)</sup>	$T_{ON\_MIN}$			55		ns
Minimum off time <sup>(5)</sup>	$T_{OFF\_MIN}$			50		ns
Maximum duty cycle	$D_{MAX}$			100		%
Thermal shutdown threshold <sup>(5)</sup>	$T_D$			175		$^{\circ}C$
Thermal shutdown hysteresis <sup>(5)</sup>	$T_{D\_HYS}$			40		$^{\circ}C$
Soft-start charging current	$I_{SS}$	$V_{SS} = 0V$	2	3.2	5	$\mu A$
Power good rising threshold	$PGOOD_{Vth-Hi}$		0.85	0.9	0.95	$V_{FB}$
Power good falling threshold	$PGOOD_{Vth-Lo}$		0.77	0.82	0.87	$V_{FB}$
Power good rising delay	$T_{PGOOD\_R}$			30		$\mu s$
Power good falling delay	$T_{PGOOD\_F}$			40		$\mu s$
CCM on threshold			1.6			V
CCM off threshold					0.4	V

**NOTE:**

- 4) Not tested in production and guaranteed by over-temperature correlation.  
 5) Not tested in production and guaranteed by design and characterization.

## TYPICAL PERFORMANCE CHARACTERISTICS

$V_{IN} = 5V$ ,  $V_{OUT1} = 1.8V$ ,  $V_{OUT2} = 1.2V$ ,  $L1 = L2 = 1.5\mu H$ ,  $F_{SW} = 2.25MHz$ ,  $T_A = 25^\circ C$ , unless otherwise noted.

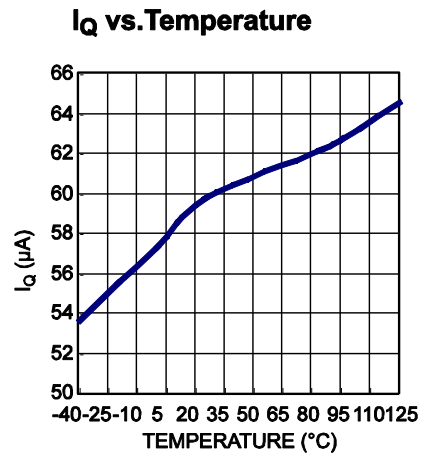
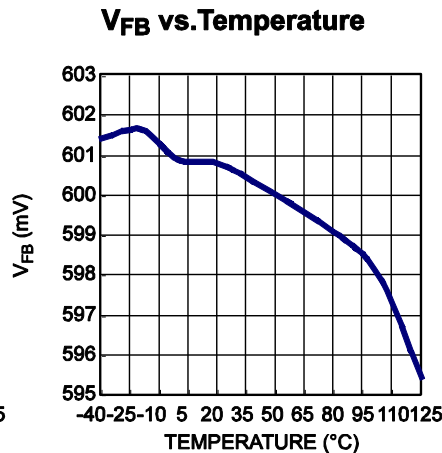
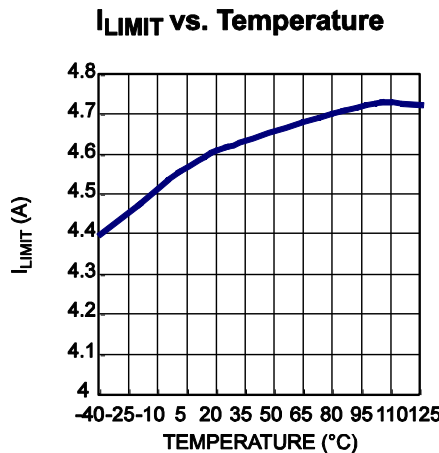
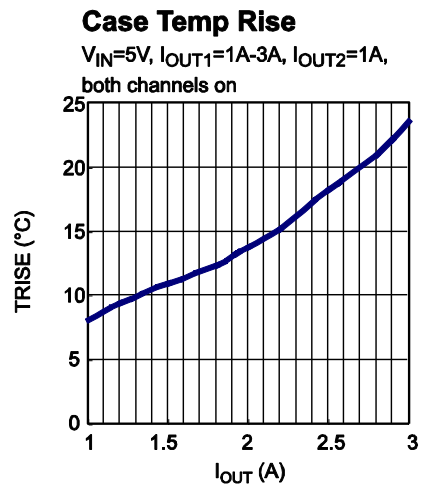
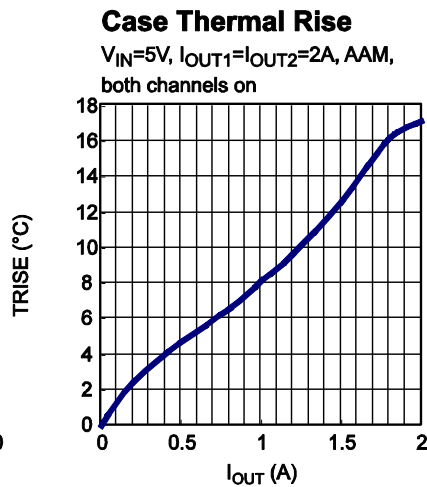
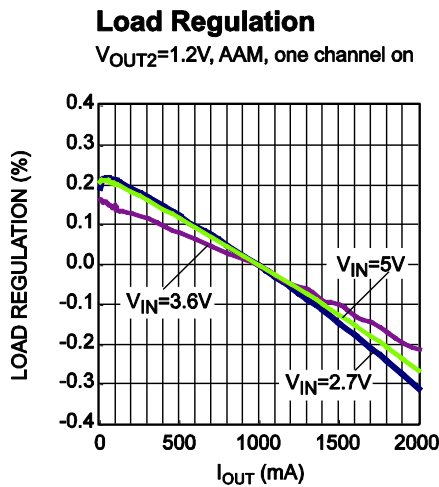
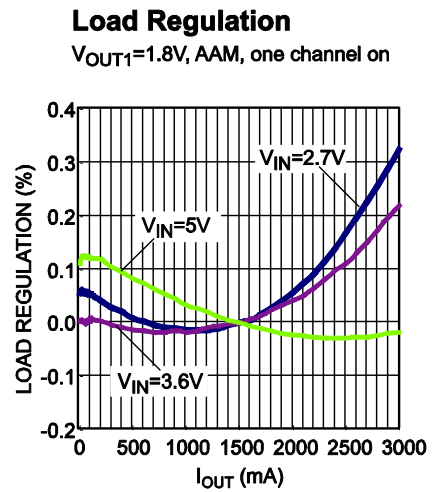
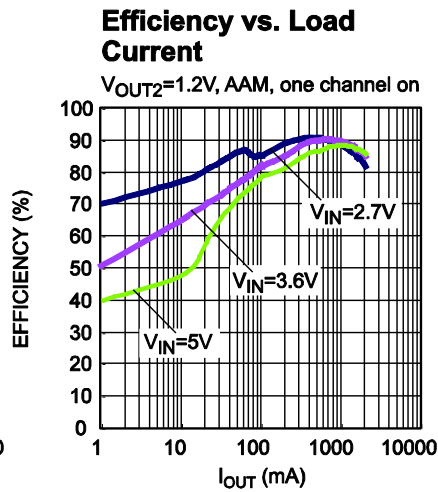
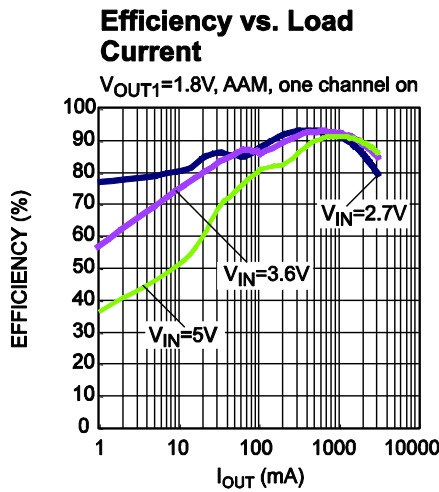

**TYPICAL PERFORMANCE CHARACTERISTICS (continued)**

$V_{IN} = 5V$ ,  $V_{OUT1} = 1.8V$ ,  $V_{OUT2} = 1.2V$ ,  $L1 = L2 = 1.5\mu H$ ,  $F_{SW} = 2.25MHz$ ,  $T_A = 25^\circ C$ , unless otherwise noted.

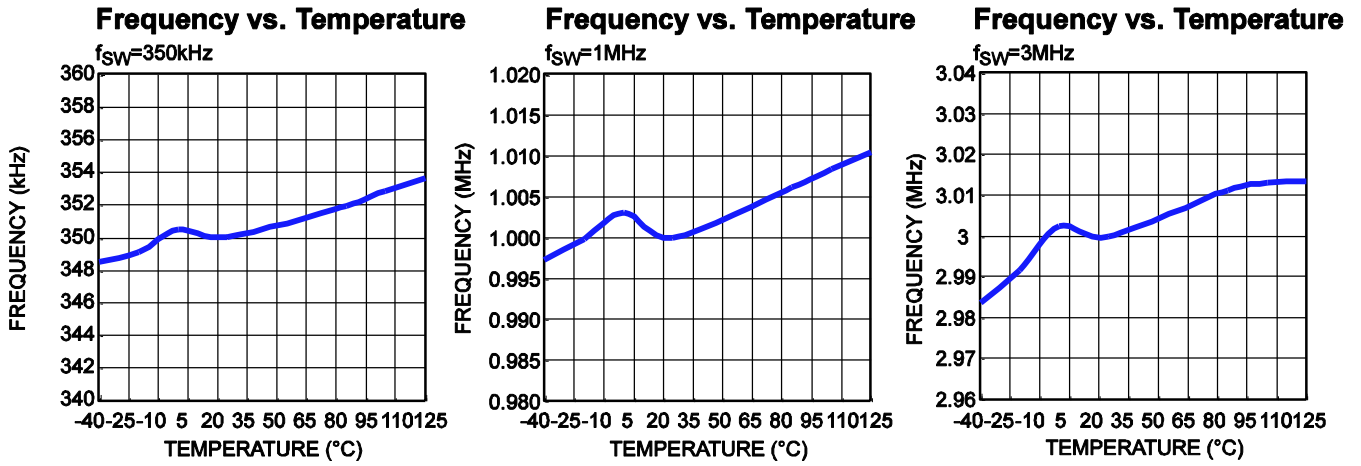

## TYPICAL PERFORMANCE CHARACTERISTICS (continued)

$V_{IN} = 5V$ ,  $V_{OUT1} = 1.8V$ ,  $V_{OUT2} = 1.2V$ ,  $L1 = L2 = 1.5\mu H$ ,  $F_{SW} = 2.25MHz$ ,  $T_A = 25^\circ C$ , unless otherwise noted.

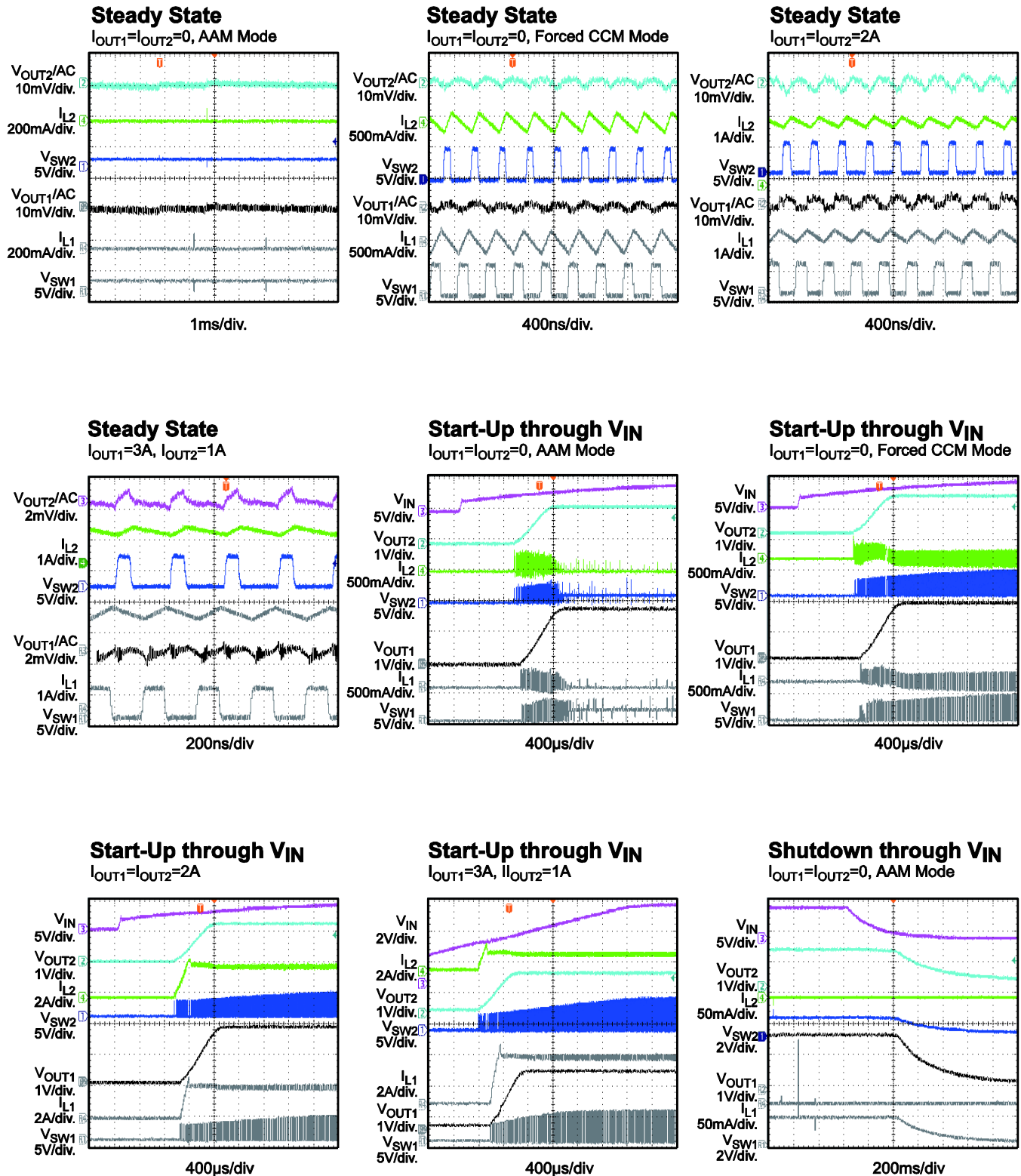



**TYPICAL PERFORMANCE CHARACTERISTICS (continued)**

$V_{IN} = 5V$ ,  $V_{OUT1} = 1.8V$ ,  $V_{OUT2} = 1.2V$ ,  $L1 = L2 = 1.5\mu H$ ,  $F_{SW} = 2.25MHz$ ,  $T_A = 25^\circ C$ , unless otherwise noted.

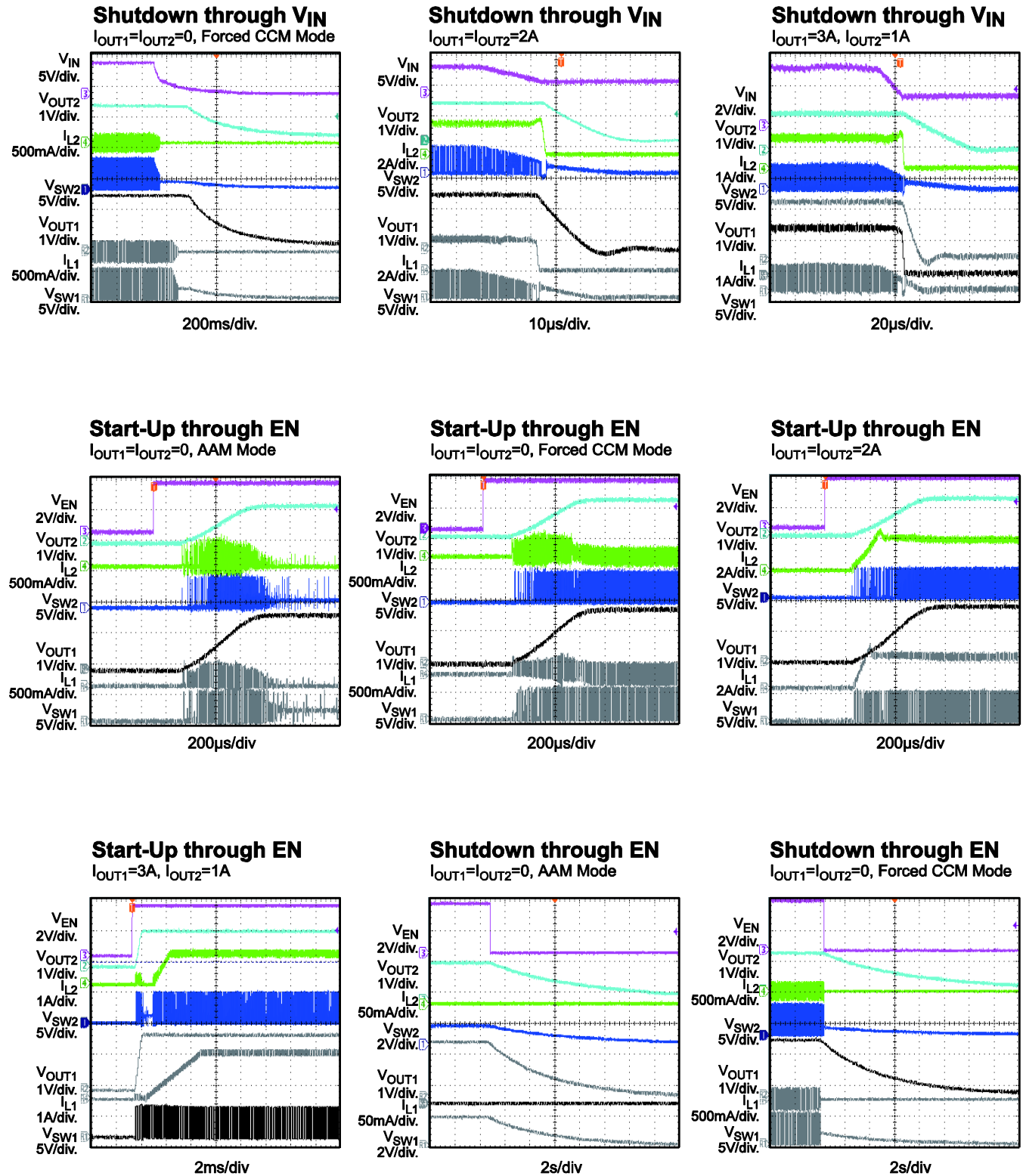

**TYPICAL PERFORMANCE CHARACTERISTICS (continued)**
 $V_{IN} = 5V$ ,  $V_{OUT1} = 1.8V$ ,  $V_{OUT2} = 1.2V$ ,  $L1 = L2 = 1.5\mu H$ ,  $F_{SW} = 2.25MHz$ ,  $T_A = 25^\circ C$ , unless otherwise noted.

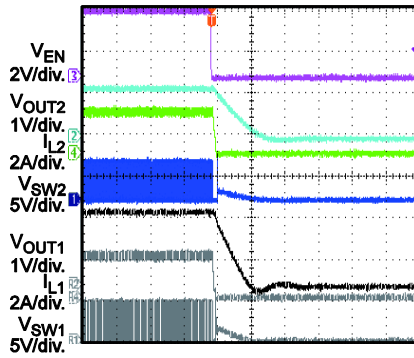
**Shutdown through EN**
 $I_{OUT1}=I_{OUT2}=2A$ 

20µs/div.

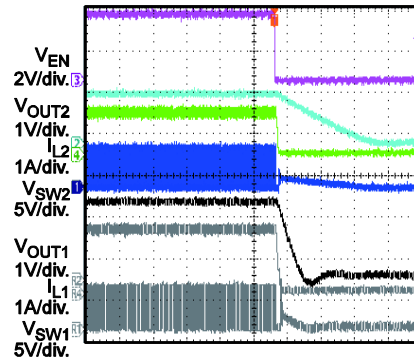
**Shutdown through EN**
 $I_{OUT1}=3A$ ,  $I_{OUT2}=1A$ 

20µs/div.

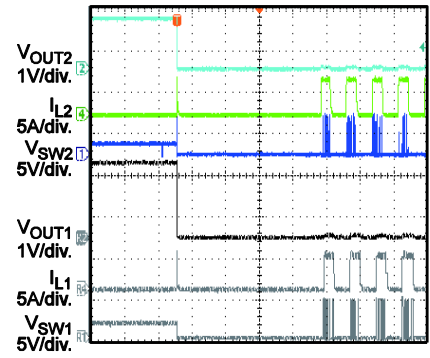
**SCP Entry**
 $I_{OUT1}=I_{OUT2}=0$ , AAM Mode

2ms/div.

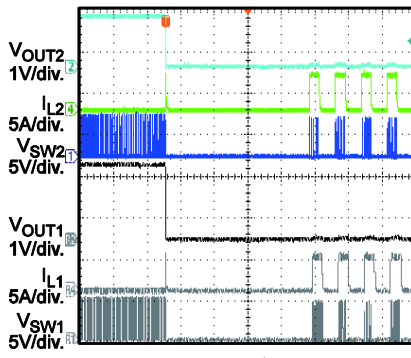
**SCP Entry**
 $I_{OUT1}=I_{OUT2}=0$ , Forced CCM Mode

2ms/div

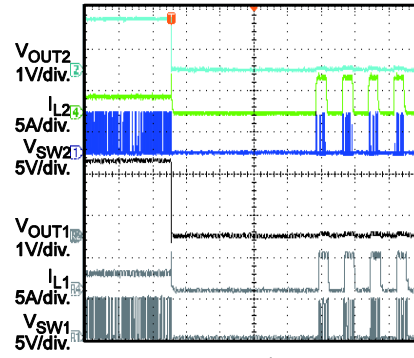
**SCP Entry**
 $I_{OUT1}=I_{OUT2}=2A$ 

2ms/div

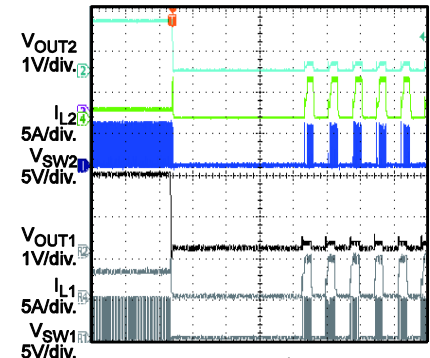
**SCP Entry**
 $I_{OUT1}=3A$ ,  $I_{OUT2}=1A$ 

2ms/div

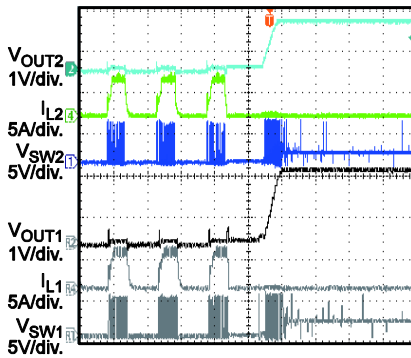
**SCP Recovery**
 $I_{OUT1}=I_{OUT2}=0$ , AAM Mode

1ms/div

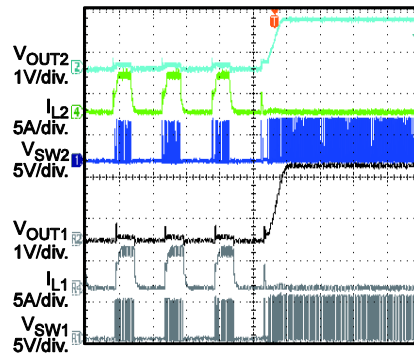
**SCP Recovery**
 $I_{OUT1}=I_{OUT2}=0$ , Forced CCM Mode

1ms/div

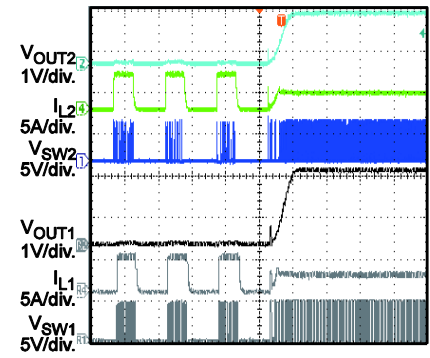
**SCP Recovery**
 $I_{OUT1}=I_{OUT2}=2A$ 

1ms/div

**TYPICAL PERFORMANCE CHARACTERISTICS (continued)**

$V_{IN} = 5V$ ,  $V_{OUT1} = 1.8V$ ,  $V_{OUT2} = 1.2V$ ,  $L1 = L2 = 1.5\mu H$ ,  $F_{SW} = 2.25MHz$ ,  $T_A = 25^\circ C$ , unless otherwise noted.

**SCP Recovery**

$I_{OUT1}=3A$ ,  $I_{OUT2}=1A$

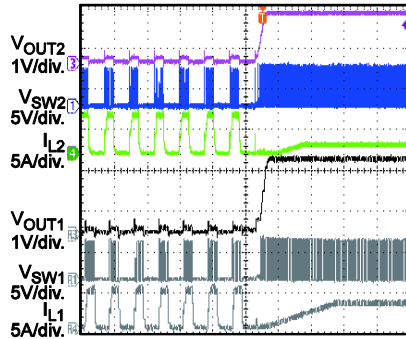

2ms/div.

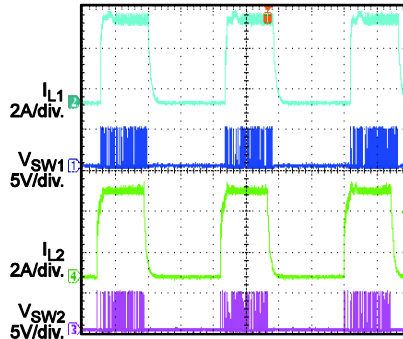
**SCP Steady State**

400µs/div.

**Load Transient**

$I_{OUT1}=I_{OUT2}=0$  to 2A, AAM Mode,  $1.6A/\mu S$  Speed

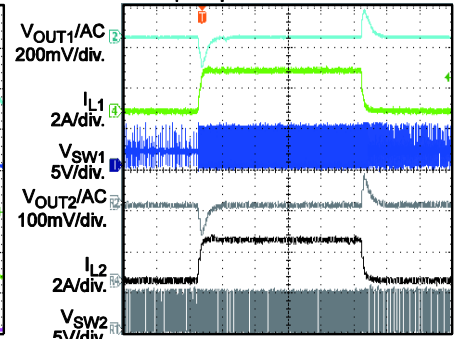

100µs/div.

**Load Transient**

$I_{OUT1}=I_{OUT2}=1$  to 2A, AAM Mode,  $1.6A/\mu S$  Speed

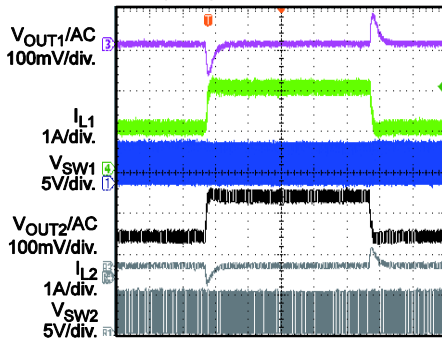

100µs/div

**Load Transient**

$I_{OUT1}=0$  to 3A,  $I_{OUT2}=0$  to 1A,  $1.6A/\mu S$  Speed

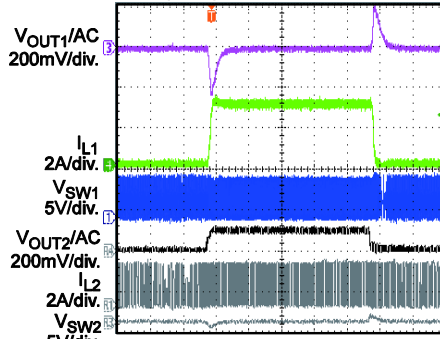

100µs/div

**Load Transient**

$I_{OUT1}=1.5$  to 3A,  $I_{OUT2}=0.5$  to 1A,  $1.6A/\mu S$  Speed

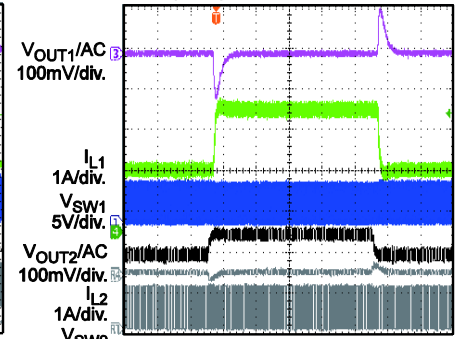

100µs/div

## PIN FUNCTIONS

Package Pin #	Name	Description
1	PGND2	<b>Power ground of channel 2.</b> Connect PGND2 with larger copper areas to the negative terminals of the input and output capacitors.
2	SW2	<b>Switch node connection to the inductor for channel 2.</b> SW2 connects to the internal high- and low-side power MOSFET switches of the channel 2 buck.
3	VIN2	<b>Input supply for channel 2.</b> A decoupling capacitor to ground is required close to VIN2 to reduce switching spikes.
4	SS2	<b>Soft start for channel 2.</b>
5	FB2	<b>Feedback for channel 2.</b> FB2 is the input to the error amplifier of channel 2. An external resistive divider connects FB2 between the output and ground. The voltage on FB2 compares to the internal 0.6V reference to set the regulation voltage of channel 2.
6	AGND	<b>Analog ground.</b> Connect AGND to PGND externally.
7	VCC	<b>Power supply to the internal regulator for both channels.</b> Decouple with a 0.1 $\mu$ F to 1 $\mu$ F capacitor between VCC and AGND.
8	CCM	<b>AAM or forced CCM control.</b> Pull CCM high to enter forced CCM mode; pull CCM low to enter AAM mode at light load. Do not float CCM.
9	FB1	<b>Feedback for channel 1.</b> FB1 is the input to the error amplifier of channel 1. An external resistive divider connects FB1 between the output and GND. The voltage on FB1 compares to the internal 0.6V reference to set the regulation voltage of channel 1.
10	SS1	<b>Soft start for channel 1.</b>
11	VIN1	<b>Input supply for channel 1.</b> A decoupling capacitor to ground is required close to VIN1 to reduce switching spikes.
12	SW1	<b>Switch node connection to the inductor for channel 1.</b> SW1 connects to the internal high- and low-side power MOSFET switches of the channel 1 buck.
13	PGND1	<b>Power ground of channel 1.</b> Connect PGND1 with larger copper areas to the negative terminals of the input and output capacitors.
14	PG1	<b>Power good for channel 1.</b>
15	EN1	<b>Enable control for channel 1.</b>
16	FREQ	<b>Frequency set.</b> Connect a resistor to GND to set the switching frequency. The switching frequency can be synchronized by an external clock via FREQ.
17	EN2	<b>Enable control for channel 2.</b>
18	PG2	<b>Power good for channel 2.</b>

## BLOCK DIAGRAM

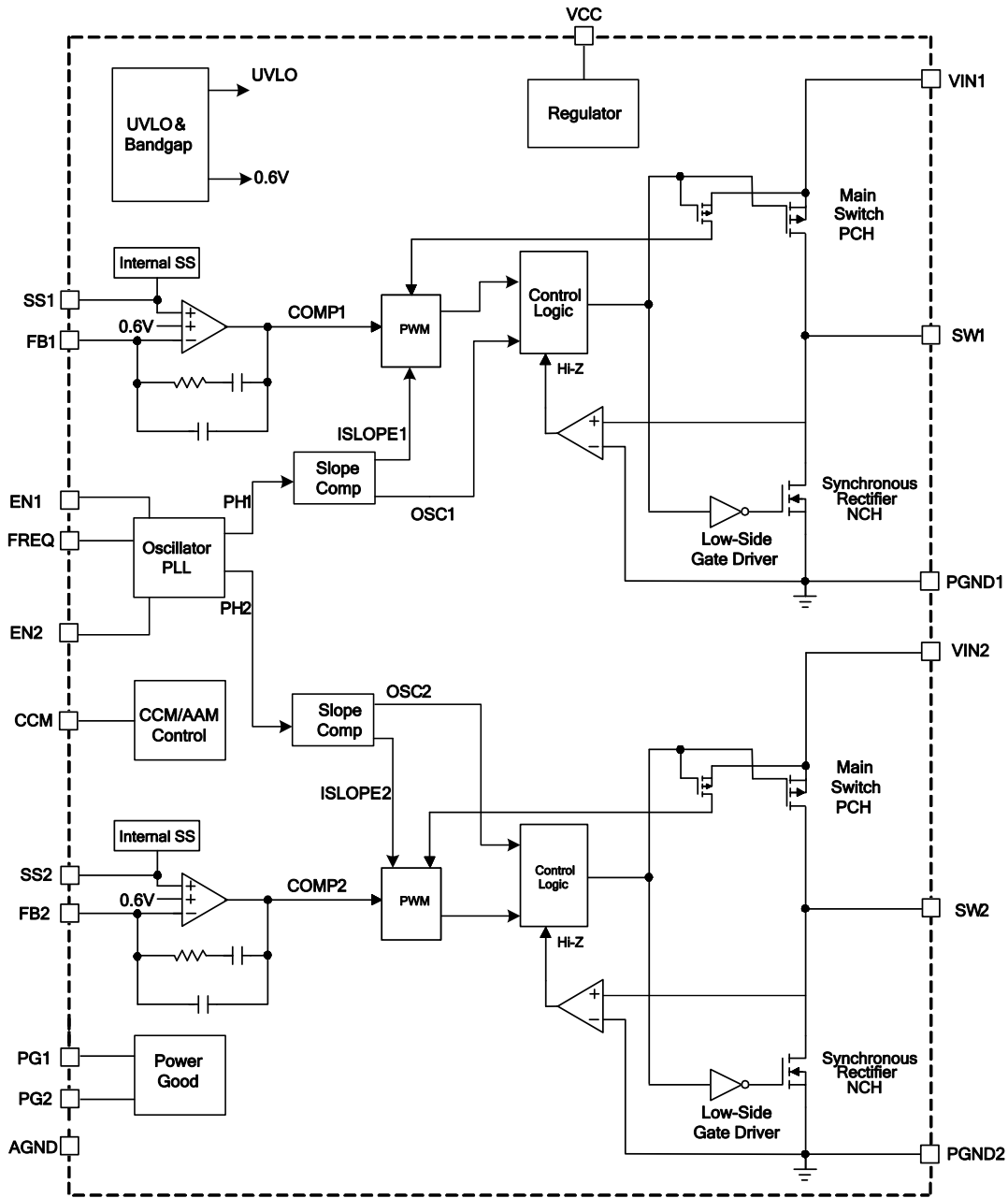

Figure 1: Functional Block Diagram

## OPERATION

The MP2166 is a fully integrated, dual-channel, synchronous, step-down converter. Both channels use peak-current-mode control with internal compensation for fast transient response and cycle-to-cycle current limit.

The MP2166 is optimized for low-voltage, portable applications where efficiency and small size are critical.

### 180° Out-of-Phase Operation

The MP2166 operates the two channels in 180° out-of-phase operation to reduce input current ripple so a smaller input bypass capacitor can be used. When both channels operate in CCM, two internal clocks are used (see Figure 2). The high-side MOSFET is turned on at the clock rising edge of the corresponding channel.

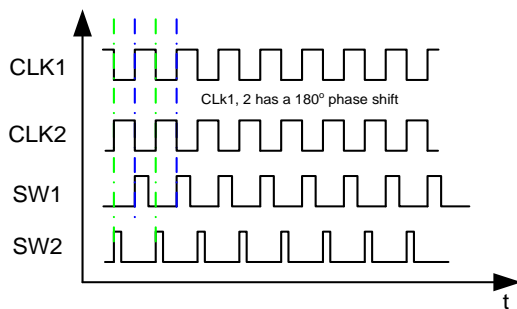

**Figure 2: 180° Out-of-Phase Operation**

At low dropout, when the switching frequency is stretched out for each channel, the MP2166 runs at a fixed-off time with its own independent switching frequency. After the input voltage rises high again, frequency stretch mode ends, and PWM mode resumes and synchronizes with the master oscillator for out-of-phase operation.

### Light-Load Operation

In light-load condition, the MP2166 can work in two different operating modes by setting CCM to different statuses.

The MP2166 works in forced continuous conduction mode (CCM) when the CCM pin is pulled higher than 1.6V. The MP2166 works with fixed frequency from no load to full load in this mode. The advantage of CCM is the controllable frequency and lower output ripple at light load.

The shutdown current in forced CCM mode (50µA at 3.3V) is much higher than AAM mode due to some internal circuits are active. It is recommended to pull CCM pin LOW when part is shutdown if the high shutdown current is cared.

The MP2166 works in advanced asynchronous mode (AAM) when CCM is pulled lower than 0.4V. AAM is used to optimize efficiency during light-load and no-load conditions.

When AAM mode is enabled, the MP2166 first enters non-synchronous operation as the inductor current approaches zero at light load. If the load decreases further or is at no load, which makes the internal COMP voltage ( $V_{COMP}$ ) decrease to the set value, then the MP2166 enters AAM. In AAM, the internal clock is reset whenever  $V_{COMP}$  crosses over the set value, and the crossover time is taken as the benchmark of the next clock. When the load increases and  $V_{COMP}$  is higher than the set value, the operation mode is in DCM or CCM, which has a constant switching frequency.

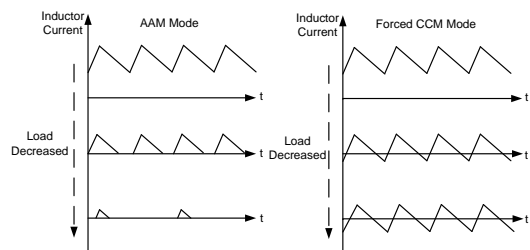

**Figure 3: AAM Mode and Forced CCM Mode**

### Soft Start (SS)

The MP2166 has a built-in soft start that ramps up the output voltage at a controlled slew rate, preventing an overshoot at start-up. The soft-start time is about 0.5ms, typically.

The soft-start time can also be programmed by an external capacitor connected to SS, shown in Equation (1):

$$t_{SS}(\text{ms}) = \frac{C_{SS}(\text{nF}) \times V_{REF}(\text{V})}{I_{SS}(\mu\text{A})} \quad (1)$$

Where  $C_{SS}$  is the external SS capacitor,  $V_{REF}$  is the internal reference voltage (0.6V), and  $I_{SS}$  is the 3.2µA SS charge current.

### Oscillator and Sync Function

The internal oscillator frequency is set by a single external resistor ( $R_{\text{FREQ}}$ ) connected between FREQ and ground. The frequency setting resistor should be located close to the device. The relationship between the oscillator frequency and  $R_{\text{FREQ}}$  is shown in Figure 4.

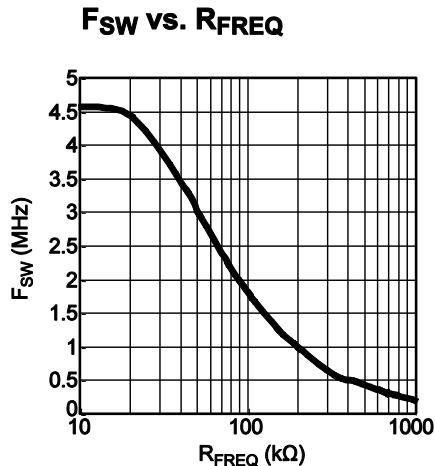

Figure 4:  $F_{\text{SW}}$  vs.  $R_{\text{FREQ}}$

FREQ can also be used to synchronize the internal oscillator to an external clock. The rising edge of the channel 1 clock is synchronized to the external clock rising edge, while the channel 2 clock remains at 180° out-of-phase to channel 1. The recommended external SYNC frequency is in the range of 350kHz to 3MHz. While there is no pulse width requirement, note that there is always parasitic capacitance of the pad there, so if the pulse width is too short, a clear rising and falling edge may not be seen. The pulse is recommended to be longer than 100ns.

### Power Good (PG)

The MP2166 has one power good (PG) output to indicate normal operation after the soft-start time. PG is the open drain of an internal MOSFET. It should be connected to VIN, VCC, or an external voltage source through a resistor (i.e.: 100k $\Omega$ ). After the input voltage is applied, the MOSFET is turned on and PG is pulled to GND before SS is ready. After the FB voltage reaches 82% of the reference voltage ( $V_{\text{REF}}$ ), the MOSFET turns off and PG is pulled high by an external voltage source. When the FB voltage drops to 76% of  $V_{\text{REF}}$ , the PG voltage is pulled to GND to indicate a failure output.

### Current Limit and Short Circuit

Each channel of the MP2166 has a typical 4.5A current limit for the high-side switch. When the current limit condition is sustained for a pre-defined period of time, the MP2166 treats this as a short and attempts to recover with hiccup mode.

In hiccup mode, the MP2166 disables the output power stage, slowly discharges the soft-start cap, and soft starts automatically. If the short-circuit condition still remains, the MP2166 repeats this operation cycle until the short circuit is removed and the output rises back to regulation levels.

### Dropout Operation

The MP2166 allows the high-side switch to remain on for more than one switching cycle and increases the duty cycle while the input voltage drops down to the output voltage. When the duty cycle reaches 100%, the high-side switch is on to deliver current to the output up to its current limit. The output voltage is then the difference between the input voltage and the voltage drop across the main switch and the inductor.

## APPLICATION INFORMATION

### Setting the Output Voltage

The external resistor divider sets the output voltage. The feedback resistor (R1) also sets the feedback loop bandwidth with the internal compensation (see Figure 5).

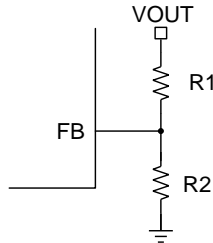

**Figure 5: External Resistor Divider**

In the case of ceramic capacitors used as output capacitors ( $C_O$ ), the feedback loop bandwidth ( $f_C$ ) is no higher than 1/10 of the switching frequency for optimal transient performance and good phase margin. If an electrolytic capacitor is used, the loop bandwidth is no higher than 1/4 of the ESR zero frequency ( $f_{ESR}$ ).  $f_{ESR}$  can be calculated by Equation (2):

$$f_{ESR} = \frac{1}{2\pi \times R_{ESR} \times C_O} \quad (2)$$

For example, choose  $f_C = 80\text{kHz}$  with a ceramic capacitor and  $C_O = 22\mu\text{F}$ .

R1 is estimated to be 100kΩ. R2 can then be calculated with Equation (3):

$$R2 = \frac{R1}{\frac{V_{OUT}}{0.6V} - 1} \quad (3)$$

Use Table 1 to select resistor values based on different output voltages.

**Table 1: Resistor Selection vs. Output Voltage Setting**

V <sub>OUT</sub>	R1	R2
1.2V	100kΩ	100kΩ
1.5V	100kΩ	66.5kΩ
1.8V	100kΩ	49.9kΩ
2.5V	100kΩ	31.6kΩ
3.3V	100kΩ	22.1kΩ

### Inductor Selection

An inductor with a DC current rating at least 25% higher than the maximum load current is recommended for most applications. For best efficiency, the inductor DC resistance should be less than 20mΩ. For most designs, the inductance value can be derived from Equation (4):

$$L = \frac{V_{OUT} \times (V_{IN} - V_{OUT})}{V_{IN} \times \Delta I_L \times f_{SW}} \quad (4)$$

Where  $\Delta I_L$  is inductor ripple current. Choose the inductor ripple current to be approximately 30% of the maximum load current.

The maximum inductor peak current can be calculated with Equation (5):

$$I_{L(MAX)} = I_{LOAD} + \frac{\Delta I_L}{2} \quad (5)$$

### Input Capacitor Selection

The input capacitor reduces the surge current drawn from the input and the switching noise from the device. The input capacitor impedance at the switching frequency should be less than the input source impedance to prevent high-frequency switching current from passing to the input source. Ceramic capacitors with X5R or X7R dielectrics are highly recommended because of their low ESR and small temperature coefficients. For most applications, a 22μF capacitor is sufficient.

### Output Capacitor Selection

The output capacitor ( $C_O$ ) keeps the output voltage ripple small and ensures a stable regulation loop. The output capacitor impedance should be low at the switching frequency. Use ceramic capacitors with X5R or X7R dielectrics. If an electrolytic capacitor is used, pay close attention to the output ripple voltage, extra heating, and the selection of the upper feedback resistor due to the large ESR of electrolytic capacitor (refer to the Setting the Output Voltage section). The output ripple ( $\Delta V_{OUT}$ ) can be approximated with Equation (6):

$$\Delta V_{OUT} = \frac{V_{OUT} \times (V_{IN} - V_{OUT})}{V_{IN} \times L \times f_{SW}} \times \left( ESR + \frac{1}{8 \times f_{SW} \times C_O} \right) \quad (6)$$



## Power Dissipation

IC power dissipation is important in circuit design, not only because of efficiency concerns, but also because of the chip's thermal requirements. Several parameters influence power dissipation, such as conduction loss (Cond), dead time (DT), switching loss (SW), MOSFET driver current (DR), and supply current (S).

Based on these parameters, we can estimate the power loss with Equation (7):

$$P_{\text{LOSS}} = P_{\text{Cond}} + P_{\text{DT}} + P_{\text{SW}} + P_{\text{DR}} + P_{\text{S}} \quad (7)$$

## Thermal Regulation

Changes in IC temperatures change the electrical characteristics, especially when the temperature exceeds the IC's recommended operating range. Managing the IC's temperature requires additional considerations to ensure that the IC runs within the maximum allowable temperature junction. Specific layout designs can improve the thermal profile while limiting costs to either the efficiency or operating range.

For the MP2166, connect the ground pin on the package to a ground plane on top of the PCB to use this plane as a heat sink. Connect this ground plane to the ground planes beneath the IC using vias to improve heat dissipation. However, given that these ground planes can introduce unwanted EMI noise and occupy valuable PCB space, design their size and shape to match the thermal resistance requirement.

Connecting the ground pin to a heat sink cannot guarantee that the IC will not exceed its recommended temperature limits (i.e.: the ambient temperature exceeds the IC's temperature limits). If the ambient air temperature approaches the IC's temperature limit, the IC can be de-rated to operate using less power and help prevent thermal damage and unwanted electrical characteristics.

**PCB Layout Guidelines<sup>(6)</sup>**

Efficient PCB layout is critical for stable operation. A four-layer layout is strongly recommended to achieve better thermal performance. For best results, refer to Figure 6 and follow the guidelines below.

1. Place the high-current paths (PGND, VIN, and SW) very close to the device with short, direct, and wide traces.
2. Place input capacitors on both VIN sides and as close to VIN and PGND as possible.
3. Place the decoupling capacitor as close to VCC and AGND as possible.
4. Keep the switching node SW short and away from the feedback network.
5. Place the external feedback resistors next to FB. Do not place vias on the FB trace.
6. Connect PGND to a large copper area to achieve better thermal performance.

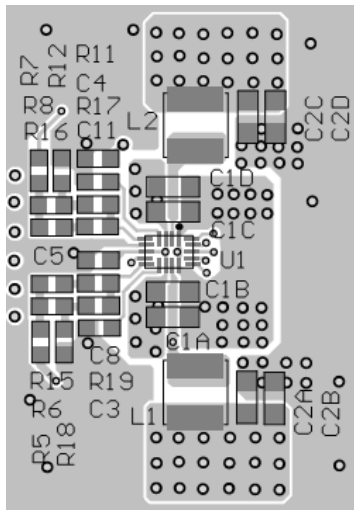

**Top Layer**

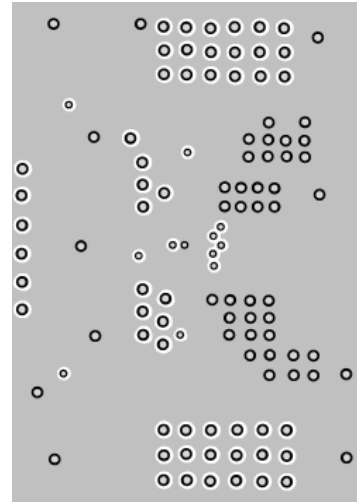

**Inner Layer 1**

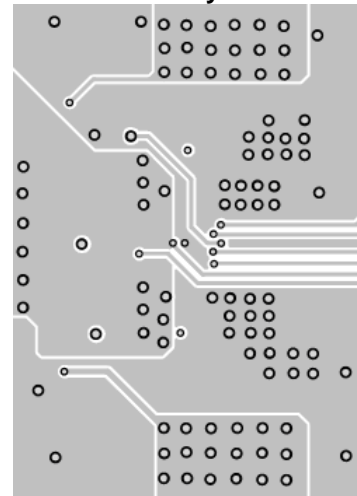

**Inner Layer 2**

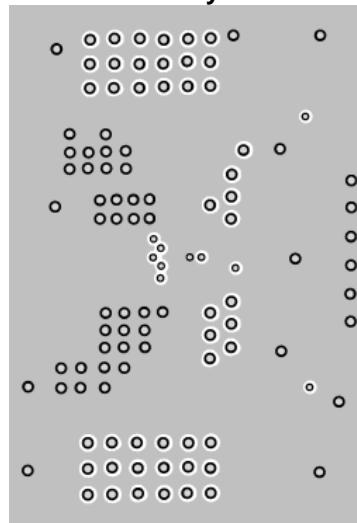

**Bottom Layer**

**Figure 6: Recommended PCB Layout**

**NOTE:**

6) The recommended PCB layout is based on Figure7

## TYPICAL APPLICATION CIRCUITS

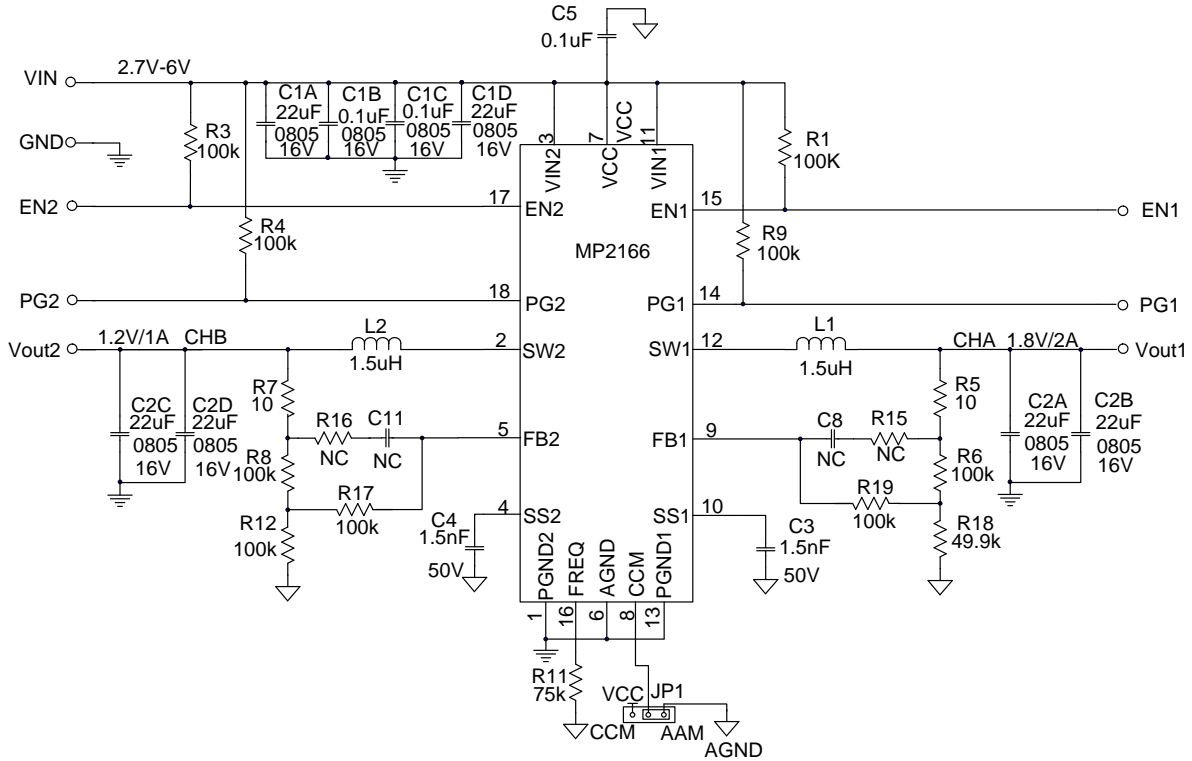

Figure 7: 2A/2A Application Circuit

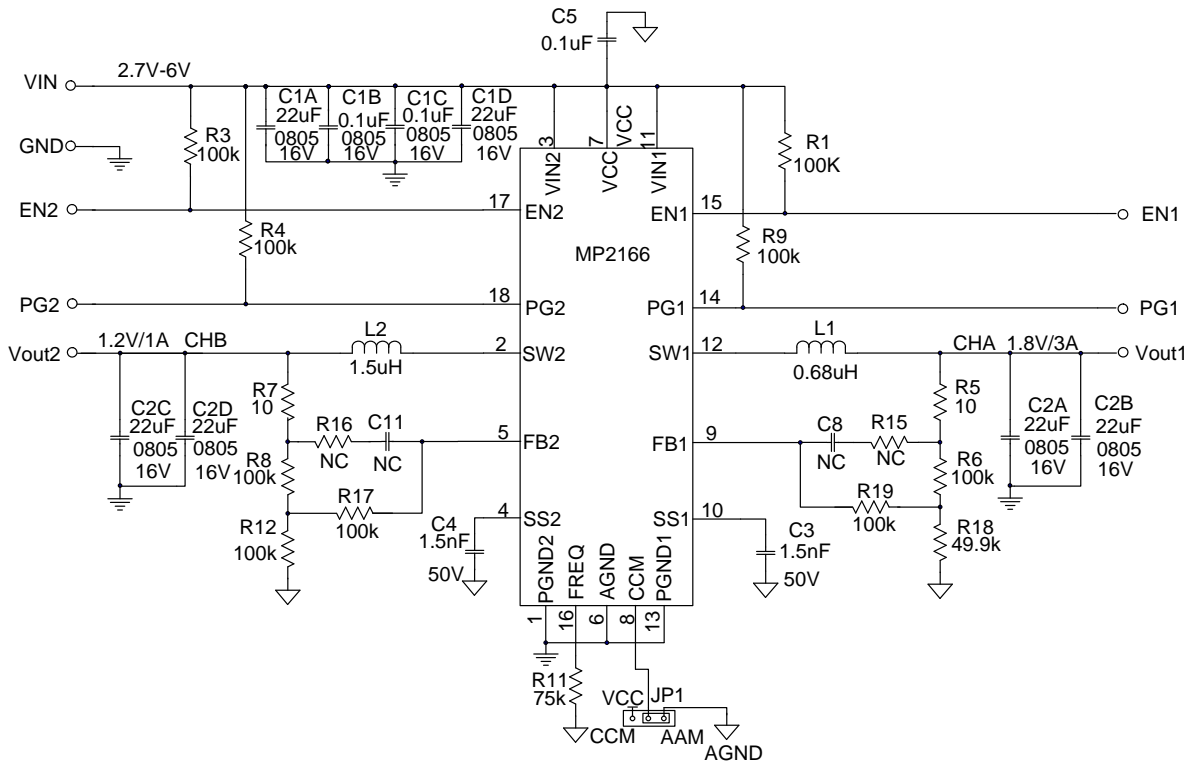
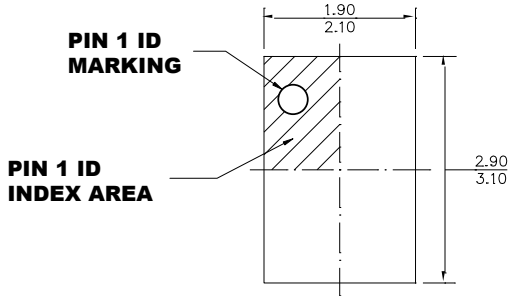

Figure 8: 3A/1A Application Circuit



## PACKAGE INFORMATION

### QFN-18 (2mmx3mm)



**TOP VIEW**

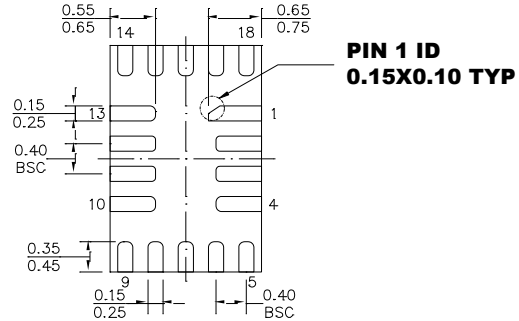

**BOTTOM VIEW**

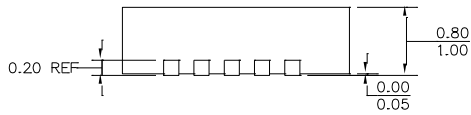

**SIDE VIEW**

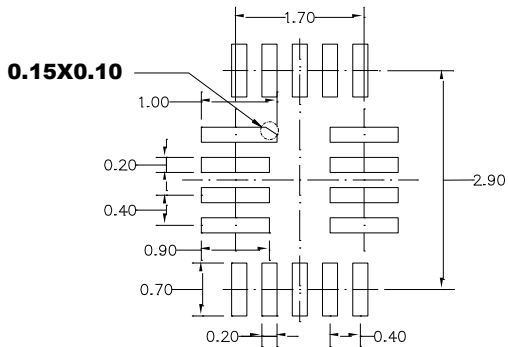

**RECOMMENDED LAND PATTERN**

#### NOTE:

- 1) ALL DIMENSIONS ARE IN MILLIMETERS.
- 2) EXPOSED PADDLE SIZE DOES NOT INCLUDE MOLD FLASH.
- 3) LEAD COPLANARITY SHALL BE 0.10 MILLIMETERS MAX.
- 4) JEDEC REFERENCE IS MO-220.
- 5) DRAWING IS NOT TO SCALE.

**NOTICE:** The information in this document is subject to change without notice. Please contact MPS for current specifications. Users should warrant and guarantee that third party Intellectual Property rights are not infringed upon when integrating MPS products into any application. MPS will not assume any legal responsibility for any said applications.