

QT-Brightek Display Series

0.40" Three Digit Display

Part No.: QBT40XXZ

XX= Color

Z= 1: Common Cathode

Z = 0: Common Anode

Product: QBT40XXZ_series	Date: September 14, 2015	Page 1 of 11
	Version# 1.2	

Table of Contents:

Introduction	3
Electrical / Optical Characteristic (Ta=25 °C)	4
Absolute Maximum Rating	4
Pin Configuration	5
Characteristic Curves.....	6
Solder Profile	8
Packing	9
Ordering Information	10
Revision History	11
Disclaimer	11

Introduction

Feature:

- 0.4" three digit seven segments display
- Low power consumption
- Packed in foam
- AllInGaP Technology R/S/Y/AG/O
- InGaN Technology IB/IG
- Z= 1:Common Cathode or 0:Common Anode
- XX= color

Description:

These 0.4" three digit, seven-segment displays are made with white segments and a grey surface. The viewing distance is up to seven meters.

Application:

- Instrument panels
- Indoor/Outdoor display board
- Audio equipment

Certification & Compliance:

- TS16949
- ISO9001
- RoHS Compliant



Dimension:

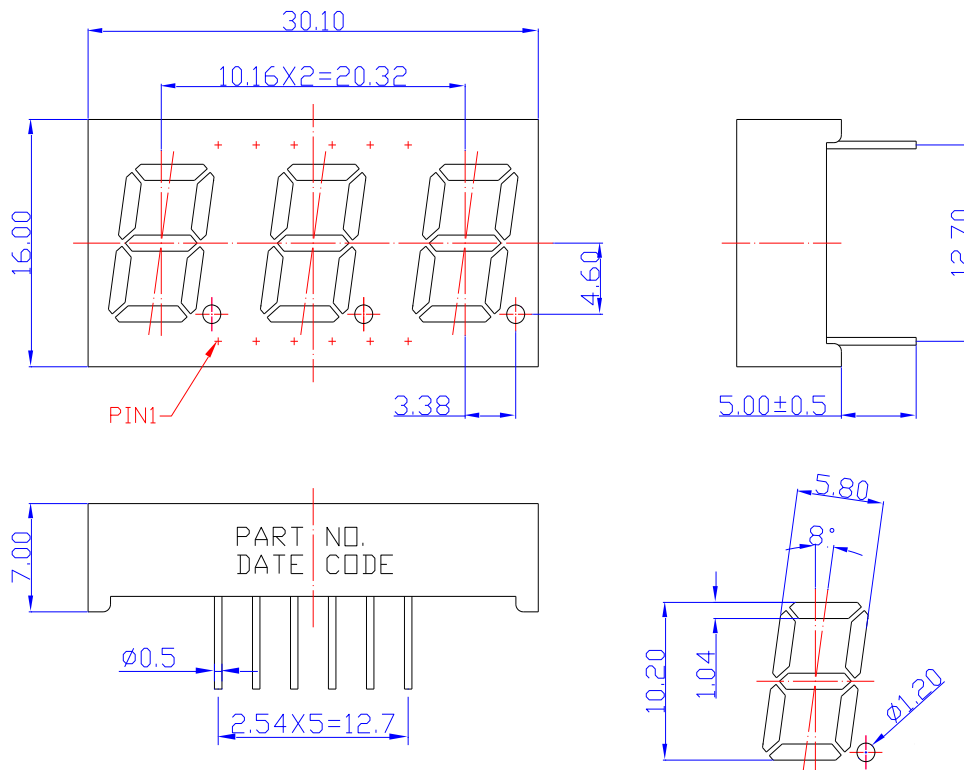

Units: mm / tolerance = +/-0.25mm

Electrical / Optical Characteristic (Ta=25 °C)

Product		Material	Color	I _F (mA)	V _F (V)		λ _D (nm)			I _V (mcd)
CC	CA				Typ.	Max.	Min.	Typ.	Max.	Typ.
QBT40R1	QBT40R0	AllnGaP	Red	20	2.0	2.6	-	625	-	40
QBT40S1	QBT40S0	AllnGaP	Deep Red	20	2.0	2.6	-	639	-	25
QBT40Y1	QBT40Y0	AllnGaP	Yellow	20	2.0	2.6	-	590	-	60
QBT40O1	QBT40O0	AllnGaP	Orange	20	2.0	2.6	-	606	-	60
QBT40AG1	QBT40AG0	AllnGaP	Yellow Green	20	2.1	2.6	-	571	-	25
QBT40IG1	QBT40IG0	InGaN	True Green	20	3.2	4.0	-	525	-	200
QBT40IB1	QBT40IB0	InGaN	Blue	20	3.0	4.0	-	465	-	40

Absolute Maximum Rating

Material	P _d (mW)	Derating liner from 25 °C per dice (mA/°C)	I _F (mA)	I _{PF} (mA)*	V _R (V)	T _{OP} (°C)	T _{ST} (°C)
AllnGaP	70	0.33	25	90	5	-25 to +85	-25 to +85
InGaN	120	0.4	30	100	5	-25 to +85	-25 to +85

*Duty 1/10 @ 1KHz

Pin Configuration

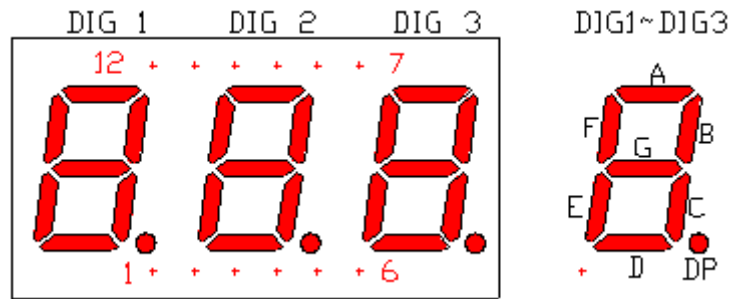

CC

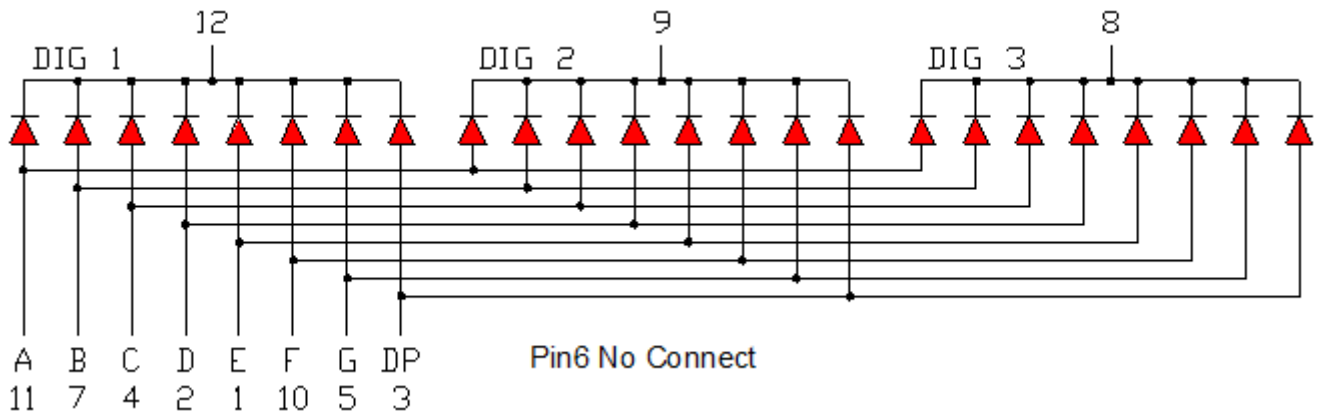

CA

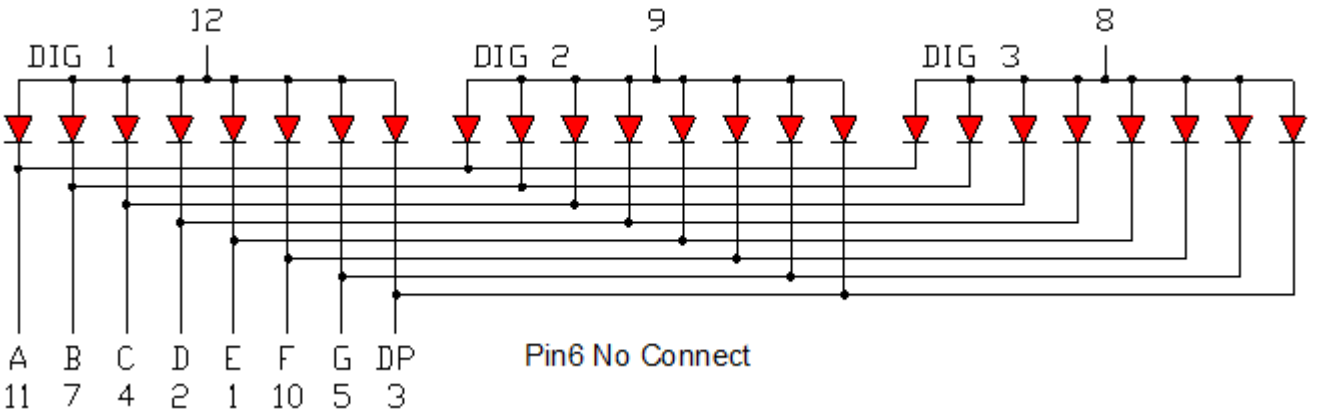

Characteristic Curves

AllnGaP

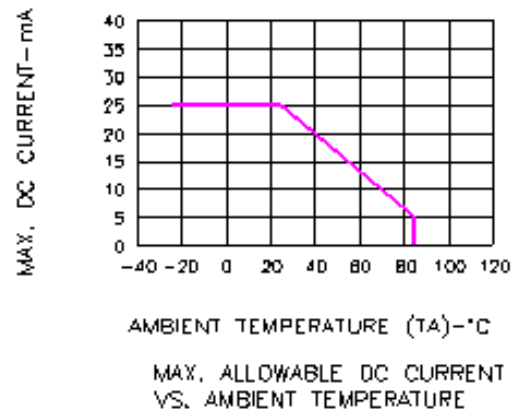
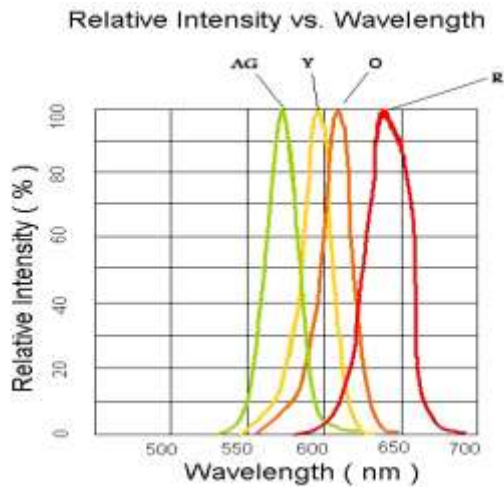
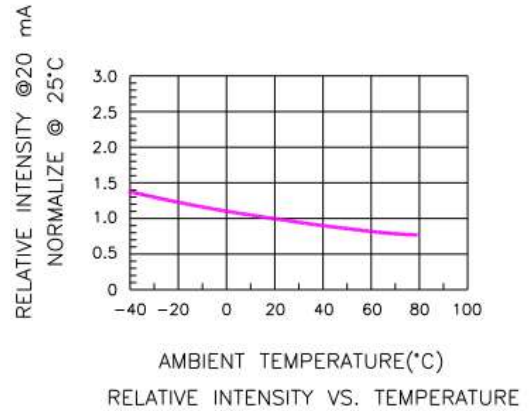
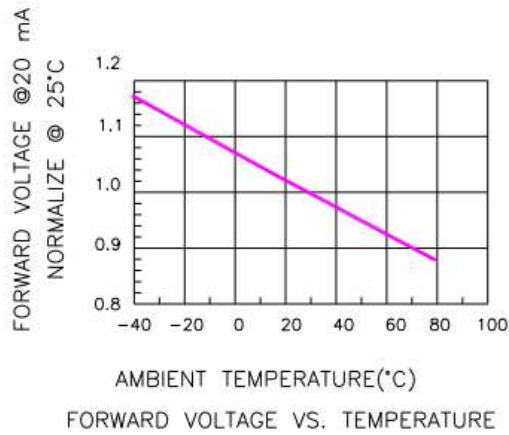
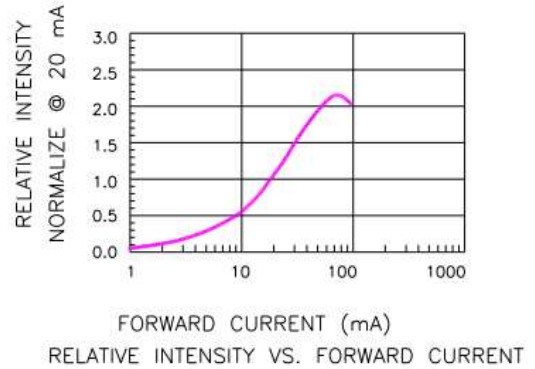
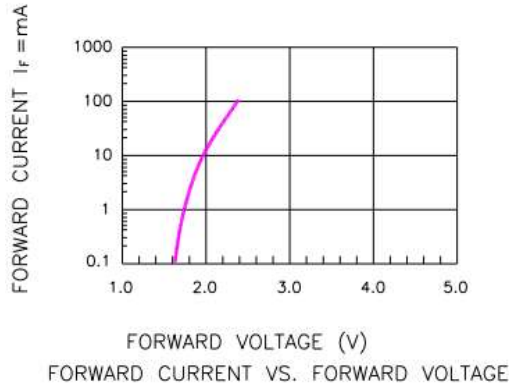

InGaN

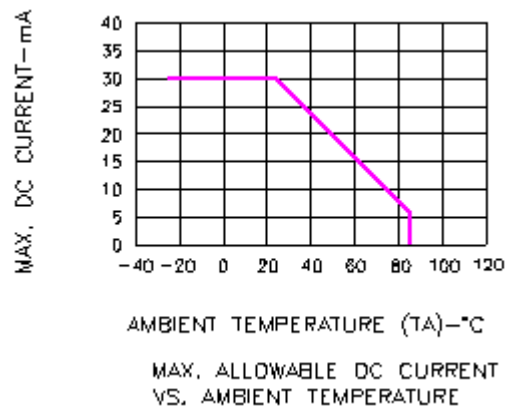
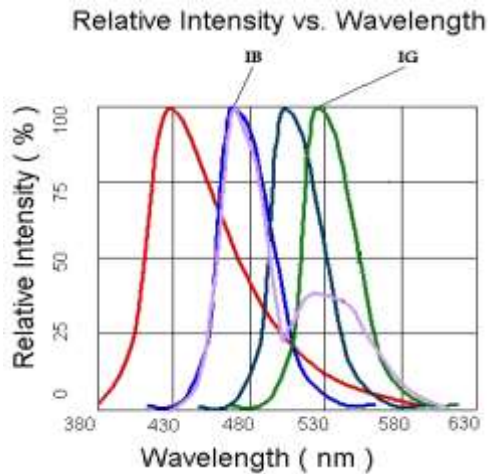
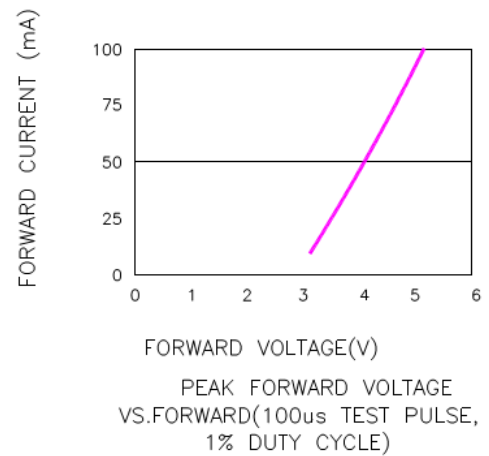
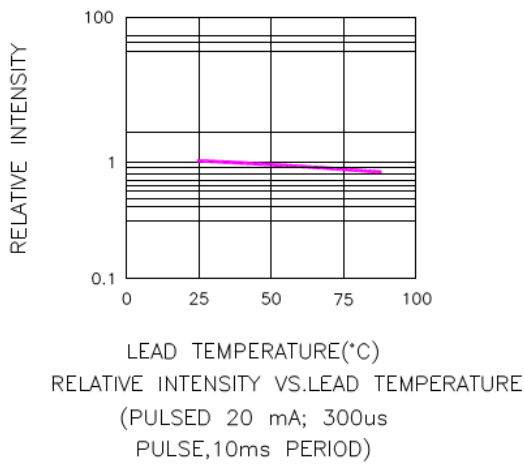
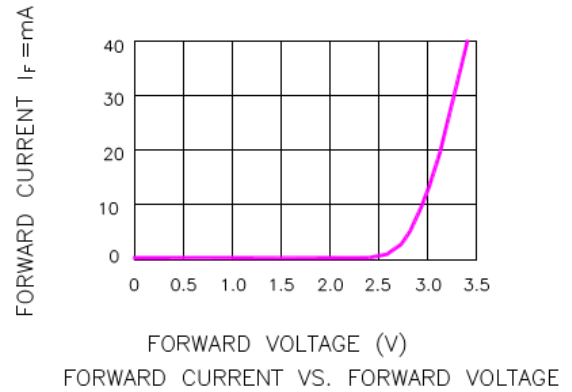
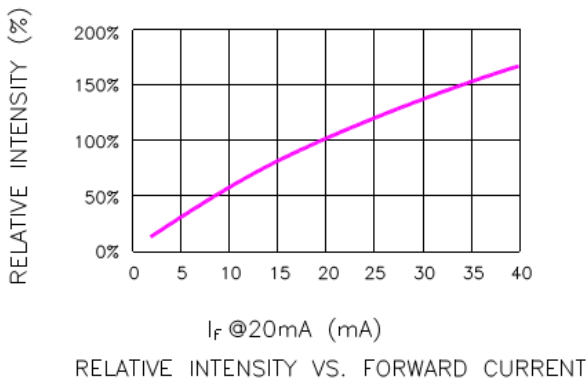

Solder Profile

Recommended Solder Profile

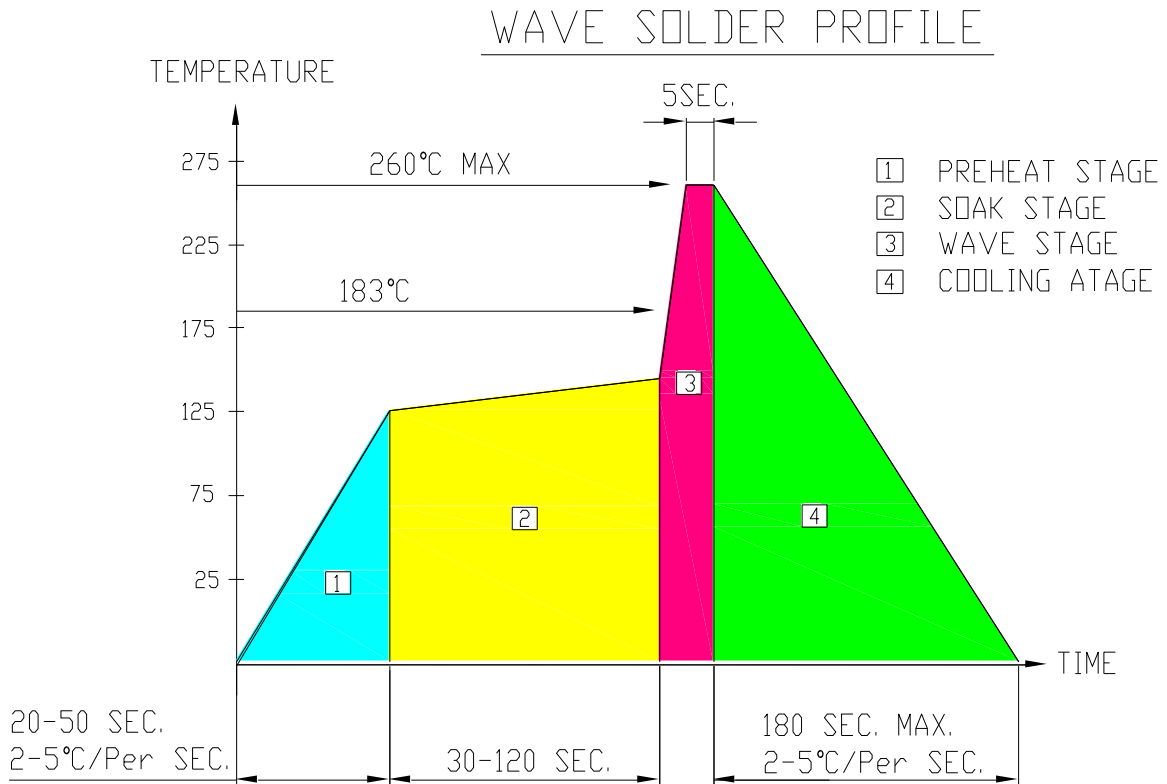

Packing

168 PCS / 1 White Polyform (14 X 12 PCS)



5 White Polyform / 1 BAG
840 PCS / 1 Inner Carton



A reference for packing within bag.

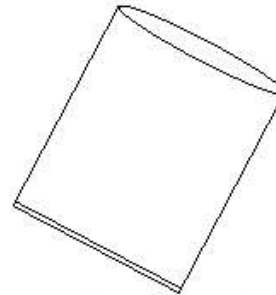

BAG SIZE : 450X410X560

840 PCS / 1 INNER CARTON & 1680 PCS / 2 INNER CARTON / 1 OUTER CARTON

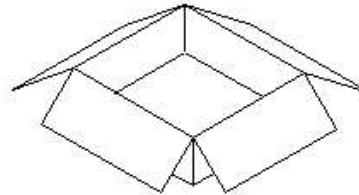

INNER BOX SIZE : 394 x 370 x 138 mm

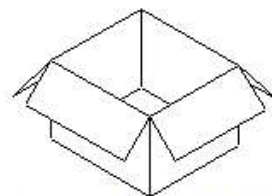

OUTER BOX SIZE : 430 x 380 x 300 mm

Product: QBT40XXZ_series	Date: September 14, 2015	Page 9 of 11
	Version# 1.2	

Ordering Information

Product		Orderable Part #		Spec Range	Quantity per foam
CC	CA	CC	CA		
QBT40R1	QBT40R0	QBT40R1	QBT40R0	I _v =40mcd typ. @ I _F =20mA, λ _D =625nm typ.	168pcs
QBT40S1	QBT40S0	QBT40S1	QBT40S0	I _v =25mcd typ. @ I _F =20mA, λ _D =639nm typ.	168pcs
QBT40Y1	QBT40Y0	QBT40Y1	QBT40Y0	I _v =60mcd typ. @ I _F =20mA, λ _D =590nm typ.	168pcs
QBT40O1	QBT40O0	QBT40O1	QBT40O0	I _v =60mcd typ. @ I _F =20mA, λ _D =606nm typ.	168pcs
QBT40AG1	QBT40AG0	QBT40AG1	QBT40AG0	I _v =25mcd typ. @ I _F =20mA, λ _D =571nm typ.	168pcs
QBT40IG1	QBT40IG0	QBT40IG1	QBT40IG0	I _v =200mcd typ. @ I _F =20mA, λ _D =525nm typ.	168pcs
QBT40IB1	QBT40IB0	QBT40IB1	QBT40IB0	I _v =40mcd typ. @ I _F =20mA, λ _D =465nm typ.	168pcs

Revision History

Description:	Revision #	Revision Date
New Release of QBT40XXZ_series	V1.0	06/24/2011
Update binning, solder profile and packing specs	V1.1	03/14/2012
Update format / Add more color options	V1.2	09/14/2015

Disclaimer

QT-BRIGHTTEK reserves the right to make changes without further notice to any products herein to improve reliability, function or design. QT-BRIGHTTEK does not assume any liability arising out of the application or use of any product or circuit described herein; neither does it convey any license under its patent rights, nor the rights of others.

Life Support Policy

QT-BRIGHTTEK's products are not authorized for use as critical components in life support devices or systems without the express written approval of QT-BRIGHTTEK. As used herein:

1. Life support devices or systems are devices or systems which, (a) are intended for surgical implant into the body, or (b) support or sustain life, and (c) whose failure to perform when properly used in accordance with instructions for use provided in the labeling, can be reasonably expected to result in a significant injury of the user.
2. A critical component in any component of a life support device or system whose failure to perform can be reasonably expected to cause the failure of the life support device or system, or to affect its safety or effectiveness.