

ACE2V3225

Automotive grade common-mode chip inductor



Product features

- AEC-Q200 qualified
- Compliant to OPEN Alliance 2.0
- 1210 (3225 metric) package
- Moisture sensitivity level (MSL): 1

Applications

- Ethernet architectures
- Advanced driver assistance systems (ADAS)
- Infotainment, safety cameras, sensors,
- Electric vehicle (xEV)
- Powertrain

Environmental compliance and general specifications

- Storage temperature rang (Component):
-40 °C to +125 °C
- Operating temperature range: -40 °C to +125 °C
(ambient plus self-temperature rise)
- Solder reflow temperature:
J-STD-020 (latest revision) compliant



Product specifications

Part number	Common-mode impedance Z (Ω) at 10 MHz (1,4) - (2,3)	Common-mode inductance (μH) at 100 kHz, 0.1 Vrms (1-2), (3-4)	DCR ¹ (Ω) @ +25 °C maximum	I _{rated} ² (mA) maximum	Rated voltage (Vdc) maximum	Insulation resistance (MΩ) minimum	Hipot ³ (Vdc)
ACE2V3225-101-R	1500 minimum 3000 typical	80 -30%/+50%	3.12	100	50	10	125
ACE2V3225-201-R	6500 minimum 9500 typical	200 -10%/+30%	5.5	70	50	10	125

1. Direct current resistance (DCR) test parameters: (1-2), (3-4), 4-wire method, +25 °C
2. I_{rated}: Maximum DC current for an approximate temperature rise of 40 °C: (1-2), (3-4)
3. Hi-pot test parameters: Winding - Winding, 5 s, Leakage current <1 mA

4. Part Number Definition: ACE2V3225-xxx-R
ACE2V3225 = Product code and size
xxx= inductance value in μH, last character equals number of zeros
-R suffix = RoHS compliant

Mechanical parameters, schematic, pad layout (mm)

Drawing not to scale--(Pin numbers and dots are reference only-no polarity)

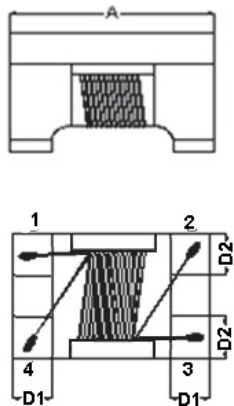

Recommended pad layout

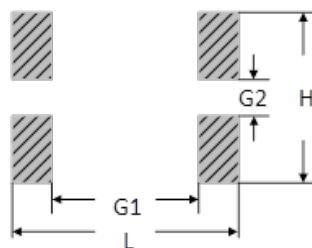

Schematic

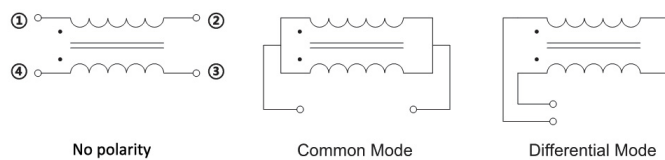

Part number	A	B	C	D1	D2	L	H	G1	G2
ACE2V3225-xxx-R	3.3 ±0.2	2.5 ±0.2	2.5 max	0.55 ±0.15	1.0 ±0.2	3.7	2.8	2.4	0.6

Part marking: No marking
All soldering surfaces to be coplanar within 0.1 millimeters
Tolerances are ±0.5 millimeters unless stated otherwise
Pad layout dimensions are reference only
Traces or vias underneath the inductor is not recommended

Packaging information (mm)

Supplied in tape and reel packaging, 2000 parts per 7" diameter reel (EIA-481 compliant)

Drawing not to scale

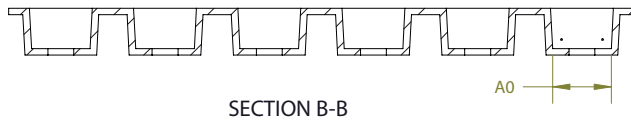
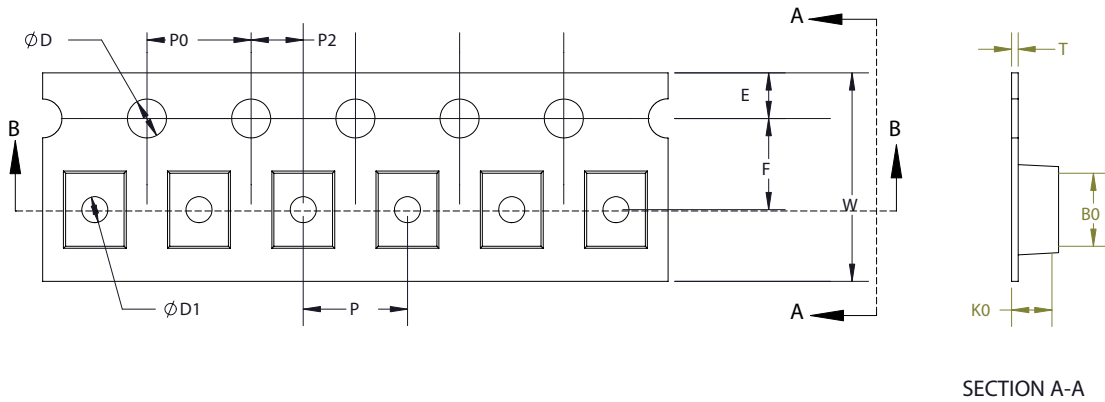

$W \pm 0.1$	8.0
$F \pm 0.05$	3.5
$E \pm 0.10$	1.75
$P0 \pm 0.10$	4.0
$P \pm 0.10$	4.0
$P2 \pm 0.05$	2.0
$D + 0.10 / -0$	1.5
$D1 \pm 0.10$	1.0
$A0 \pm 0.10$	2.88
$B0 \pm 0.10$	3.72
$K0 \pm 0.10$	2.5
$T \pm 0.05$	0.26

Performance curves

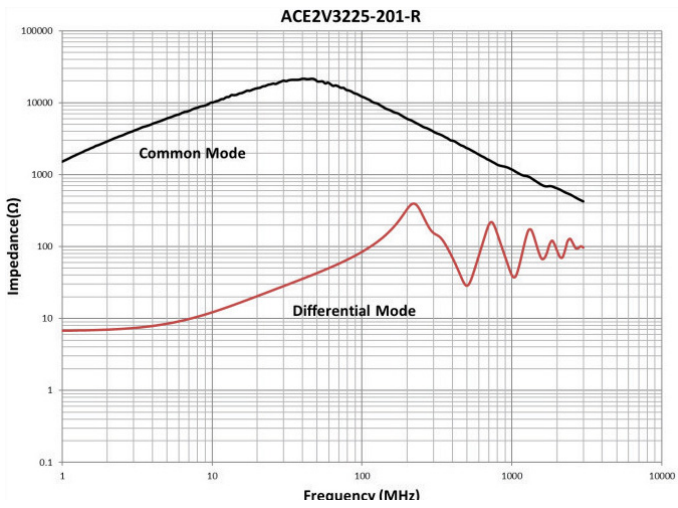
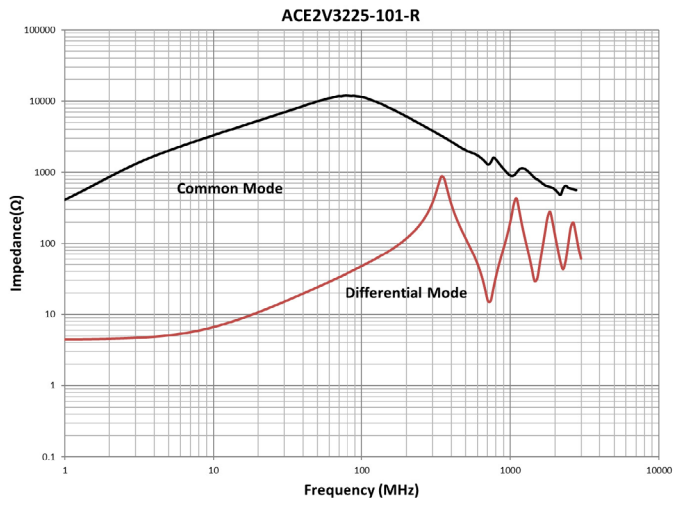

Solder reflow profile

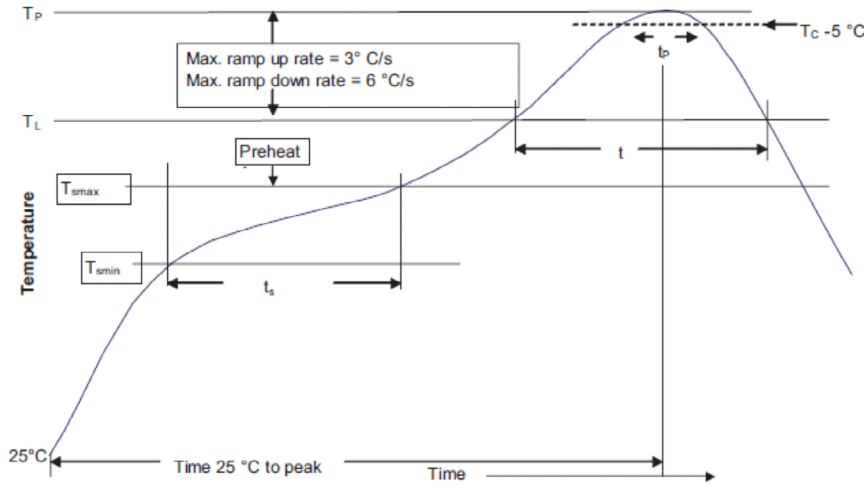

Table 1 - Standard SnPb solder (T_C)

Package thickness	Volume mm ³ <350	Volume mm ³ ≥350
<2.5 mm)	235 °C	220 °C
≥2.5 mm	220 °C	220 °C

Table 2 - Lead (Pb) free solder (T_C)

Package thickness	Volume mm ³ <350	Volume mm ³ 350 - 2000	Volume mm ³ >2000
<1.6 mm	260 °C	260 °C	260 °C
1.6 – 2.5 mm	260 °C	250 °C	245 °C
>2.5 mm	250 °C	245 °C	245 °C

Reference J-STD-020

Profile feature	Standard SnPb solder	Lead (Pb) free solder
Preheat and soak		
• Temperature min. (T_{smin})	100 °C	150 °C
• Temperature max. (T_{smax})	150 °C	200 °C
• Time (T_{smin} to T_{smax}) (t_s)	60-120 seconds	60-120 seconds
Ramp up rate T_L to T_p	3 °C/ second max.	3 °C/ second max.
Liquidous temperature (T_L)	183 °C	217 °C
Time (t_L) maintained above T_L	60-150 seconds	60-150 seconds
Peak package body temperature (T_p)*	Table 1	Table 2
Time (t_p)* within 5 °C of the specified classification temperature (T_C)	20 seconds*	30 seconds*
Ramp-down rate (T_p to T_L)	6 °C/ second max.	6 °C/ second max.
Time 25 °C to peak temperature	6 minutes max.	8 minutes max.

* Tolerance for peak profile temperature (T_p) is defined as a supplier minimum and a user maximum.

Life Support Policy: Eaton does not authorize the use of any of its products for use in life support devices or systems without the express written approval of an officer of the Company. Life support systems are devices which support or sustain life, and whose failure to perform, when properly used in accordance with instructions for use provided in the labeling, can be reasonably expected to result in significant injury to the user.

Eaton reserves the right, without notice, to change design or construction of any products and to discontinue or limit distribution of any products. Eaton also reserves the right to change or update, without notice, any technical information contained in this bulletin.

Eaton
Electronics Division
1000 Eaton Boulevard
Cleveland, OH 44122
United States
Eaton.com/electronics

© 2022 Eaton
All Rights Reserved
Printed in USA
Publication No. ELX1211
October 2022

Eaton is a registered trademark.

All other trademarks are property of their respective owners.

Follow us on social media to get the latest product and support information.

