



MP2172C

5.5V, 2A, Sync Step-Down Converter with Output Discharge in UTQFN Package

DESCRIPTION

The MP2172C is a monolithic, step-down, switch-mode converter with built-in internal power MOSFETs. It achieves 2A of continuous output current from a 2.38V to 5.5V input voltage range with excellent load and line regulation. The output voltage can be regulated as low as 0.6V.

The constant-on-time (COT) control scheme provides fast transient response and eases loop stabilization. Fault protections include cycle-by-cycle current limiting and thermal shutdown.

The MP2172C is ideal for a wide range of applications, including high-performance DSPs, wireless power, portable and mobile devices, and other low-power systems.

The MP2172C requires a minimal number of readily available, standard external components, and is available in ultra-small 1.2mmx1.6mm UTQFN packages.

FEATURES

- Fixed-Frequency PWM Mode
- 1.1MHz Switching Frequency
- EN for Power Sequencing
- 1% FB Accuracy
- Wide 2.38V to 5.5V Operating Input Range
- Output Adjustable from 0.6V
- Up to 2A Output Current
- 75mΩ and 45mΩ Internal Power MOSFET Switches
- 100% Duty On
- Output Discharge
- V_{OUT} Over-Voltage Protection (OVP)
- Short-Circuit Protection (SCP) with Hiccup Mode
- Available in a UTQFN (1.2mmx1.6mm) Package

APPLICATIONS

- Wireless/Networking Cards
- Portable Instruments
- Battery-Powered Devices
- Low-Voltage I/O System Power
- Multi-Function Printers
- Solid-State Drives

All MPS parts are lead-free, halogen-free, and adhere to the RoHS directive. For MPS green status, please visit the MPS website under Quality Assurance. "MPS", the MPS logo, and "Simple, Easy Solutions" are registered trademarks of Monolithic Power Systems, Inc. or its subsidiaries.

TYPICAL APPLICATION

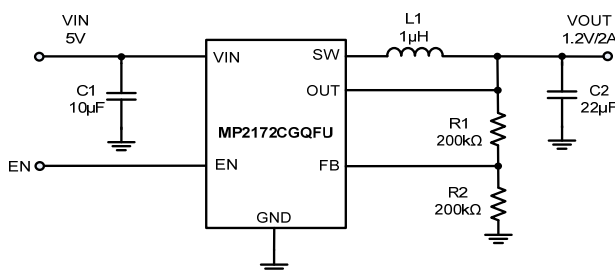

Efficiency vs. Output Current

V_{IN}=5V, L=1µH (DCR=27mΩ)

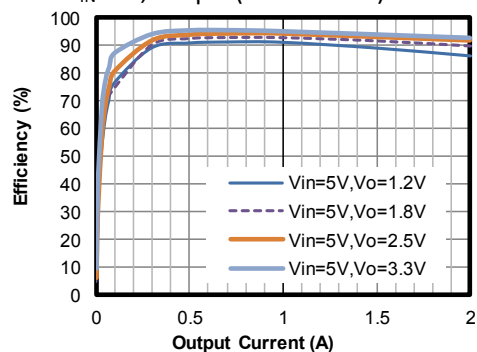

ORDERING INFORMATION

Part Number*	Package	Top Marking
MP2172CGQFU	UTQFN-6 (1.2mmx1.6mm)	See Below

* For Tape & Reel, add suffix –Z (e.g. MP2172CGQFU–Z).

TOP MARKING

—
HU
LL

HU: Product code of MP2172CGQFU
 LL: Lot number

PACKAGE REFERENCE

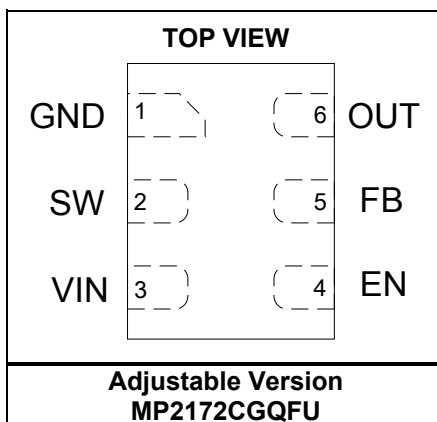

ABSOLUTE MAXIMUM RATINGS ⁽¹⁾

Supply voltage (V_{IN})	6.5V
V_{SW}	-0.3V (-5V for <10ns) to 6.5V (10V for <10ns)
All other pins	-0.3V to 6.5 V
Junction temperature	150°C
Lead temperature	260°C
Continuous power dissipation ($T_A = +25^\circ\text{C}$)	
UTQFN	2W ⁽²⁾ ⁽⁴⁾
Storage temperature	-65°C to +150°C

Recommended Operating Conditions ⁽³⁾

Supply voltage (V_{IN})	2.38V to 5.5V
Operating junction temp (T_J)	-40°C to +125°C

<i>Thermal Resistance</i>	θ_{JA}	θ_{JC}
UTQFN (1.2mmx1.6mm)		
EV2172C-QFU-00A ⁽⁴⁾	65	30 ... °C/W
JESD51-7 ⁽⁵⁾	173	127 .. °C/W

Notes:

- 1) Exceeding these ratings may damage the device.
- 2) The maximum allowable power dissipation is a function of the maximum junction temperature T_J (MAX), the junction-to-ambient thermal resistance θ_{JA} , and the ambient temperature T_A . The maximum allowable continuous power dissipation at any ambient temperature is calculated by P_D (MAX) = $(T_J$ (MAX) - T_A) / θ_{JA} . Exceeding the maximum allowable power dissipation produces an excessive die temperature, causing the regulator to go into thermal shutdown. Internal thermal shutdown circuitry protects the device from permanent damage.
- 3) The device is not guaranteed to function outside of its operating conditions.
- 4) Measured on EV2172C-Q-00A demo board, 2-layer PCB.
- 5) Measured on JESD51-7, 4-layer PCB.
note 5) The value of θ_{JA} given in this table is only valid for comparison with other packages and cannot be used for design purposes. These values are calculated in accordance with JESD51-7, and simulated on a specified JEDEC board. They do not represent the performance obtained in an actual application.

ELECTRICAL CHARACTERISTICS

$V_{IN} = 3.6V$, $T_J = -40^{\circ}C$ to $+125^{\circ}C$ ⁽⁶⁾, typical value is tested at $T_J = +25^{\circ}C$. Over-temperature limit is guaranteed by characterization, unless otherwise noted.

Parameter	Symbol	Condition	Min	Typ	Max	Units
V_{IN} range			2.38		5.5	V
Under-voltage lockout threshold rising				2.3	2.38	V
Under-voltage lockout threshold falling					2.25	V
Under-voltage lockout threshold hysteresis				200		mV
Feedback voltage	V_{FB}	$T_J = 25^{\circ}C$	594	600	606	mV
		$T_J = -40^{\circ}C$ to $+125^{\circ}C$	591	600	609	
Feedback current	I_{FB}	$V_{FB} = 0.63V$		50	100	nA
P-FET switch on resistance	R_{DSON_P}	$V_{IN} = 5V$		75		m Ω
N-FET switch on resistance	R_{DSON_N}	$V_{IN} = 5V$		45		m Ω
Switch leakage		$V_{EN} = 0V$, $V_{IN} = 6V$, $V_{SW} = 0V$ and $6V$, $T_J = +25^{\circ}C$		0	1	μA
P-FET peak current limit			2.8		4	A
N-FET valley current limit				2.5		A
On time	t_{ON}	$V_{IN} = 5V$, $V_{OUT} = 1.2V$	180	220	260	ns
		$V_{IN} = 3.6V$, $V_{OUT} = 1.2V$	240	300	360	
Switching frequency	f_s	$V_{OUT} = 1.2V$		1100		kHz
Minimum off time	$t_{MIN-OFF}$			100		ns
Minimum on time ⁽⁷⁾	t_{MIN-ON}			60		ns
Soft-start time	t_{SS-ON}	V_{OUT} rise from 10% to 90%		0.5		ms
Maximum duty cycle			100			%

ELECTRICAL CHARACTERISTICS (continued)

$V_{IN} = 3.6V$, $T_J = -40^{\circ}C$ to $+125^{\circ}C$ ⁽⁶⁾, typical value is tested at $T_J = +25^{\circ}C$. Over-temperature limit is guaranteed by characterization, unless otherwise noted.

Parameter	Symbol	Condition	Min	Typ	Max	Units
EN turn-on delay		EN on to SW active		150		μs
EN input logic low voltage					0.4	V
EN input logic high voltage			1.2			V
Output discharge resistor	RDIS	$V_{EN} = 0V$, $V_{OUT} = 1.2V$		200		Ω
EN input current		$V_{EN} = 2V$		1.2		μA
		$V_{EN} = 0V$		0		μA
Supply current (shutdown)		$V_{EN} = 0V$, $T_J = +25^{\circ}C$		0	1	μA
Supply current (quiescent)		$V_{EN} = 2V$, $V_{FB} = 0.63V$, $V_{IN} = 5V$, $T_J = +25^{\circ}C$		450		μA
Output over-voltage threshold	VOVP		110%	115%	120%	V_{FB}
V_{OUT} OVP hysteresis	VOVP_HYS			10%		V_{FB}
OVP delay				12		μs
Low-side current		Current flow from SW to GND		1.5		A
Absolute V_{IN} OVP		After V_{OUT} OVP enables		6.1		V
Absolute V_{IN} OVP hysteresis				400		mV
Thermal shutdown ⁽⁷⁾				160		$^{\circ}C$
Thermal hysteresis ⁽⁷⁾				30		$^{\circ}C$

Notes:

- 6) Guaranteed by over-temperature correlation, not tested in production.
 7) Guaranteed by engineering sample characterization.

TYPICAL CHARACTERISTICS

$V_{IN} = 3.6V$, $V_{OUT} = 1.2V$, $L = 1\mu H$, $C_{OUT} = 22\mu F$, $T_A = +25^\circ C$, unless otherwise noted.

Quiescent Current vs. Input Voltage

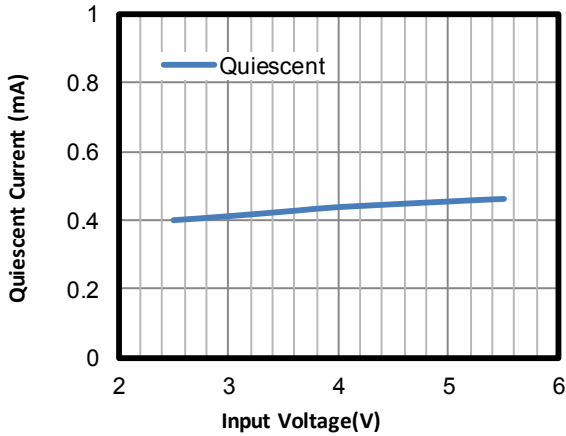

Shutdown Current vs. Input Voltage

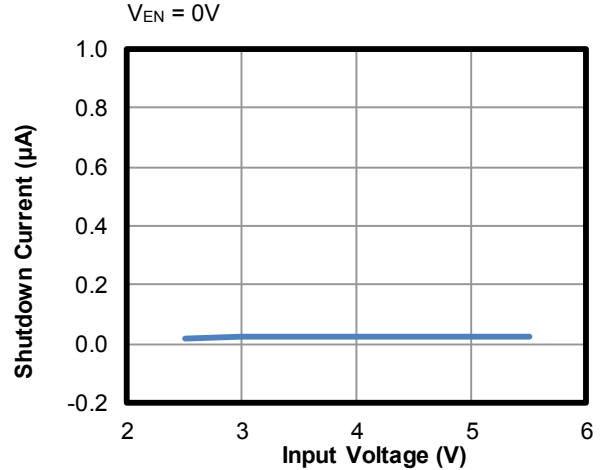

Load Regulation vs. Output Current

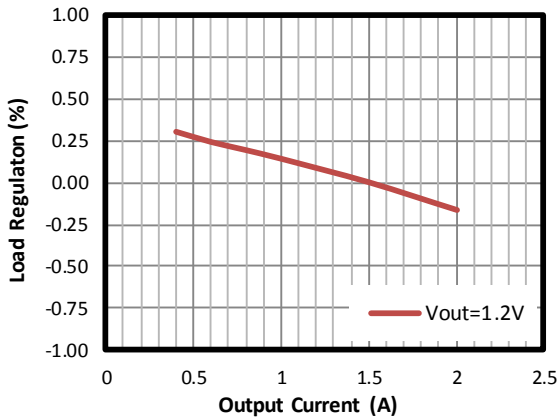

Line Regulation vs. Output Current

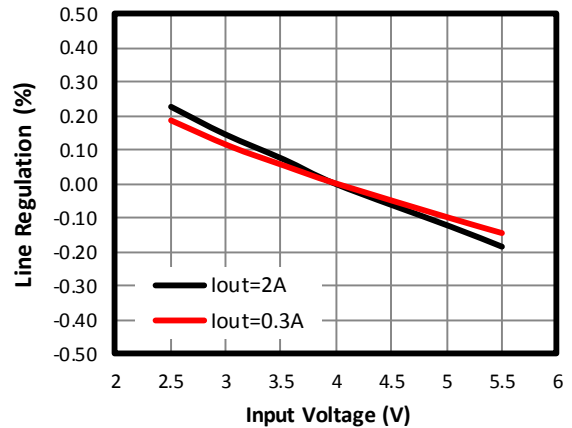

T_{RISING} vs. Output Current

$V_{IN} = 5V$

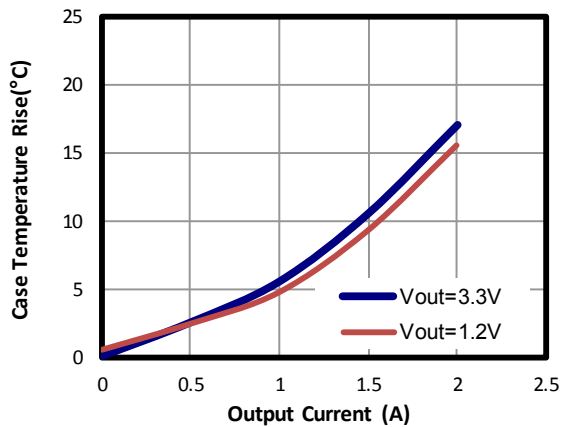

Efficiency vs. Output Current

$V_{IN} = 5V$, $L = 1\mu H$ (DCR=27mΩ)

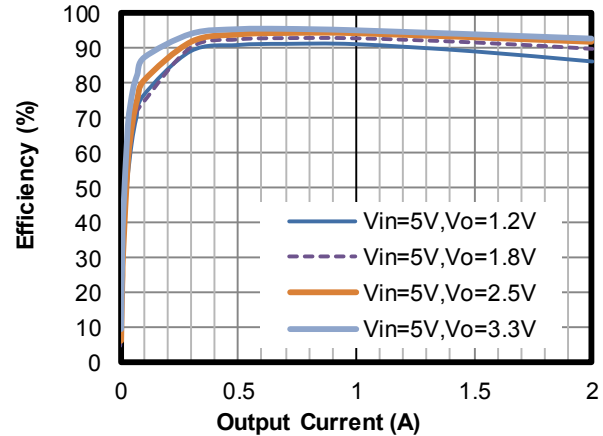

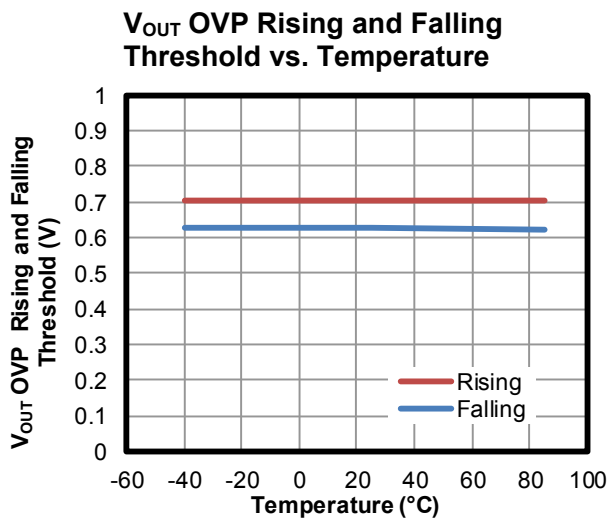
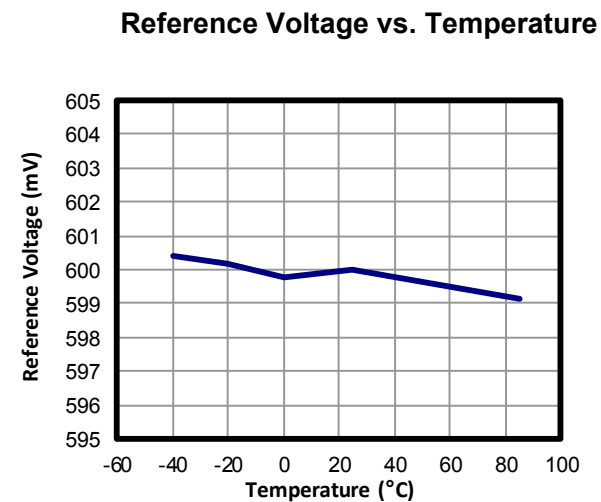
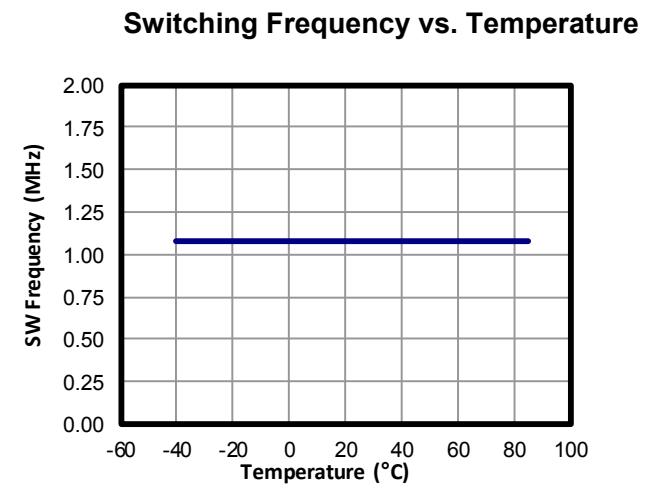
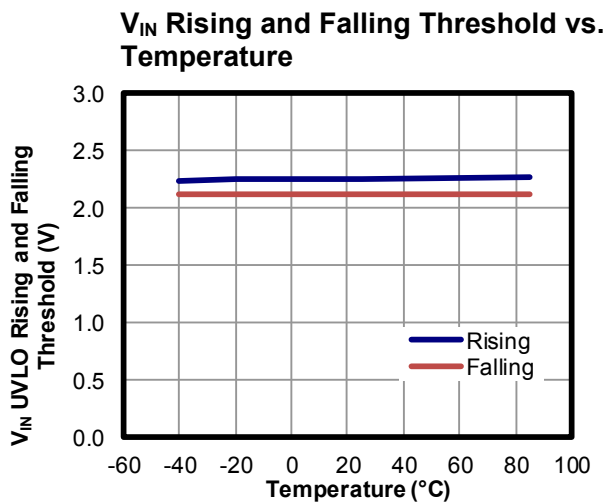
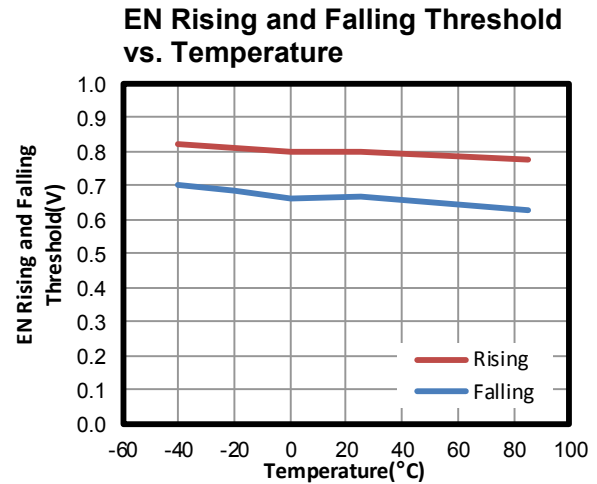
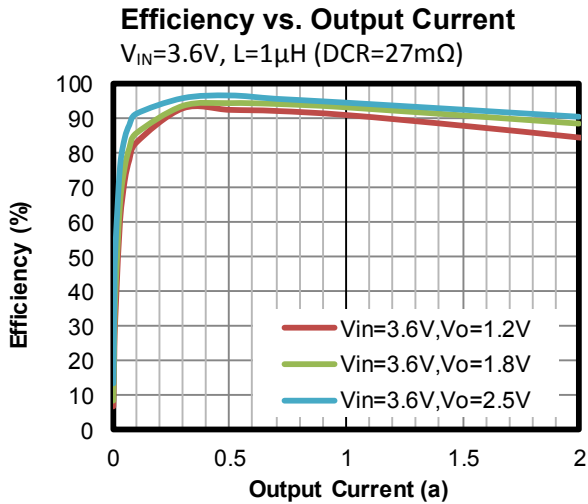
TYPICAL CHARACTERISTICS (continued)
 $V_{IN} = 3.6V$, $V_{OUT} = 1.2V$, $L = 1\mu H$, $C_{OUT} = 22\mu F$, $T_A = +25^\circ C$, unless otherwise noted.

TYPICAL CHARACTERISTICS *(continued)*

$V_{IN} = 3.6V$, $V_{OUT} = 1.2V$, $L = 1\mu H$, $C_{OUT} = 22\mu F$, $T_A = +25^\circ C$, unless otherwise noted.

V_{IN} OVP Rising and Falling Threshold vs. Temperature

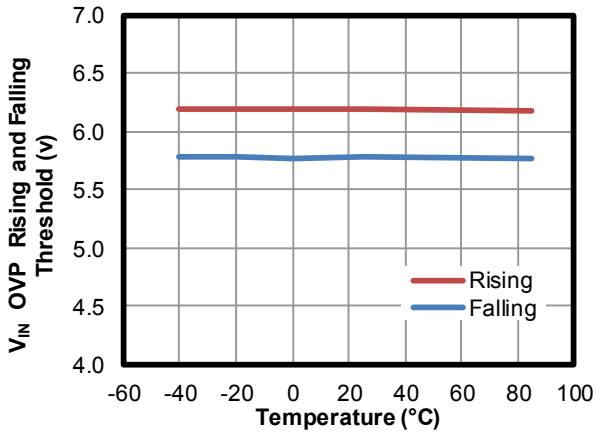

Output Current Derating vs. Ambient Temperature
 $T_J \leq 125^\circ C$

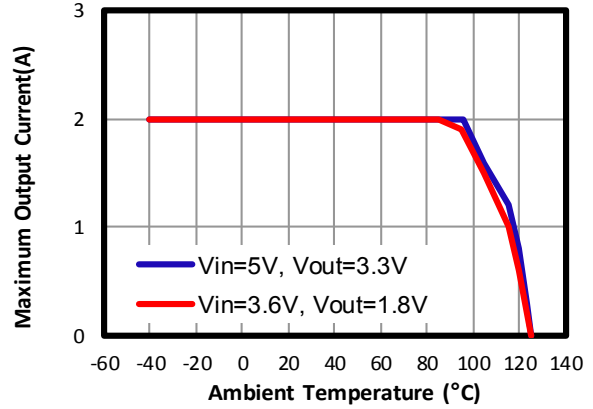

Output Current Derating vs. Output Voltage
 $T_J \leq 125^\circ C$

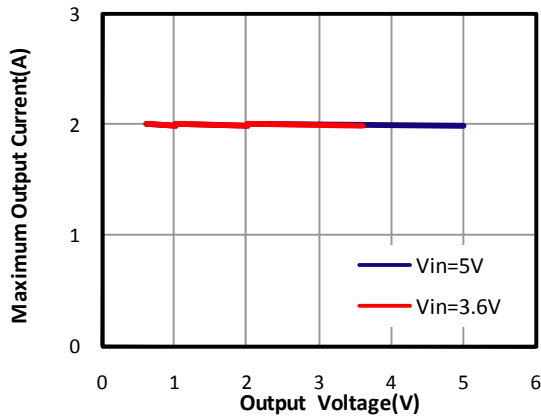

TYPICAL PERFORMANCE CHARACTERISTICS

$V_{IN} = 5V$, $V_{OUT} = 1.2V$, $L = 1\mu H$, $C_{OUT} = 22\mu F$, $T_A = +25^\circ C$, unless otherwise noted.

Steady State

$I_{OUT} = 0A$

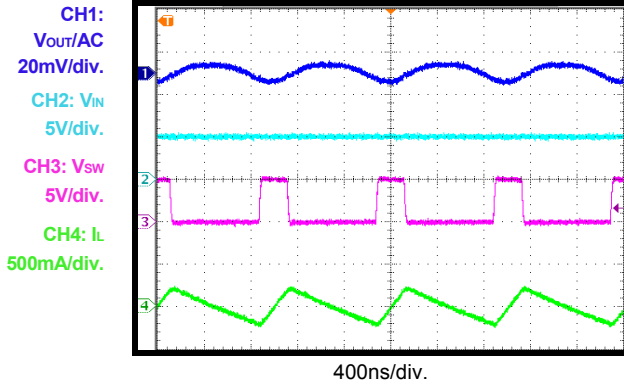

Steady State

$I_{OUT} = 2A$

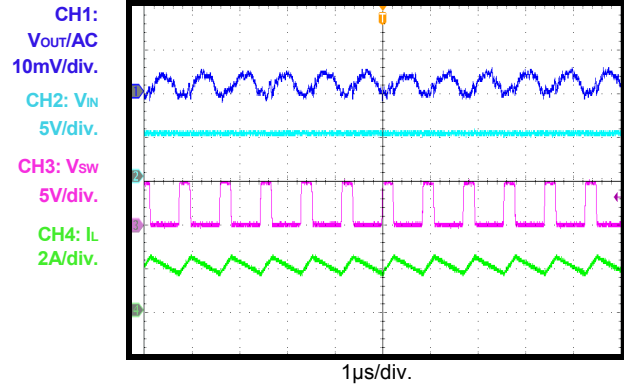

V_{IN} Power-Up

$I_{OUT} = 0A$

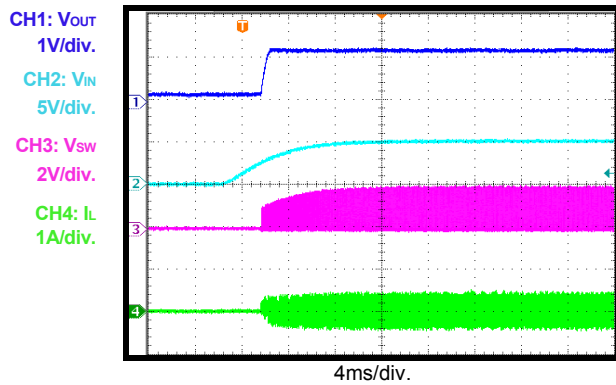

V_{IN} Power-Up

$I_{OUT} = 2A$

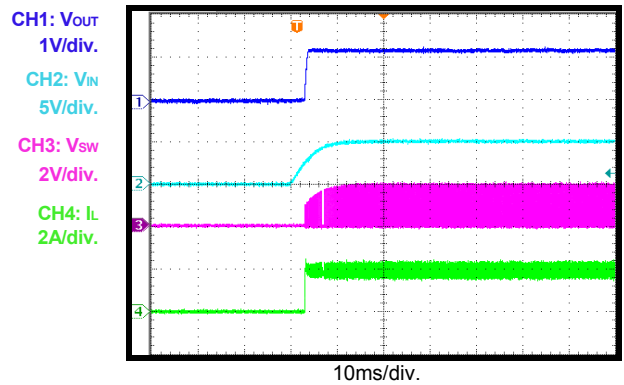

V_{IN} Shutdown

$I_{OUT} = 0A$

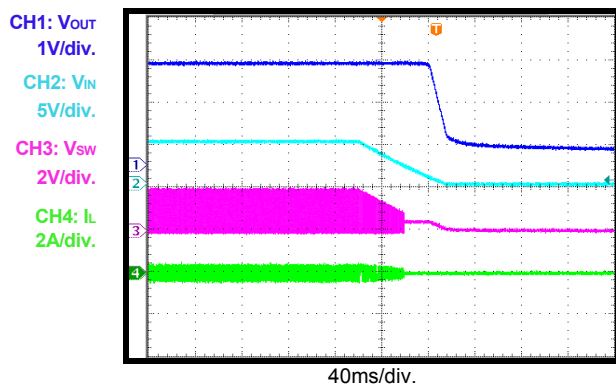

V_{IN} Shutdown

$I_{OUT} = 2A$

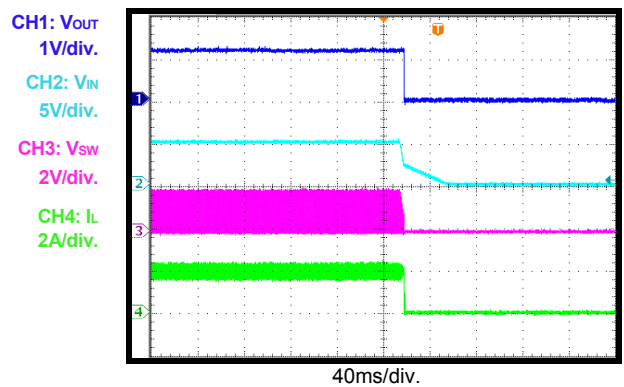

TYPICAL PERFORMANCE CHARACTERISTICS (continued)
 $V_{IN} = 5V$, $V_{OUT} = 1.2V$, $L = 1\mu H$, $C_{OUT} = 22\mu F$, $T_A = +25^\circ C$, unless otherwise noted.

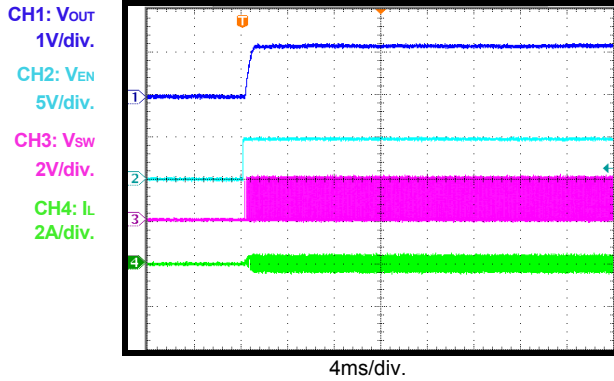
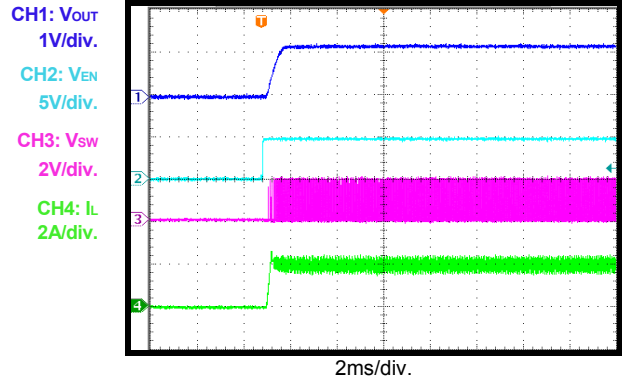
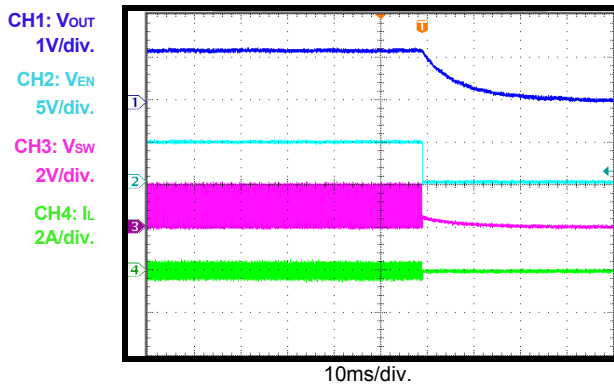
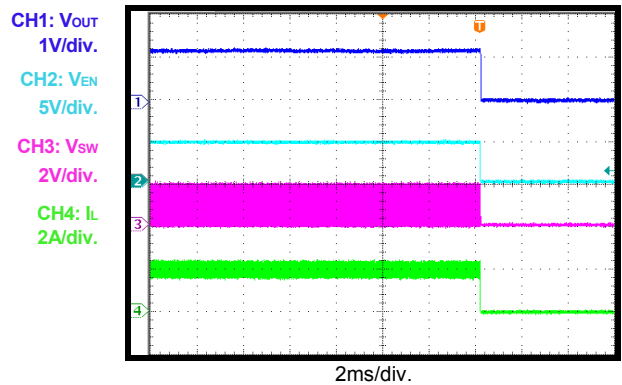
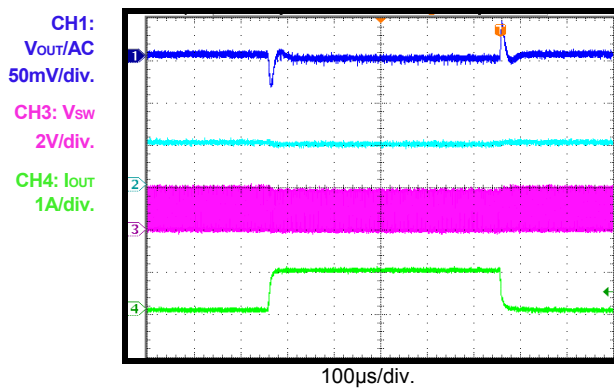
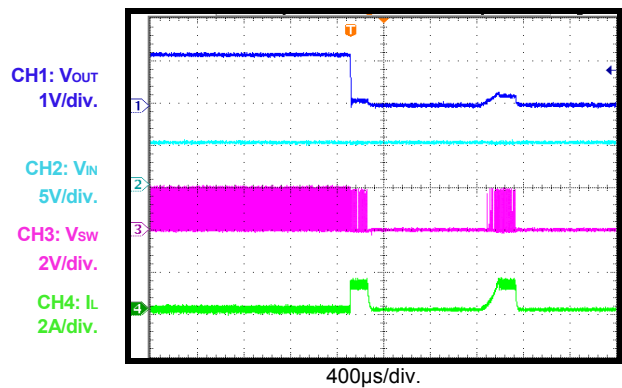
EN Power-Up
 $I_{OUT} = 0A$

EN Power-Up
 $I_{OUT} = 2A$

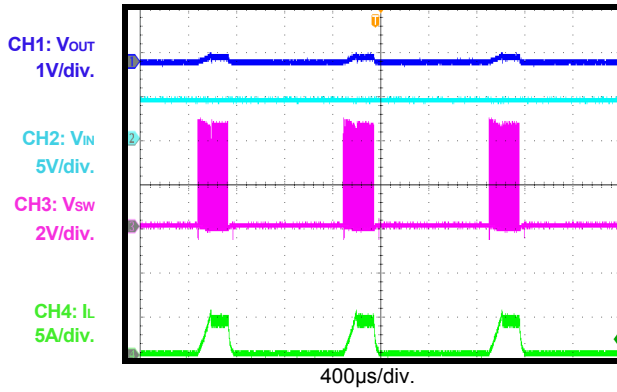
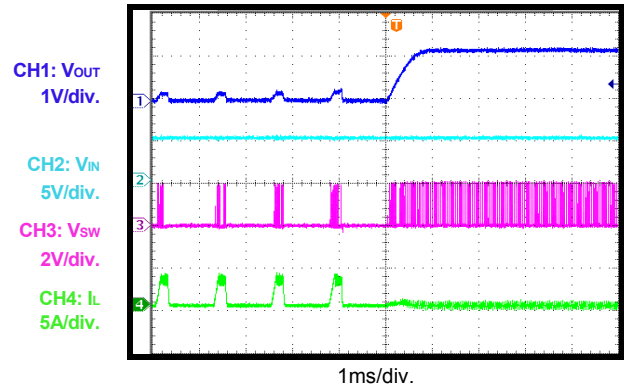
EN Shutdown
 $I_{OUT} = 0A$

EN Shutdown
 $I_{OUT} = 2A$

Load Transient
 $I_{OUT} = 0A$ to $5A$

Short-Circuit Entry

TYPICAL PERFORMANCE CHARACTERISTICS (continued)
 $V_{IN} = 5V$, $V_{OUT} = 1.2V$, $L = 1\mu H$, $C_{OUT} = 22\mu F$, $T_A = +25^\circ C$, unless otherwise noted.

Short-Circuit State

Short-Circuit Recovery

PIN FUNCTIONS

Pin #	Name	Description
	UTQFN	
1	GND	Power ground.
2	SW	Output switching node. SW is the drain of the internal high-side P-channel MOSFET. Connect the inductor to SW to complete the converter.
3	VIN	Supply voltage. The MP2172C operates from a +2.38V to +5.5V unregulated input. A decoupling capacitor is needed to prevent large voltage spikes from appearing at the input.
4	EN	On/off control.
5	FB	Feedback. An external resistor divider from the output to GND taped to FB sets the output voltage.
6	OUT	Output sense. OUT is the voltage power rail and input sense for the output voltage. Connect the load to OUT. An output capacitor is needed to decrease the output voltage ripple.

FUNCTIONAL BLOCK DIAGRAM

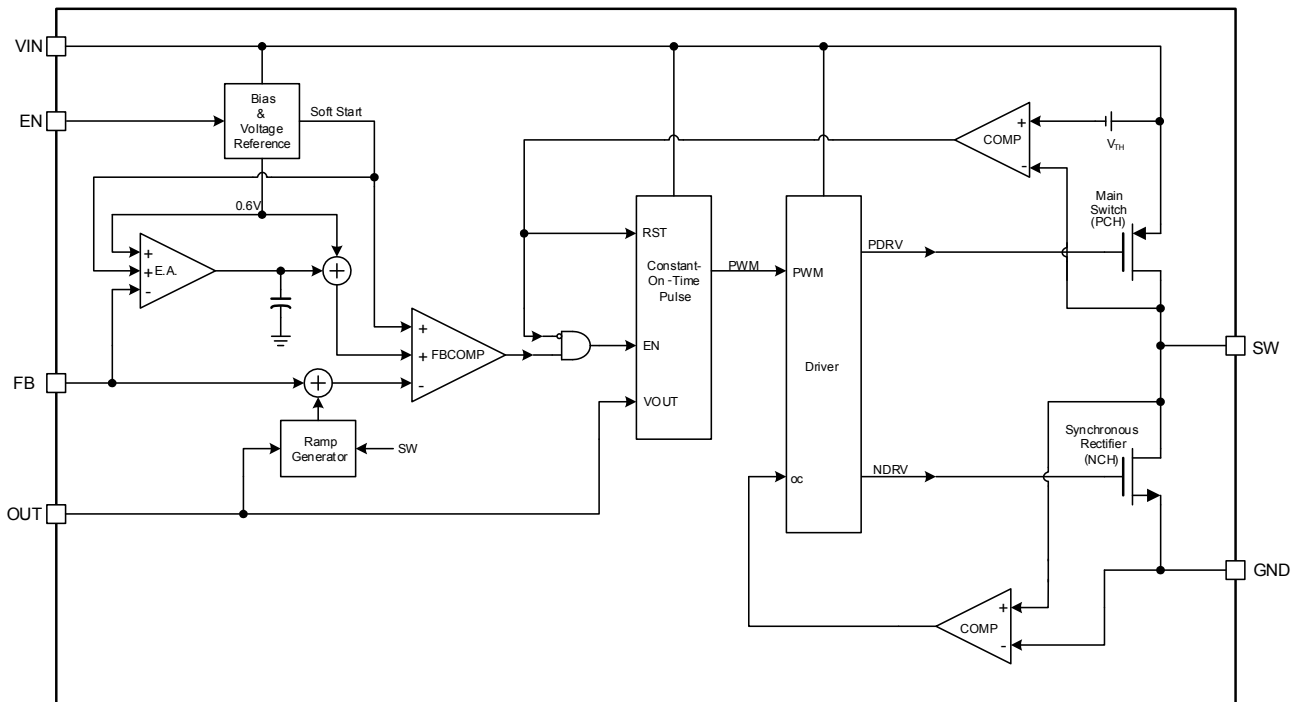

Figure 1: Functional Block Diagram

OPERATION

The MP2172C uses constant-on-time (COT) control with input voltage feed-forward to stabilize the switching frequency over the entire input range. The part achieves 2A of continuous output current from a 2.38V to 5.5V input voltage range with excellent load and line regulation. The output voltage can be regulated as low as 0.6V.

Constant-On-Time (COT) Control

Constant-on-time (COT) control offers a simpler control loop and faster transient response than fixed-frequency pulse-width modulation (PWM) control. By using input voltage feed-forward, the MP2172C maintains a nearly constant switching frequency across the input and output voltage ranges. The switching pulse on time can be estimated with Equation (1):

$$t_{\text{ON}} = \frac{V_{\text{OUT}}}{V_{\text{IN}}} \cdot 0.91 \mu\text{s} \quad (1)$$

To prevent inductor current runaway during the load transient, the MP2172C has a fixed minimum off time of 100ns.

Force PWM Operation

The MP2172C works in continuous current mode (CCM) to achieve a smaller V_{O} ripple, load regulation, and load transient in full-load range.

Enable (EN)

If the input voltage is greater than the under-voltage lockout (UVLO) threshold (typically 2.3V), the MP2172C can be enabled by pulling EN higher than 1.2V. Leave EN floating or pull EN down to ground to disable the MP2172C. There is an internal 1M Ω resistor from EN to ground.

When the device is disabled, the MP2172C enters output discharge mode automatically. Its internal discharge MOSFET provides a resistive discharge path for the output capacitor.

Soft Start (SS)

The MP2172C has a built-in soft start that ramps up the output voltage at a controlled slew rate to avoid overshooting at start-up. The soft-start time is typically about 0.5ms.

Current Limit

The MP2172C has a typical minimum 2.8A high-side switch current limit. When the high-side switch reaches its current limit, the MP2172C remains in hiccup mode until the current drops. This prevents the inductor current from continuing to rise and damaging components.

Short Circuit and Recovery

The MP2172C enters short-circuit protection (SCP) mode when it reaches its current limit, and attempts to recover with hiccup mode. The part disables the output power stage, discharges the soft-start capacitor, and attempts to soft start again automatically. If the short-circuit condition remains after the soft start ends, the MP2172C repeats this cycle until the short circuit is removed and the output rises back to the regulation level.

Over-Voltage Protection (OVP)

The MP2172C monitors the feedback voltage to detect over-voltage. When the feedback voltage (V_{FB}) exceeds 115% of the target voltage, the controller enters a dynamic regulation period. During this period, the low-side MOSFET (LS-FET) turns on until the low-side current drops to -1.5A. This discharges the output to keep it within the normal range. If the over-voltage condition still remains, the LS-FET turns on again after a 1 μs delay. The MP2172C exits this regulation period when V_{FB} falls below 105% of the reference voltage. If the dynamic regulation cannot limit the increasing V_{OUT} , once the input detects the 6.1V input, over-voltage protection (OVP) occurs. The MP2172C stops switching until the input voltage drops below 5.7V, and then the part resumes operation.

APPLICATION INFORMATION

Setting the Output Voltage

The external resistor divider sets the output voltage (see the Typical Application section on page 17). Select a feedback resistor (R1) value to reduce the V_{OUT} leakage current, typically between 100k Ω and 200k Ω . There is no strict requirement on the feedback resistor. An R1 value greater than 10k Ω is reasonable for applications. R2 can then be calculated with Equation (2):

$$R2 = \frac{R1}{\frac{V_{OUT}}{0.6} - 1} \quad (2)$$

Figure 9 shows the feedback circuit.

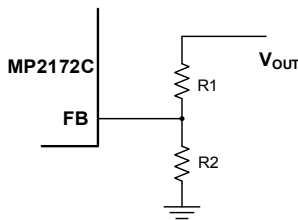

Figure 9: Feedback Network

Table 1 lists the recommended resistor values for common output voltages.

Table 1: Resistor Values for Common Output Voltages

V_{OUT} (V)	R1 (k Ω)	R2 (k Ω)
1.0	200 (1%)	300 (1%)
1.2	200 (1%)	200 (1%)
1.8	200 (1%)	100 (1%)
2.5	200 (1%)	63.2 (1%)
3.3	200 (1%)	44.2 (1%)

Selecting the Inductor

Most applications work best with a 1 μ H to 2.2 μ H inductor. Select an inductor with a DC resistance less than 50m Ω to optimize efficiency.

A high-frequency, switch-mode power supply with a magnetic device has strong electronic magnetic interference (EMI). Any unshielded power inductors should be avoided. Metal alloy or multi-layer chip power inductors are ideal shielded inductors since they decrease interference effectively.

Table 2 lists some recommended inductors.

Table 2: Suggested Inductor List

Manufacturer P/N	Inductance (μ H)	Manufacturer
PIFE25201B-1R0MS	1.0	CYNTEC CO. LTD.
74437324010	1.0	Würth

For most designs, estimate the inductance value with Equation (3):

$$L_1 = \frac{V_{OUT} \times (V_{IN} - V_{OUT})}{V_{IN} \times \Delta I_L \times f_{OSC}} \quad (3)$$

Where ΔI_L is the inductor ripple current.

Choose the inductor current to be approximately 30% of the maximum load current. The maximum inductor peak current can be calculated with Equation (4):

$$I_{L(MAX)} = I_{LOAD} + \frac{\Delta I_L}{2} \quad (4)$$

Selecting the Input Capacitor

The step-down converter has a discontinuous input current, and requires a capacitor to supply AC current to the converter while maintaining the DC input voltage. Use low-ESR capacitors for the best performance. Ceramic capacitors with X5R or X7R dielectrics are highly recommended because of their low ESR and small temperature coefficients. For most applications, a 22 μ F capacitor is sufficient. Higher output voltages may require a 44 μ F capacitor to increase system stability.

The input capacitor requires an adequate ripple current rating since it absorbs the input switching current. Estimate the RMS current in the input capacitor with Equation (5):

$$I_{C1} = I_{LOAD} \times \sqrt{\frac{V_{OUT}}{V_{IN}} \times \left(1 - \frac{V_{OUT}}{V_{IN}}\right)} \quad (5)$$

The worst-case scenario occurs at $V_{IN} = 2V_{OUT}$, calculated with Equation (6):

$$I_{C1} = \frac{I_{LOAD}}{2} \quad (6)$$

For simplification, choose an input capacitor with an RMS current rating greater than half of the maximum load current. The input capacitor can be electrolytic, tantalum, or ceramic. When using electrolytic or tantalum capacitors, add a small, high-quality 0.1µF ceramic capacitor as close to the IC as possible. When using ceramic capacitors, ensure that they have enough capacitance to provide a sufficient charge to prevent excessive voltage ripple at the input. The input voltage ripple caused by the capacitance can be estimated with Equation (7):

$$\Delta V_{IN} = \frac{I_{LOAD}}{f_s \times C1} \times \frac{V_{OUT}}{V_{IN}} \times \left(1 - \frac{V_{OUT}}{V_{IN}}\right) \quad (7)$$

Selecting the Output Capacitor

The output capacitor (C2) stabilizes the DC output voltage. Low ESR ceramic capacitors are recommended to limit the output voltage ripple. Estimate the output voltage ripple with Equation (8):

$$\Delta V_{OUT} = \frac{V_{OUT}}{f_s \times L_1} \times \left(1 - \frac{V_{OUT}}{V_{IN}}\right) \times \left(R_{ESR} + \frac{1}{8 \times f_s \times C2}\right) \quad (8)$$

Where L_1 is the inductor value, and R_{ESR} is the equivalent series resistance (ESR) value of the output capacitor.

When using ceramic capacitors, the capacitance dominates the impedance at the switching frequency and causes most of the output voltage ripple. For simplification, the output voltage ripple can be estimated with Equation (9):

$$\Delta V_{OUT} = \frac{V_{OUT}}{8 \times f_s^2 \times L_1 \times C2} \times \left(1 - \frac{V_{OUT}}{V_{IN}}\right) \quad (9)$$

For tantalum or electrolytic capacitors, the ESR dominates the impedance at the switching frequency. For simplification, the output ripple can be approximated with Equation (10):

$$\Delta V_{OUT} = \frac{V_{OUT}}{f_s \times L_1} \times \left(1 - \frac{V_{OUT}}{V_{IN}}\right) \times R_{ESR} \quad (10)$$

The characteristics of the output capacitor also affect the stability of the regulation system.

PCB Layout Guidelines

Efficient PCB layout is critical for stable operation. For the high-frequency switching converter, improper layout design can result in poor line or load regulation and stability issues. For best results, refer to Figure 10 and follow the guidelines below:

1. Place the high-current paths (GND, VIN, and SW) very close to the device with short, direct, and wide traces.
2. Place the input capacitor as close to VIN and GND as possible.
3. Place the external feedback resistors next to FB.
4. Keep SW short and away from the feedback network.
5. Keep the V_{OUT} sense line need as short as possible and away from the power inductor, especially the surrounding inductor.

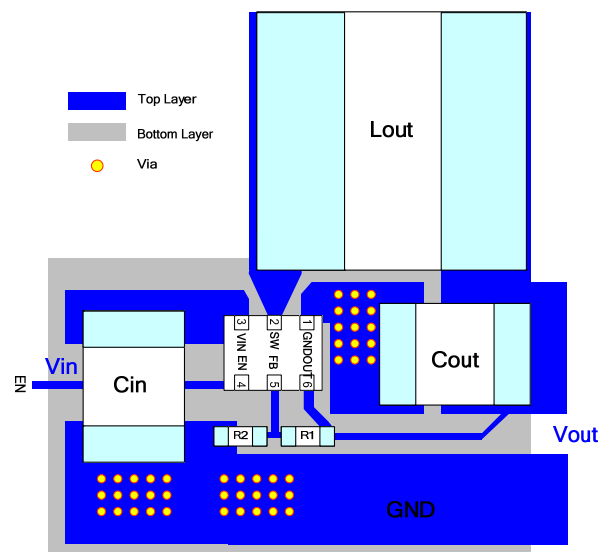
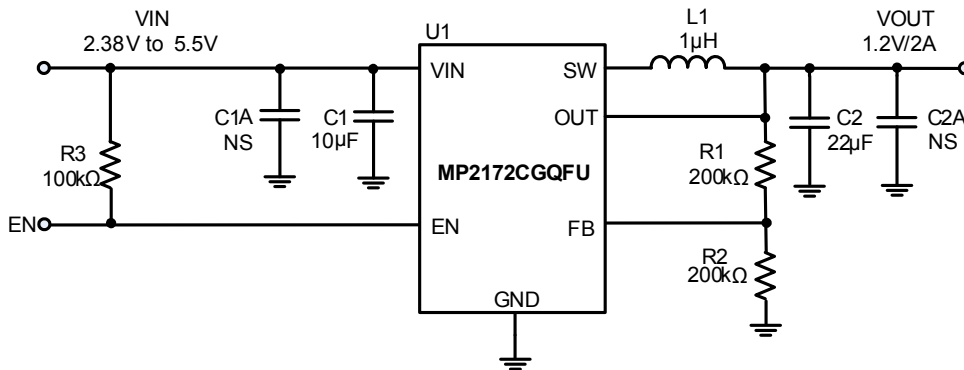

Figure 10: Recommended Layout for the MP2172C

TYPICAL APPLICATION CIRCUITS

Figure 11: Typical Application Circuit for the MP2172C

Note: $V_{IN} < 3.3V$ may require more input capacitors.

PACKAGE INFORMATION

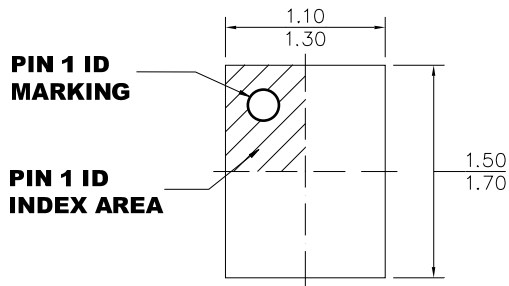
UTQFN (1.2mmx1.6mm)



TOP VIEW

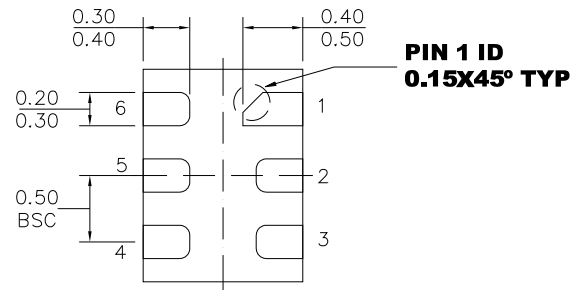

BOTTOM VIEW

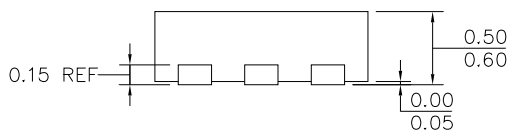

SIDE VIEW

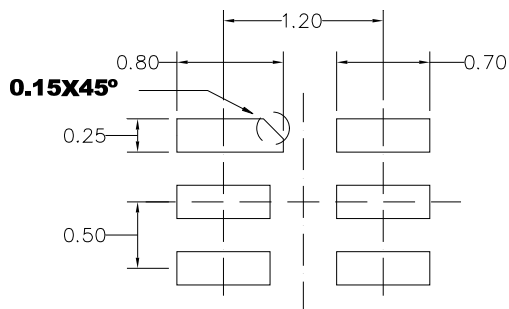

RECOMMENDED LAND PATTERN

NOTE:

- 1) ALL DIMENSIONS ARE IN MILLIMETERS.
- 2) LEAD COPLANARITY SHALL BE 0.08 MILLIMETERS MAX.
- 3) JEDEC REFERENCE IS MO-220.
- 4) DRAWING IS NOT TO SCALE.

NOTICE: The information in this document is subject to change without notice. Please contact MPS for current specifications. Users should warrant and guarantee that third-party Intellectual Property rights are not infringed upon when integrating MPS products into any application. MPS will not assume any legal responsibility for any said applications.