

APPROVED: _____
 DATE: _____ TITLE: _____

Rev	AWO #	Description	Date	Appr
-		RELEASED	6/6/18	

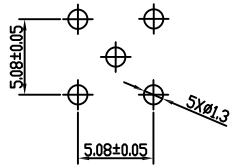

RECOMMENDED P.C.B LAYOUT

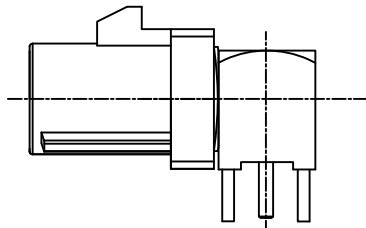
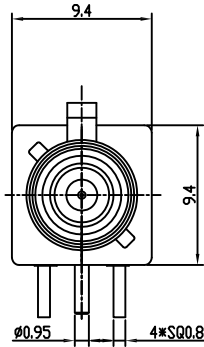
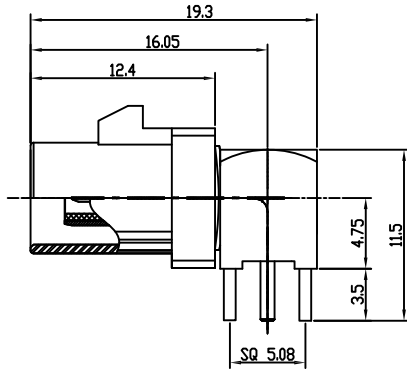
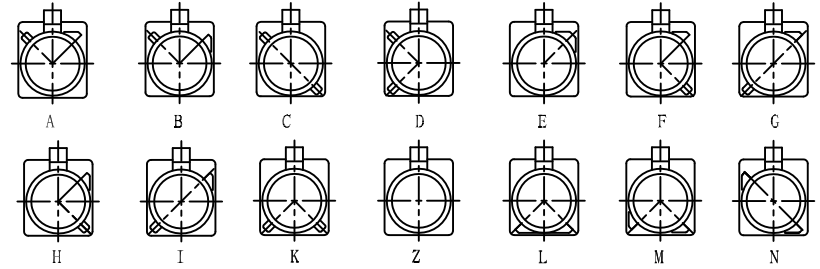

Port Type

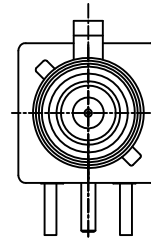

RF55-32X-T-00-50-A-SH

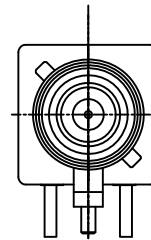

RF55-32X-T-00-50-B-SH

Type	Color	Item No
A	BLACK	RF55-32A-T-00-50-X-SH
B	WHITE	RF55-32B-T-00-50-X-SH
C	BLUE	RF55-32C-T-00-50-X-SH
D	BORDEAUX VIOLET	RF55-32D-T-00-50-X-SH
E	GREEN	RF55-32E-T-00-50-X-SH
F	BROWN	RF55-32F-T-00-50-X-SH
G	GREY	RF55-32G-T-00-50-X-SH
H	VIOLET	RF55-32H-T-00-50-X-SH
I	BEIGE	RF55-32I-T-00-50-X-SH
K	CURRY	RF55-32K-T-00-50-X-SH
Z	WATER BLUE	RF55-32Z-T-00-50-X-SH
L	CARMINE RED	RF55-32L-T-00-50-X-SH
M	PASTEL ORANGE	RF55-32M-T-00-50-X-SH
N	PASTEL GREEN	RF55-32N-T-00-50-X-SH

PLASTIC SHELL	PA66+30%GF	
INSULATOR	LCP	
INSULATOR	PTFE	
PIN CONTACT	PHOSPHOR BRONZE	GOLD
COVER	BRASS	NICKEL
BODY (FRONT)	BRASS	NICKEL
BODY (BACK)	BRASS	FOG TIN
DESCRIPTION	MATERIAL	FINISH

SPECIFICATIONS:

Electrical:
 Frequency range: DC~4 GHz
 Nominal Impedance: 50 ohms
 Withstanding voltage: 335 V
 Insulator Resistance: 1000 MΩ
 Contact Resistance: 6 Milliohms max. (Center Contact)
 1 Milliohms max. (Outer Contact)

Temperature Rating:
 Operating temperature: -40°C to +85°C
 Environmental:
 Lead free, RoHS compliant.



UNLESS OTHERWISE SPECIFIED
 ALL DIMENSIONS ARE MILLIMETERS
 TOLERANCES: EXCEPT AS NOTED
 INCHES HOLES

.X	± 0.25		
.XX	± 0.15	Ø.XX	± 0.13
.XXX	+ 0.05		

APPROVALS		DATE
DRAWN	AY	6/6/18
CHECKED	MY	6/6/18
APPROVED		

ADAM TECH INTERCONNECTS
 909 Rahway Avenue,
 Union, NJ 07083
 Phone: 908-687-5000
 Fax: 908-687-5710

TITLE		
FAKRA PLUG SMB TYPE RIGHT ANGLE, FOR SMT		
SIZE	PART NO.	REV.
X	RF55-32X-T-00-50-X-SH	-
REF: S00134C	SCALE: NTS	SHEET 1 OF 1