



The Future of Analog IC Technology®

# MPQ2171

5.5V, 1A, 2.6MHz,  
Synchronous, Step-Down Converter  
AEC-Q100 Qualified

## DESCRIPTION

The MPQ2171 is a monolithic, step-down, switch-mode converter with integrated, internal, power MOSFETs. The MPQ2171 can achieve up to 1A of continuous output current from a 2.5V to 5.5V input voltage with excellent load and line regulation. The output voltage can be regulated as low as 0.6V.

Constant-on-time (COT) control provides fast transient response and eases loop stabilization. Full protection features include cycle-by-cycle current limiting and thermal shutdown.

The MPQ2171 is ideal for a wide range of applications, including automotive infotainment, clusters, telematics, and portable instruments.

The MPQ2171 requires only a minimal number of readily available, standard, external components and is available in a small TSOT23-8 package.

## FEATURES

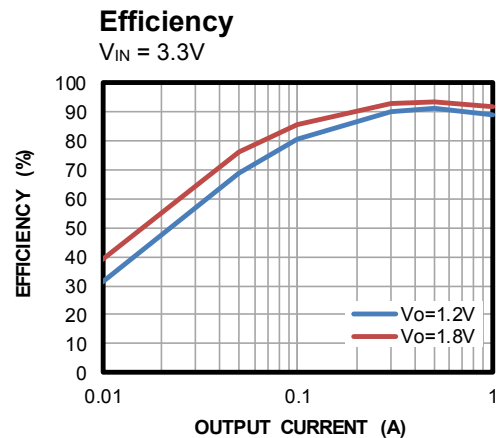
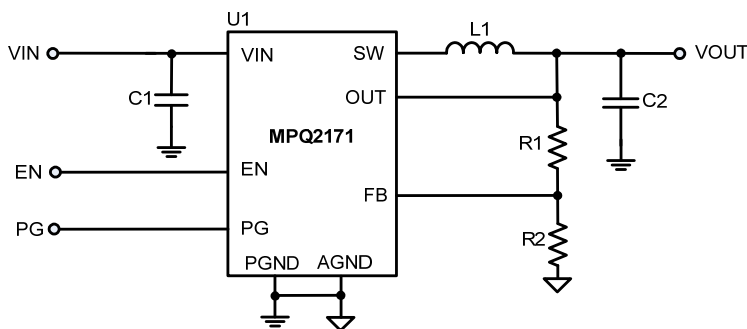
- Wide 2.5V to 5.5V Operating Input Range
- Output Voltage as Low as 0.6V
- 100% Duty Cycle in Dropout
- Up to 1A Output Current
- 90mΩ and 50mΩ Internal Power MOSFET Switches
- Default 2.6MHz Switching Frequency with 3.3V Input and 1.8V Output
- EN and Power Good for Power Sequencing
- Cycle-by-Cycle Over-Current Protection (OCP)
- Auto-Discharge at Power-Off
- Short-Circuit Protection (SCP) with Hiccup Mode
- Stable with Low ESR Output Ceramic Capacitors
- Available in a TSOT23-8 Package
- Available in AEC-Q100 Grade 1

## APPLICATIONS

- Automotive Infotainment
- Automotive Clusters
- Automotive Telematics
- Low-Voltage I/O System Power
- Handheld/Battery-Powered Systems

All MPS parts are lead-free, halogen-free, and adhere to the RoHS directive. For MPS green status, please visit the MPS website under Quality Assurance. "MPS" and "The Future of Analog IC Technology" are registered trademarks of Monolithic Power Systems, Inc.

## TYPICAL APPLICATION



### ORDERING INFORMATION

Part Number *	Package	Top Marking
MPQ2171GJ	TSOT23-8	See Below
MPQ2171GJ-AEC1		

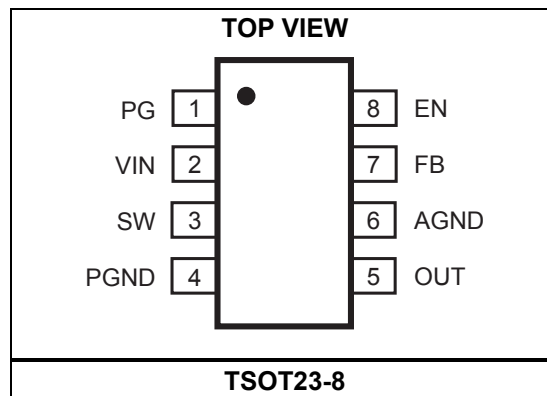
\* For Tape & Reel, add suffix -Z (e.g.: MPQ2171GJ-Z).

### TOP MARKING

**| BAZY**

BAZ: Product code of MPQ2171GJ & MPQ2171GJ-AEC1  
 Y: Year code

### PACKAGE REFERENCE



#### ABSOLUTE MAXIMUM RATINGS <sup>(1)</sup>

Supply voltage ( $V_{IN}$ ) ..... 6V  
 $V_{SW}$  ..... -0.3V (-5V for <10ns)  
 to  $V_{IN} + 0.3V$  (8V for <10ns)  
 All other pins ..... -0.3V to +6V  
 Junction temperature ..... 150°C  
 Lead temperature ..... 260°C  
 Continuous power dissipation ( $T_A = 25^\circ C$ ) <sup>(2)</sup>  
 ..... 1.25W  
 Storage temperature ..... -65°C to +150°C

#### Recommended Operating Conditions <sup>(3)</sup>

Supply voltage ( $V_{IN}$ ) ..... 2.5V to 5.5V  
 Output voltage ( $V_{OUT}$ ) ..... 0.6V to  $V_{IN} - 0.5V$   
 Operating junction temp. ( $T_J$ ) ..... -40°C to +125°C

**Thermal Resistance <sup>(4)</sup>**     $\theta_{JA}$      $\theta_{JC}$   
 TSOT23-8 ..... 100 ..... 55 ... °C/W

#### NOTES:

- Exceeding these ratings may damage the device.
- The maximum allowable power dissipation is a function of the maximum junction temperature  $T_J$  (MAX), the junction-to-ambient thermal resistance  $\theta_{JA}$ , and the ambient temperature  $T_A$ . The maximum allowable continuous power dissipation at any ambient temperature is calculated by  $P_D$  (MAX) =  $(T_J$  (MAX) -  $T_A$ ) /  $\theta_{JA}$ . Exceeding the maximum allowable power dissipation produces an excessive die temperature, causing the device to go into thermal shutdown. Internal thermal shutdown circuitry protects the device from permanent damage.
- The device is not guaranteed to function outside of its operating conditions.
- Measured on JESD51-7, 4-layer PCB.

## ELECTRICAL CHARACTERISTICS

$V_{IN} = 5V$ ,  $T_J = -40^{\circ}C$  to  $+125^{\circ}C$ , unless otherwise noted, typical values are at  $T_J = +25^{\circ}C$ .

Parameter	Symbol	Condition	Min	Typ	Max	Units
Quiescent current	$I_Q$	$V_{IN} = 5V$ , $V_{EN} = 2V$ , $V_{FB} = 0.63V$ , no switching		520	720	$\mu A$
Supply current (shutdown)	$I_{SHDN}$	$V_{EN} = 0V$ , $T_J = +25^{\circ}C$		0.1	2	$\mu A$
		$V_{EN} = 0V$ , $T_J = -40^{\circ}C$ to $+125^{\circ}C$		0.1	35	
Feedback voltage	$V_{FB}$	$T_J = +25^{\circ}C$	591	600	609	mV
		$T_J = -40^{\circ}C$ to $+125^{\circ}C$	588	600	612	
Feedback current	$I_{FB}$	$V_{FB} = 0.63V$		10	100	nA
P-FET switch on resistance	$R_{DSON\_P}$			90	135	m $\Omega$
N-FET switch on resistance	$R_{DSON\_N}$			50	83	m $\Omega$
Switch leakage		$V_{EN} = 0V$ , $V_{IN} = 5V$ , $V_{SW} = 0V$ and $5V$ , $T_J = +25^{\circ}C$		0.1	2	$\mu A$
		$V_{EN} = 0V$ , $V_{IN} = 5V$ , $V_{SW} = 0V$ and $5V$ , $T_J = -40^{\circ}C$ to $+125^{\circ}C$		0.1	35	
P-FET current limit		$T_J = +25^{\circ}C$	3	4	6	A
On time	$t_{ON}$	$V_{IN} = 3.3V$ , $V_{OUT} = 1.2V$	135	150	180	ns
		$V_{IN} = 3.3V$ , $V_{OUT} = 1.8V$	190	210	270	
		$V_{IN} = 5V$ , $V_{OUT} = 1.2V$	95	110	130	
		$V_{IN} = 5V$ , $V_{OUT} = 1.8V$	130	150	190	
Switching frequency	$f_s$	$V_{IN} = 3.3V$ , $V_{OUT} = 1.2V$	1850	2400	2700	kHz
		$V_{IN} = 3.3V$ , $V_{OUT} = 1.8V$	2000	2600	2800	
		$V_{IN} = 5V$ , $V_{OUT} = 1.2V$	1850	2200	2500	
		$V_{IN} = 5V$ , $V_{OUT} = 1.8V$	1850	2380	2700	
Minimum off time	$t_{MIN-OFF}$	$V_{IN} = 3.3V$ , $V_{OUT} = 1.2V$		60	90	ns
		$V_{IN} = 3.3V$ , $V_{OUT} = 1.8V$				
		$V_{IN} = 5V$ , $V_{OUT} = 1.2V$		30	50	ns
		$V_{IN} = 5V$ , $V_{OUT} = 1.8V$				
Soft-start time <sup>(5)</sup>	$t_{SS-ON}$	$V_{IN} = 3.6V$ , $V_{OUT} = 1.5V$ , 10% to 90%	0.6	1.3	2.2	ms
Soft-stop time <sup>(5)</sup>	$t_{SS-OFF}$	$V_{IN} = 3.6V$ , $V_{OUT} = 1.5V$ , 90% to 10%	0.4	0.9	1.6	ms
Power good upper trip threshold rising	$PG_{H-R}$	FB rising when PG turns to high voltage	110	115	120	%
Power good upper trip threshold falling	$PG_{H-F}$	FB falling when PG turns to high voltage	105	110	115	%
Power good upper trip hysteresis	$PG_{H-Hys}$			5		%
Power good lower trip threshold rising	$PG_{L-R}$	FB rising when PG turns to high voltage	85	90	95	%
Power good lower trip threshold falling	$PG_{L-F}$	FB falling when PG turns to high voltage	80	85	90	%
Power good lower trip hysteresis	$PG_{L-Hys}$			5		%

**ELECTRICAL CHARACTERISTICS (continued)**

$V_{IN} = 5V$ ,  $T_J = -40^{\circ}C$  to  $+125^{\circ}C$ , unless otherwise noted, typical values are at  $T_J = +25^{\circ}C$ .

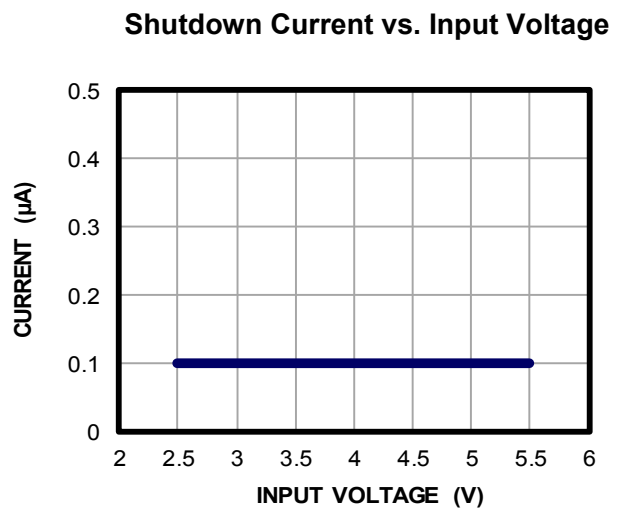
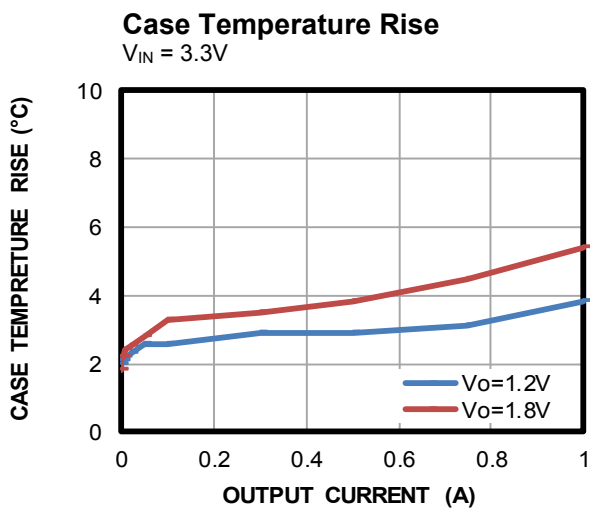
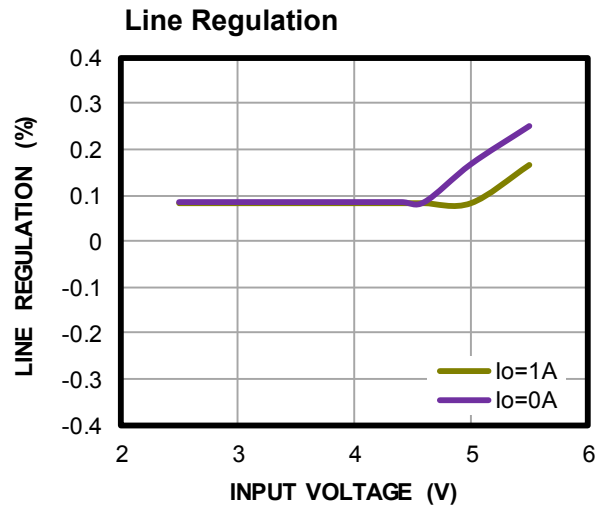
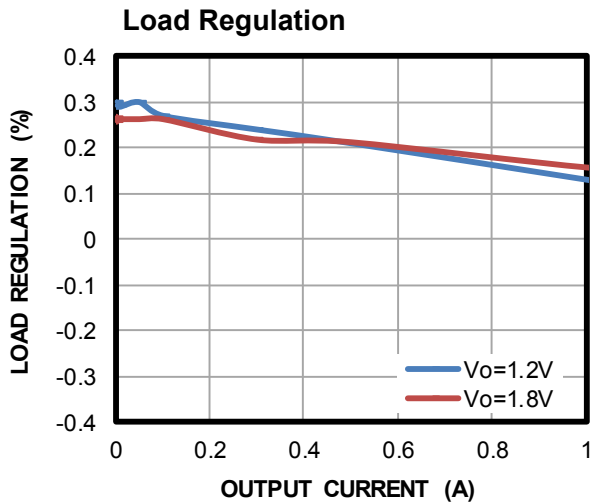
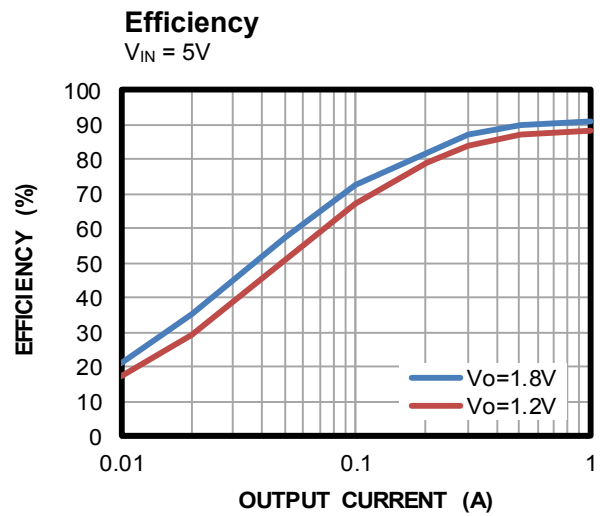
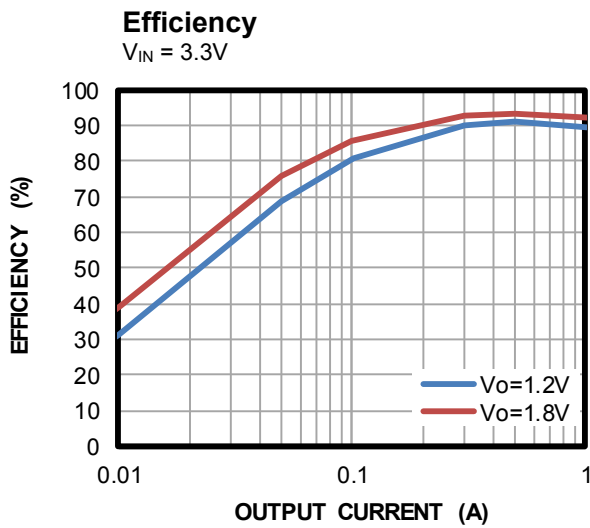
Parameter	Symbol	Condition	Min	Typ	Max	Units
Power good delay	PG <sub>D</sub>		30	110	200	μs
Power good sink current capability	V <sub>PG-L</sub>	Sink 1mA		250	400	mV
Power good logic high voltage	V <sub>PG-H</sub>	$V_{IN} = 5V$ , $V_{FB} = 0.6V$	4.85			V
Power good internal pull-up resistor	R <sub>PG</sub>		200	500	800	kΩ
Under-voltage lockout threshold rising			2.0	2.2	2.4	V
Under-voltage lockout threshold hysteresis				150		mV
EN input logic low voltage					0.4	V
EN input logic high voltage			1.2			V
EN input current		$V_{EN} = 0V$		0.1	0.2	μA
		$V_{EN} = 2V$		2	4	μA
Thermal shutdown <sup>(5)</sup>				170		°C
Thermal hysteresis <sup>(5)</sup>				30		°C

**NOTE:**

5) Not tested in production and guaranteed by design and characterization.

### TYPICAL PERFORMANCE CHARACTERISTICS

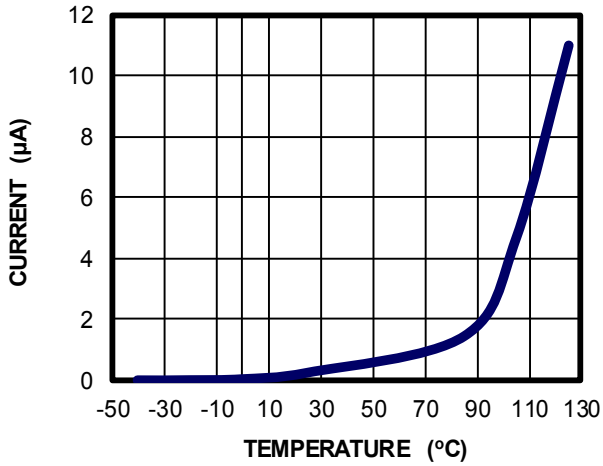
$V_{IN} = 3.3V$ ,  $V_{OUT} = 1.2V$ ,  $L = 1\mu H$ ,  $C_{OUT} = 22\mu F$ ,  $T_A = +25^\circ C$ , unless otherwise noted.



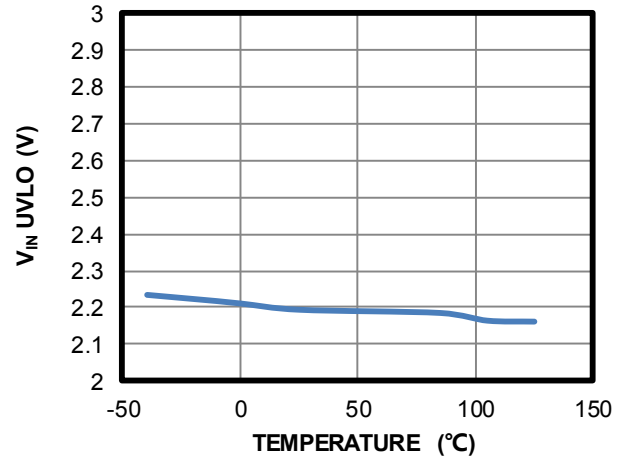
**TYPICAL PERFORMANCE CHARACTERISTICS** (continued)

$V_{IN} = 3.3V$ ,  $V_{OUT} = 1.2V$ ,  $L = 1\mu H$ ,  $C_{OUT} = 22\mu F$ ,  $T_A = +25^\circ C$ , unless otherwise noted.

Shutdown Current vs. Temperature



$V_{IN}$  UVLO vs. Temperature

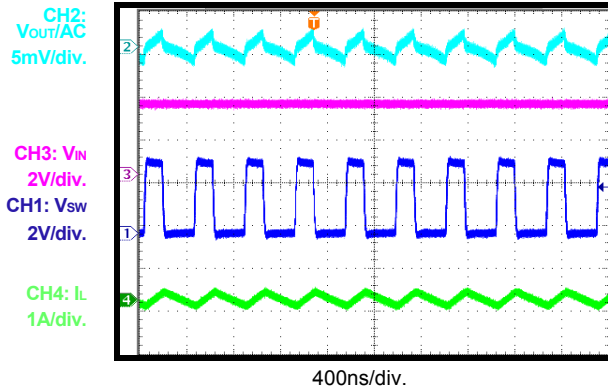


**TYPICAL PERFORMANCE CHARACTERISTICS (continued)**

$V_{IN} = 3.3V$ ,  $V_{OUT} = 1.2V$ ,  $L = 1\mu H$ ,  $C_{OUT} = 22\mu F$ ,  $T_A = +25^\circ C$ , unless otherwise noted.

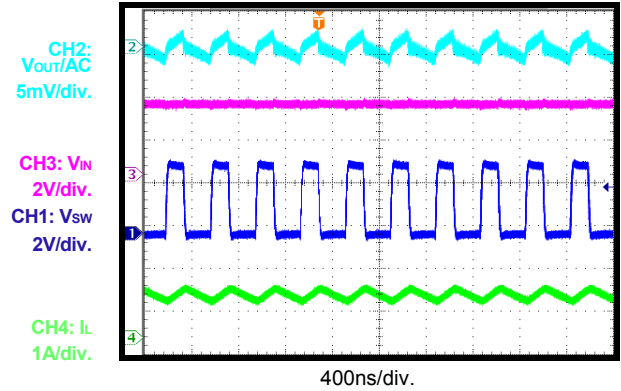
**Output Ripple**

$I_{OUT} = 0A$



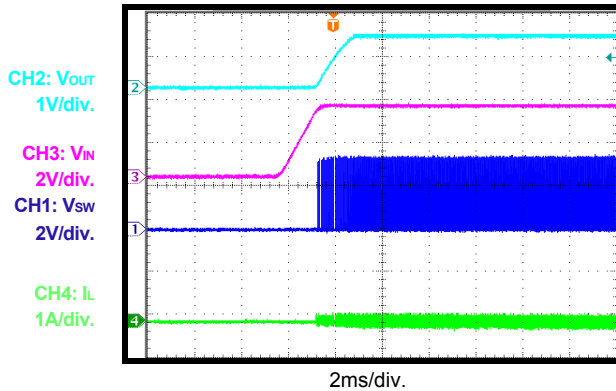
**Output Ripple**

$I_{OUT} = 1A$



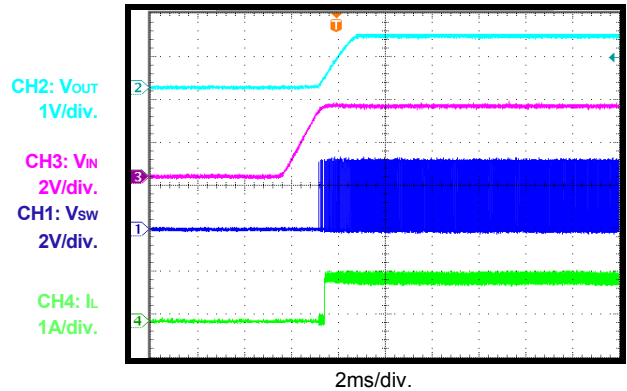
**Start-Up through  $V_{IN}$**

$I_{OUT} = 0A$



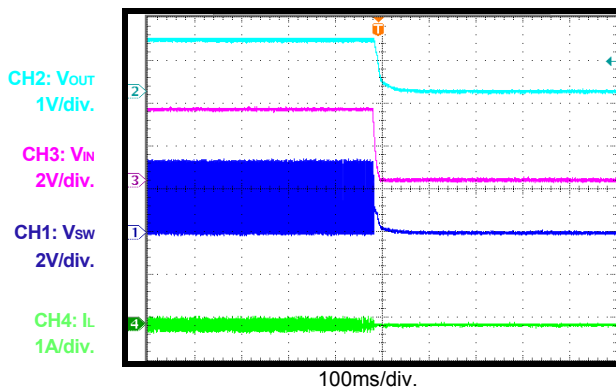
**Start-Up through  $V_{IN}$**

$I_{OUT} = 1A$



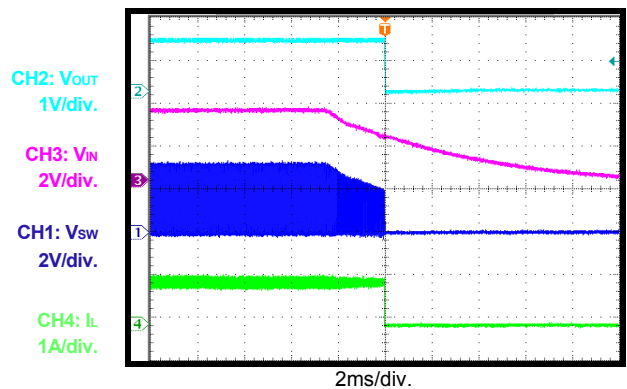
**Shutdown through  $V_{IN}$**

$I_{OUT} = 0A$



**Shutdown through  $V_{IN}$**

$I_{OUT} = 1A$

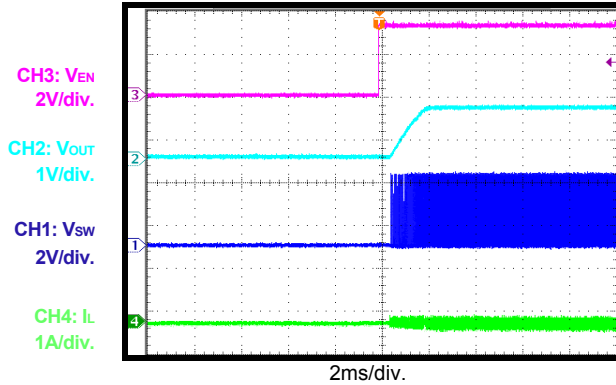


**TYPICAL PERFORMANCE CHARACTERISTICS (continued)**

$V_{IN} = 3.3V$ ,  $V_{OUT} = 1.2V$ ,  $L = 1\mu H$ ,  $C_{OUT} = 22\mu F$ ,  $T_A = +25^\circ C$ , unless otherwise noted.

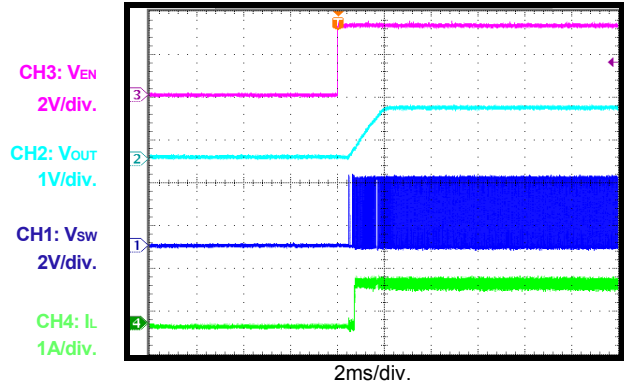
**Start-Up through EN**

$I_{OUT} = 0A$



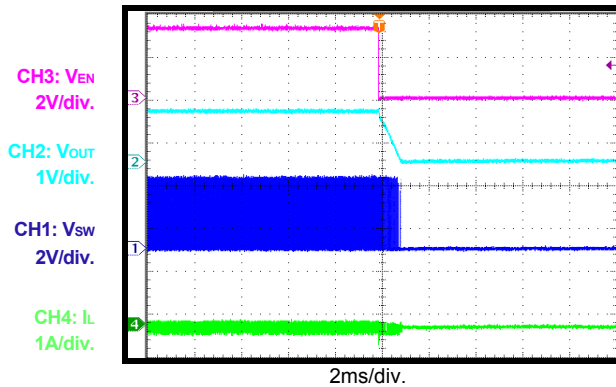
**Start-Up through EN**

$I_{OUT} = 1A$



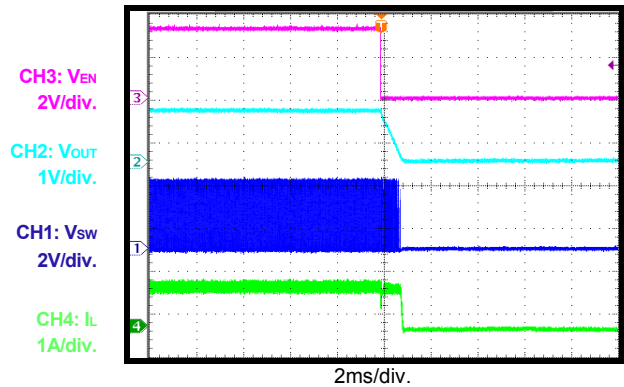
**Shutdown through EN**

$I_{OUT} = 0A$



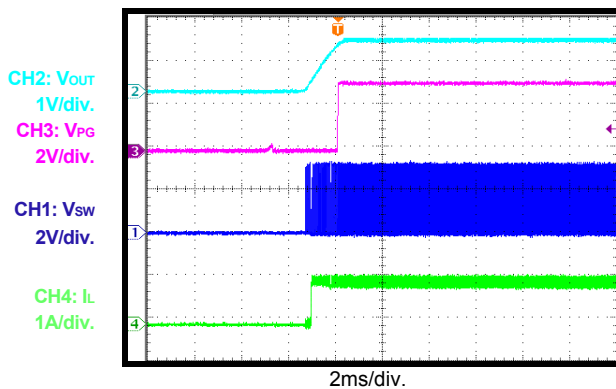
**Shutdown through EN**

$I_{OUT} = 1A$



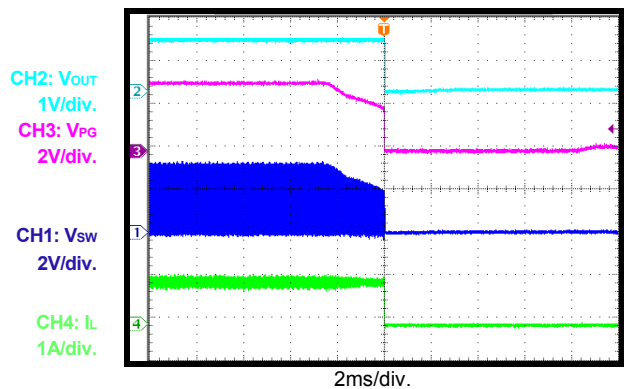
**PG in Start-Up through  $V_{IN}$**

$I_{OUT} = 1A$



**PG in Shutdown through  $V_{IN}$**

$I_{OUT} = 1A$



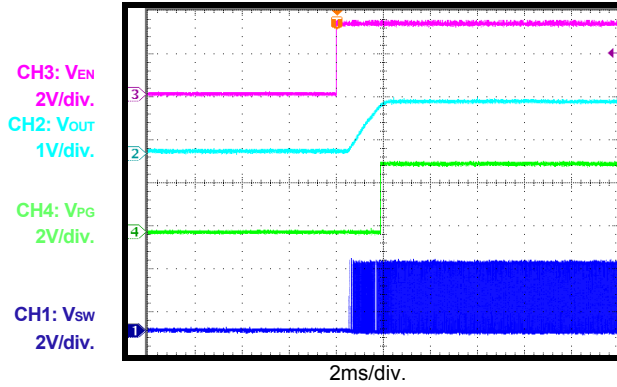


**TYPICAL PERFORMANCE CHARACTERISTICS (continued)**

$V_{IN} = 3.3V$ ,  $V_{OUT} = 1.2V$ ,  $L = 1\mu H$ ,  $C_{OUT} = 22\mu F$ ,  $T_A = +25^\circ C$ , unless otherwise noted.

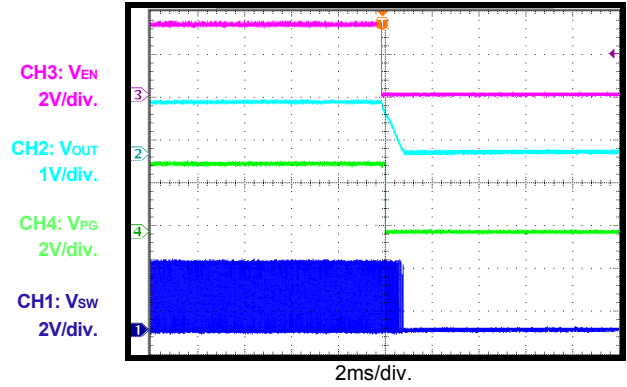
**PG in Start-Up through EN**

$I_{OUT} = 1A$



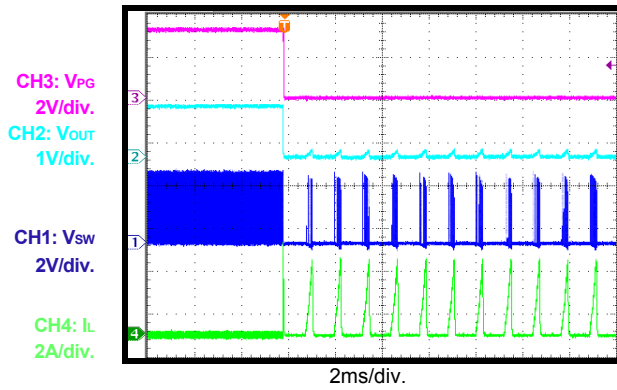
**PG in Shutdown through EN**

$I_{OUT} = 1A$



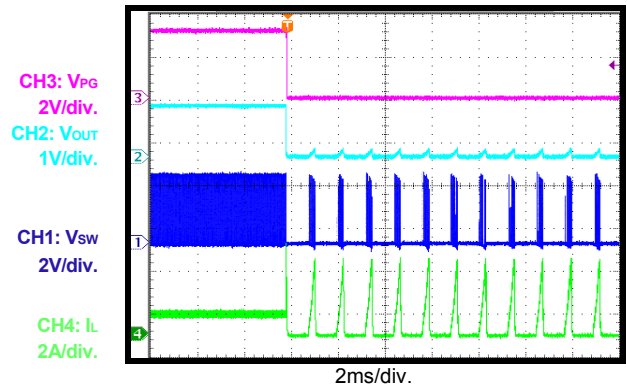
**SCP Entry**

$I_{OUT} = 0A$



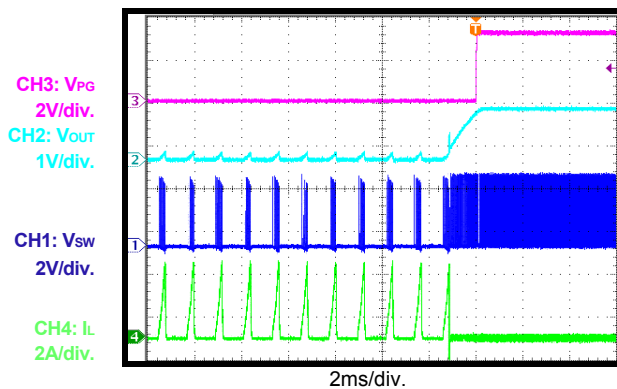
**SCP Entry**

$I_{OUT} = 1A$



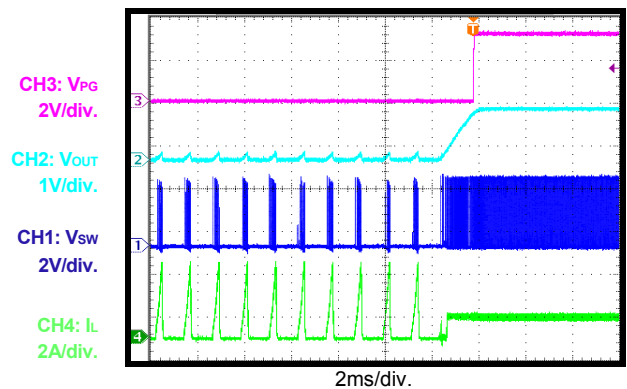
**SCP Recovery**

$I_{OUT} = 0A$



**SCP Recovery**

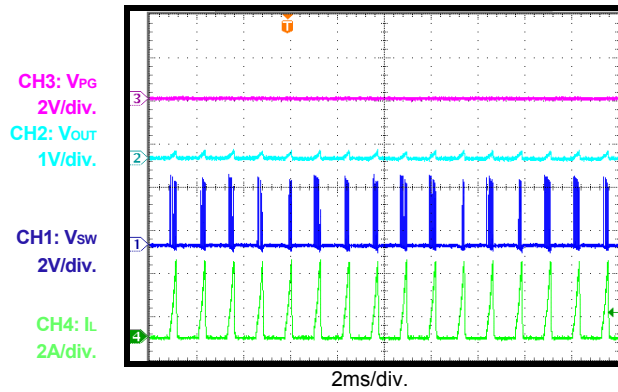
$I_{OUT} = 1A$



**TYPICAL PERFORMANCE CHARACTERISTICS (continued)**

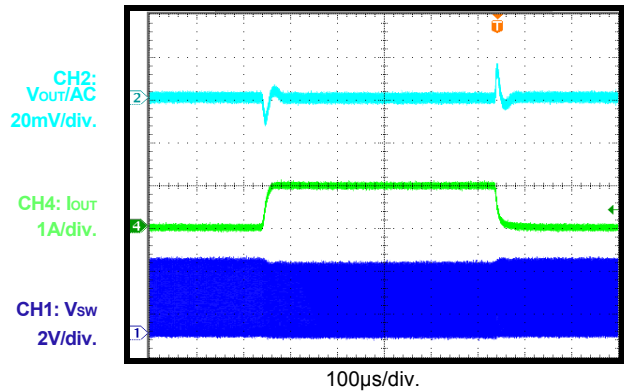
$V_{IN} = 3.3V$ ,  $V_{OUT} = 1.2V$ ,  $L = 1\mu H$ ,  $C_{OUT} = 22\mu F$ ,  $T_A = +25^\circ C$ , unless otherwise noted.

**SCP Steady State**



**Load Transient Response**

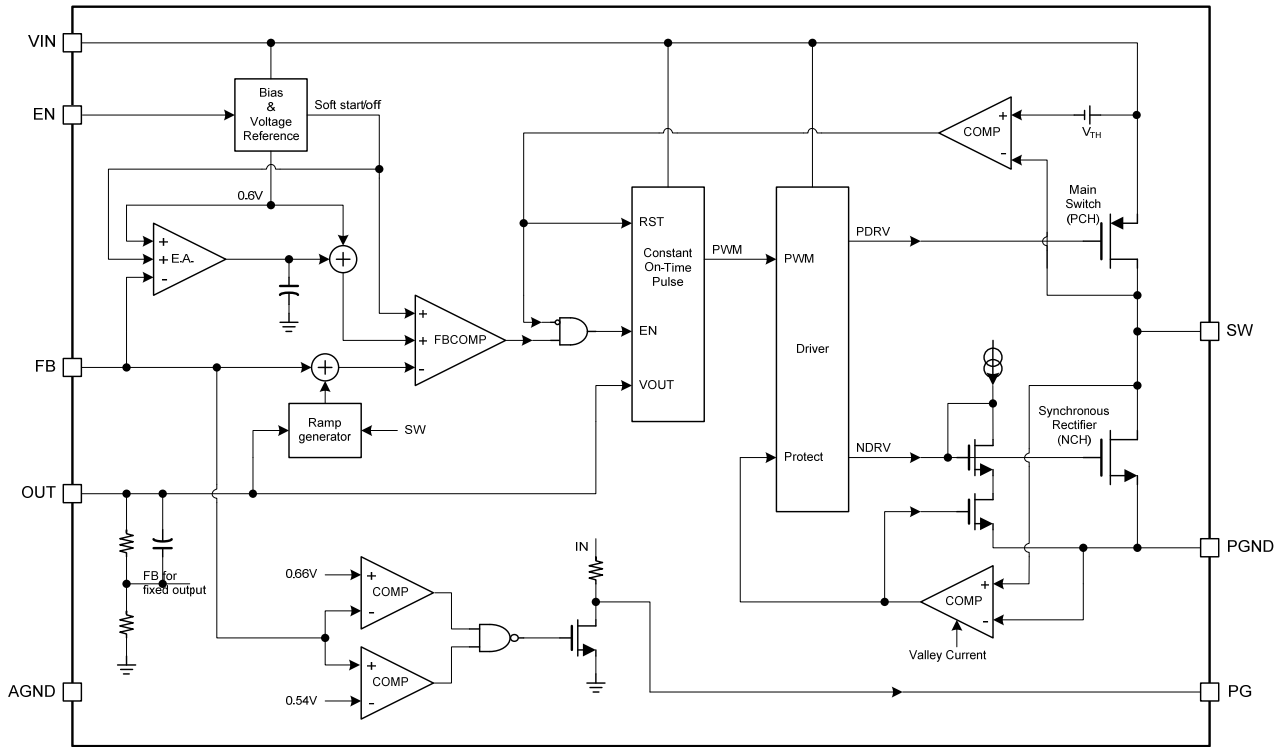
$I_{OUT} = 0 - 1A$



## PIN FUNCTIONS

Package Pin #	Name	Description
1	PG	<b>Power good indicator.</b> The output of PG is an open drain that connects to VIN via an internal pull-up resistor. PG goes high if the output voltage is within $\pm 10\%$ of the nominal voltage.
2	VIN	<b>Input supply.</b> The MPQ2171 operates from a 2.5V to 5.5V input rail. A capacitor (C1) prevents large voltage spikes from appearing at the input.
3	SW	<b>Switch output.</b> SW is the output of the internal power switch.
4	PGND	<b>Power ground.</b> PGND is the reference ground of the power device and requires careful consideration during PCB layout. For best results, connect PGND with copper pours and vias.
5	OUT	<b>Input sense.</b> OUT is for the output voltage feedback.
6	AGND	<b>Analog ground.</b> AGND is the reference ground of the internal control circuit.
7	FB	<b>Feedback.</b> Connect FB to the tap of an external resistor divider from the output to AGND to set the output voltage.
8	EN	<b>Enable.</b> Pull EN high to enable the MPQ2171. Float EN or connect EN to ground to disable the MPQ2171.

**BLOCK DIAGRAM**



**Figure 1: Functional Block Diagram**

## OPERATION

The MPQ2171 uses constant-on-time (COT) control with input voltage feed-forward to stabilize the switching frequency over its entire input range. The MPQ2171 achieves up to 1A of continuous output current from a 2.5V to 5.5V input voltage with excellent load and line regulation. The output voltage can be regulated as low as 0.6V.

### Constant-On-Time (COT) Control

Compared to fixed-frequency pulse-width modulation (PWM) control, constant-on-time (COT) control offers a simpler control loop and faster transient response. By using input voltage feed-forward, the MPQ2171 maintains a nearly constant switching frequency across the entire input and output voltage range. The switching pulse on time can be estimated with Equation (1):

$$T_{on}(\mu s) = V_{OUT}/V_{IN} \times 0.33 + 0.03\mu s \quad (1)$$

Where 0.03 $\mu$ s is the loop delay.

For the specific value of the on time, refer to the EC table on page 3.

To prevent inductor current runaway during the load transient, the MPQ2171 implements a minimum off time in each cycle. This minimum off time limit does not affect the operation of the MPQ2171 in steady state in any way.

### Enable (EN)

When the input voltage exceeds the under-voltage lockout (UVLO) threshold (typically 2.2V) the MPQ2171 is enabled by pulling the enable pin (EN) above 1.2V. Float EN or connect EN to ground to disable the MPQ2171. There is an internal 1M $\Omega$  resistor from EN to ground.

### Soft-Start/Soft-Stop

The MPQ2171 has a built-in soft start that ramps up the output voltage at a constant slew rate to avoid overshooting during start-up. The soft-start time is about 1.3ms, typically. When disabled, the MPQ2171 ramps down the internal reference voltage to allow the load to discharge the output linearly.

### Power Good (PG) Indicator

The MPQ2171 has an open drain with a 500k $\Omega$  pull-up resistor pin for power good indication (PG). When FB is within  $\pm 10\%$  of the regulation voltage (0.6V), PG is pulled up to VIN by the internal resistor. If the FB voltage is outside the  $\pm 10\%$  window, PG is pulled to ground by an internal MOSFET.

### Current Limit

The MPQ2171 has a 4A current limit for the high-side switch (HS-FET). When the HS-FET reaches its current limit, the MPQ2171 enters hiccup mode until the current drops to prevent the inductor current from building and damaging the components.

### Short Circuit and Recovery

The MPQ2171 enters short-circuit protection (SCP) mode when it reaches the current limit and attempts to recover from the short circuit with hiccup mode. In SCP, the MPQ2171 disables the output power stage, discharges a soft-start capacitor, and then enacts a soft-start procedure. If the short-circuit condition still remains after the soft-start ends, the MPQ2171 repeats this operation until the short circuit is removed and the output rises back to the regulation level.

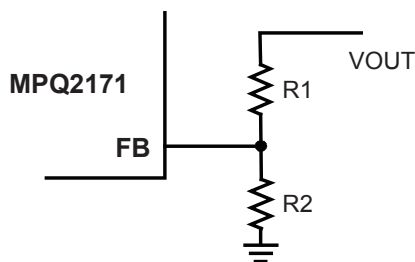
## APPLICATION INFORMATION

### Setting the Output Voltage

The external resistor divider sets the output voltage. The feedback resistor (R1) must account for both stability and dynamic response and therefore cannot be too large or too small. Choose R1 to be around 41.2kΩ. R2 can then be calculated with Equation (2):

$$R2 = \frac{R1}{\frac{V_{out}}{0.6} - 1} \quad (2)$$

The feedback circuit is shown in Figure 2.



**Figure 2: Feedback Network**

Table 1 lists the recommended resistor values for common output voltages.

**Table 1: Resistor Values for Common Output Voltages**

V <sub>OUT</sub> (V)	R1 (kΩ)	R2 (kΩ)
1.0	41.2 (1%)	60.4 (1%)
1.2	41.2 (1%)	41.2 (1%)
1.8	41.2 (1%)	20.5 (1%)
3.3	41.2 (1%)	9.09 (1%)

### Selecting the Inductor

A 0.47 - 1.5μH inductor is recommended for most applications. For the highest efficiency, choose an inductor with a DC resistance less than 15mΩ. For most designs, the inductance value can be derived from Equation (3):

$$L_1 = \frac{V_{OUT} \times (V_{IN} - V_{OUT})}{V_{IN} \times \Delta I_L \times f_{OSC}} \quad (3)$$

Where ΔI<sub>L</sub> is the inductor ripple current.

Choose the inductor current to be approximately 30% of the maximum load current. The maximum inductor peak current can be calculated with Equation (4):

$$I_{L(MAX)} = I_{LOAD} + \frac{\Delta I_L}{2} \quad (4)$$

### Selecting the Input Capacitor

The input current to the step-down converter is discontinuous and therefore requires a capacitor to supply AC current to the step-down converter while maintaining the DC input voltage. Use low ESR capacitors for the best performance. Ceramic capacitors with X5R or X7R dielectrics are highly recommended because of their low ESR values and small temperature coefficients. For most applications, a 10μF capacitor is sufficient. For higher output voltages, use a 47μF capacitor to improve system stability.

Since the input capacitor absorbs the input switching current, it requires an adequate ripple current rating. The RMS current in the input capacitor can be estimated with Equation (5):

$$I_{C1} = I_{LOAD} \times \sqrt{\frac{V_{OUT}}{V_{IN}} \times \left(1 - \frac{V_{OUT}}{V_{IN}}\right)} \quad (5)$$

The worst-case condition occurs at V<sub>IN</sub> = 2V<sub>OUT</sub>, shown in Equation (6):

$$I_{C1} = \frac{I_{LOAD}}{2} \quad (6)$$

For simplification, choose an input capacitor with an RMS current rating greater than half of the maximum load current.

The input capacitor can be electrolytic, tantalum, or ceramic. When using electrolytic or tantalum capacitors, place a small, high-quality, ceramic capacitor (0.1μF) as close to the IC as possible. When using ceramic capacitors, ensure that they have enough capacitance to prevent excessive voltage ripple at the input. The input voltage ripple caused by the capacitance can be estimated with Equation (7):

$$\Delta V_{IN} = \frac{I_{LOAD}}{f_s \times C1} \times \frac{V_{OUT}}{V_{IN}} \times \left(1 - \frac{V_{OUT}}{V_{IN}}\right) \quad (7)$$

### Selecting the Output Capacitor

The output capacitor (C2) maintains the output DC voltage. Use low ESR, ceramic capacitors to keep the output voltage ripple low. The output voltage ripple can be estimated with Equation (8):

$$\Delta V_{OUT} = \frac{V_{OUT}}{f_s \times L_1} \times \left(1 - \frac{V_{OUT}}{V_{IN}}\right) \times \left(R_{ESR} + \frac{1}{8 \times f_s \times C2}\right) \quad (8)$$

Where  $L_1$  is the inductor value, and  $R_{ESR}$  is the equivalent series resistance of the output capacitor.

For ceramic capacitors, the impedance at the switching frequency is dominated by the capacitance. The output voltage ripple is caused mainly by the capacitance. For simplification, the output voltage ripple can be estimated with Equation (9):

$$\Delta V_{OUT} = \frac{V_{OUT}}{8 \times f_s^2 \times L_1 \times C2} \times \left(1 - \frac{V_{OUT}}{V_{IN}}\right) \quad (9)$$

For tantalum or electrolytic capacitors, the ESR dominates the impedance at the switching frequency. For simplification, the output ripple can be approximated with Equation (10):

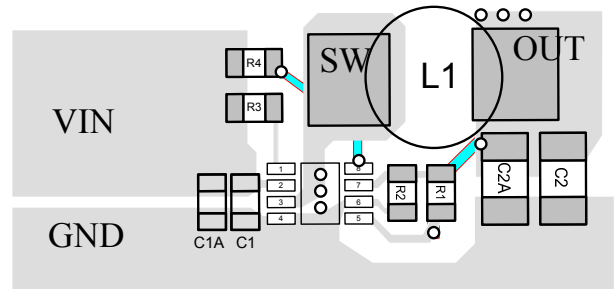
$$\Delta V_{OUT} = \frac{V_{OUT}}{f_s \times L_1} \times \left(1 - \frac{V_{OUT}}{V_{IN}}\right) \times R_{ESR} \quad (10)$$

The characteristics of the output capacitor also affect the stability of the regulation system.

### PCB Layout Guidelines

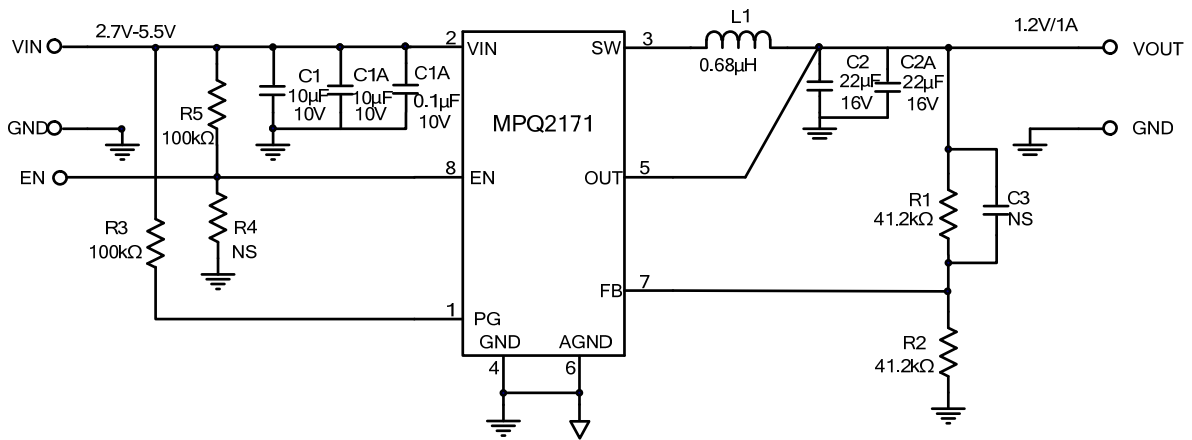
Proper layout of the switching power supplies is critical for stable operation. For high-frequency switching converters, a poor layout can lead to poor line or load regulation and stability issues. For best results, refer to Figure 3 and follow the guidelines below.

1. Place high current paths (GND, VIN, and SW) very close to the device using short, direct, and wide traces.
2. Place the input capacitor as close to VIN and GND as possible.
3. Place the external feedback resistors next to FB.
4. Keep the switching node SW short and away from the feedback network.

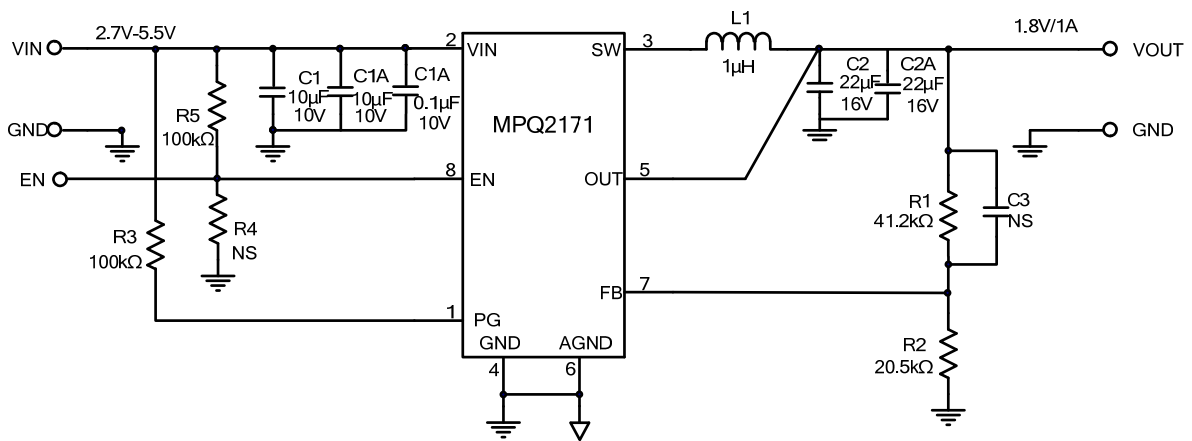


**Figure 3: Layout Recommendation**

**TYPICAL APPLICATION CIRCUITS**



**Figure 4: V<sub>OUT</sub> = 1.2V Typical Application Circuit**

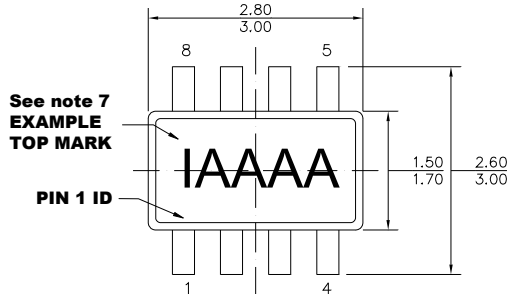


**Figure 5: V<sub>OUT</sub> = 1.8V Typical Application Circuit**

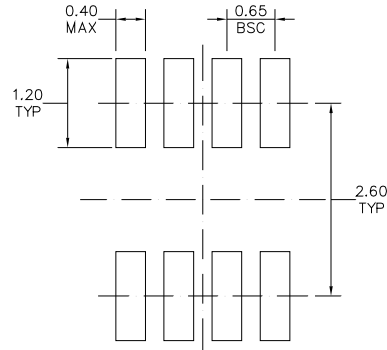


**PACKAGE INFORMATION**

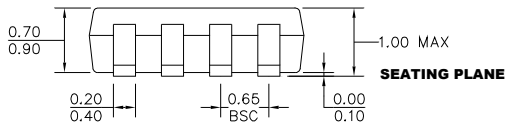
**TSOT23-8**



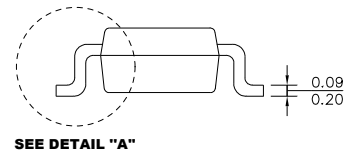
**TOP VIEW**



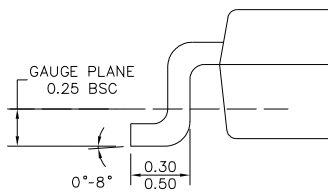
**RECOMMENDED LAND PATTERN**



**FRONT VIEW**



**SIDE VIEW**



**DETAIL "A"**

**NOTE:**

- 1) ALL DIMENSIONS ARE IN MILLIMETERS.
- 2) PACKAGE LENGTH DOES NOT INCLUDE MOLD FLASH, PROTRUSION OR GATE BURR.
- 3) PACKAGE WIDTH DOES NOT INCLUDE INTERLEAD FLASH OR PROTRUSION.
- 4) LEAD COPLANARITY (BOTTOM OF LEADS AFTER FORMING) SHALL BE 0.10 MILLIMETERS MAX.
- 5) JEDEC REFERENCE IS MO-193, VARIATION BA.
- 6) DRAWING IS NOT TO SCALE.
- 7) PIN 1 IS LOWER LEFT PIN WHEN READING TOP MARK FROM LEFT TO RIGHT, (SEE EXAMPLE TOP MARK)

**NOTICE:** The information in this document is subject to change without notice. Please contact MPS for current specifications. Users should warrant and guarantee that third party Intellectual Property rights are not infringed upon when integrating MPS products into any application. MPS will not assume any legal responsibility for any said applications.