



Summary

[Request a quote](#)

[Catalog](#)

Coax	1
Socket / Receptacle	Socket / Receptacle - Fixed Panel Front Mounted
Locking system	Push-pull

Technical details

Electrical Configuration

Coax	1
Contact Termination Coax	Solder
Insert configuration value	0A.250 - 1 Coax (50 Ohm)
Contact Type	Coaxial 50 Ohm (Solder)
Bucket Dia.	1.1

Form & Material

Shell style / Model id	ERN - Fixed receptacle with tag, nut fixing
Socket / Receptacle	Fixed Panel Front Mounted
Housing material	Brass (nickel plated [SAE AMS QQ N 290]) shell, collet nut, latch sleeve and mid pieces
Locking system	Push-pull
Keying	3 keys (alpha=42, gamma=30, plug: male contacts, receptacle: female contacts)
Weight	4.33 g

https://www.lemo.com/int_en/ern-0a-250-ntl.html

LEMO products and services are provided "as is". LEMO makes no warranties or representations with regard to LEMO product & services or use of them, express, implied or statutory, including for accuracy, completeness, or security. The user is fully responsible for his products and applications using LEMO components.

Environment

Environmental protection	IP50
Salt Spray Corrosion	>144 hr

Cable fixation

Cable termination protection	Standard back nut (no additional protection)
Fixation type	Cable collet

Drawings

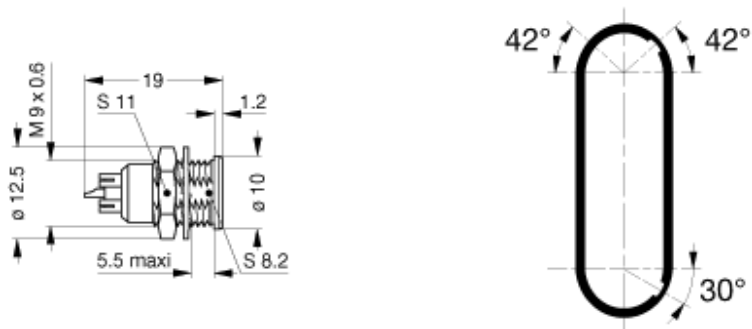

Dimensions

	A	B	e1	L	M	S1	S2	E _{max}
mm.	10	12.5	M9x0.6	19	1.2	8.2	11	5.5
in.	0.39	0.49		0.75	0.05	0.32	0.43	0.22

Recommended By Lemo













Accessories

Tools

https://www.lemo.com/int_en/ern-0a-250-ntl.html

LEMO products and services are provided "as is". LEMO makes no warranties or representations with regard to LEMO product & services or use of them, express, implied or statutory, including for accuracy, completeness, or security. The user is fully responsible for his products and applications using LEMO components.

Cables

Cable PartNumber	Material	Colour	Cable image
158480	PUR	Black	
158490	PVC	Black	
159580	PVC	Black	
17420	PVC	Black	
17450	COPOLYMER	Black	
178190	PTFE	Brown	
18000	PTFE	Brown	
18700	PTFE	White	
18800	PTFE	White	
196270	PTFE	White	
31600	PTFE	Brown	
62000	PVC	Black	
CCX.50.030.083.180B		white	
CCX.50.080.297538N	PVC	Black	
CCX.50.088.292495N	PVC	Black	
CCX.50.RG0.58AU14B	FEP	white	
CCX.50.RG0.58AU61J	PVC	Yellow	
CCX.50.RG1.74-U25N	PVC	Black	
CCX.50.RG1.74AU28N	PVC	Black	
CCX.50.RG1.74AU28N	PVC	Black	
CCX.50.RG1.74U25N	PVC	Black	
CCX.50.RG1.78BU18M	FEP	Brown	
CCX.50.RG1.78BU18M	PTFE	Brown	
CCX.50.RG1.88AU24B	TFE	white	
CCX.50.RG1.88AU26B	PFA	White	
CCX.50.RG1.88AU26B	PTFE	White	
CCX.50.RG1.96AU19B	PTFE	White	
CCX.50.RG1.96AU20B	PFA	White	
CCX.50.RG3.16BU26M	FEP	Brown	
CCX.50.RG3.16U28M	PTFE	Brown	
CCX.50.RG5.8CU50N	PVC	Black	
CCX.75.040.195327G	PVC	Grey	
CCX.75.RG0.59BU62N	PVC	Black	
CCX.75.RG1.79BU26M	FEP	Brown	
CCX.75.RG1.87AU26B	PFA	White	
CCX.75.RG1.87AU27B	PTFE	White	
CCX.93.RG0.62AU62N	PVC	Black	
CCX.95.RG1.80BU36M	PTFE	Brown	
CCX.95.RG1.95AU37B	PFA	White	

https://www.lemo.com/int_en/ern-0a-250-ntl.html

LEMO products and services are provided "as is". LEMO makes no warranties or representations with regard to LEMO product & services or use of them, express, implied or statutory, including for accuracy, completeness, or security. The user is fully responsible for his products and applications using LEMO components.